

BB501C

Build in Biasing Circuit MOS FET IC
UHF RF Amplifier

HITACHI

ADE-208-701D (Z)
5th. Edition
Mar. 2001

Features

- Build in Biasing Circuit; To reduce using parts cost & PC board space.
- High gain;
PG = 21.5 dB typ. at f = 900 MHz
- Low noise;
NF = 1.85 dB typ. at f = 900 MHz
- Withstanding to ESD;
Build in ESD absorbing diode. Withstand up to 200V at C=200pF, Rs=0 conditions.
- Provide mini mold packages; CMPAK-4(SOT-343mod)

Outline

CMPAK-4

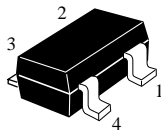

1. Source
2. Gate1
3. Gate2
4. Drain

- Notes:
1. Marking is "AS -".
 2. BB501C is individual type number of HITACHI BBFET.

BB501C

Absolute Maximum Ratings (Ta = 25°C)

Item	Symbol	Ratings	Unit
Drain to source voltage	V_{DS}	6	V
Gate1 to source voltage	V_{G1S}	+6 - 0	V
Gate2 to source voltage	V_{G2S}	+6 - 0	V
Drain current	I_D	20	mA
Channel power dissipation	Pch	100	mW
Channel temperature	Tch	150	°C
Storage temperature	Tstg	-55 to +150	°C

Electrical Characteristics (Ta = 25°C)

Item	Symbol	Min	Typ	Max	Unit	Test Conditions
Drain to source breakdown voltage	$V_{(BR)DSS}$	6	—	—	V	$I_D = 200\mu A$ $V_{G1S} = V_{G2S} = 0$
Gate1 to source breakdown voltage	$V_{(BR)G1SS}$	+6	—	—	V	$I_{G1} = +10\mu A$ $V_{G2S} = V_{DS} = 0$
Gate2 to source breakdown voltage	$V_{(BR)G2SS}$	+6	—	—	V	$I_{G2} = +10\mu A$ $V_{G1S} = V_{DS} = 0$
Gate1 to source cutoff current	I_{G1SS}	—	—	+100	nA	$V_{G1S} = +5V$ $V_{G2S} = V_{DS} = 0$
Gate2 to source cutoff current	I_{G2SS}	—	—	+100	nA	$V_{G2S} = +5V$ $V_{G1S} = V_{DS} = 0$
Gate1 to source cutoff voltage	$V_{G1S(off)}$	0.5	0.7	1.0	V	$V_{DS} = 5V, V_{G2S} = 4V$ $I_D = 100\mu A$
Gate2 to source cutoff voltage	$V_{G2S(off)}$	0.5	0.7	1.0	V	$V_{DS} = 5V, V_{G1S} = 5V$ $I_D = 100\mu A$
Drain current	$I_{D(op)}$	7	10	13	mA	$V_{DS} = 5V, V_{G1} = 5V$ $V_{G2S} = 4V, R_G = 47k\Omega$
Forward transfer admittance	$ y_{fs} $	19	24	29	mS	$V_{DS} = 5V, V_{G1} = 5V$ $V_{G2S} = 4V$ $R_G = 47k\Omega, f = 1kHz$
Input capacitance	C_{iss}	1.4	1.7	2.0	pF	$V_{DS} = 5V, V_{G1} = 5V$
Output capacitance	C_{oss}	0.7	1.1	1.5	pF	$V_{G2S} = 4V, R_G = 47k\Omega$
Reverse transfer capacitance	C_{rss}	—	0.019	0.04	pF	$f = 1MHz$
Power gain	PG	17	21.5	—	dB	$V_{DS} = 5V, V_{G1} = 5V$ $V_{G2S} = 4V, R_G = 47k\Omega$
Noise figure	NF	—	1.85	2.4	dB	$f = 900MHz$

Main Characteristics

900MHz Power Gain, Noise Figure Test Circuit

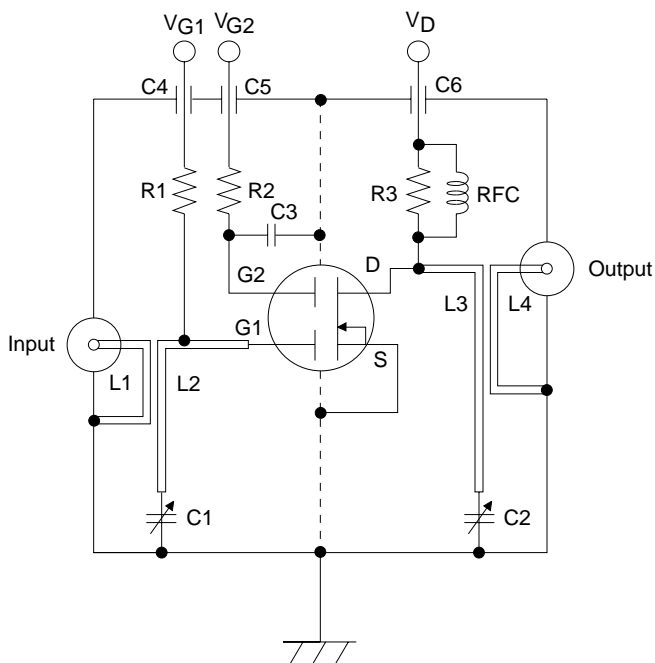

- C1, C2 : Variable Capacitor (10pF MAX)
- C3 : Disk Capacitor (1000pF)
- C4 to C6 : Air Capacitor (1000pF)
- R1 : 47 k Ω
- R2 : 47 k Ω
- R3 : 4.7 k Ω

L1 :

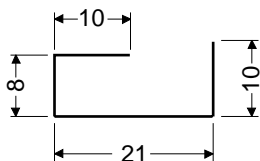

L2 :

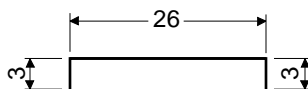

(ϕ 1mm Copper wire)
Unit : mm

L3 :

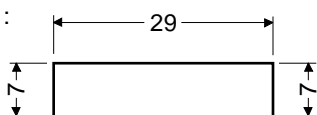

L4 :

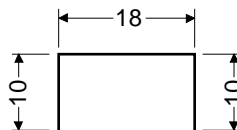

RFC : ϕ 1mm Copper wire with enamel 4turns inside dia 6mm

Maximum Channel Power
Dissipation Curve

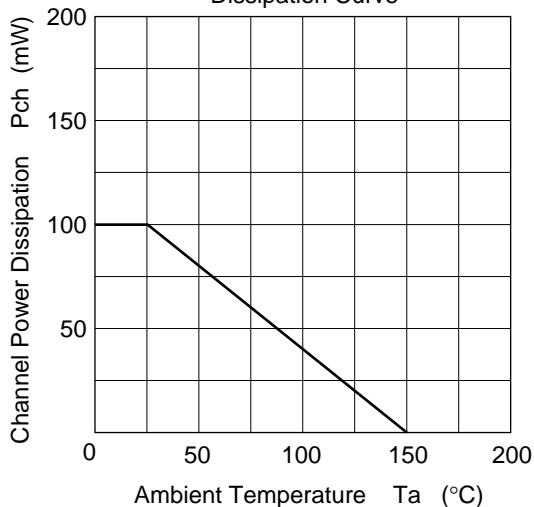

Typical Output Characteristics

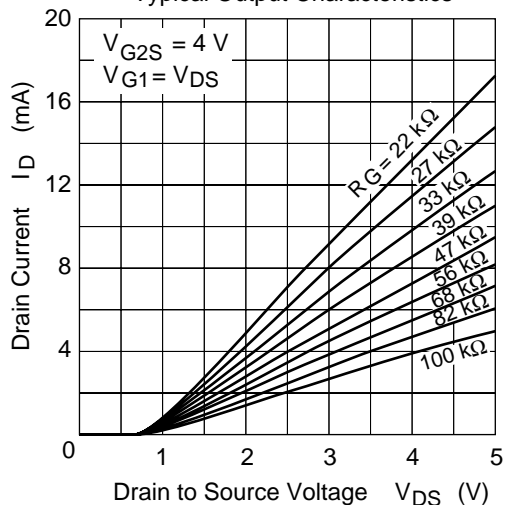

Drain Current vs. Gate1 Voltage

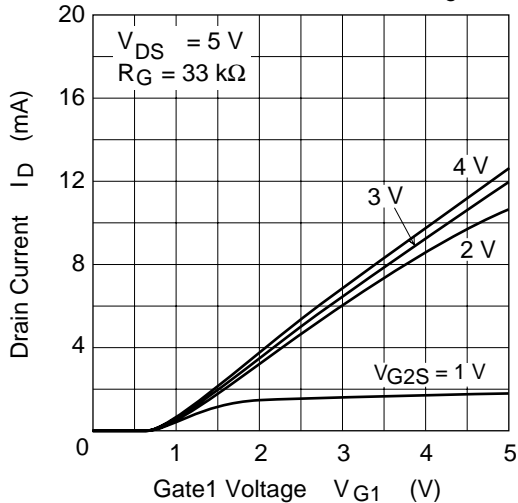

Drain Current vs. Gate1 Voltage

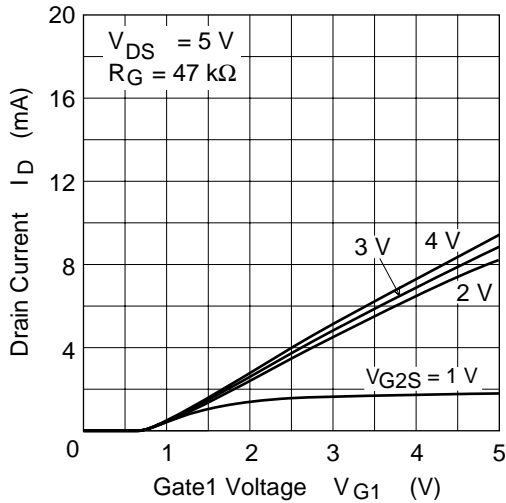

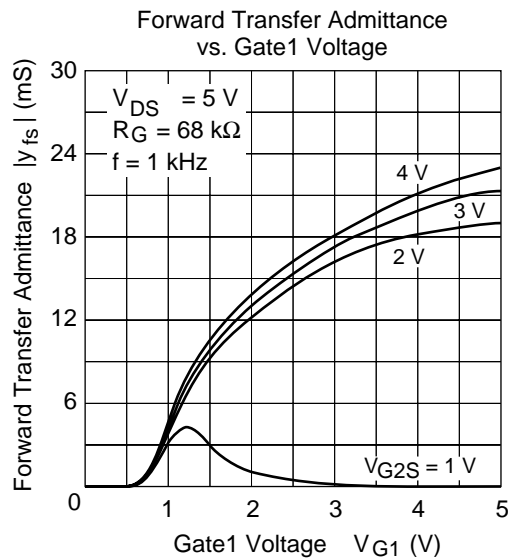
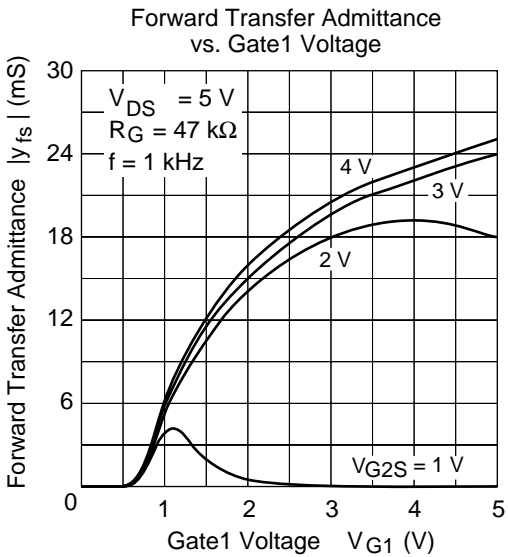
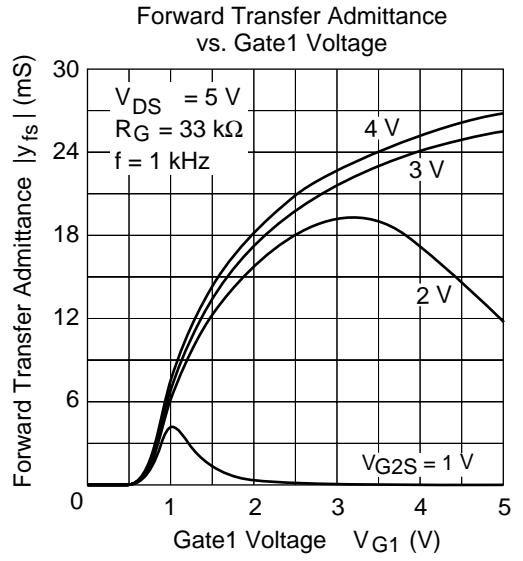
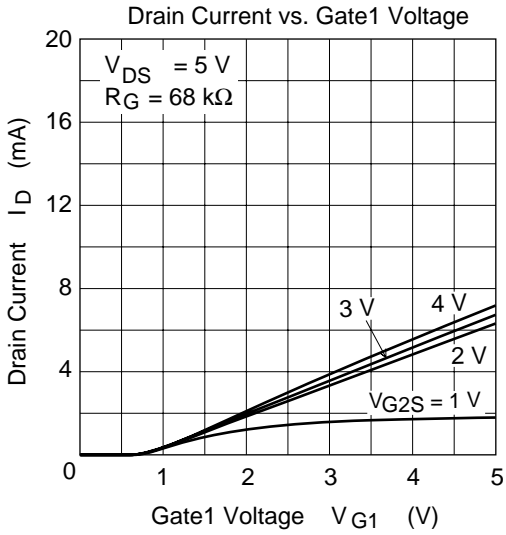

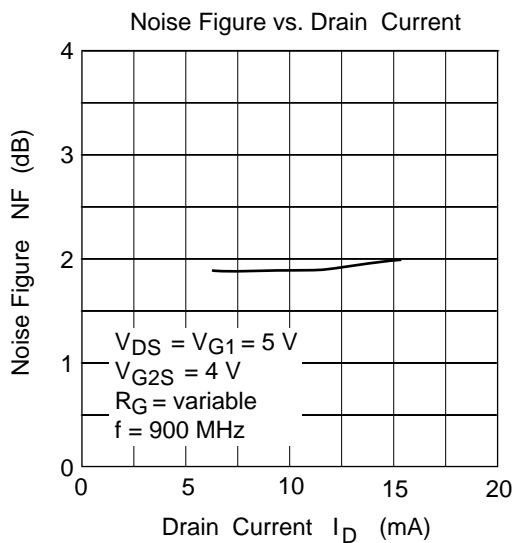
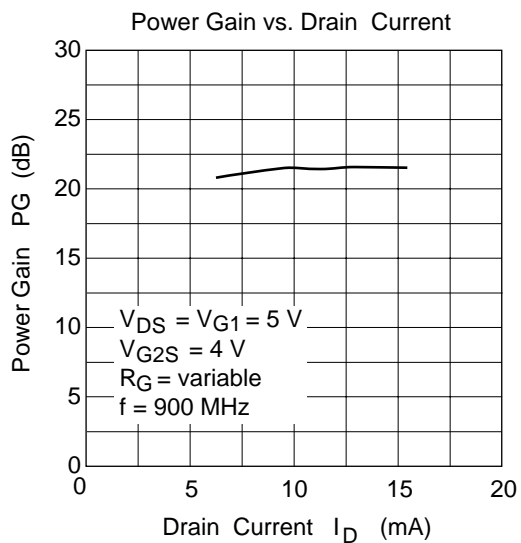
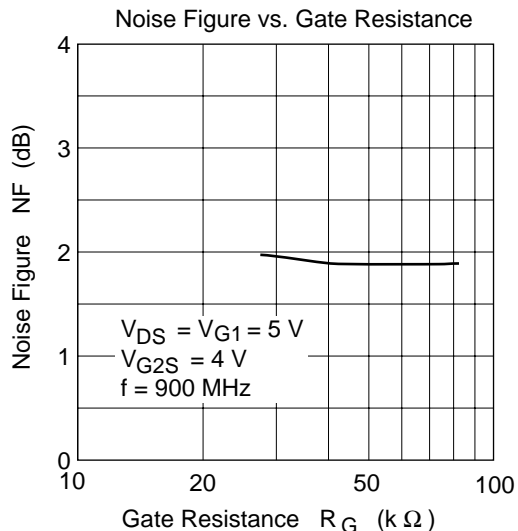
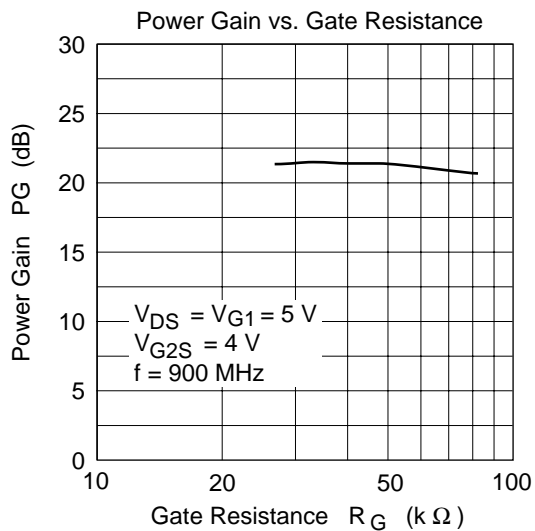

Drain Current vs. Gate Resistance

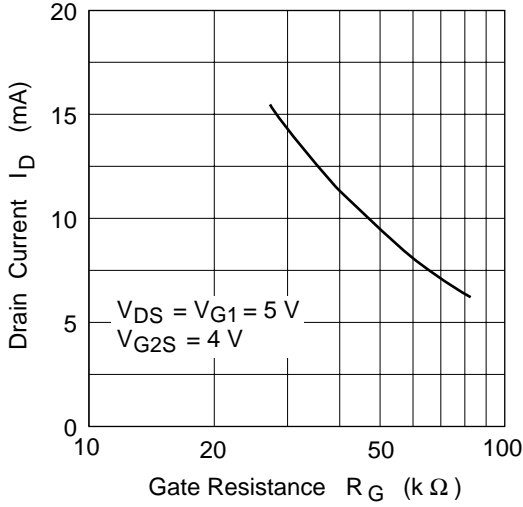

Power Gain vs. Gate2 to Source Voltage

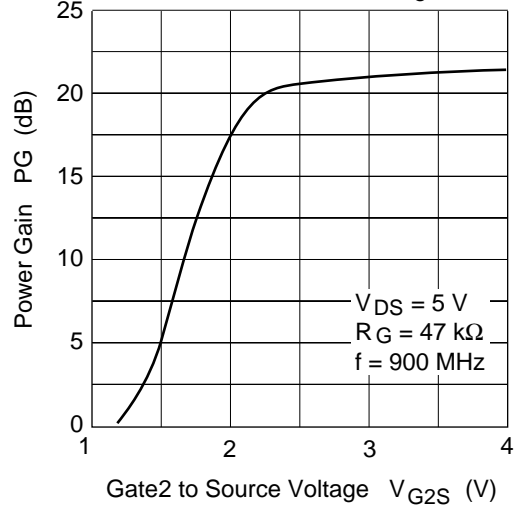

Noise Figure vs. Gate2 to Source Voltage

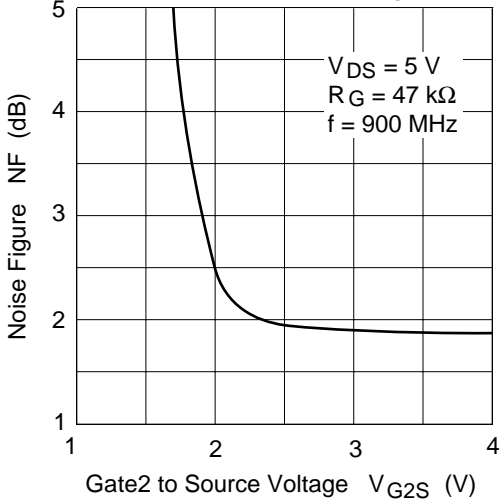

Input Capacitance vs. Gate2 to Source Voltage

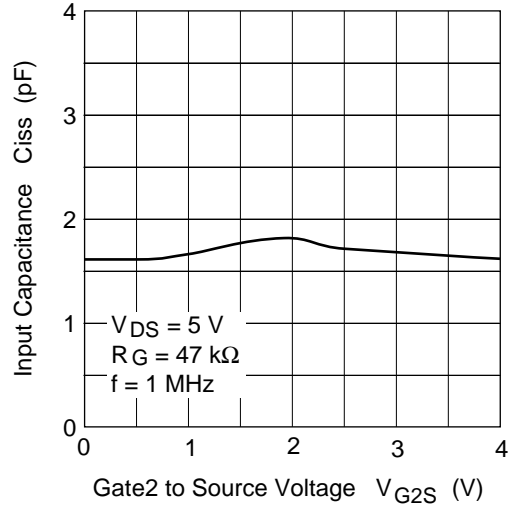

Gain Reduction vs.
Gate2 to Source Voltage

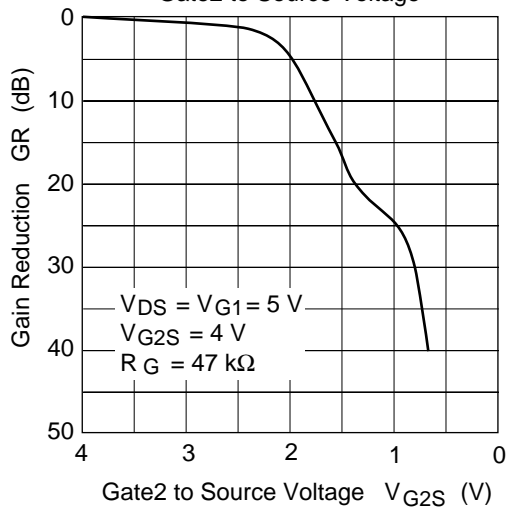

S11 Parameter vs. Frequency

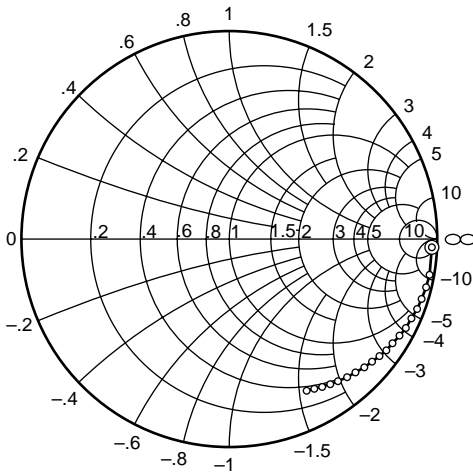

Test Condition: $V_{DS} = 5\text{ V}$, $V_{G1} = 5\text{ V}$
 $V_{G2S} = 4\text{ V}$, $R_G = 47\text{ k}\Omega$,
 $Z_o = 50\ \Omega$

50 to 1000 MHz (50 MHz step)



S21 Parameter vs. Frequency

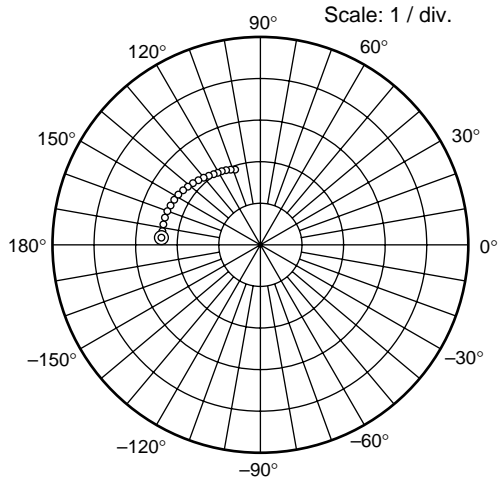

Test Condition: $V_{DS} = 5\text{ V}$, $V_{G1} = 5\text{ V}$
 $V_{G2S} = 4\text{ V}$, $R_G = 47\text{ k}\Omega$,
 $Z_o = 50\ \Omega$

50 to 1000 MHz (50 MHz step)



S12 Parameter vs. Frequency

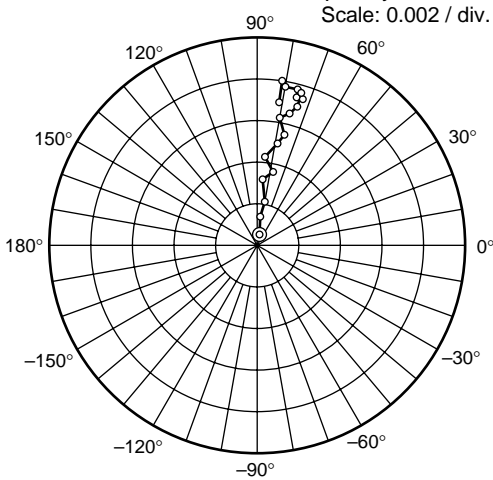

Test Condition: $V_{DS} = 5\text{ V}$, $V_{G1} = 5\text{ V}$
 $V_{G2S} = 4\text{ V}$, $R_G = 47\text{ k}\Omega$,
 $Z_o = 50\ \Omega$

50 to 1000 MHz (50 MHz step)



S22 Parameter vs. Frequency

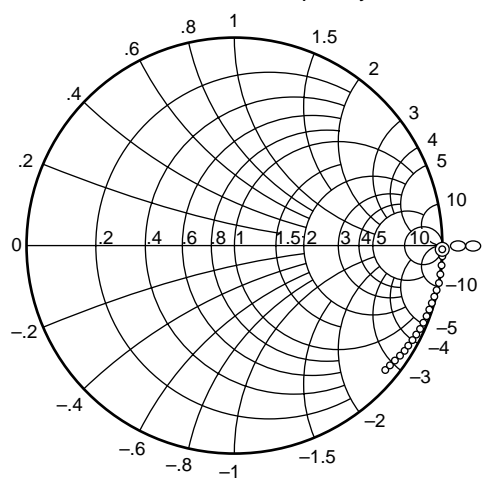

Test Condition: $V_{DS} = 5\text{ V}$, $V_{G1} = 5\text{ V}$
 $V_{G2S} = 4\text{ V}$, $R_G = 47\text{ k}\Omega$,
 $Z_o = 50\ \Omega$

50 to 1000 MHz (50 MHz step)



Sparameter ($V_{DS} = V_{G1} = 5V$, $V_{G2S} = 4V$, $R_G = 47k\Omega$, $Z_O = 50\Omega$)

f (MHz)	S11		S21		S12		S22	
	MAG	ANG	MAG	ANG	MAG	ANG	MAG	ANG
50	0.974	-2.8	2.40	176.4	0.00057	78.1	0.997	-2.0
100	0.974	-10.0	2.38	172.2	0.00144	82.4	0.998	-4.2
150	0.974	-13.6	2.38	168.4	0.00211	78.7	0.997	-6.0
200	0.965	-16.5	2.37	164.1	0.00316	84.8	0.995	-8.1
250	0.963	-20.0	2.35	160.4	0.00358	76.3	0.994	-10.2
300	0.953	-23.7	2.32	156.8	0.00431	84.0	0.992	-12.2
350	0.947	-26.8	2.30	152.9	0.00503	79.0	0.990	-14.2
400	0.942	-29.6	2.28	148.6	0.00545	76.6	0.987	-16.2
450	0.929	-32.8	2.26	144.9	0.00630	80.3	0.984	-18.1
500	0.923	-35.4	2.21	141.2	0.00646	76.1	0.981	-20.2
550	0.912	-38.5	2.19	137.6	0.00693	73.7	0.977	-22.1
600	0.903	-41.2	2.15	134.2	0.00732	72.9	0.974	-24.1
650	0.886	-44.2	2.12	130.6	0.00729	74.6	0.971	-26.0
700	0.879	-46.8	2.08	127.4	0.00733	72.0	0.967	-27.8
750	0.873	-49.2	2.06	124.3	0.00762	74.5	0.962	-29.7
800	0.859	-52.4	2.03	120.8	0.00756	73.7	0.959	-31.7
850	0.846	-55.4	2.00	117.3	0.00772	75.5	0.955	-33.6
900	0.836	-58.0	1.96	114.3	0.00775	79.6	0.951	-35.5
950	0.827	-60.4	1.93	111.0	0.00801	81.7	0.946	-37.3
1000	0.815	-62.8	1.89	108.0	0.00704	81.0	0.942	-39.4

Package Dimensions

As of January, 2001

Unit: mm

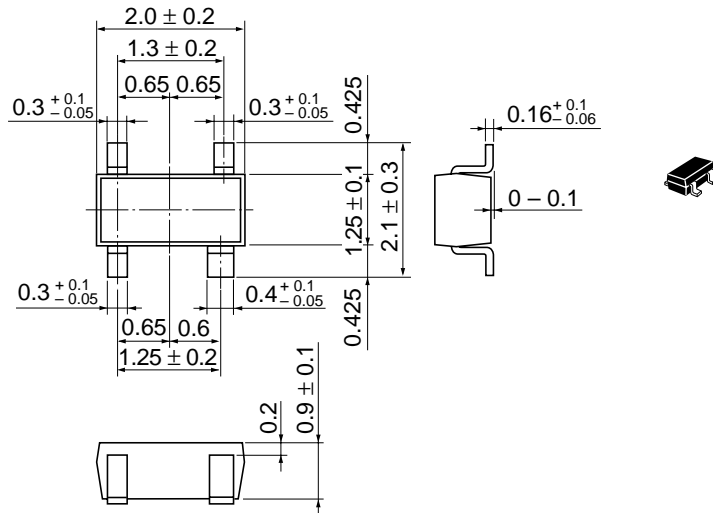

Hitachi Code	CMPAK-4(T)
JEDEC	—
EIAJ	Conforms
Mass (reference value)	0.006 g

Cautions

1. Hitachi neither warrants nor grants licenses of any rights of Hitachi's or any third party's patent, copyright, trademark, or other intellectual property rights for information contained in this document. Hitachi bears no responsibility for problems that may arise with third party's rights, including intellectual property rights, in connection with use of the information contained in this document.
2. Products and product specifications may be subject to change without notice. Confirm that you have received the latest product standards or specifications before final design, purchase or use.
3. Hitachi makes every attempt to ensure that its products are of high quality and reliability. However, contact Hitachi's sales office before using the product in an application that demands especially high quality and reliability or where its failure or malfunction may directly threaten human life or cause risk of bodily injury, such as aerospace, aeronautics, nuclear power, combustion control, transportation, traffic, safety equipment or medical equipment for life support.
4. Design your application so that the product is used within the ranges guaranteed by Hitachi particularly for maximum rating, operating supply voltage range, heat radiation characteristics, installation conditions and other characteristics. Hitachi bears no responsibility for failure or damage when used beyond the guaranteed ranges. Even within the guaranteed ranges, consider normally foreseeable failure rates or failure modes in semiconductor devices and employ systemic measures such as fail-safes, so that the equipment incorporating Hitachi product does not cause bodily injury, fire or other consequential damage due to operation of the Hitachi product.
5. This product is not designed to be radiation resistant.
6. No one is permitted to reproduce or duplicate, in any form, the whole or part of this document without written approval from Hitachi.
7. Contact Hitachi's sales office for any questions regarding this document or Hitachi semiconductor products.

HITACHI

Hitachi, Ltd.

Semiconductor & Integrated Circuits.
Nippon Bldg., 2-6-2, Ohte-machi, Chiyoda-ku, Tokyo 100-0004, Japan
Tel: Tokyo (03) 3270-2111 Fax: (03) 3270-5109

URL	NorthAmerica	: http://semiconductor.hitachi.com/
	Europe	: http://www.hitachi-eu.com/hel/ecg
	Asia	: http://sicapac.hitachi-asia.com
	Japan	: http://www.hitachi.co.jp/Sicd/indx.htm

For further information write to:

Hitachi Semiconductor
(America) Inc.
179 East Tasman Drive,
San Jose, CA 95134
Tel: <1> (408) 433-1990
Fax: <1> (408) 433-0223

Hitachi Europe GmbH
Electronic Components Group
Dornacher Straße 3
D-85622 Feldkirchen, Munich
Germany
Tel: <49> (89) 9 9180-0
Fax: <49> (89) 9 29 30 00

Hitachi Europe Ltd.
Electronic Components Group.
Whitebrook Park
Lower Cookham Road
Maidenhead
Berkshire SL6 8YA, United Kingdom
Tel: <44> (1628) 585000
Fax: <44> (1628) 585160

Hitachi Asia Ltd.
Hitachi Tower
16 Collyer Quay #20-00,
Singapore 049318
Tel: <65>-538-6533/538-8577
Fax: <65>-538-6933/538-3877
URL: <http://www.hitachi.com.sg>

Hitachi Asia Ltd.
(Taipei Branch Office)
4/F, No. 167, Tun Hwa North Road,
Hung-Kuo Building,
Taipei (105), Taiwan
Tel: <886>-(2)-2718-3666
Fax: <886>-(2)-2718-8180
Telex: 23222 HAS-TP
URL: <http://www.hitachi.com.tw>

Hitachi Asia (Hong Kong) Ltd.
Group III (Electronic Components)
7/F., North Tower,
World Finance Centre,
Harbour City, Canton Road
Tsim Sha Tsui, Kowloon,
Hong Kong
Tel: <852>-(2)-735-9218
Fax: <852>-(2)-730-0281
URL: <http://www.hitachi.com.hk>

Copyright © Hitachi, Ltd., 2000. All rights reserved. Printed in Japan.
Colophon 2.0