

High Speed Single Supply Quad Operational Amplifier

■ GENERAL DESCRIPTION

The **NJM2744** is a high-speed single supply quad operational amplifier. The low V_{OL} enables to treat small output signal on a single supply.

It has wide supply voltage range, +3V to +32V and high slew rate.

The **NJM2744** is suitable for power supply and motor driver units.

■ FEATURES

- Slew Rate 10V/ μ s typ.
- Capacitive Load Tolerance 1000pF typ.
- Output Voltage range 0.2V~3.7V at $V^+=+5V$, $R_L=2k\Omega$
- Operating Voltage 3V~32V
- Single Supply operation
- Bipolar Technology
- Package Outline DIP14, DMP14, SSOP14

■ APPLICATIONS

- Low side current sensing, Inverter motor control
- Power monitor module: UPS, PSU etc.
- Line driver, AD/DA buffer, FET driver

■ PIN CONFIGURATION

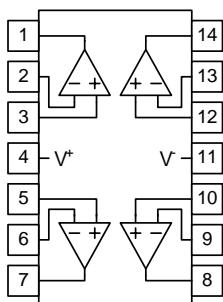

Pin Function

- | | |
|-------------|--------------|
| 1. A OUTPUT | 8. C OUTPUT |
| 2. A -INPUT | 9. C -INPUT |
| 3. A +INPUT | 10. C +INPUT |
| 4. V^+ | 11. V^- |
| 5. B +INPUT | 12. D +INPUT |
| 6. B -INPUT | 13. D -INPUT |
| 7. B OUTPUT | 14. D OUTPUT |

■ PACKAGR OUTLINE

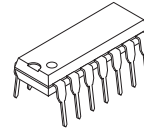

NJM2744D

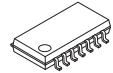

NJM2744M



NJM2744V

NJM2744

■ ABSOLUTE MAXIMUM RATINGS (Ta=25°C, unless otherwise noted.)

PARAMETER	SYMBOL	RATING	UNIT
Supply Voltage	V ⁺	+36	V
Common Mode Input Voltage Range	V _{ICM}	-0.3 ~ +36(Note1)	V
Differential Input Voltage Range	V _{ID}	±36(Note1)	V
Power Dissipation (Note3)	P _D	1400(DIP14) (Note2) 650(DMP14) (Note2) 560(SSOP14) (Note2)	mW
Operating Temperature Range	Topr	-40~+85	°C
Storage Temperature Range	Tstg	-50~+150	°C

(Note1) For supply voltage less than +36V, the absolute maximum input voltage is equal to supply voltage.

(Note2) On the PCB "EIA/JEDEC (76.2x114.3x1.6mm, 2 layers, FR-4)"

(Note3) See Figure.1 "Power Dissipation Derating Curve" when ambient temperature is over 25°C.

Figure.1 Power Dissipation Derating Curve

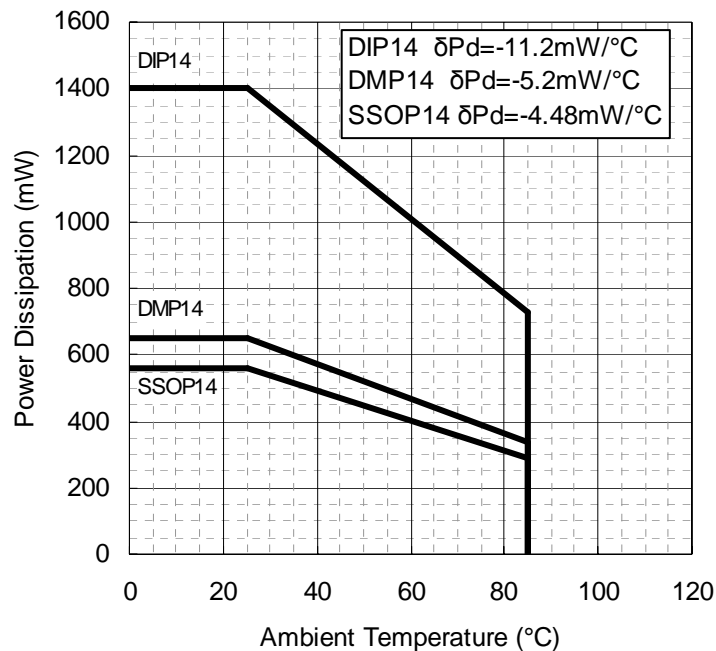

■ RECOMMENDED OPERATING CONDITION (Ta=25°C)

PARAMETER	SYMBOL	TEST CONDITION	MIN.	TYP.	MAX.	UNIT
Supply Voltage	V ⁺		3.0	-	32	V

■ ELECTRICAL CHARACTERISTICS

● DC CHARACTERISTICS ($V^+/V^- = \pm 15V$, $T_a = 25^\circ C$, unless otherwise noted.)

PARAMETER	SYMBOL	TEST CONDITION	MIN.	TYP.	MAX.	UNIT
Supply Current	I_{CC}	No Signal, $R_s = 50\Omega$	-	7.5	10	mA
Input Offset Voltage	V_{IO}	$R_s = 50\Omega$	-	2	12	mV
Input Bias Current	I_B	$R_s = 50\Omega$	-	80	400	nA
Input Offset Current	I_{IO}	$R_s = 50\Omega$	-	5	75	nA
Voltage Gain	A_V	$R_L \geq 2k\Omega$, $V_o = \pm 10V$	80	110	-	dB
Common Mode Rejection Ratio	CMR	$-15V \leq V_{ICM} \leq 12.5V$	55	75	-	dB
Supply Voltage Rejection Ratio	SVR	$3V \leq V^+ \leq 32V$	70	90	-	dB
Maximum Output Voltage1	V_{OM1}	$R_L \geq 10k\Omega$ to GND	13.7 -13.7	14 -14.8	-	V
Maximum Output Voltage2	V_{OM2}	$R_L \geq 2k\Omega$ to GND	13.5 -13.5	-	-	V
Source Output Current	I_{SOURCE}	$V_{IN+} = 1V$, $V_{IN-} = 0V$, $V_O = 0V$	10	30	-	mA
Sink Output Current	I_{SINK}	$V_{IN+} = 0V$, $V_{IN-} = 1V$, $V_O = 0V$	10	30	-	mA
Common Mode Input Voltage Range	V_{ICM}	CMR $\geq 55dB$	-15	-	12.5	V

● AC CHARACTERISTICS ($V^+/V^- = \pm 15V$, $T_a = 25^\circ C$, unless otherwise noted.)

PARAMETER	SYMBOL	TEST CONDITION	MIN.	TYP.	MAX.	UNIT
Gain Bandwidth Product	GB		-	2	-	MHz
Slew Rate	SR		-	10	-	V/ μs
Equivalent Input Noise Voltage	V_{NI}	$f = 1kHz$	-	40	-	nV/ \sqrt{Hz}
Capacitive Load Tolerance	C_L		-	1000	-	pF

■ ELECTRICAL CHARACTERISTICS

● DC CHARACTERISTICS ($V^+ = +5V$, $V^- = 0V$, $T_a = 25^\circ C$, unless otherwise noted.)

PARAMETER	SYMBOL	TEST CONDITION	MIN.	TYP.	MAX.	UNIT
Supply Current	I_{CC}	No Signal, $R_s = 50\Omega$	-	5.5	9	mA
Input Offset Voltage	V_{IO}	$R_s = 50\Omega$	-	2	12	mV
Input Bias Current	I_B	$R_s = 50\Omega$	-	80	400	nA
Input Offset Current	I_{IO}	$R_s = 50\Omega$	-	5	75	nA
Voltage Gain	A_V	$R_L = 2k\Omega$, $V_o = \pm 1V$	80	110	-	dB
Common Mode Rejection Ratio	CMR	$0V \leq V_{ICM} \leq 2.8V$	50	60	-	dB
Supply Voltage Rejection Ratio	SVR	$3V \leq V^+ \leq 32V$	70	90	-	dB
Maximum Output Voltage1	V_{OH}	$R_L = 2k\Omega$ to GND	3.7	4	-	V
Maximum Output Voltage2	V_{OL}	$R_L = 2k\Omega$ to GND	-	0.1	0.2	V
Source Output Current	I_{SOURCE}	$V_{IN+} = 1V$, $V_{IN-} = 0V$, $V_O = 2.5V$	10	30	-	mA
Sink Output Current	I_{SINK}	$V_{IN+} = 0V$, $V_{IN-} = 1V$, $V_O = 2.5V$	10	30	-	mA
Common Mode Input Voltage Range	V_{ICM}	CMR $\geq 50dB$	0	-	2.8	V

● AC CHARACTERISTICS ($V^+ = +5V$, $V^- = 0V$, $T_a = 25^\circ C$, unless otherwise noted.)

PARAMETER	SYMBOL	TEST CONDITION	MIN.	TYP.	MAX.	UNIT
Gain Bandwidth Product	GB		-	2	-	MHz
Slew Rate	SR		-	7	-	V/ μs
Equivalent Input Noise Voltage	V_{NI}	$f = 1kHz$	-	40	-	nV/ \sqrt{Hz}
Capacitive Load Tolerance	C_L		-	1000	-	pF

Note: The common mode input voltage range of NJM2744 is shifted toward the V^- for single supply use.

At the low operating voltage, the center potential of the V^+ and V^- may be out of the common mode voltage range.

In this case, shift the common mode input voltage toward the V^- .

■ TYPICAL CHARACTERISTICS

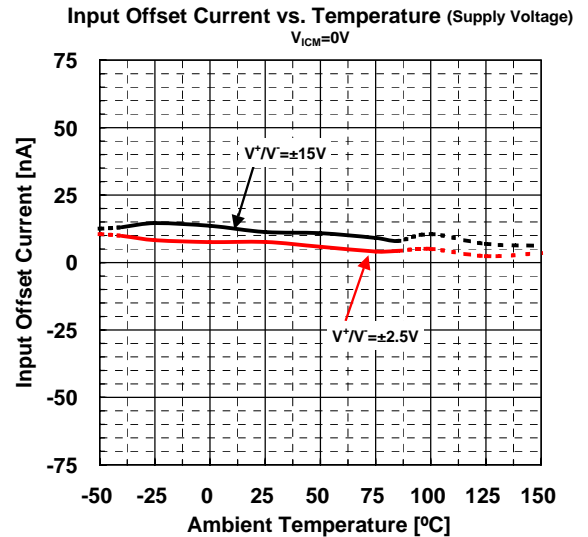
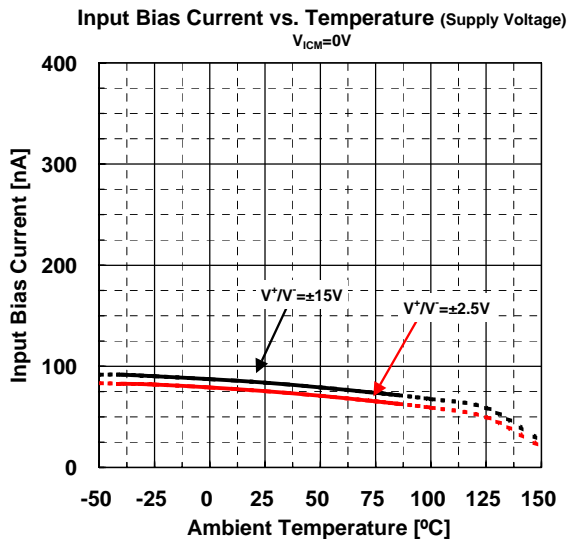
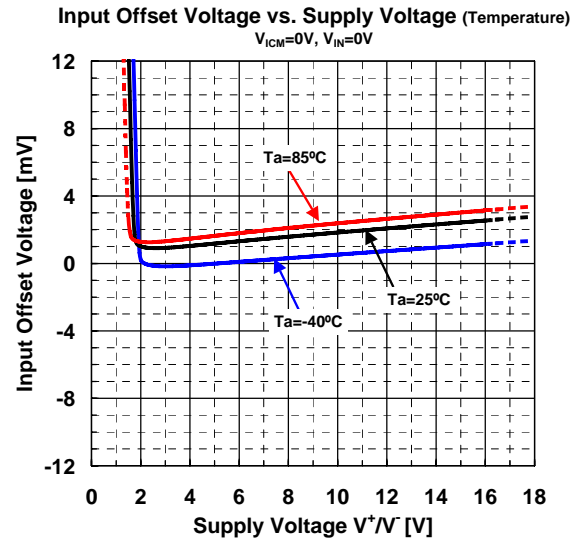
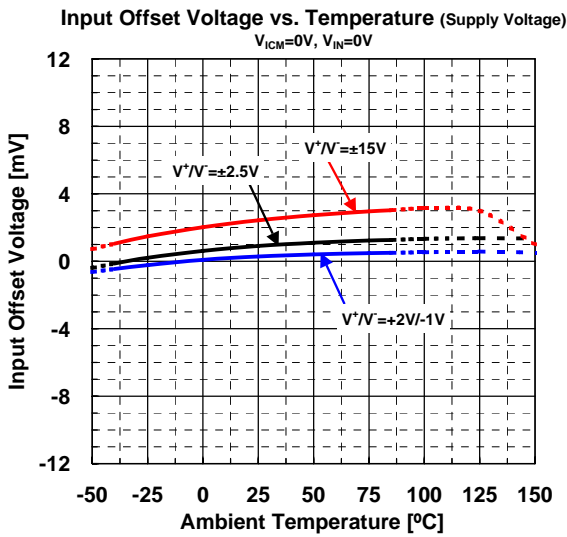
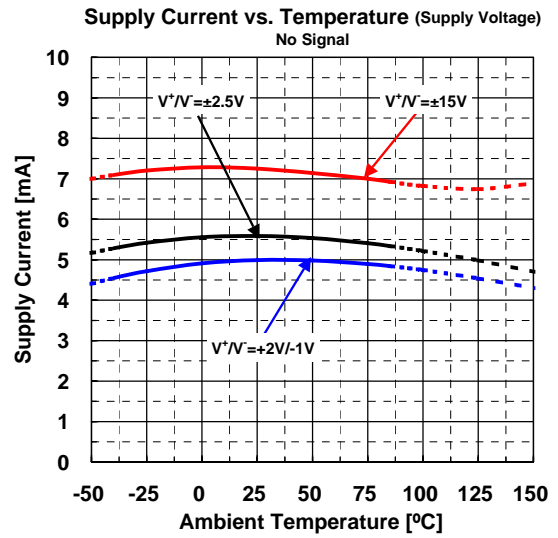
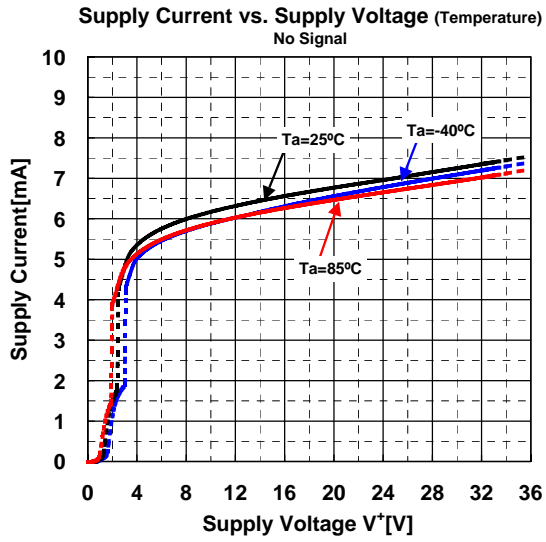

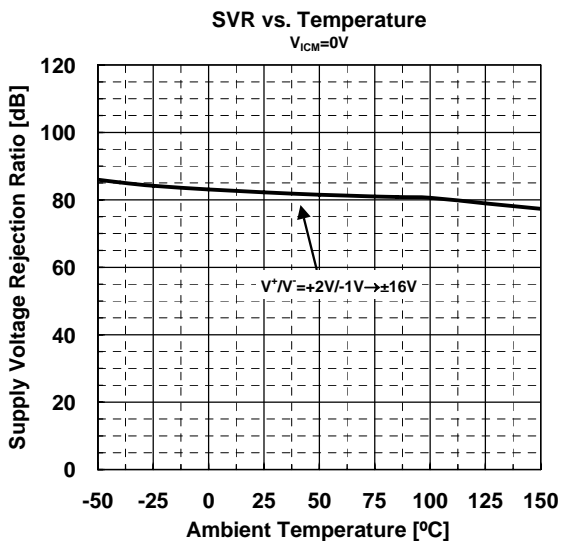
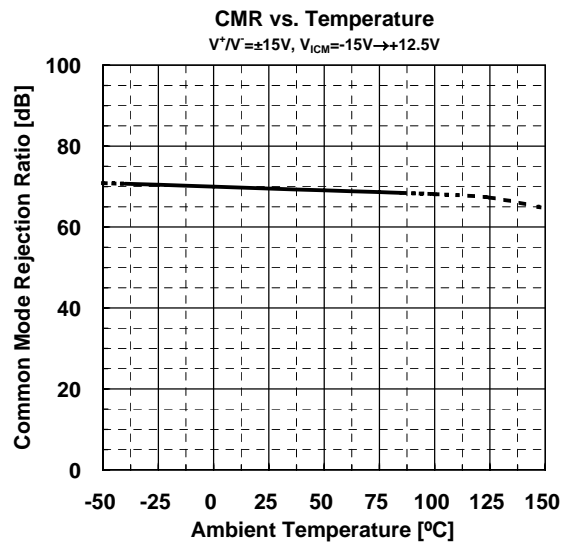
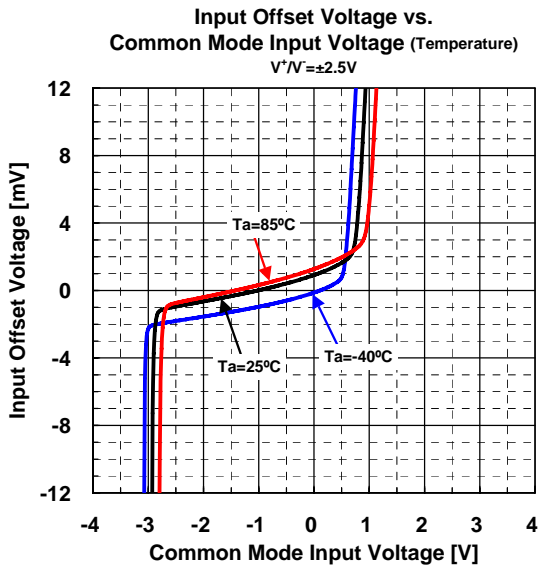
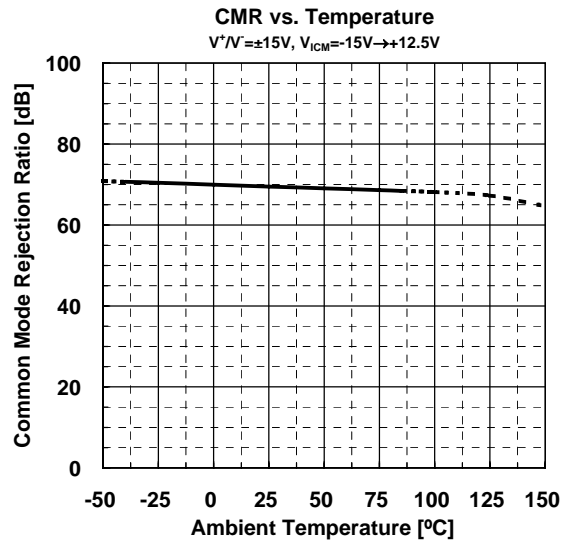
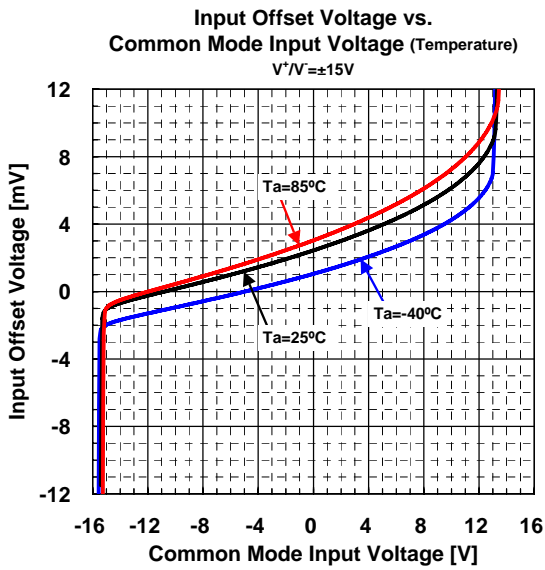

Gain vs. Temperature
 $V^+V^- = \pm 15V$, $R_L = 2k\Omega$ to $0V$,
 $C_L = 100p$ to $0V$, $V_O = -10V \rightarrow +10V$

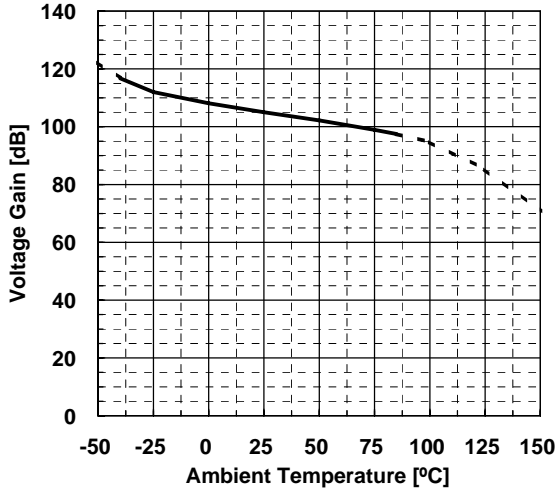

Gain vs. Temperature
 $V^+V^- = \pm 2.5V$, $R_L = 2k\Omega$ to $0V$,
 $C_L = 100p$ to $0V$, $V_O = -1V \rightarrow +1V$

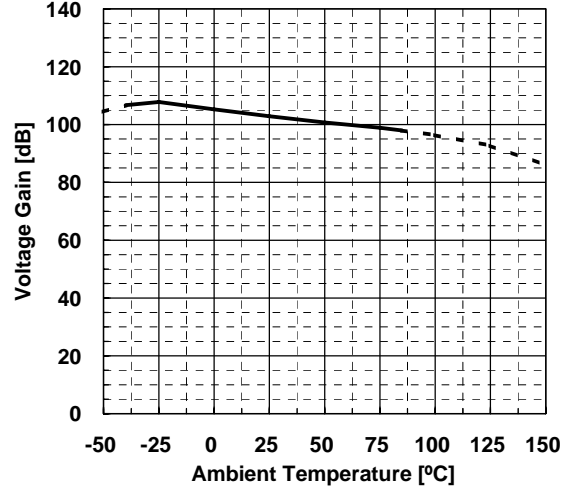

Maximum Output Voltage vs. Load Resistance (Temperature)
 $V^+V^- = \pm 15V$, $G_v = \text{open}$, R_L to $0V$

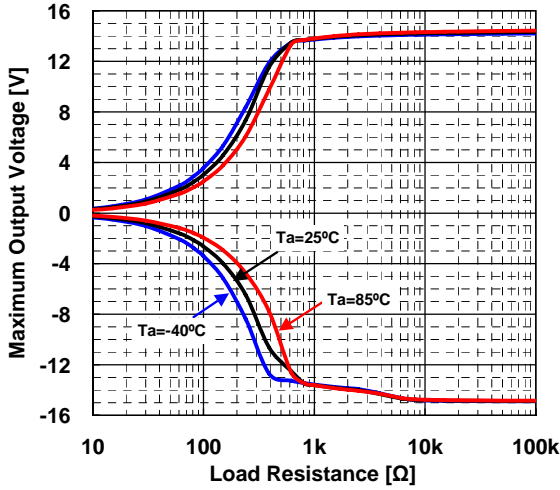

Maximum Output Voltage vs. Load Resistance (Temperature)
 $V^+ = +5V$, R_L to $0V$, $G_v = \text{open}$

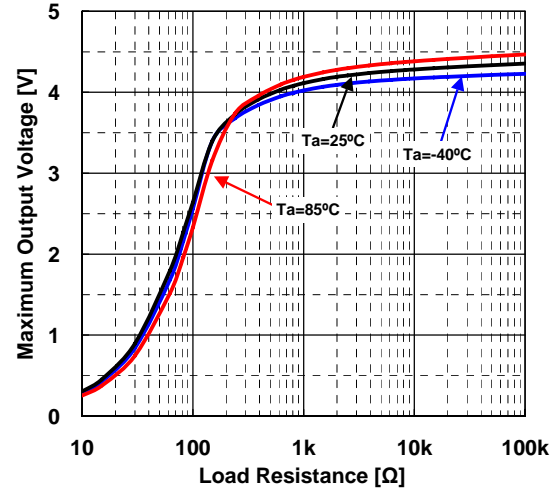

Maximum Output Voltage vs. Supply Voltage (Temperature)
 $R_L = 2k$ to $0V$

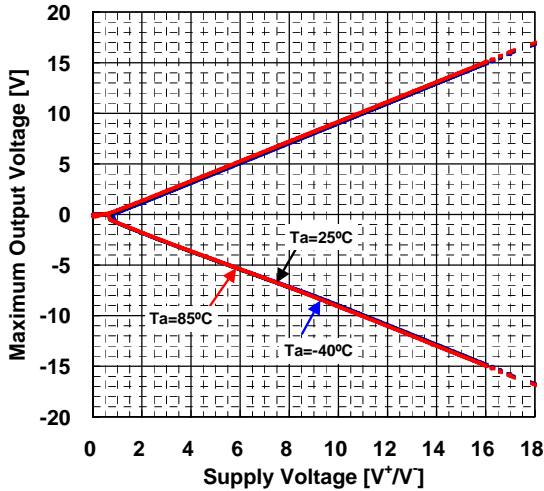

Maximum Output Voltage vs. Supply Voltage (Temperature)
 $R_L = 2k$ to $0V$

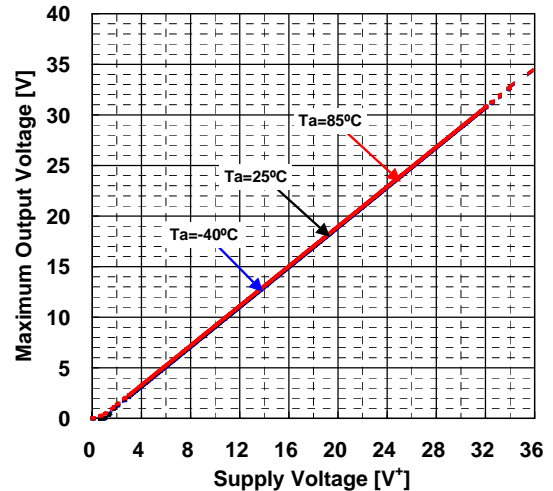

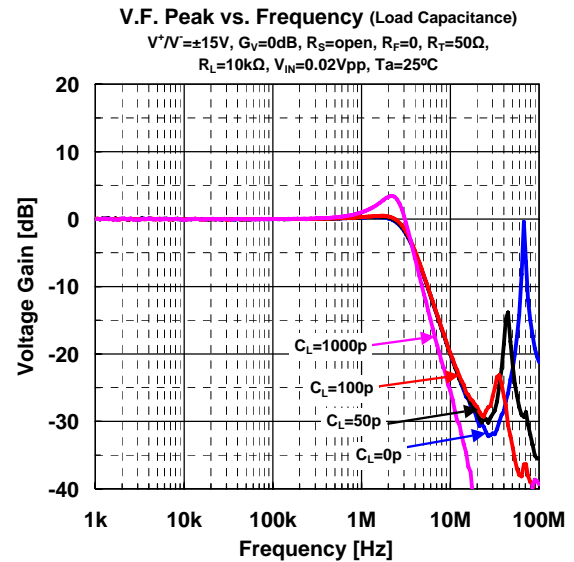
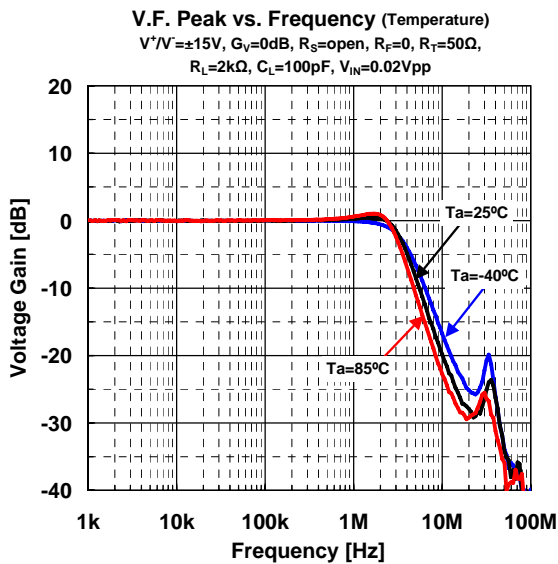
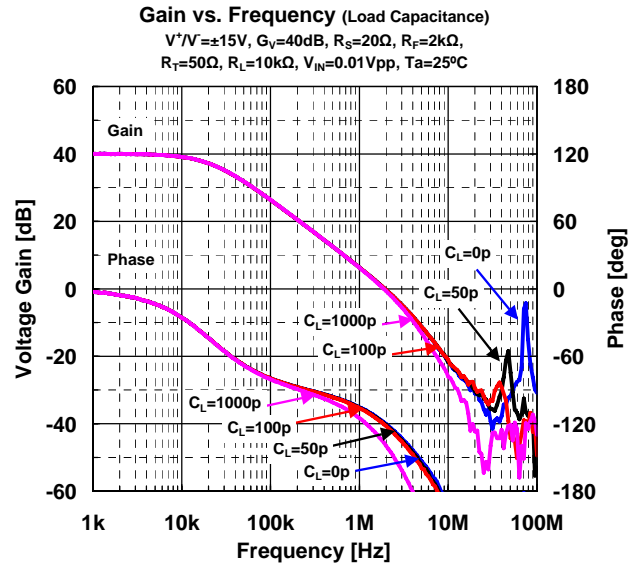
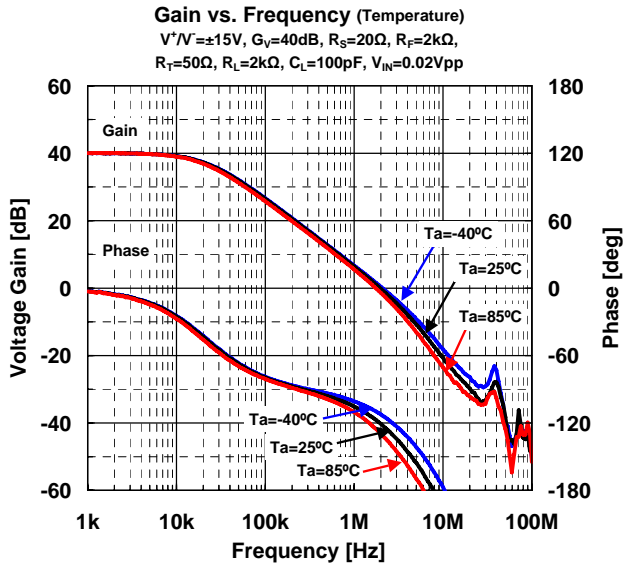
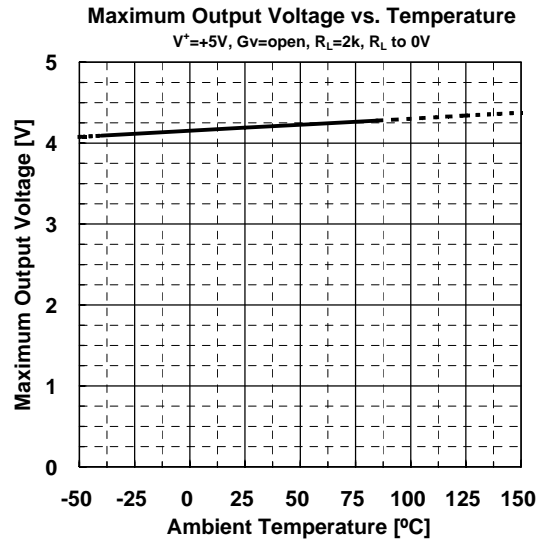
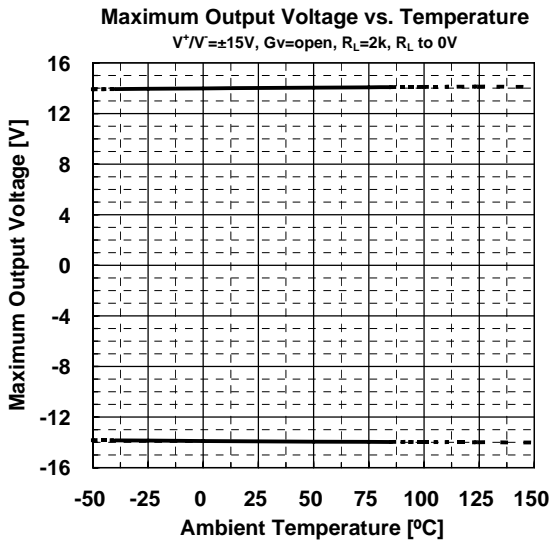

Pulse Response (Temperature)

$V^*V = \pm 15V$, $f = 250kHz$, $V_{IN} = 4V_{p,p}$, $Gv = 0dB$,
 $R_T = 50\Omega$, $R_F = 0\Omega$, $R_G = open$, $C_L = 100pF$, $R_L = 10k\Omega$

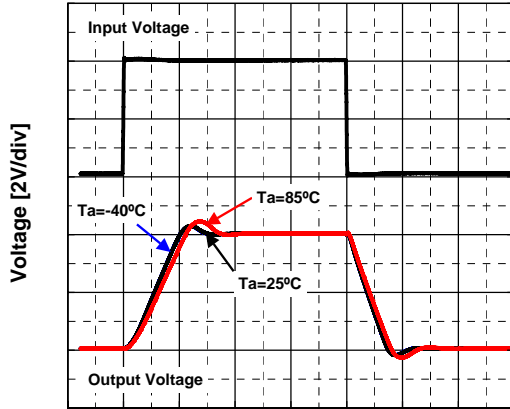

Time[0.5μsec/div]

Pulse Response (Load Capacitance)

$V^*V = \pm 15V$, $f = 250kHz$, $V_{IN} = 4V_{p,p}$, $Gv = 0dB$,
 $R_T = 50\Omega$, $R_F = 0\Omega$, $R_G = open$, $R_L = 10k\Omega$, $Ta = 25^\circ C$

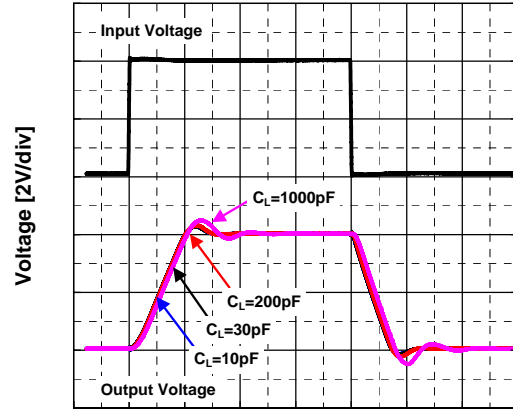

Time[0.5μsec/div]

Pulse Response (Load Resistance)

$V^*V = \pm 15V$, $f = 250kHz$, $V_{IN} = 4V_{p,p}$, $Gv = 0dB$,
 $R_T = 50\Omega$, $R_F = 0\Omega$, $R_G = open$, $C_L = 100pF$, $Ta = 25^\circ C$

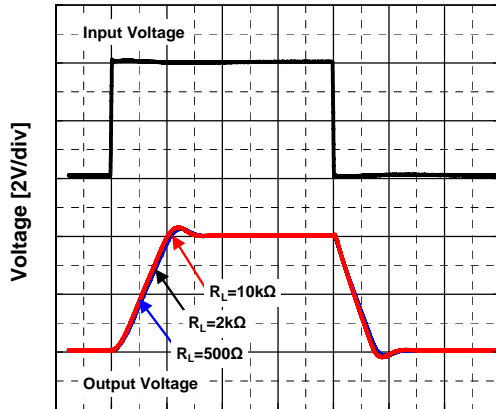

Time[0.5μsec/div]

■NOTE

[CAUTION]

The specifications on this databook are only given for information, without any guarantee as regards either mistakes or omissions. The application circuits in this databook are described only to show representative usages of the product and not intended for the guarantee or permission of any right including the industrial rights.