

Chip tantalum capacitors (Bottom surface electrode type)

TCT Series CL Case

●Features (CL)

- 1) Vital for all hybrid integrated circuits board application.
- 2) Wide capacitance range.
- 3) Screening by thermal shock.

●Dimensions (Unit : mm)

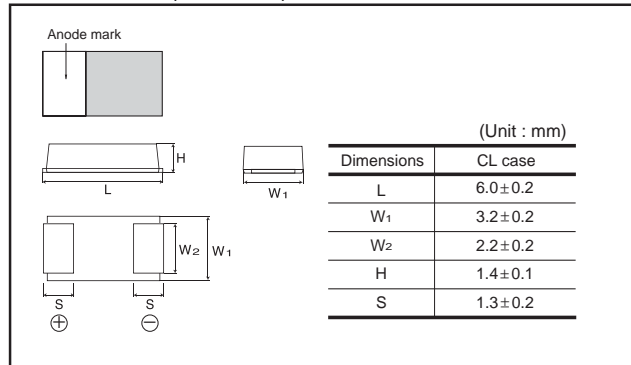

●Part No. Explanation

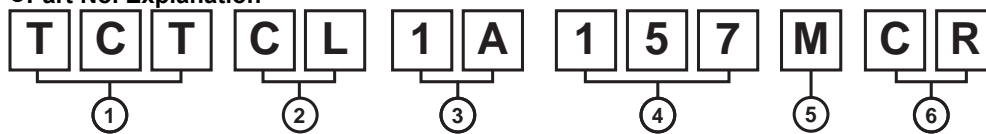

① Series name
TCT

② Case style
TC.....CL

③ Rated voltage

Rated voltage (V)	2.5	4	6.3	10	16
CODE	0E	0G	0J	1A	1C

④ Nominal capacitance
Nominal capacitance in pF in 3 digits:
2 significant figures followed by the figure
representing the number of 0's.

⑤ Capacitance tolerance
M : ±20%

⑥ Taping
C : Reel width : 12mm
R : Positive electrode on the side opposite to sprocket hole

● Rated table

(μF)	Rated voltage (V)				
	2.5 0E	4 0G	6.3 0J	10 1A	16 1C
10 (106)					
100 (107)					* CL
150 (157)				* CL	
220(227)			* CL		
330(337)		* CL			
470(477)	* CL				

Remark) Case size codes (CL) in the above show products line-up.
* Under development

● **Marking**

The indications listed below should be given on the surface of a capacitor.

- (1) Polarity
- (2) Rated DC voltage
- (3) Visual typical example (1) capacitance code (2) voltage code

[CL case] note 1) $\frac{10V}{(1)}$ $\frac{150}{(2)}$

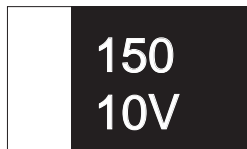

note 2) voltage code and capacitance code are variable with parts number

● **Characteristics**

Item		Performance	Test conditions (based on JIS C 5101-1 and JIS C 5101-3)															
Operating Temperature		-55°C to +125°C	Voltage reduction when temperature exceeds +85°C															
Maximum operating temperature with no voltage derating		+85°C																
Rated voltage (VDC)		2.5 4 6.3 10 16	at 85°C															
Category voltage (VDC)		1.6 2.5 4 6.3 10	at 125°C															
Surge voltage (VDC)		3.2 5.0 8 13 20	at 85°C															
DC Leakage current		Shall be satisfied the voltage on " Standard list "	As per 4.9 JIS C 5101-1 As per 4.5.1 JIS C 5101-3 Voltage : Rated voltage for 5min															
Capacitance tolerance		Shall be satisfied allowance range. ±20%	As per 4.7 JIS C 5101-1 As per 4.5.2 JIS C 5101-3 Measuring frequency : 120±12Hz Measuring voltage : 0.5Vrms +1.5 to 2V.DC Measuring circuit : DC Equivalent series circuit															
Tangent of loss angle (Df, tan δ)		Shall be satisfied the voltage on " Standard list "	As per 4.8 JIS C 5101-1 As per 4.5.3 JIS C 5101-3 Measuring frequency : 120±12Hz Measuring voltage : 0.5Vrms +1.5 to 2V.DC Measuring circuit : DC Equivalent series circuit															
Impedance		Shall be satisfied the voltage on " Standard list "	As per 4.10 JIS C 5101-1 As per 4.5.4 JIS C 5101-3 Measuring frequency : 100±10kHz Measuring voltage : 0.5Vrms or less Measuring circuit : DC Equivalent series circuit															
Resistance to Soldering heat	Appearance	There should be no significant abnormality. The indications should be clear.	As per 4.14 JIS C 5101-1 As per 4.6 JIS C 5101-3 Dip in the solder bath Solder temp : 260±5°C Duration : 5±0.5s Repetition : 1 After the specimens, leave it at room temperature for over 24h and then measure the sample.															
	L.C.	Less than 200% of initial limit																
	ΔC / C	Within ±20% of initial value																
	Df (tan δ)	Less than 200% of initial limit																
Temperature cycle	Appearance	There should be no significant abnormality. The indications should be clear.	As per 4.16 JIS C 5101-1 As per 4.10 JIS C 5101-3 Repetition : 5 cycles (1 cycle : steps 1 to 4) without discontinuation.															
	L.C.	Less than 200% of initial limit																
	ΔC / C	Within ±20% of initial value																
	Df (tan δ)	Less than 200% of initial limit																
			<table border="1"> <thead> <tr> <th></th> <th>Temp.</th> <th>Time</th> </tr> </thead> <tbody> <tr> <td>1</td> <td>-55±3°C</td> <td>30±3min.</td> </tr> <tr> <td>2</td> <td>Room temp.</td> <td>3min. or less</td> </tr> <tr> <td>3</td> <td>125±2°C</td> <td>30±3min.</td> </tr> <tr> <td>4</td> <td>Room temp.</td> <td>3min. or less</td> </tr> </tbody> </table>		Temp.	Time	1	-55±3°C	30±3min.	2	Room temp.	3min. or less	3	125±2°C	30±3min.	4	Room temp.	3min. or less
	Temp.	Time																
1	-55±3°C	30±3min.																
2	Room temp.	3min. or less																
3	125±2°C	30±3min.																
4	Room temp.	3min. or less																
			After the specimens, leave it at room temperature for over 24h and then measure the sample.															
Moisture resistance	Appearance	There should be no significant abnormality. The indications should be clear.	As per 4.22 JIS C 5101-1 As per 4.12 JIS C 5101-3 After leaving the sample under such atmospheric condition that the temperature and humidity are 60±2°C and 90 to 95% RH, respectively, for 500±12h leave it at room temperature for over 24h and then measure the sample.															
	L.C.	Less than 200% of initial limit																
	ΔC / C	Within ±20% of initial value																
	Df (tan δ)	Less than 200% of initial limit																

Item		Performance	Test conditions (based on JIS C 5101-1 and JIS C 5101-3)
Temperature Stability	Temp.	-55°C	As per 4.29 JIS C 5101-1 As per 4.13 JIS C 5101-3
	ΔC / C	Within 0/-15% of initial value	
	Df (tan δ)	Shall be satisfied the voltage on " Standard list "	
	L.C.	-	
	Temp.	+85°C	
	ΔC / C	Within +15/-5% of initial value	
	Df (tan δ)	Shall be satisfied the voltage on " Standard list "	
	L.C.	Less than 1000% of initial limit	
	Temp.	+125°C	
	ΔC / C	Within +20/-5% of initial value	
	Df (tan δ)	Shall be satisfied the voltage on " Standard list "	
L.C.	Less than 1250% of initial limit		
Surge voltage	Appearance	There should be no significant abnormality.	As per 4.26 JIS C 5101-1 As per 4.14 JIS C 5101-3 Apply the specified surge voltage via the serial resistance of 1kΩ every 5±0.5 min. for 30±5 s. each time in the atmospheric condition of 85±2°C. Repeat this procedure 1,000 times. After the specimens, leave it at room temperature for over 24h and then measure the sample.
	L.C.	Less than 200% of initial limit	
	ΔC / C	Within ±20% of initial value	
	Df (tan δ)	Less than 200% of initial limit	
Loading at High temperature	Appearance	There should be no significant abnormality.	As per 4.23 JIS C 5101-1 As per 4.15 JIS C 5101-3 After applying the rated voltage for 1000+36/0 h without discontinuation via the serial resistance of 3Ω or less at a temperature of 85±2°C, leave the sample at room temperature / humidity for over 24h and measure the value.
	L.C.	Less than 200% of initial limit	
	ΔC / C	Within ±20% of initial value	
	Df (tan δ)	Less than 200% of initial limit	
Terminal strength	Capacitance	The measured value should be stable.	As per 4.35 JIS C 5101-1 As per 4.9 JIS C 5101-3 A force is applied to the terminal until it bends to 1mm and by a prescribed tool maintain the condition for 5s. (See the figure below)
	Appearance	There should be no significant abnormality.	

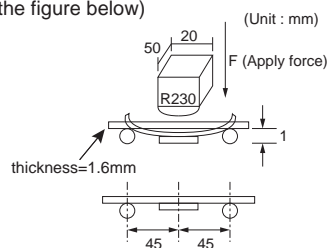

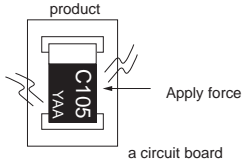
Item		Performance	Test conditions (JIS C 5101-1 and JIS C 5101-3)
Adhesiveness		The terminal should not come off.	As per 4.34 JIS C 5101-1 As per 4.8 JIS C 5101-3 Apply force of 5N in the two directions shown in the figure below for 10±1s after mounting the terminal on a circuit board. 
Dimensions		Refer to "External dimensions"	Measure using a caliper of JIS B 7507 Class 2 or higher grade.
Resistance to solvents		The indication should be clear	As per 4.32 JIS C 5101-1 As per 4.18 JIS C 5101-3 Dip in the isopropyl alcohol for 30±5s, at room temperature.
Solderability		3/4 or more surface area of the solder coated terminal dipped in the soldering bath should be covered with the new solder.	As per 4.15.2 JIS C 5101-1 As per 4.7 JIS C 5101-3 Dip speed=25±2.5mm / s Pre-treatment(accelerated aging): Leave the sample on the boiling distilled water for 1 h. Solder temp. : 245±5°C Duration : 3±0.5s Solder : M705 Flux : Rosin 25% IPA 75%
Vibration	Capacitance	Measure value should not fluctuate during the measurement.	As per 4.17 JIS C 5101-1 Frequency : 10 to 55 to 10Hz/min. Amplitude : 1.5mm Time : 2h each in X and Y directions Mounting : The terminal is soldered on a print circuit board.
	Appearance	There should be no significant abnormality.	

● Standard products list, TCT series CL case

Part No.	Rated voltage 85°C (V)	Category voltage 125°C (V)	Surge voltage 85°C (V)	Cap. 120Hz (μF)	Tolerance (%)	Leakage current 25°C 1WV.60s (μA)	Df 120Hz (%)			Impedance 100kHz (Ω)
							-55°C	25°C 85°C	125°C	
*TCT CL 0E 477M8R	2.5	1.6	3.2	470	±20	11.8	36	18	28	0.5
*TCT CL 0G 337M8R	4	2.5	5	330	±20	13.2	34	16	24	0.7
*TCT CL 0J 227M8R	6.3	4	8	220	±20	13.9	32	14	20	0.8
*TCT CL 1A 157M8R	10	6.3	13	150	±20	15.0	30	12	16	1.3
*TCT CL 1C 107M8R	16	10	20	100	±20	16.0	28	10	14	1.6

*= Under development

● Packaging specifications

Case code	A±0.1	B±0.1	t1±0.05	t2±0.1
CL	3.5	6.6	0.3	1.7

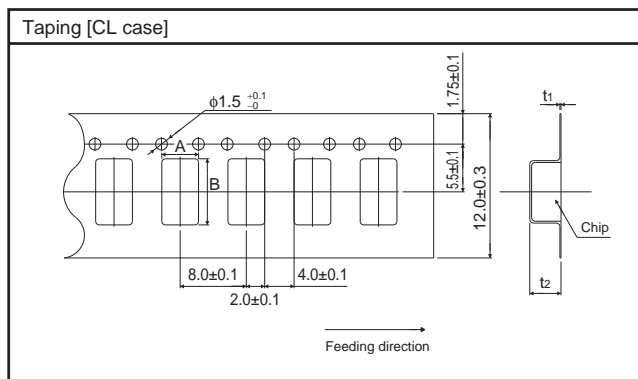

● Packaging style

Case code	Packaging	Packaging style		Symbol	Basic ordering units
CL case	Taping	plastic taping	φ180mm Reel	R	1,000pcs

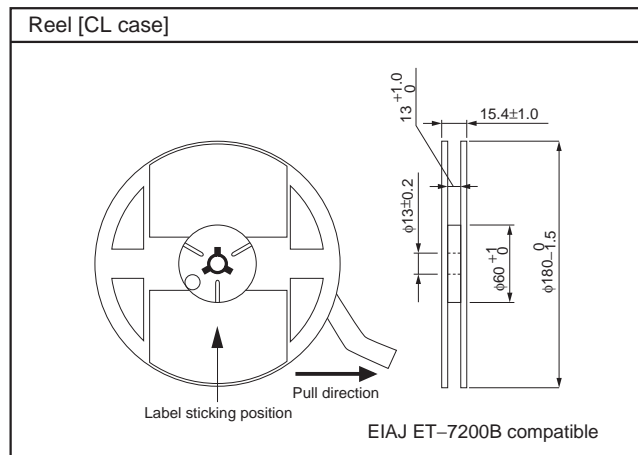

● Damp proof package

- ① One reel is packed in aluminum bag.
The size of aluminum bag is 240(a) x 250(b)mm.
The size up to 230(c)mm is to zipper.
- ② A desiccant is packed with a reel.
- ③ The aluminum bag is heat-sealed.
- ④ The label of the same as the label on the reel is placed on the aluminum bag.

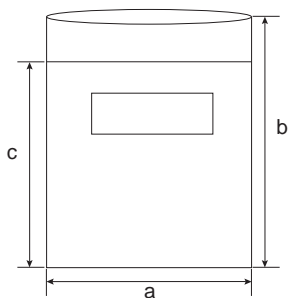

Notes

No copying or reproduction of this document, in part or in whole, is permitted without the consent of ROHM Co.,Ltd.

The content specified herein is subject to change for improvement without notice.

The content specified herein is for the purpose of introducing ROHM's products (hereinafter "Products"). If you wish to use any such Product, please be sure to refer to the specifications, which can be obtained from ROHM upon request.

Examples of application circuits, circuit constants and any other information contained herein illustrate the standard usage and operations of the Products. The peripheral conditions must be taken into account when designing circuits for mass production.

Great care was taken in ensuring the accuracy of the information specified in this document. However, should you incur any damage arising from any inaccuracy or misprint of such information, ROHM shall bear no responsibility for such damage.

The technical information specified herein is intended only to show the typical functions of and examples of application circuits for the Products. ROHM does not grant you, explicitly or implicitly, any license to use or exercise intellectual property or other rights held by ROHM and other parties. ROHM shall bear no responsibility whatsoever for any dispute arising from the use of such technical information.

The Products specified in this document are intended to be used with general-use electronic equipment or devices (such as audio visual equipment, office-automation equipment, communication devices, electronic appliances and amusement devices).

The Products specified in this document are not designed to be radiation tolerant.

While ROHM always makes efforts to enhance the quality and reliability of its Products, a Product may fail or malfunction for a variety of reasons.

Please be sure to implement in your equipment using the Products safety measures to guard against the possibility of physical injury, fire or any other damage caused in the event of the failure of any Product, such as derating, redundancy, fire control and fail-safe designs. ROHM shall bear no responsibility whatsoever for your use of any Product outside of the prescribed scope or not in accordance with the instruction manual.

The Products are not designed or manufactured to be used with any equipment, device or system which requires an extremely high level of reliability the failure or malfunction of which may result in a direct threat to human life or create a risk of human injury (such as a medical instrument, transportation equipment, aerospace machinery, nuclear-reactor controller, fuel-controller or other safety device). ROHM shall bear no responsibility in any way for use of any of the Products for the above special purposes. If a Product is intended to be used for any such special purpose, please contact a ROHM sales representative before purchasing.

If you intend to export or ship overseas any Product or technology specified herein that may be controlled under the Foreign Exchange and the Foreign Trade Law, you will be required to obtain a license or permit under the Law.



Thank you for your accessing to ROHM product informations.
More detail product informations and catalogs are available, please contact us.

ROHM Customer Support System

<http://www.rohm.com/contact/>