

- 1 - Anode 1
- 2 - Common Cathode
Back of Case - Cathode
- 3 - Anode 2

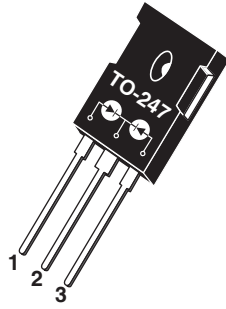

APT40DQ60BCT 600V 2X40A

ULTRAFAST SOFT RECOVERY RECTIFIER DIODE

PRODUCT APPLICATIONS	PRODUCT FEATURES	PRODUCT BENEFITS
<ul style="list-style-type: none"> • Anti-Parallel Diode <ul style="list-style-type: none"> -Switchmode Power Supply -Inverters • Free Wheeling Diode <ul style="list-style-type: none"> -Motor Controllers -Converters • Snubber Diode • Uninterruptible Power Supply (UPS) • Induction Heating • High Speed Rectifiers 	<ul style="list-style-type: none"> • Ultrafast Recovery Times • Soft Recovery Characteristics • Popular TO-247 Package • Low Forward Voltage • High Blocking Voltage • Low Leakage Current 	<ul style="list-style-type: none"> • Low Losses • Low Noise Switching • Cooler Operation • Higher Reliability Systems • Increased System Power Density

MAXIMUM RATINGS

All Ratings Per Leg: $T_C = 25^\circ\text{C}$ unless otherwise specified.

Symbol	Characteristic / Test Conditions	APT40DQ60BCT	UNIT
V_R	Maximum D.C. Reverse Voltage	600	Volts
V_{RRM}	Maximum Peak Repetitive Reverse Voltage		
V_{RWM}	Maximum Working Peak Reverse Voltage		
$I_{F(AV)}$	Maximum Average Forward Current ($T_C = 111^\circ\text{C}$, Duty Cycle = 0.5)	40	Amps
$I_{F(AV)}$	RMS Forward Current (Square wave, 50% duty)	63	
I_{FSM}	Non-Repetitive Forward Surge Current ($T_J = 45^\circ\text{C}$, 8.3ms)	320	
T_J, T_{STG}	Operating and Storage Temperature Range	-55 to 175	$^\circ\text{C}$
T_L	Lead Temperature for 10 Sec.	300	

STATIC ELECTRICAL CHARACTERISTICS

Symbol	Characteristic / Test Conditions	MIN	TYP	MAX	UNIT	
V_F	Forward Voltage		$I_F = 40\text{A}$	2.0	2.4	Volts
			$I_F = 80\text{A}$	2.5		
			$I_F = 40\text{A}, T_J = 125^\circ\text{C}$	1.7		
I_{RM}	Maximum Reverse Leakage Current		$V_R = V_R$ Rated		250	μA
			$V_R = V_R$ Rated, $T_J = 125^\circ\text{C}$		500	
C_T	Junction Capacitance, $V_R = 200\text{V}$		36		pF	

DYNAMIC CHARACTERISTICS

APT40DQ60BCT

Symbol	Characteristic	Test Conditions	MIN	TYP	MAX	UNIT
t_{rr}	Reverse Recovery Time	$I_F = 1A, di_F/dt = -100A/\mu s, V_R = 30V, T_J = 25^\circ C$	-	22		ns
t_{rr}	Reverse Recovery Time	$I_F = 40A, di_F/dt = -200A/\mu s, V_R = 400V, T_C = 25^\circ C$	-	25		
Q_{rr}	Reverse Recovery Charge		-	35		nC
I_{RRM}	Maximum Reverse Recovery Current		-	3	-	Amps
t_{rr}	Reverse Recovery Time	$I_F = 40A, di_F/dt = -200A/\mu s, V_R = 400V, T_C = 125^\circ C$	-	160		ns
Q_{rr}	Reverse Recovery Charge		-	480		nC
I_{RRM}	Maximum Reverse Recovery Current		-	6	-	Amps
t_{rr}	Reverse Recovery Time	$I_F = 40A, di_F/dt = -1000A/\mu s, V_R = 400V, T_C = 125^\circ C$	-	85		ns
Q_{rr}	Reverse Recovery Charge		-	920		nC
I_{RRM}	Maximum Reverse Recovery Current		-	20		Amps

THERMAL AND MECHANICAL CHARACTERISTICS

Symbol	Characteristic / Test Conditions	MIN	TYP	MAX	UNIT
$R_{\theta JC}$	Junction-to-Case Thermal Resistance			.67	$^\circ C/W$
$R_{\theta JA}$	Junction-to-Ambient Thermal Resistance			40	
W_T	Package Weight		0.22		oz
			5.9		g
Torque	Maximum Mounting Torque			10	lb•in
				1.1	N•m

APT Reserves the right to change, without notice, the specifications and information contained herein.

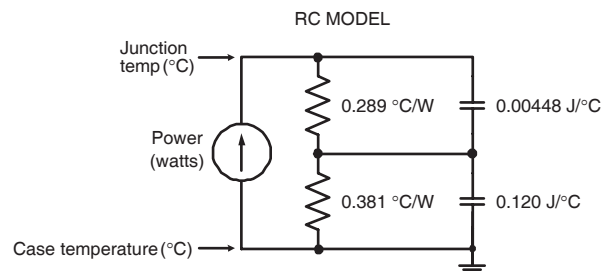
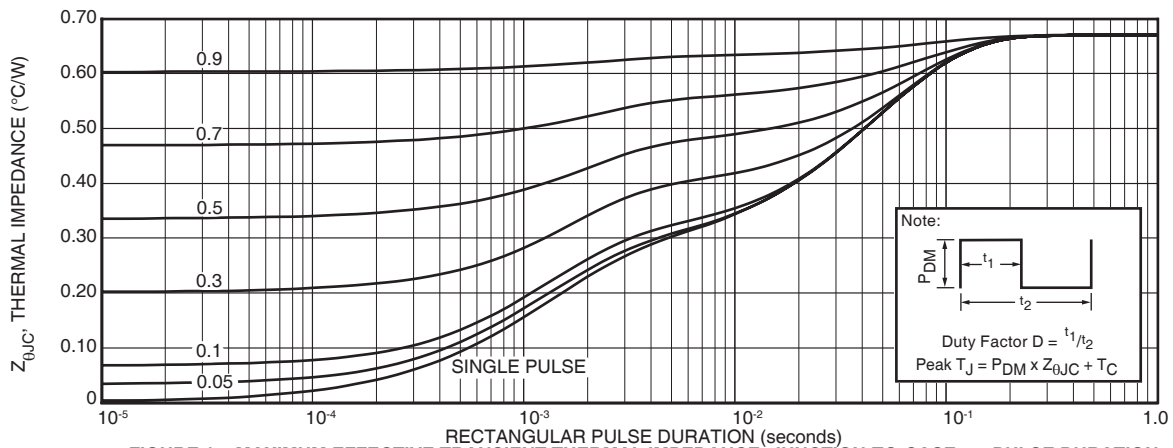

TYPICAL PERFORMANCE CURVES

APT40DQ60BCT

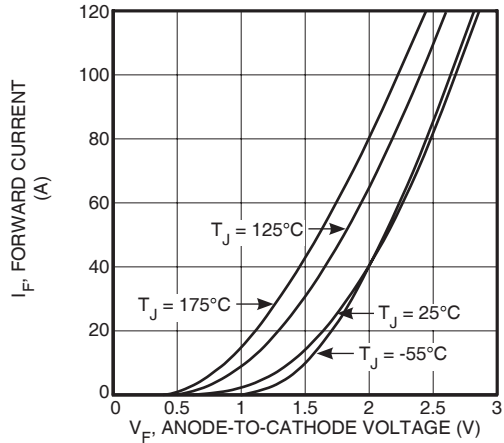

Figure 2. Forward Current vs. Forward Voltage

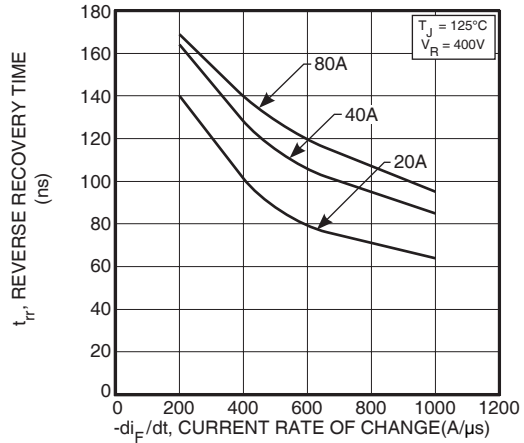

Figure 3. Reverse Recovery Time vs. Current Rate of Change

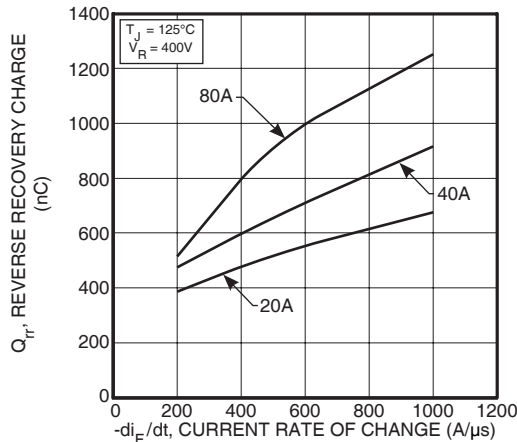

Figure 4. Reverse Recovery Charge vs. Current Rate of Change

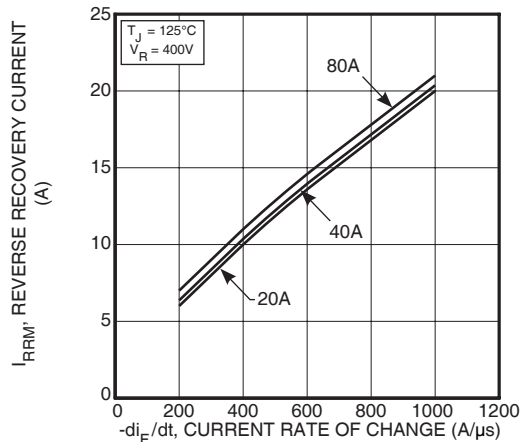

Figure 5. Reverse Recovery Current vs. Current Rate of Change

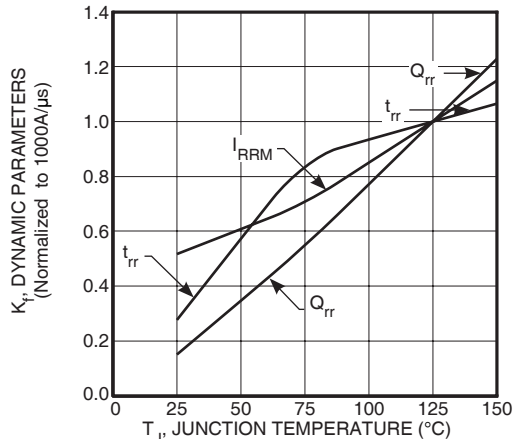

Figure 6. Dynamic Parameters vs. Junction Temperature

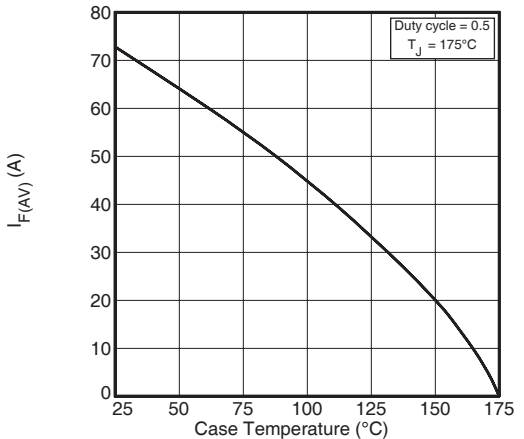

Figure 7. Maximum Average Forward Current vs. Case Temperature

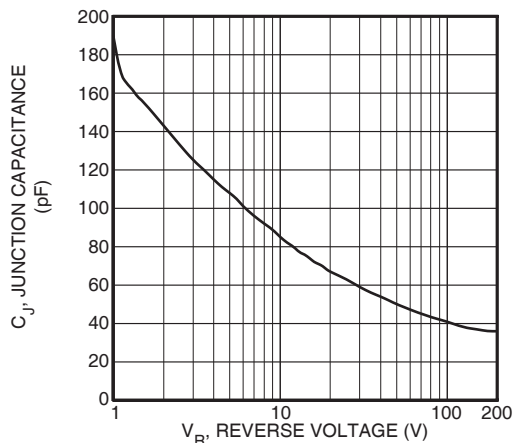

Figure 8. Junction Capacitance vs. Reverse Voltage

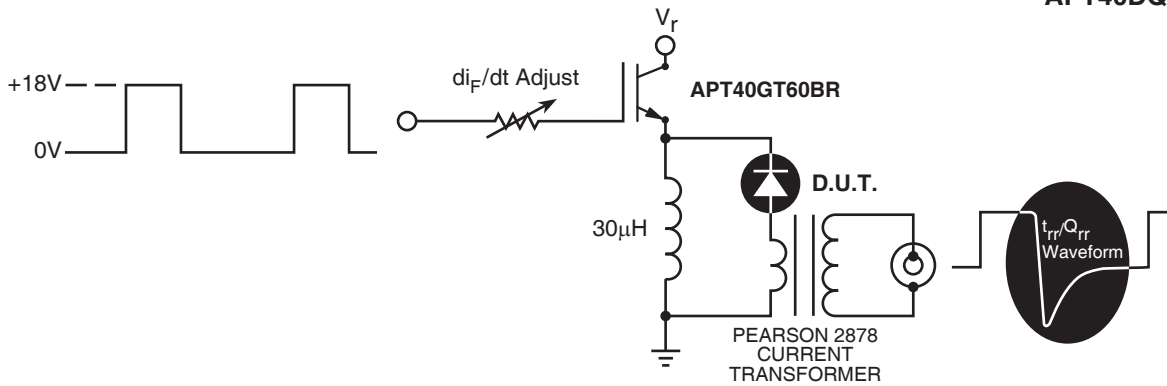

Figure 9. Diode Test Circuit

- 1 I_F - Forward Conduction Current
- 2 di_F/dt - Rate of Diode Current Change Through Zero Crossing.
- 3 I_{RRM} - Maximum Reverse Recovery Current.
- 4 t_{rr} - Reverse Recovery Time, measured from zero crossing where diode current goes from positive to negative, to the point at which the straight line through I_{RRM} and $0.25 \cdot I_{RRM}$ passes through zero.
- 5 Q_{rr} - Area Under the Curve Defined by I_{RRM} and t_{rr} .
- 6 di_M/dt - Maximum Rate of Current Increase During the Trailing Portion of t_{rr} .

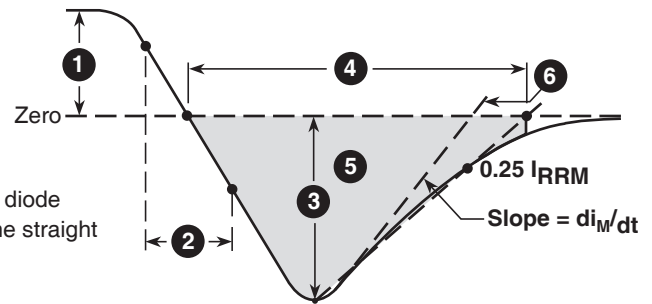

Figure 10, Diode Reverse Recovery Waveform and Definitions

TO-247 (BCT) Package Outline

