

STANDARD MICROSYSTEMS CORPORATION

35 Marcus Blvd., Hauppauge, N.Y. 11788
(516) 273-3100 TWX-510-227-8898

COM82586

T-75-49

Ethernet™ Local Area Network Coprocessor

FEATURES

- Performs Complete CSMA/CD Medium Access Control Functions Independently of CPU
 - High Level Command Interface
- Supports Established LAN Standards
 - IEEE 802.3/Ethernet™ (10BASE5)
 - IEEE 802.3/Cheapernet (10BASE2)
 - IBM PC Network
 - IEEE 802.3/StarLAN (1BASE5)
 - Proprietary CSMA/CD Networks up to 10 Mbps
- On-Chip Memory Management
 - Automatic Buffer Chaining
 - Buffer Reclaim After Receipt of Bad Frames
 - Save Bad Frames, Optionally
- Interfaces to 8-bit and 16-bit Microprocessors
- Supports Minimum Component Systems
 - Shared Bus Configuration
 - Interface to IAPX 186 and 188 Microprocessors without Glue
- Supports High Performance Systems
 - Bus Master, with On-Chip DMA
 - 5 MBytes/Sec Bus Bandwidth
 - Compatible with Dual Port Memory
 - Back to Back Frame Reception at 10 Mbps
- 48 Pin DIP and 68 Pin PLCC

PIN CONFIGURATION

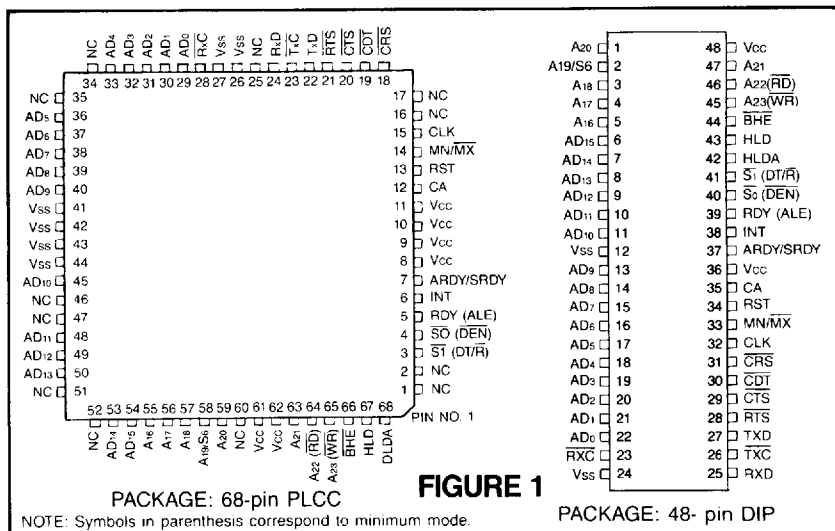

- Network Management
 - CRC Error Tally
 - Alignment Error Tally
 - Location of Cable Faults
- Self-Test Diagnostics
 - Internal Loopback
 - External Loopback
 - Internal Register Dump
 - Backoff Timer Check
- Single +5 volt supply
- Direct replacement for Intel's 82586

GENERAL DESCRIPTION

The COM82586 is an intelligent, high performance Local Area Network coprocessor, implementing the CSMA/CD access method (Carrier Sense Multiple Access with Collision Detection). It performs all time-crystal functions independently of the host processor, which maximizes performance and network efficiency.

The COM82586 performs the full set of IEEE 802.3 CSMA/CD media access control and channel interface functions including: framing, preamble generation and stripping, source address generation, destination address checking, CRC generation and checking, short frame detection. Any data rate up to 10 Mb/s can be used.

The COM82586 features a powerful host system interface. It automatically manages memory structures with command chaining and bidirectional data chaining. An on-chip DMA controller manages 4 channels transparently to the user. Buffers containing errored or collided frames can be automatically recovered. The 82586 can be configured for 8-bit or 16-bit data path, with maximum burst transfer rate of 2 or 4 Mbyte/sec. respectively. Memory address space is 16 Mbyte maximum.

The COM82586 provides two independent 16 byte FIFOs, Ethernet™ is a trademark of the Xerox Corporation.

one for receiving and one for transmitting. The threshold for block transfer to/from memory is programmable, enabling the user to optimize bus overhead for a given worst case bus latency.

The COM82586 provides a rich set of diagnostic and network management functions including: internal and external loopbacks, exception condition tallies, channel activity indicators, optional capture of all frames regardless of destination address, optional capture of errored or collided frames, and time domain reflectometry for locating faults in the cable.

The COM82586 can be used in either baseband or broadband networks. It can be configured for maximum network efficiency (minimum contention overhead) for any length network operating at any data rate up to 10 Mb/s. The controller supports address field lengths of 1, 2, 3, 4, 5, or 6 bytes. It can be configured for either the IEEE 802.3/Ethernet™ or HDLC method of frame delineation. Both 16-bit and 32-bit CRC are supported.

The COM82586 is available in a 48 pin DIP or 68 pin PLCC package.

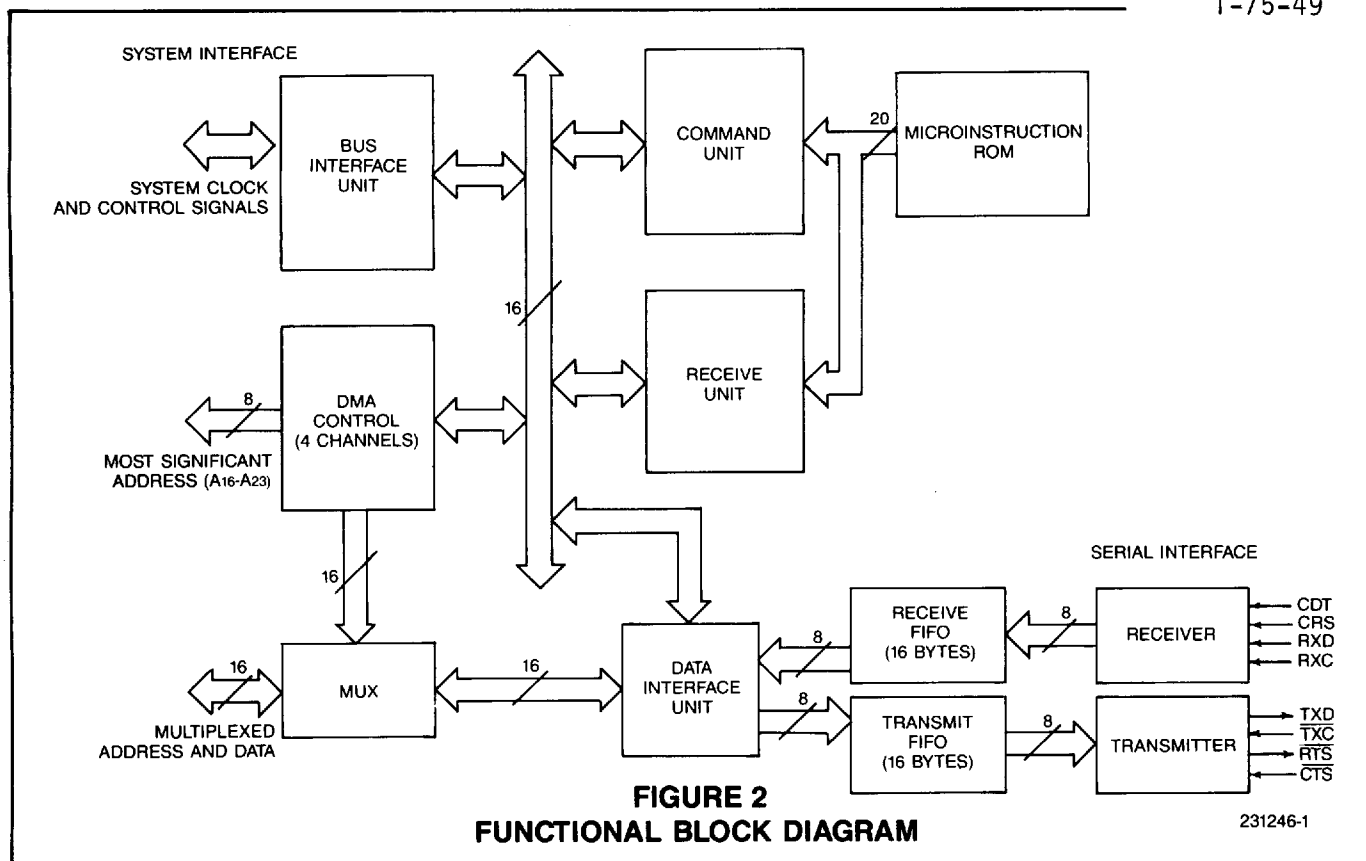

DESCRIPTION OF PIN FUNCTIONS

48 PIN DIP PIN NO.	68 PIN PLCC PIN NO.	NAME	SYMBOL	FUNCTION
48, 36	8, 9, 10, 11, 61, 62	Power Supply	V _{CC} , V _{CC}	+5V Power Supply.
12, 24	26, 27, 41, 42, 43, 44	Ground	V _{SS} , V _{SS}	System Ground.
34	13	Reset	RST	RST is an active HIGH internally synchronized signal, causing the 82586 to terminate present activity immediately. The signal must be HIGH for at least four clock cycles. The 82586 will execute RST within ten system clock cycles starting from RST HIGH. When RST returns LOW, the 82586 waits for the first CA to begin the initialization sequence.
27	22	Transmitted Serial Data	TxD	Output signal. This signal is HIGH when not transmitting.
26	23	Transmit Data Clock	TxC	This signal provides timing information to the internal serial logic, depending upon the mode of data transfer. For NRZ mode of operation, data is transferred to the TxD pin on the HIGH to LOW clock transition.
25	24	Received Data	RxD	Received Data Input Signal.
23	28	Received Data Clock	RxC	This signal provides timing information to the internal shifting logic depending upon the mode of data transfer. For NRZ data, the state of the RxD pin is sampled on the HIGH to LOW clock transition.
28	21	Request To Send	RTS	When LOW, this signal notifies an external interface that the 82586 has data to transmit. It is forced HIGH after a Reset and while the Transmit Serial Unit is not sending data.
29	20	Clear To Send	CTS	Active LOW Clear To Send input enables the 82586 transmitter to actually send data. It is normally used as an interface handshake to RTS. This signal going inactive stops transmission. It is internally synchronized. If CTS goes inactive, meeting the setup time to TxC negative edge, transmission is stopped and RTS goes inactive within, at most, two TxC cycles.

T-75-49

48 PIN DIP PIN NO.	68 PIN PLCC PIN NO.	NAME	SYMBOL	FUNCTION
31	18	Carrier Sense	CRS	Active LOW Carrier Sense input used to notify the 82586 that there is traffic on the serial link. It is used only if the 82586 is configured for external Carrier Sense. When so configured, external circuitry is required for detecting serial link traffic. It is internally synchronized. To be accepted, the signal must stay active for at least two serial clock cycles.
30	19	Collision Detect	CDT	Active LOW Collision Detect input is used to notify the 82586 that a collision has occurred. It is used only if the 82586 is configured for external Collision Detect. External circuitry is required for detecting the collision. It is internally synchronized. To be accepted, the signal must stay active for at least two serial clock cycles. During transmission, the 82586 is able to recognize a collision one bit time after preamble transmission has begun.
38	6	Interrupt	INT	Active HIGH interrupt request signal.
32	15	Clock	CLK	The system clock input from the 80186 or another symmetric clock generator.
33	14	Minimum Mode/ Maximum Mode	MN/MX	When HIGH, MN/MX selects \overline{RD} , \overline{WR} , \overline{ALE} , \overline{DEN} , $\overline{DT}/\overline{R}$ (Minimum Mode). When LOW, MN/MX selects A22, A23, READY, S0, S1 (Maximum Mode). Note: This pin should be static during 82586 operation.
6-11, 13-22	29-33, 36- 40, 45, 48, 49, 50, 53, 54	Address and Data Bus	AD0- AD15	These lines from the time multiplexed memory address (t1) and data (t2, t3, tW, 14) bus. When operating with an 8-bit bus, the high byte will output the address during the entire cycle. AD0-AD15 are floated after a RESET or when the bus is not acquired.
1, 3-5 45-47	55-57, 59, 63-65	Address Bus	A16-A18 A20-A23	These lines constitute 7 out of 8 most significant address bits for memory operation. They switch during t1 and stay valid during the entire memory cycle. The lines are floated after RST or when the bus is not acquired. Address lines A22 and A23 are not available for use in minimum mode.
2	58	Address 19 or Status 6	A19/S6	During t1 this signal it forms line 19 of the memory address. During t2 through t4 it is used as a status indicating that this is a Master peripheral cycle, and is HIGH. Its timing is identical to that of AD0-AD15 during write operation.
43	67	Hold	HLD	HLD is an active HIGH signal used by the 82586 to request local bus mastership at the end of the current CPU bus transfer cycle, or at the end of the current DMA burst transfer cycle. In normal operation, HLD goes inactive before HLDA. The 82586 can be forced off the bus by HLDA going inactive. In this case, HLD goes inactive within four clock cycles in word mode and eight clock cycles in byte mode.
42	68	Hold Acknowledge	HLDA	HLDA is an active HIGH Hold Acknowledge signal indicating that the CPU has received the HLD request and that bus control has been relinquished to the 82586. It is internally synchronized. After HLD is detected as LOW, the processor drives HLDA LOW. Note, CONNECTING V _{CC} TO HLDA IS NOT ALLOWED because it will cause a deadlock. Users wanting to give permanent bus access to the 82586 should connect HLDA with HLD.
35	12	Channel Attention	CA	The CA pin is a Channel Attention input used by the CPU to initiate the 82586 execution of memory resident Command Blocks. The CA signal is synchronized internally. The signal must be HIGH for at least one system clock period. It is latched internally on HIGH to LOW edge and then detected by the 82586.
44	66	Bus High Enable	BHE	The Bus High Enable signal (\overline{BHE}) is used to enable data onto the most significant half of the data bus. Its timing is identical to that of A16-A23. With a 16-bit bus it is LOW and with an 8-bit bus it is HIGH. Note: after RST, the 82586 is configured to 8-bit bus.

48 PIN DIP PIN NO.	68 PIN PLCC PIN NO.	NAME	SYMBOL	FUNCTION															
39	5	Ready	RDY	This active HIGH signal is the acknowledgement from the addressed memory that the transfer cycle can be completed. While LOW, it causes wait states to be inserted. This signal must be externally synchronized with the system clock. The Ready signal internal to the 82586 is a logical OR between RDY and SRDY/ARDY.															
37	7	Synch/Asynch Ready	ARDY/ SRDY	This active HIGH signal performs the same function as RDY. If it is programmed at configure time to SRDY, it is identical to RDY. If it is programmed to ARDY, the positive edge of the Ready signal is internally synchronized. Note, the negative edge must still meet setup and hold time specifications, when in ARDY mode. The ARDY signal must be active for at least one system clock HIGH period for proper strobing. The Ready signal internal to the 82586 is a logical OR between RDY (in Maximum Mode only) and SRDY/ARDY. Note that following RST, this pin assumes ARDY mode.															
40, 41	4, 3	Status 0, 1	$\overline{S0}$, $\overline{S1}$	Maximum mode only. These status pins define the type of DMA transfer during the current memory cycle. They are encoded as follows: <table style="margin-left: 20px;"> <tr> <td>$\overline{S1}$</td> <td>$\overline{S0}$</td> <td>Not Used</td> </tr> <tr> <td>0</td> <td>0</td> <td>Not Used</td> </tr> <tr> <td>0</td> <td>1</td> <td>Read Memory</td> </tr> <tr> <td>1</td> <td>0</td> <td>Write Memory</td> </tr> <tr> <td>1</td> <td>1</td> <td>Passive</td> </tr> </table> Status is active from the middle of t4 to the end of t2. They return to the passive state during t3 or during tW when RDY or ARDY is HIGH. These signals can be used by the 8288 Bus Controller to generate all memory control and timing signals. Any change from the passive state signals the 8288 to start the next t1 to t4 bus cycle. These pins are pulled HIGH and floated after a system RST and when the bus is not acquired.	$\overline{S1}$	$\overline{S0}$	Not Used	0	0	Not Used	0	1	Read Memory	1	0	Write Memory	1	1	Passive
$\overline{S1}$	$\overline{S0}$	Not Used																	
0	0	Not Used																	
0	1	Read Memory																	
1	0	Write Memory																	
1	1	Passive																	
46	64	Read	\overline{RD}	Used in minimum mode only. The read strobe indicates that the 82586 is performing a memory read cycle. \overline{RD} is active LOW during t2, t3 and tW of any read cycle. This signal is pulled HIGH and floated after a RST and when the bus is not acquired.															
45	65	Write	WR	Used in minimum mode only. The write strobe indicates that the 82586 is performing a write memory cycle. WR is active LOW during t2, t3 and tW of any write cycle. It is pulled HIGH and floats after RST and when the bus is not acquired.															
39	5	Address Latch Enable	ALE	Used in minimum mode only. Address Latch Enable is provided by the 82586 to latch the address into the 8282/8283 address latch. It is a HIGH pulse, during t1 ('clock low') of any bus cycle. Note that ALE is never floated.															
40	4	Data Enable	\overline{DEN}	Used in minimum mode only. Data ENable is provided as output enable for the 8286/8287 transceivers in a stand-alone (no 8288) system. DEN is active LOW during each memory access. For a read cycle, it is active from the middle of t2 until the beginning of t4. For a write cycle, it is active from the beginning of t2 until the middle of t4. It is pulled HIGH and floats after a system RST or when the bus is not acquired.															
41	3	Data I/O Control	DT/ \overline{R}	Used in minimum mode only. DT/ \overline{R} is used in non-8288 systems using an 8286/8287 data bus transceiver. It controls the direction of data flow through the Transceiver. Logically, DT/ \overline{R} is equivalent to $\overline{S1}$. It becomes valid in the t4 preceding a bus cycle and remains valid until the final t4 of the cycle. This signal is pulled HIGH and floated after a RST or when the bus is not acquired.															

82586/HOST CPU INTERACTION

Communication between the 82586 and the host is carried out via shared memory. The 82586's on-chip DMA capability allows autonomous transfer of data blocks (buffers, frames) and relieves the CPU of byte transfer overhead. The 82586 is optimized to interface the iAPX 186, but due to the small number of hardware signals between the 82586 and the CPU, the 82586 can operate easily with other processors. The 82586/host interaction is explained separately in terms of the logical interface and the hardware bus interface.

The 82586 consists of two independent units: Command Unit (CU) and Receive Unit (RU). The CU executes commands from shared memory. The RU handles all activities related to frame reception. The CU and RU enable the 82586 to engage in the two types of activities simultaneously: the CU may be fetching and executing commands out of memory, and the RU may be storing received frames in memory. CPU intervention is only required after the CU executes a sequence of commands or the RU stores a sequence of frames.

The only hardware signals that connect the CPU and the 82586 are INTERRUPT and CHANNEL ATTENTION (see Figure 3). Interrupt is used by the 82586 to draw the CPU's attention to a change in the contents of the SCB. Channel Attention is used by the CPU to draw the 82586's attention.

82586 SYSTEM MEMORY STRUCTURE

The Shared Memory structure consists of four parts: Initialization Root, System Control Block (SCB),

Command List, and Receive Frame Area (RFA) (see Figure 4).

The Initialization Root is at a predetermined location in the memory space, (0FFFFFF6H), known to both the host CPU and the 82586. The root is accessed at initialization and points to the System Control Block.

The System Control Block (SCB) functions as a bidirectional mail drop between the host CPU, CU and RU. It is the central element through which the CPU and the 82586 exchange control and status information. The SCB consists of two parts, the first of which entails instructions from the CPU to the 82586. These include: control of the CU and RU (START, ABORT, SUSPEND, RESUME), a pointer to the list of commands for the CU, a pointer to the receive frame area, and a set of Interrupt acknowledge bits. The second entails status information keyed by the 82586 to the CPU, including: state of the CU and RU (e.g. IDLE, ACTIVE READY, SUSPENDED, NO RECEIVE RESOURCES), interrupts bits (command completed, frame received, CU not ready, RU not ready), and statistics (see Figure 4).

The Command List serves as a program for the CU. Individual commands are placed in memory units called a Command Block, or CB. CB's contain command specific parameters and command specific statuses. Specifically, these high level commands are called Action Commands (e.g. Transmit, Configure).

A specific command, Transmit, causes transmission of a frame by the 82586. The Transmit command block includes Destination Address, Length Field, and a pointer to a list of linked buffers that holds the frame to be constructed from several buffers scattered in memory. The Command Unit performs with-

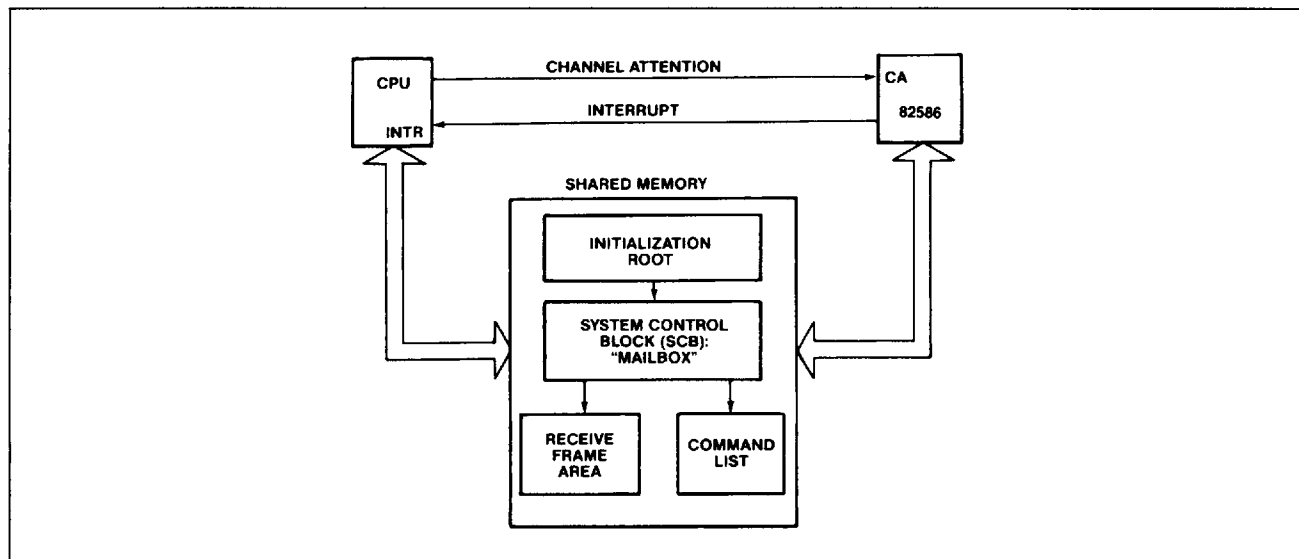

Figure 3. 82586/Host CPU Interaction

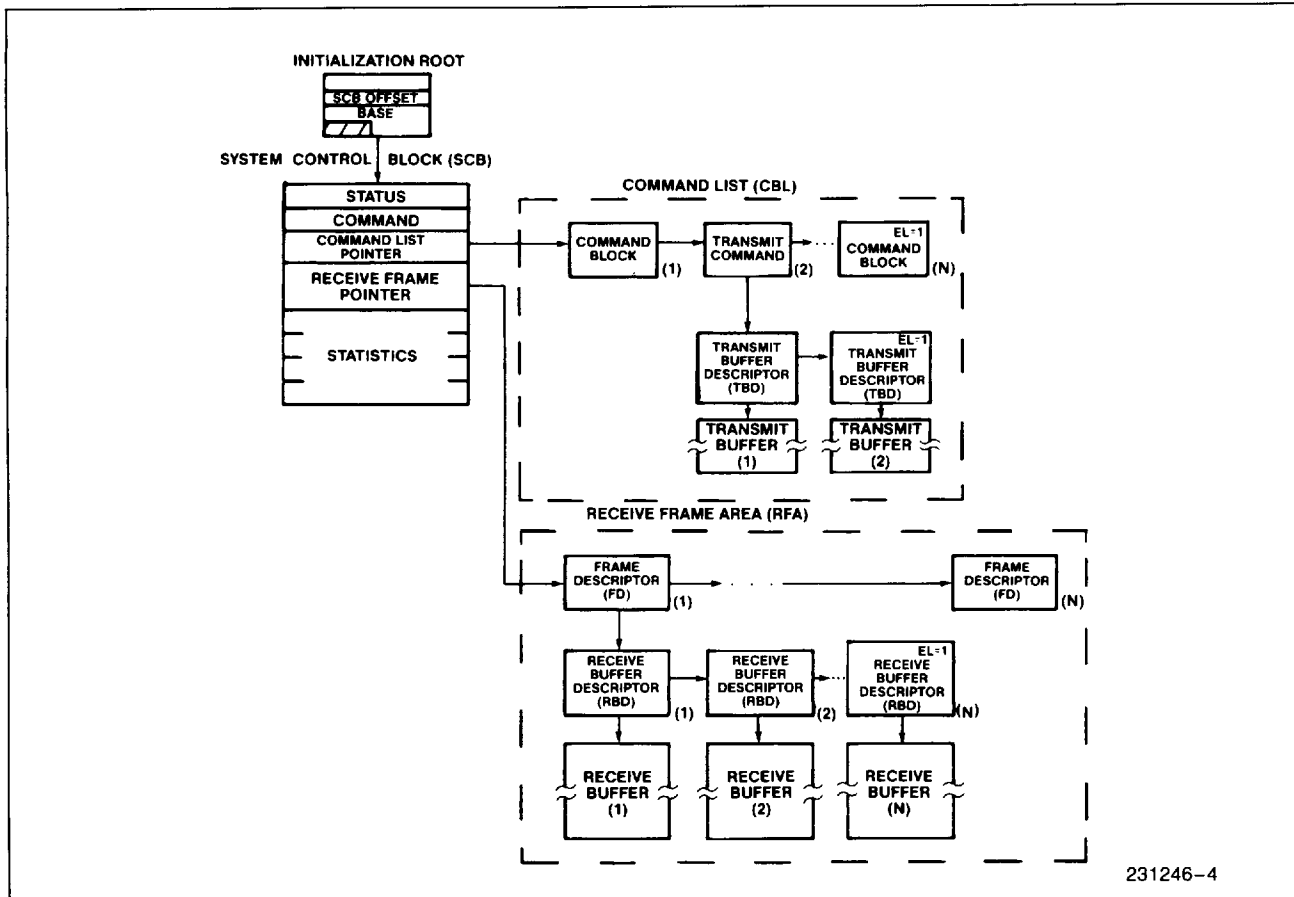

Figure 4. 82586 Shared Memory Structure

out the CPU intervention, the DMA of each buffer and the prefetching of references to new buffers in parallel. The CPU is notified only after successful transmission or retransmission.

The Receive Frame Area is a list of Free Frame Descriptors (Descriptors not yet used) and a list of buffers prepared by the user. It is conceptually distinct from the Command List. Frames arrive without being solicited by the 82586. The 82586 must be prepared to receive them even if it is engaged in other activities and to store them in the Free Frame Area. The Receive Unit fills the buffers upon frame reception and reformats the Free Buffer List into received frame structures. The frame structure is virtually identical to the format of the frame to be transmitted. The first frame descriptor is referenced by SCB. A Frame Descriptor and the associated Buffer Descriptor wasted upon receiving a Bad Frame (CRC or Alignment errored, Receive DMA overrun errored, or Collision fragmented frame) are automatically reclaimed and returned to the Free Buffer List, unless the chip is configured to Save Bad Frames.

Receive buffer chaining (i.e. storing incoming frames in a linked list of buffers) improves memory utilization significantly. Without buffer chaining, the user must allocate consecutive blocks of the maximum frame size (1518 bytes in Ethernet) for each frame. Taking into account that a typical frame size may be about 100 bytes, this practice is very inefficient. With buffer chaining, the user can allocate small buffers and the 82586 uses only as many as needed.

In the past, the drawback of buffer chaining was the CPU processing overhead and the time involved in the buffer switching (especially at 10 Mb/s). The 82586 overcomes this drawback by performing buffer management on its own for both transmission and reception (completely transparent to the user).

The 82586 has a 22-bit memory address range in minimum mode and 24-bit memory address range in maximum mode. All memory structures, the System Control Block, Command List, Receive Descriptor List, and all buffer descriptors must reside within one 64K-byte memory segment. The Data Buffers can be located anywhere in the memory space.

TRANSMITTING FRAMES

The 82586 executes high level action commands from the Command List in external memory. Action commands are fetched and executed in parallel with the host CPU's operation, thereby significantly improving system performance. The general action commands format is shown in Figure 5.

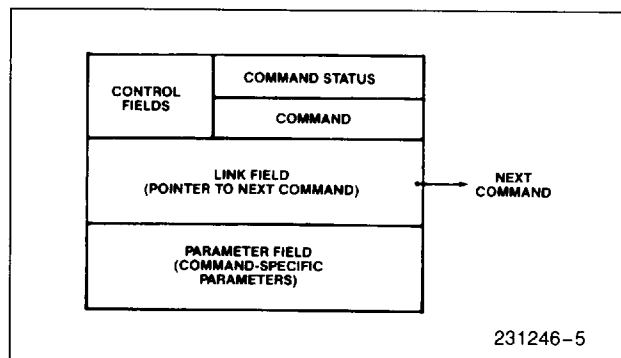

Figure 5. Action Command Format

Message transmission is accomplished by using the Transmit command. A single Transmit command contains, as part of the command-specific parameters, the destination address and length field for the transmitted frame along with a pointer to a buffer area in memory containing the data portion of the frame. (See Figure 15.) The data field is contained in a memory data structure consisting of a Buffer Descriptor (BD) and Data Buffer (or a linked list of buffer descriptors and buffers) as shown in Figure 6. The BD contains a Link Field which points to the next BD on the list and a 24-bit address pointing to the Data Buffer itself. The length of the Data Buffer is specified by the Actual Count field of the BD.

Using the BD's and Data Buffers, multiple Data Buffers can be 'chained' together. Thus, a frame with a long Data Field can be transmitted using multiple (shorter) Data buffers chained together. This chaining technique allows the system designer to develop efficient buffer management policies.

The 82586 automatically generates the preamble (alternating 1's and 0's) and start frame delimiter, fetches the destination address and length field from the Transmit command, inserts its unique address as the source address, fetches the data field from

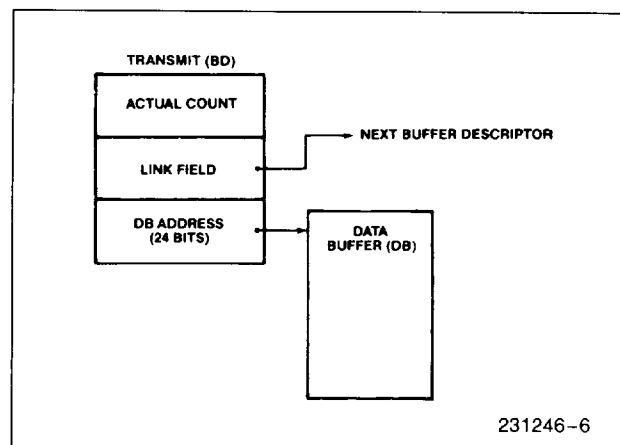

Figure 6. Data Buffer Descriptor and Data Buffer Structure

buffers pointed to by the Transmit command, and computes and appends the CRC at the end of the frame. See Figure 7.

The 82586 can be configured to generate either the Ethernet or HDLC start and end frame delimiters. In the Ethernet mode, the start frame delimiter is 10101011 and the end frame delimiter indicated by the lack of a signal after transmitting the last bit of the frame check sequence field. When in the HDLC mode, the 82586 will generate the 01111110 'flag' for the start and end frame delimiters and perform the standard 'bit stuffing/stripping'. In addition, the 82586 will optionally pad frames that are shorter than the specified minimum frame length by appending the appropriate number of flags to the end of the frame.

In the event of a collision (or collisions), the 82586 manages the entire jam, random wait and retry process, reinitializing DMA pointers without CPU intervention. Multiple frames can be sent by linking the appropriate number of Transmit commands together. This is particularly useful when transmitting a message that is larger than the maximum frame size (1518 bytes for Ethernet).

RECEIVING FRAMES

In order to minimize CPU overhead, the 82586 is designed to receive frames without CPU supervision. The host CPU first sets aside an adequate

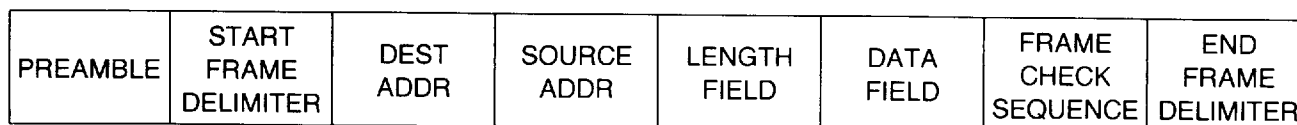

Figure 7. Frame Format

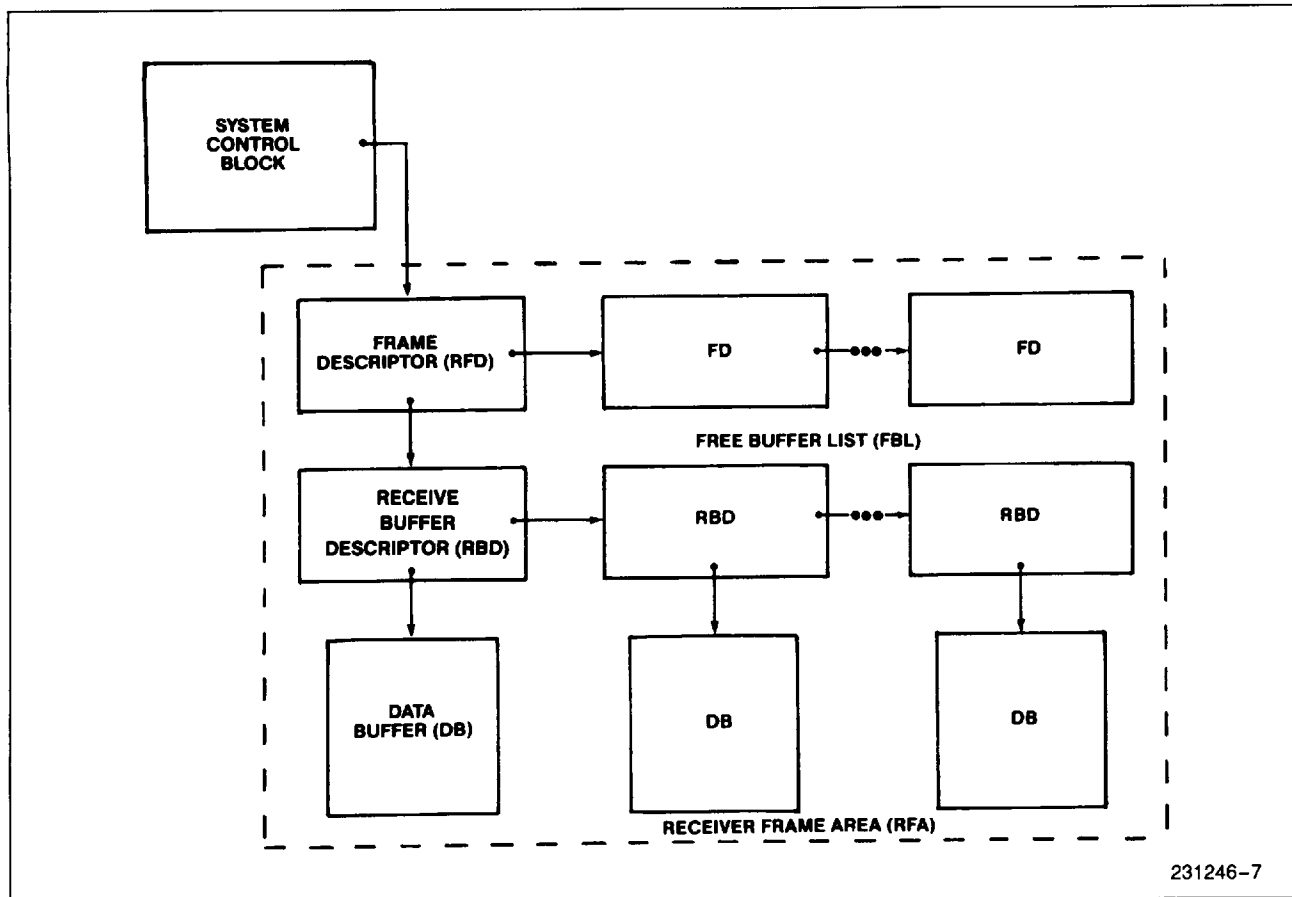

Figure 8. Receive Frame Area Diagram

amount of receive buffer space and then enables the 82586's Receive Unit. Once enabled, the RU 'watches' for any of its frames which it automatically stores in the Receive Frame Area (RFA). The RFA consists of a Receive Descriptor List (RDL) and a list of free buffers called the Free Buffer List (FBL) as shown in Figure 8. The individual Receive Frame Descriptors that make up the RDL are used by the 82586 to store the destination and source address, length field and status of each frame that is received. (Figure 9.)

The 82586, once enabled, checks each passing frame for an address match. The 82586 will recognize its own unique address, one or more multicast addresses or the broadcast address. If a match occurs, it stores the destination and source address and length field in the next available RFD. It then begins filling the next free Data Buffer on the FBL (which is pointed to by the current RFD) with the data portion of the incoming frame. As one DB is filled, the 82586 automatically fetches the next DB on the FBL until the entire frame is received. This buffer chaining technique is particularly memory efficient because it allows the system designer to set aside buffers that fit a frame size that may be much shorter than the maximum allowable frame.

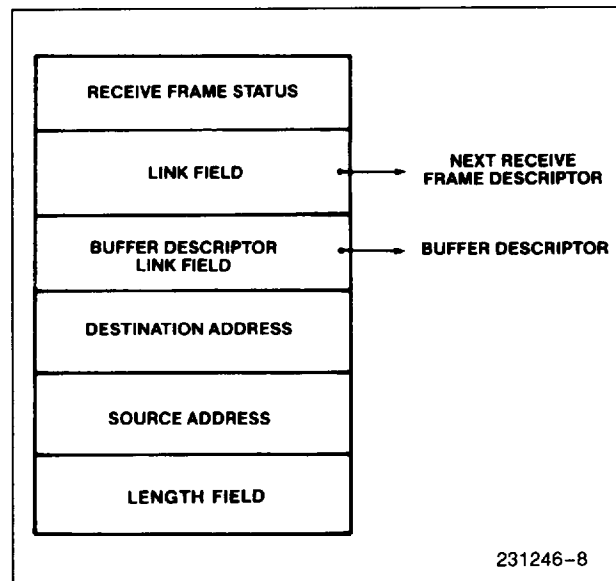

Figure 9. Receive Frame Descriptor

Once the entire frame is received without error, the 82586 performs the following housekeeping tasks:

- Updates the Actual Count field of the last Buffer Descriptor used to hold the frame just received with the number of bytes stored in its associated Data Buffer.

- Fetches the address of the next free Receive Frame Descriptor.
- Writes the address of the next free Buffer Descriptor into the next free Receive Frame Descriptor.
- Posts a 'Frame Received' interrupt status bit in the SCB.
- Interrupts the CPU.

In the event of a frame error, such as a CRC error, the 82586 automatically reinitializes its DMA pointers and reclaims any data buffers containing the bad frame. As long as Receive Frame Descriptors and data buffers are available, the 82586 will continue to receive frames without further CPU help.

82586 NETWORK MANAGEMENT AND DIAGNOSTIC FUNCTIONS

The behavior of data communication networks is typically very complex due to their distributed and asynchronous nature. It is particularly difficult to pinpoint a failure when it occurs. The 82586 was designed in anticipation of these problems and includes a set of features for improving reliability and testability.

The 82586 reports on the following events after each frame transmitted:

- Transmission successful.
- Transmission unsuccessful; lost Carrier Sense.
- Transmission unsuccessful; lost Clear-to-Send.
- Transmission unsuccessful; DMA underrun because the system bus did not keep up with the transmission.
- Transmission unsuccessful; number of collisions exceeded the maximum allowed.

The 82586 checks each incoming frame and reports on the following errors, (if configured to 'Save Bad Frame'):

- CRC error: incorrect CRC in a well aligned frame.
- Alignment error: incorrect CRC in a misaligned frame.
- Frame too short: the frame is shorter than the configured value for minimum frame length.
- Overrun: the frame was not completely placed in memory because the system bus did not keep up with incoming data.
- Out of buffers: no memory resources to store the frame, so part of the frame was discarded.

NETWORK PLANNING AND MAINTENANCE

To perform proper planning, operation, and maintenance of a communication network, the network management entity must accumulate information on network behavior. The 82586 provides a rich set of network-wide diagnostics that can serve as the basis for a network management entity.

Network Activity information is provided in the status of each frame transmitted. The activity indicators are:

- Number of collisions: number of collisions the 82586 experienced in attempting to transmit this frame.
- Deferred transmission: indicates if the 82586 had to defer to traffic on the link during the first transmission attempt.

Statistics registers are updated after each received frame that passes the address filtering, and is longer than the Minimum Frame Length configuration parameter.

- CRC errors: number of frames that experienced a CRC error and were properly aligned.
- Alignment errors: number of frames that experienced a CRC error and were misaligned.
- No-resources: number of correct frames lost due to lack of memory resources.
- Overrun errors: number of frame sequences lost due to DMA overrun.

The 82586 can be configured to Promiscuous Mode. In this mode it captures all frames transmitted on the Network without checking the Destination Address. This is useful in implementing a monitoring station to capture all frames for analysis.

The 82586 is capable of determining if there is a short or open circuit anywhere in the Network using the built in Time Domain Reflectometer (TDR) mechanism.

STATION DIAGNOSTICS

The chip can be configured to External Loopback. The transmitter to receiver interconnection can be placed anywhere between the 82586 and the link to locate faults, for example: the 82586 output pins, the Serial Interface Unit, the Transceiver cable, or in the Transceiver.

The 82586 has a mechanism recognizing the transceiver 'heart beat' signal for verifying the correct operation of the Transceiver's collision detection circuitry.

82586 SELF TESTING

The 82586 can be configured to Internal Loopback. It disconnects itself from the Serial Interface Unit, and any frame transmitted is received immediately. The 82586 connects the Transmit Data to the Receive Data signal and the Transmit Clock to the Receive Clock.

The Dump Command causes the chip to write over 100 bytes of its internal registers to memory.

The Diagnose command checks the exponential Backoff random number generator internal to the 82586.

CONTROLLING THE 82586

The CPU controls operation of the 82586's Command Unit (CU) and Receive Unit (RU) of the 82586 via the System Control Block.

THE COMMAND UNIT (CU)

The Command Unit is the logical unit that executes Action Commands from a list of commands very similar to a CPU program. A Command Block (CB) is associated with each Action Command.

The CU can be modeled as a logical machine that takes, at any given time, one of the following states:

- IDLE—CU is not executing a command and is not associated with a CB on the list. This is the initial state.
- SUSPENDED—CU is not executing a command but (different from IDLE) is associated with a CB on the list.
- ACTIVE—CU is currently executing an Action Command, and points to its CB.

The CPU may affect the CU operation in two ways: issuing a CU control Command or setting bits in the COMMAND word of the Action Command.

THE RECEIVE UNIT (RU)

The Receive Unit is the logical unit that receives frames and stores them in memory.

The RU is modeled as a logical machine that takes, at any given time, one of the following states:

- IDLE—RU has no memory resources and is discarding incoming frames. This is the initial RU state.
- NO-RESOURCES—RU has no memory resources and is discarding incoming frames. This state differs from the IDLE state in that RU accumulates statistics on the number of frames it had to discard.
- SUSPENDED—RU has free memory resources to store incoming frames but discard them anyway.

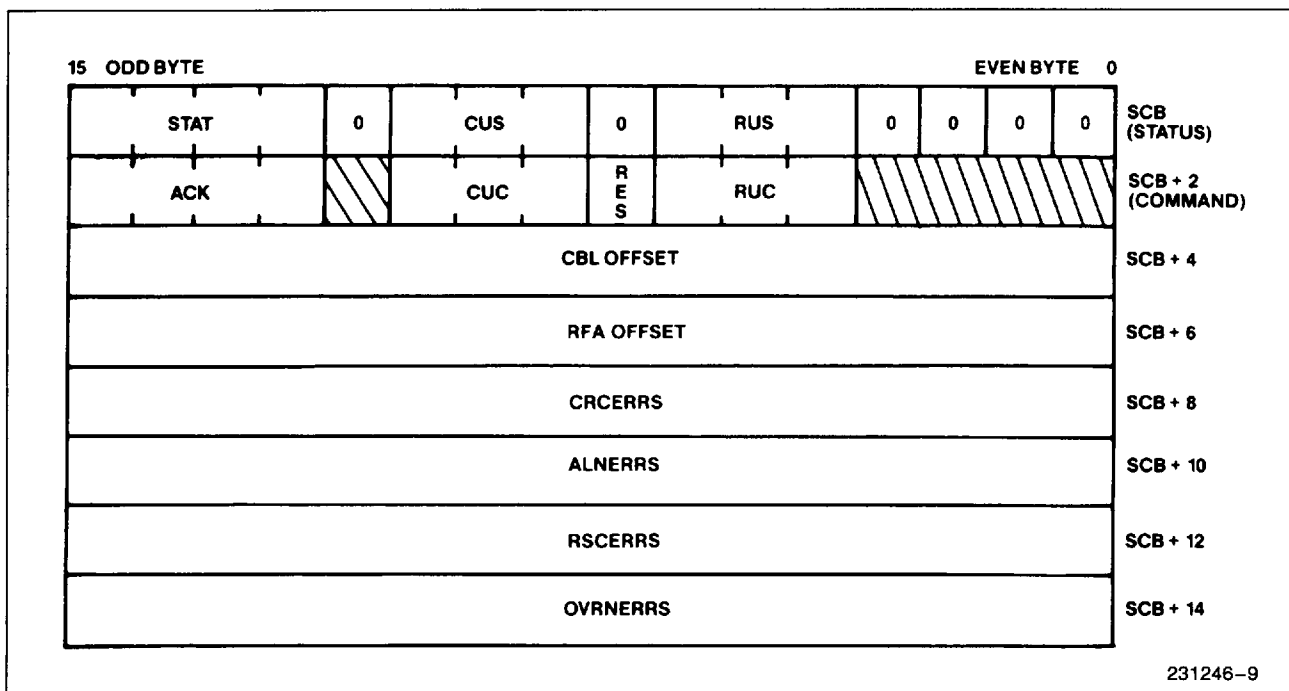

Figure 10. System Control Block (SCB) Format

- **READY**—RU has free memory resources and stores incoming frames.

The CPU may affect RU operation in three ways: issuing an RU Control Command, setting bits in Frame Descriptor, FD, **COMMAND** word of the frame currently being received, or setting EL bit of Buffer Descriptor, BD, of the buffer currently being filled.

SYSTEM CONTROL BLOCK (SCB)

The System Control Block is the communication mail-box between the 82586 and the host CPU. The SCB format is shown in Figure 10.

The host CPU issues Control Commands to the 82586 via the SCB. These commands may appear at any time during routine operation, as determined by the host CPU. After the required Control Command is setup, the CPU sends a CA signal to the 82586.

SCB is also used by the 82586 to return status information to the host CPU. After inserting the required status bits into SCB, the 82586 issues an Interrupt to the CPU.

The format is as follows:

STATUS word: Indicates the status of the 82586. This word is modified only by the 82586. Defined bits are:

CX	(Bit 15)	<ul style="list-style-type: none"> • A command in the CBL having its 'I' (interrupt) bit set has been executed.
FR	(Bit 14)	<ul style="list-style-type: none"> • A frame has been received.
CNR	(Bit 13)	<ul style="list-style-type: none"> • The Command Unit left the Active state.
RNR	(Bit 12)	<ul style="list-style-type: none"> • The Receive Unit left the Ready state.
CUS	(Bits 8-10)	<ul style="list-style-type: none"> • (3 bits) this field contains the status of the Command Unit. Valid values are: 0 — Idle 1 — Suspended 2 — Active 3-7 — Not Used
RUS	(Bits 4-6)	<ul style="list-style-type: none"> • (3 bits) this field contains the status of the Receive Unit. Valid values are: 0 — Idle 1 — Suspended 2 — No Resources 3 — Not Used 4 — Ready 5-7 — Not Used

COMMAND word: Specifies the action to be performed as a result of the CA. This word is set by the CPU and cleared by the 82586. Defined bits are:

ACK-CX	(Bit 15)	<ul style="list-style-type: none"> • Acknowledges the command executed event.
ACK-FR	(Bit 14)	<ul style="list-style-type: none"> • Acknowledges the frame received event.
ACK-CNA	(Bit 13)	<ul style="list-style-type: none"> • Acknowledges that the Command Unit became not ready.
ACK-RNR	(Bit 12)	<ul style="list-style-type: none"> • Acknowledges that the Receive Unit became not ready.
CUC	(Bits 8-10)	<ul style="list-style-type: none"> • (3 bits) this field contains the command to the Command Unit.
	0	<ul style="list-style-type: none"> • NOP (doesn't affect current state of the unit).
	1	<ul style="list-style-type: none"> • Start execution of the first command on the CBL. If a command is in execution, then complete it before starting the new CBL. The beginning of the CBL is in CBL OFFSET.
	2	<ul style="list-style-type: none"> • Resume the operation of the command unit by executing the next command. This operation assumes that the command unit has been previously suspended.
	3	<ul style="list-style-type: none"> • Suspend execution of commands on CBL after current command is complete.
	4	<ul style="list-style-type: none"> • Abort execution of commands immediately.
	5-7	<ul style="list-style-type: none"> • Reserved, illegal for use.
RUC	(Bits 4-6)	<ul style="list-style-type: none"> • (3 bits) This field contains the command to the receive unit. Valid values are:
	0	<ul style="list-style-type: none"> • NCP (does not alter current state of unit).
	1	<ul style="list-style-type: none"> • Start reception of frames. If a frame is being received, then complete reception before starting. The beginning of the RFA is contained in the RFA OFFSET.
	2	<ul style="list-style-type: none"> • Resume frame receiving (only when in suspended state.)
	3	<ul style="list-style-type: none"> • Suspend frame receiving. If a frame is being received, then complete its reception before suspending.
	4	<ul style="list-style-type: none"> • Abort receiver operation immediately.
	5-7	<ul style="list-style-type: none"> • Reserved, illegal for use.
RESET	(Bit 7)	<ul style="list-style-type: none"> • Reset chip (logically the same as hardware RESET).

CBL-OFFSET:

Gives the 16-bit offset address of the first command (Action Command) in the command list to be executed following CU-START. Thus, the 82586 reads this word only if the CUC field contained a CU-START Control Command.

RFA-OFFSET:

Points to the first Receive Frame Descriptor in the Receive Frame Area.

CRCERRS:

CRC Errors - contains the number of properly aligned frames received with a CRC error.

ALNERRS:

Alignment Errors - contains the number of misaligned frames received with a CRC error.

RSCERRS:

Resource Errors - records the number of correct incoming frames discarded due to lack of memory resources (buffer space or received frame descriptors).

OVRNERRS:

Overflow Errors - counts the number of received frame sequences lost because the memory bus was not available in time to transfer them.

ACTION COMMANDS

The 82586 executes a 'program' that is made up of action commands in the Command List. As shown in

Figure 5, each command contains the command field, status and control fields, link to the next action command in the CL, and any command-specific parameters. This command format is called the Command Block.

The 82586 has a repertoire of 8 commands:

- NOP
- Setup Individual Address
- Configure
- Setup Multicast Address
- Transmit
- TDR
- Diagnose
- Dump

NOP

This command results in no action by the 82586, except as performed in normal command processing. It is present to aid in Command List manipulation.

NOP command includes the following fields:

STATUS word (written by 82586):

C	(Bit 15)	• Command Completed
B	(Bit 14)	• Busy Executing Command
OK	(Bit 13)	• Error Free Completion

COMMAND word:

EL	(Bit 15)	• End of Command List
S	(Bit 14)	• Suspend After Completion
I	(Bit 13)	• Interrupt After Completion
CMD	(Bits 0-2)	• NOP = 0

LINK OFFSET: Address of next Command Block

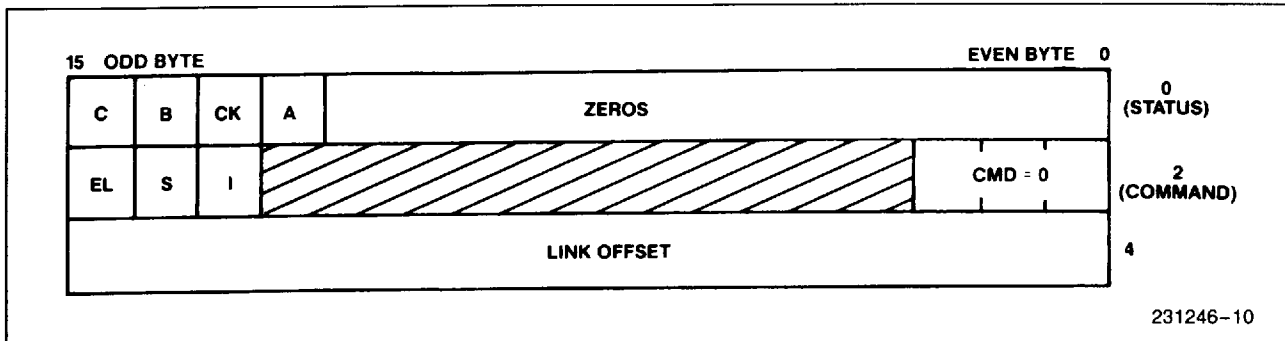

Figure 11. The NOP Command Block

82586

IA-SETUP

This command loads the 82586 with the Individual Address. This address is used by the 82586 for recognition of Destination Address during reception and insertion of Source Address during transmission.

The IA-SETUP command includes the following fields:

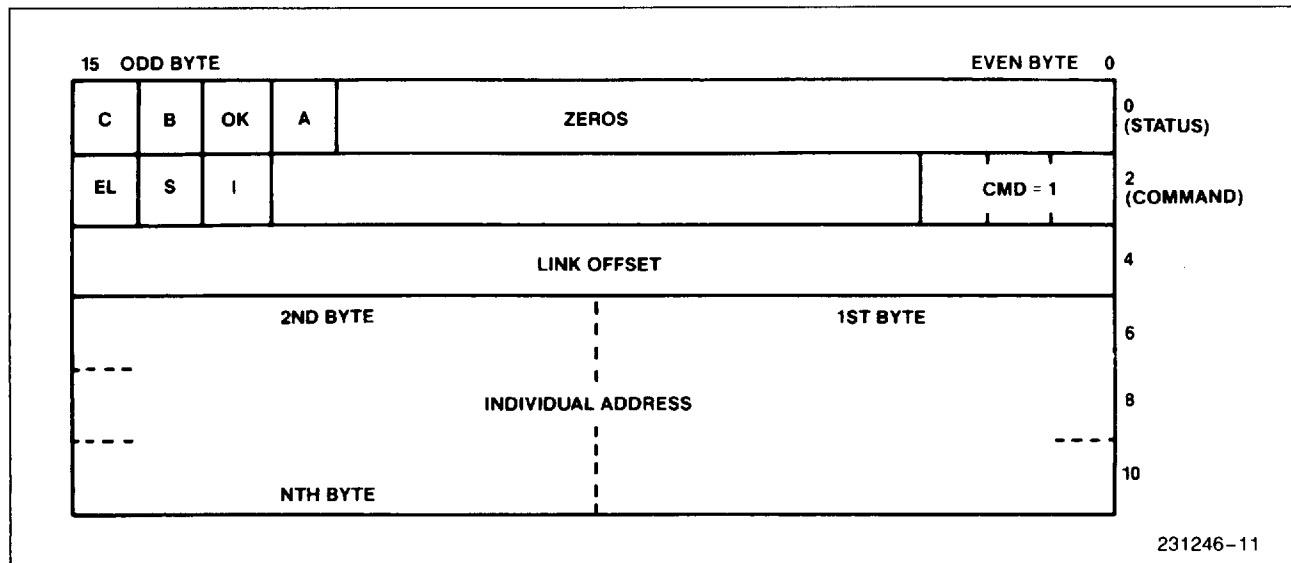

Figure 12. The IA-SETUP Command Block

STATUS word (written by 82586).

C	(Bit 15)	• Command Completed
B	(Bit 14)	• Busy Executing Command
OK	(Bit 13)	• Error Free Completion
A	(Bit 12)	• Command Aborted

COMMAND word:

EL	(Bit 15)	• End of Command List
S	(Bit 14)	• Suspend After Completion
I	(Bit 13)	• Interrupt After Completion
CMD	(Bits 0-2)	• IA-SETUP = 1

LINK OFFSET: Address of next Command Block

INDIVIDUAL ADDRESS: Individual Address parameter

The least significant bit of the Individual Address parameter must be zero for IEEE 802.3/Ethernet. However, no enforcement of 0 is provided by the 82586. Thus, an Individual Address with least significant bit 1, is possible.

CONFIGURE

The CONFIGURE command is used to update the 82586 operating parameters.

The CONFIGURE command includes the following fields:

STATUS word (written by 82586):

C	(Bit 15)	• Command Completed
B	(Bit 14)	• Busy Executing Command
OK	(Bit 13)	• Error Free Completion
A	(Bit 12)	• Command Aborted

COMMAND word:

EL	(Bit 15)	• End of Command List
S	(Bit 14)	• Suspend After Completion
I	(Bit 13)	• Interrupt After Completion
CMD	(Bits 0-2)	• Configure = 2

LINK OFFSET: Address of next Command Block

Byte 6-7:

BYTE CNT	(Bits 0-3)	• Byte Count, Number of bytes including this one, holding the parameters to be configured. A number smaller than 4 is interpreted as 4. A number greater than 12 is interpreted as 12.
----------	------------	----------------------------------------------------------------------------------------------------------------------------------------------------------------------------------------

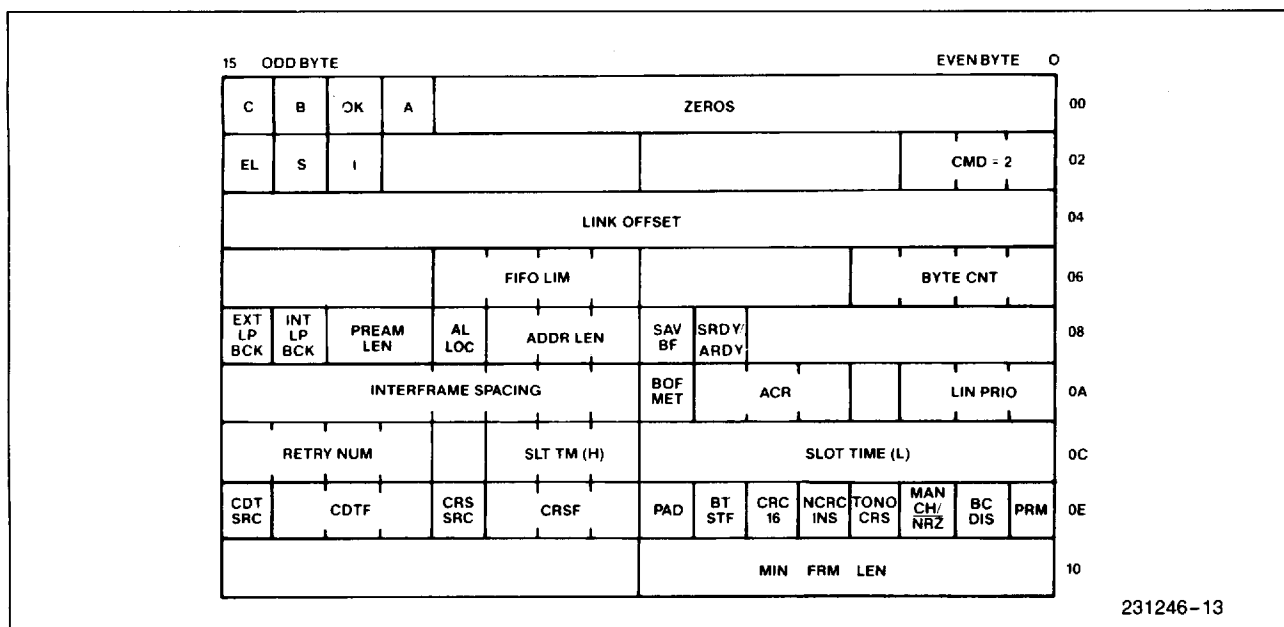

Figure 13. The CONFIGURE Command Block

FIFO-LIM	(Bits 8-11)	<ul style="list-style-type: none"> Value of FIFO Threshold.
----------	-------------	----------------------------------------------------------------------------

Byte 8-9:

SRDY/ARDY	(Bit 6)	<ul style="list-style-type: none"> SRDY/ARDY pin operates as ARDY (internal synchronization). SRDY/ARDY pin operates as SRDY (external synchronization).
	0	
	1	
SAV-BF	(Bit 7)	<ul style="list-style-type: none"> Received bad frames are not saved in memory. Received bad frames are saved in memory.
	0	
	1	
ADD-LEN	(Bits 8-10)	<ul style="list-style-type: none"> Number of address bytes. NOTE: 7 is interpreted as 0.
AL-LOC	(Bit 11)	<ul style="list-style-type: none"> Address and Length Fields separated from data and associated with Transmit Command Block or Receive Frame Descriptor. For transmitted Frame, Source Address is inserted by the 82586.
	0	

	1	<ul style="list-style-type: none"> Address and Length Fields are part of the Transmit/Receive data buffers, including Source Address (which is not inserted by the 82586). Preamble Length including Beginning of Frame indicator: 00 - 2 bytes 01 - 4 bytes 10 - 8 bytes 11 - 16 bytes Internal Loopback External Loopback. NOTE: Bits 14 and 15 configured to 1, cause Internal Loopback.
PREAM-LEN	(Bits 12-13)	
INT-LPBCK	(Bit 14)	
EXT-LPBCK	(Bit 15)	

Byte 10-11:

LIN-PRIO	(Bits 0-2)	<ul style="list-style-type: none"> Linear Priority Accelerated Contention Resolution (Exponential Priority)
ACR	(Bits 4-6)	
BOF-MET	(Bit 7)	<ul style="list-style-type: none"> Exponential Backoff Method 0 - IEEE 802.3/Ethernet 1 - Alternate Method

INTER FRAME SPACING	(Bits 8-15)	<ul style="list-style-type: none"> • Number indicating the Interframe Spacing in TxC period units.
---------------------	-------------	-------------------------------------------------------------------------------------------------------------------

Byte 12-13:

SLOT-TIME (L)	(Bits 0-7)	<ul style="list-style-type: none"> • Slot Time Number, Low Byte
SLT-TM (H)	(Bits 8-10)	<ul style="list-style-type: none"> • Slot Time Number, High Bits
RETRY-NUM	(Bits 12-15)	<ul style="list-style-type: none"> • Maximum Number of Transmission Retries on Collisions

Byte 14-15:

PRM	(Bit 0)	<ul style="list-style-type: none"> • Promiscuous Mode
BC-DIS	(Bit 1)	<ul style="list-style-type: none"> • Broadcast Disable
MANCH/ NRZ	(Bit 2)	<ul style="list-style-type: none"> • Manchester or NRZ
	0	<ul style="list-style-type: none"> • Encoding/Decoding
	1	<ul style="list-style-type: none"> • NRZ
TONO-CRS	(Bit 3)	<ul style="list-style-type: none"> • Manchester
	0	<ul style="list-style-type: none"> • Transmit on No Carrier Sense
	1	<ul style="list-style-type: none"> • Cease Transmission if CRS Goes Inactive During Frame Transmission
NCRC-INS	(Bit 4)	<ul style="list-style-type: none"> • Continue Transmission Even if no Carrier Sense
CRC-16	(Bit 5)	<ul style="list-style-type: none"> • No CRC Insertion
	0	<ul style="list-style-type: none"> • CRC Type:
	1	<ul style="list-style-type: none"> • 32 bit Autodin II CRC Polynomial
BT-STF	(Bit 6)	<ul style="list-style-type: none"> • 16 bit CCITT CRC Polynomial
	0	<ul style="list-style-type: none"> • Bitstuffing:
	1	<ul style="list-style-type: none"> • End of Carrier Mode (Ethernet)
PAD	(Bit 7)	<ul style="list-style-type: none"> • HDLC like Bitstuffing Mode
	0	<ul style="list-style-type: none"> • Padding
	1	<ul style="list-style-type: none"> • No Padding
		<ul style="list-style-type: none"> • Perform Padding by Transmitting Flags for Remainder of Slot Time
CRSF	(Bits 8-9)	<ul style="list-style-type: none"> • Carrier Sense Filter in Bit Times
CRS-SRC	(Bit 11)	<ul style="list-style-type: none"> • Carrier Sense Source
	0	<ul style="list-style-type: none"> • External
	1	<ul style="list-style-type: none"> • Internal

CDTF	(Bits 12-14)	<ul style="list-style-type: none"> • Collision Detect Filter in Bit Times
CDT-SRC	(Bit 15)	<ul style="list-style-type: none"> • Collision Detect Source
	0	<ul style="list-style-type: none"> • External
	1	<ul style="list-style-type: none"> • Internal

Byte 16:

MIN-FRM-	(Bits 0-7)	<ul style="list-style-type: none"> • Minimum Number of Bytes in a Frame
----------	------------	----------------------------------------------------------------------------------------

CONFIGURATION DEFAULTS

The default values of the configuration parameters are compatible with the IEEE 802.3/Ethernet Standards. RESET configures the 82586 according to the defaults shown in Table 2.

Table 2. 82586 Default Values

Preamble Length (Bytes)	=	8
Address Length (Bytes)	=	6
Broadcast Disable	=	0
CRC-16/CRC-32	=	0
No CRC Insertion	=	0
Bitstuffing/EOC	=	0
Padding	=	0
Min-Frame-Length (Bytes)	=	64
Interframe Spacing	=	96
Slot Time	=	512
Number of Retries	=	15
Linear Priority	=	0
Accelerated Contention Resolution	=	0
Exponential Backoff Method	=	0
Manchester/NRZ	=	0
Internal CRS	=	0
CRS Filter	=	0
Internal CDT	=	0
CDT Filter	=	0
Transmit On No CRS	=	0
FIFO THRESHOLD	=	8
SRDY/ARDY	=	0
Save Bad Frame	=	0
Address/Length Location	=	0
INT Loopback	=	0
EXT Loopback	=	0
Promiscuous Mode	=	0

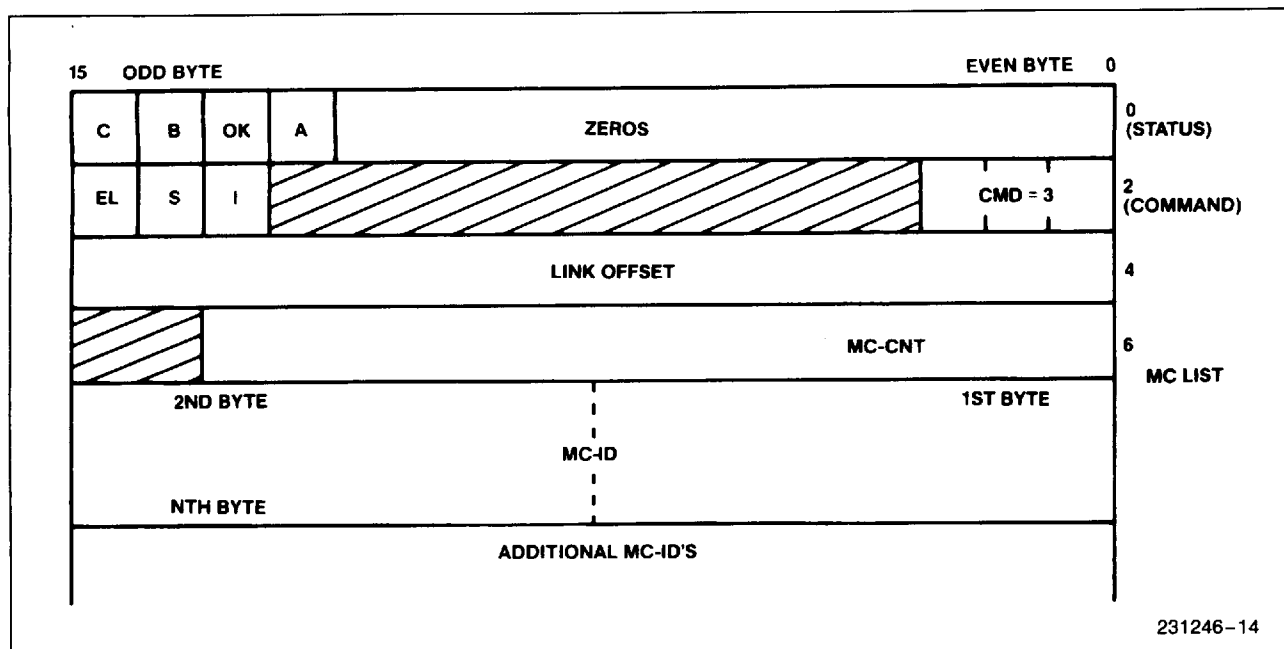

Figure 14. The MC-SETUP Command Block

MC-SETUP

This command sets up the 82586 with a set of Multicast Addresses. Subsequently, incoming frames with Destination Addresses from this set are accepted.

The MC-SETUP command includes the following fields:

STATUS word (written by 82586):

C	(Bit 15)	• Command Completed
B	(Bit 14)	• Busy Executing Command
OK	(Bit 13)	• Error Free Completion
A	(Bit 12)	• Command Aborted

COMMAND word:

EL	(Bit 15)	• End of Command List
S	(Bit 14)	• Suspend After Completion
I	(Bit 13)	• Interrupt After Completion
CMD	(Bits 0-2)	• MC-SETUP = 3

LINK OFFSET: Address of next Command Block

MC-CNT: A 14-bit field indicating the number of bytes in the MC-LIST field. MC-CNT is truncated to the nearest multiple of Address Length (in bytes).

Issuing a MC-SETUP command with MC-CNT=0 disables reception of any incoming frame with a Multicast Address.

MC-LIST: A list of Multicast Addresses to be accepted by the 82586. Note that the most significant byte of an address is followed immediately by the least significant byte of the next address. Note also that the least significant bit of each Multicast Address in the set must be a one.

The Transmit-Byte-Machine maintains a 64-bit HASH table used for checking Multicast Addresses during reception.

An incoming frame is accepted if it has a Destination Address whose least significant bit is a one, and after hashing points to a bit in the HASH table whose value is one. The hash function is selecting bits 2 to 7 of the CRC register. RESET causes the HASH table to become all zeros.

After the Transmit-Byte-Machine reads a MC-SETUP command from TX-FIFO, it clears the HASH table and reads the bytes in groups whose length is determined by the ADDRESS length. Each group is hashed using CRC logic and the bit in the HASH table to which bits 2-7 of the CRC register point is set to one. A group that is not complete has no effect on the HASH table. Transmit-Byte-Machine notifies CU after completion.

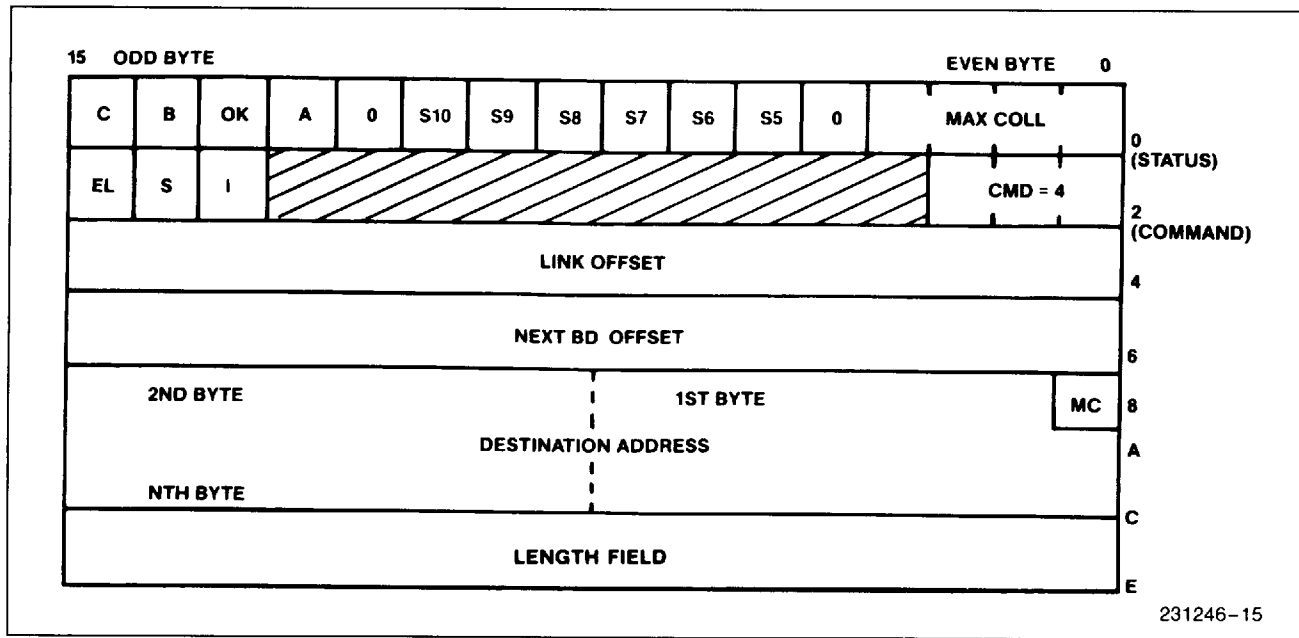

Figure 15. The Transmit Command Block

TRANSMIT

The TRANSMIT command causes transmission (and if necessary retransmission) of a frame.

TRANSMIT CB includes the following fields:

STATUS word (written by 82586):

C	(Bit 15)	• Command Completed
B	(Bit 14)	• Busy Executing Command
OK	(Bit 13)	• Error Free Completion
A	(Bit 12)	• Command Aborted
S10	(Bit 10)	• No Carrier Sense signal during transmission (between beginning of Destination Address and end of Frame Check Sequence).
S9	(Bit 9)	• Transmission unsuccessful (stopped) due to loss of Clear-to-Send signal.
S8	(Bit 8)	• Transmission unsuccessful (stopped) due to DMA underrun, (i.e. data not supplied from the system for transmission).
S7	(Bit 7)	• Transmission had to Defer to traffic on the link.

S6	(Bit 6)	• Heart Beat, indicates that during Interframe Spacing period after the previous transmission, a pulse was detected on the Collision Detect pin.
S5	(Bit 5)	• Transmission attempt stopped due to number of collisions exceeding the maximum number of retries.
MAX-COLL	(Bits 3-0)	• Number of Collisions experienced by this frame. S5 = 1 and MAX-COLL = 0 indicates that there were 16 collisions.
COMMAND word:		
EL	(Bit 15)	• End of Command List
S	(Bit 14)	• Suspend After Completion
I	(Bit 13)	• Interrupt After Completion
CMD	(Bits 0-2)	• TRANSMIT = 4

LINK OFFSET: Address of next Command Block

TBD OFFSET: Address of list of buffers holding the information field. TBD-OFFSET = 0FFFFH indicates that there is no Information field.

DESTINATION ADDRESS: Destination Address of the frame.

LENGTH FIELD: Length field of the frame.

STATUS word:

EOF		<ul style="list-style-type: none"> Indicates that this is the Buffer Descriptor of the last buffer of this frame's Information Field.
ACT-COUNT	(Bits 0-13)	<ul style="list-style-type: none"> Actual number of data bytes in buffer (can be even or odd).

NEXT BD OFFSET: points to next Buffer Descriptor in list. If EOF is set, this field is meaningless.

BUFFER ADDRESS: 24-bit absolute address of buffer.

TIME DOMAIN REFLECTOMETER - TDR

This command performs a Time Domain Reflectometer test on the serial link. By performing the command, the user is able to identify shorts or opens and their location. Along with transmission of 'All Ones,' the 82586 triggers an internal timer. The tim-

er measures the time elapsed from transmission start until 'echo' is obtained. 'Echo' is indicated by Collision Detect going active or Carrier Sense signal drop.

TDR command includes the following fields:

STATUS word (written by 82586):

C	(Bit 15)	• Command Completed
B	(Bit 14)	• Busy Executing Command
OK	(Bit 13)	• Error Free Completion

COMMAND word:

EL	(Bit 15)	• End of Command List
S	(Bit 14)	• Suspend After Completion
I	(Bit 13)	• Interrupt After Completion
CMD	(Bits 0-2)	• TDR = 5

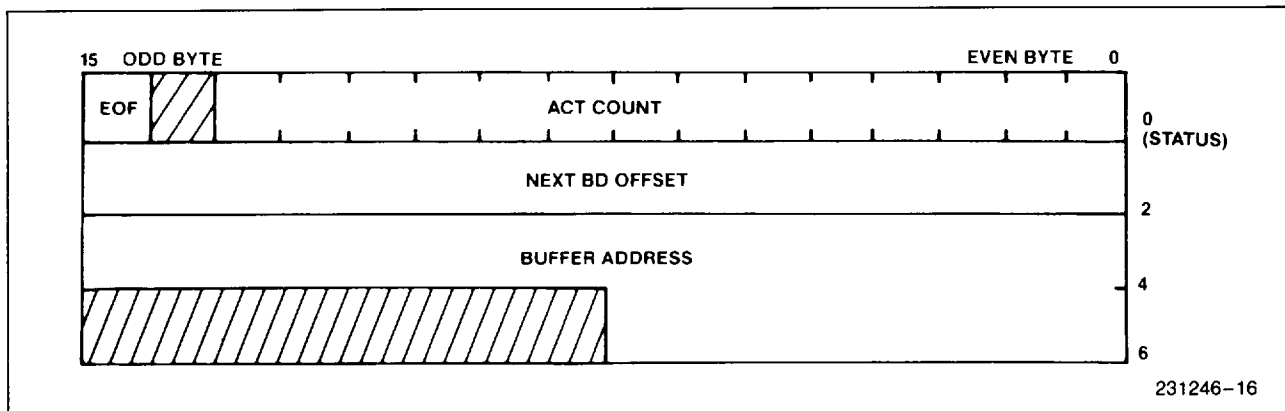

Figure 16. The Transmit Buffer Description

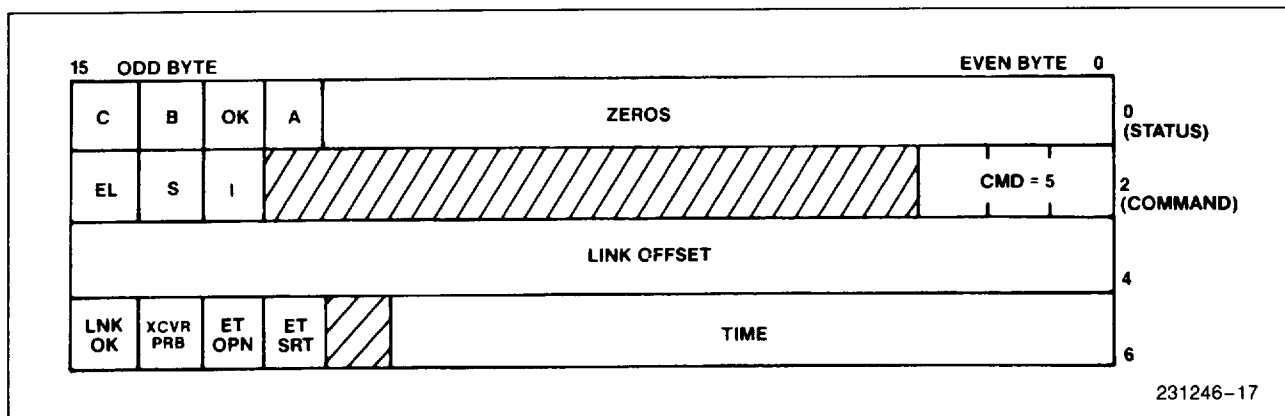

Figure 17. The TDR Command Block

LINK OFFSET: Address of next Command Block

RESULT word:

LNK-OK	(Bit 15)	• No Link Problem Identified
XCVR-PRB	(Bit 14)	• Transceiver Cable Problem identified (valid only in the case of a Transceiver that does not return Carrier Sense during transmission).
ET-OPN	(Bit 13)	• Open on the link identified (valid only in the case of a Transceiver that returns Carrier Sense during transmission).
ET-SRT	(Bit 12)	• Short on the link identified (valid only in the case of a Transceiver that returns Carrier Sense during transmission).
TIME	(Bits 0-10)	• Specifying the distance to a problem on the link (if one exists) in transmit clock cycles.

STATUS word (written by 82586):

C	(Bit 15)	• Command Completed
B	(Bit 14)	• Busy Executing Command
OK	(Bit 13)	• Error Free Completion

COMMAND word:

EL	(Bit 15)	• End of Command List
S	(Bit 14)	• Suspend After Completion
I	(Bit 13)	• Interrupt After Completion
CMD	(Bits 0-2)	• DUMP = 6

LINK OFFSET: Address of next Command Block

BUFFER OFFSET: This word specifies the offset portion of the memory address which points to the top of the buffer allocated for the dumped registers contents. The length of the buffer is 170 bytes.

DUMP AREA FORMAT

Figure 18 shows the format of the DUMP area. The fields are as follows:

Bytes 00H to 0AH: These bytes correspond to the 82586 CONFIGURE command field.

Bytes 0CH to 11H: The Individual Address Register content. IARO is the Individual Address least significant byte.

Bytes 12H to 13H: Status word of last command block (only bits 0-13).

DUMP

This command causes the contents of over a hundred bytes of internal registers to be placed in memory. It is supplied as a self diagnostic tool, as well as to supply registers of interest to the user.

DUMP command includes the following fields:

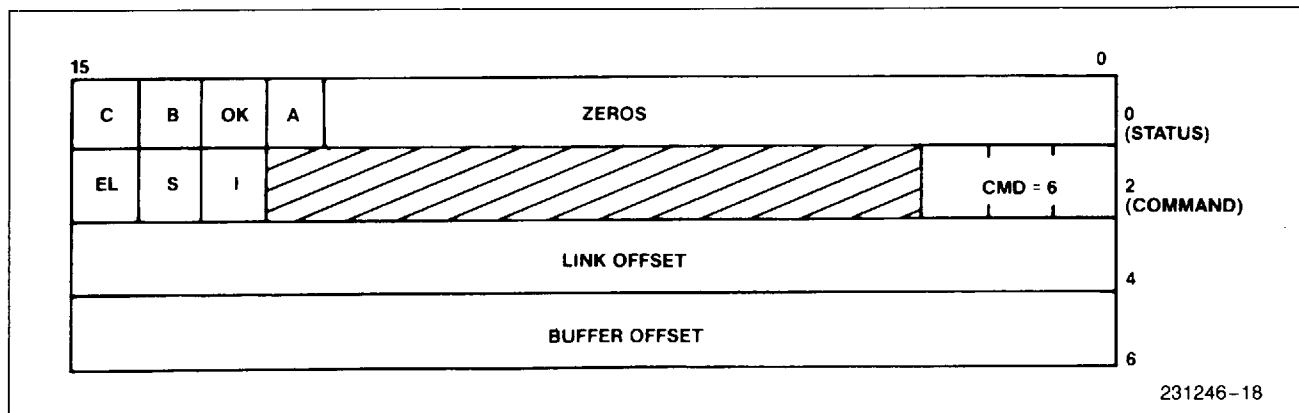

Figure 18. The DUMP Command Block

Bytes 18H to 1BH: Contents of Receive CRC Checker. RXCRCRO is the least significant byte. The contents are dependent on the activity performed before the DUMP command:

After RESET - 'All Ones.'

After good frame reception—

1. For CRC-CCITT - 01D0FH
2. For CRC-Autodin-II - C704DD7BH

After Bad Frame reception - corresponds to the received information.

After reception attempt, i.e. unsuccessful check for address match, corresponds to the CRC performed on the frame address.

NOTE:

Any frame on the serial link modifies this register contents.

Bytes 1CH to 21H: Temporary Registers.

Bytes 22H to 23H: Receive Status Register. Bits 6, 7, 8, 10, 11 and 13 assume the same meaning as corresponding bits in the Receive Frame Descriptor Status field.

Bytes 24H to 2BH: HASH TABLE.

Bytes 2CH to 2DH: Status bits of the last time TDR command that was performed.

NXT-RB-SIZE: Let N be the last buffer of the last received frame, then NXT-RB-SIZE is the number of bytes of available in the N + 1 buffer. EL - The EL bit of the Receive Buffer Descriptor.

NXT-RB-ADR: Let N be the last Receive Buffer used, then NXT-RB-ADR is the BUFFER-ADDRESS field in the N + 1 Receive-Buffer Descriptor, i.e. the pointer to the N + 1 Receive Buffer.

CUR-RB-SIZE: The number of bytes in the last buffer of the last received frame. EL - The EL bit of the last buffer in the last received frame.

LA-RBD-ADR: Look Ahead Buffer Descriptor, i.e. the pointer to N + 2 Receiver Buffer Descriptor.

NXT-RBD-ADR: Next Receive Buffer Descriptor Address. Similar to LA-RBD-ADR but points to N + 1 Receive Buffer Descriptor.

CUR-RBD-ADR: Current Receive Buffer Descriptor Address. Similar to LA-RBD-ADR, but point to Nth Receive Buffer Descriptor.

CUR-RB-EBC: Current Receive Buffer Empty Byte Count Let N be the currently used Receive Buffer. Then CUR-RB-EBC indicates the Empty part of the buffer, i.e. the ACT-COUNT of buffer N is given by the difference between its SIZE and the CUR-RB-EBC.

NXT-FD-ADR: Next Frame Descriptor Address. Define N as the last Receive Frame Descriptor with bits C = 1 and B = 0, then NXT-FD-ADR is the address of N + 2 Receive Frame Descriptor (with B = C = 0) and is equal to the LINK-ADDRESS field in N + 1 Receive Frame Descriptor.

CUR-FD-ADR: Current Frame Descriptor Address. Similar to next NXT-FD-ADR but refers to N + 1 Receive Frame Descriptor (with B = 1, C = 0).

Bytes 54H to 55H: Temporary register.

NXT-TB-CNT: Next Transmit Buffer Count. Let N be the last transmitted buffer of the TRANSMIT command executed recently, the NXT-TB-CNT is the ACT-COUNT field in the Nth Transmit Buffer Descriptor. EOF - Corresponds to the EOF bit of the Nth Transmit Buffer Descriptor. EOF = 1 indicates that the last buffer accessed by the 82586 during Transmit was the last Transmit Buffer in the data buffer chain associated with the Transmit Command.

BUF-ADR: Buffer Address. The BUF-PTR field in the DUMP-STATUS Command Block.

NXT-TB-AD-L: Next Transmit Buffer Address Low. Let N be the last Transmit Buffer in the transmit buffer chain of the TRANSMIT Command performed recently, then NXT-TB-AD-L are the two least significant bytes of the Nth buffer address.

LA-TB-ADR: Look Ahead Transmit Buffer Descriptor Address. Let N be the last Transmit Buffer in the transmit buffer chain of the TRANSMIT Command performed recently, then LA-TB-ADR is the NEXT-BD-ADDRESS field of the Nth Buffer Descriptor.

NXT-TBD-ADR: Next Transmit Buffer Descriptor Address. Similar in function to LA-TBD-ADR but related to Transmit Buffer Descriptor N-1. Actually, it is the address of Transmit Buffer Descriptor N.

Bytes 60H, 61H: This is a copy of the 2nd word in the DUMP-STATUS command presently executing.

NXT-CB-ADR: Next Command Block Address. The LINK-ADDRESS field in the DUMP Command Block presently executing. Points to the next command.

CUR-CB-ADR: Current Command Block Address. The address of the DUMP Command Block currently executing.

SCB-ADR: Offset of the System Control Block (SCB).

Bytes 7EH, 7FH:

RU-SUS-RQ (Bit 4) - Receive Unit Suspend Request.

Bytes 80H, 81H:

CU-SUS-RQ (Bit 4) - Command Unit Suspend Request.

END-OF-CBL (Bit 5) - End of Command Block List. If "1" indicates that DUMP-STATUS is the last command in the command chain.

ABRT-IN-PROG (Bit 6) - Command Unit Abort Request.

RU-SUS-FD (Bit 12) - Receive Unit Suspend Frame Descriptor Bit. Assume N is the Receive Frame Descriptor used recently, then RU-SUS-FD is equivalent to the S bit of N + 1 Receive Frame Descriptor.

Bytes 82H, 83H:

RU-SUS (Bit 4) - Receive Unit in SUSPENDED state.

RU-NRSRC (Bit 5) - Receive Unit in NO RESOURCES state.

RU-RDY (Bit 6) - Receive Unit in READY state.

RU-IDL (Bit 7) - Receive Unit in IDLE state.

RNR (Bit 12) - RNR Interrupt in Service bit.

CNA (Bit 13) - CNA Interrupt in Service bit.

FR (Bit 14) - FR Interrupt in Service bit.

CX (Bit 15) - CX Interrupt in Service bit.

Bytes 90H to 93H:

BUF-ADR-PTR - Buffer pointer is the absolute address of the bytes following the DUMP Command block.

Bytes 94H to 95H:

RCV-DMA-BC - Receive DMA Byte Count. This field contains number of bytes to be transferred during the next Receive DMA operation. The value depends on AL-LOCation configuration bit.

1. If AL-LOCation = 0 then RCV-DMA-BC = (2 times ADDR-LEN plus 2) if the next Receive Frame Descriptor has already been fetched.
2. If AL-LOCation = 1 then it contains the size of the next Receive Buffer.

BR+BUF-PTR+96H - Sum of Base Address plus BUF-PTR field and 96H.

RCV-DMA-ADR - Receive DMA absolute Address. This is the next RCV-DMA start address. The value depends on AL-LOCation configuration bit.

1. If AL-LOCation = 0, then RCV-DMA-ADR is the Destination Address field located in the next Receive Frame Descriptor.
2. If AL-LOCation = 1, then RCV-DMA-ADR is the next Receive Data Buffer Address.

The following nomenclature has been used in the DUMP table:

0	• The 82586 writes zero in this location.
1	• The 82586 writes one in this location.
X	• The 82586 writes zero or one in this location.
///	• The 82586 copies this location from the corresponding position in the memory structure.

DIAGNOSE

The DIAGNOSE Command triggers an internal self test procedure of backoff related registers and counters.

The DIAGNOSE command includes the following:

STATUS word (written by 82586):

C	(Bit 15)	• Command Completed
B	(Bit 14)	• Busy Executing Command
OK	(Bit 13)	• Error Free Completion
FAIL	(Bit 11)	• Indicates that the Self Test Procedured Failed

COMMAND word:

EL	(Bit 15)	• End of Command List
S	(Bit 14)	• Suspend After Completion
I	(Bit 13)	• Interrupt After Completion
CMD	(Bits 0-2)	• DIAGNOSE = 7

LINK OFFSET: Address of next Command Block.

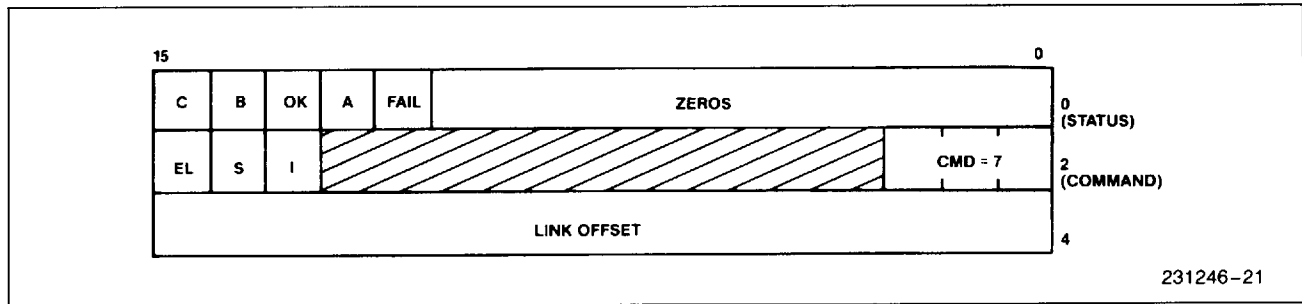

Figure 20. The DIAGNOSE Command Block

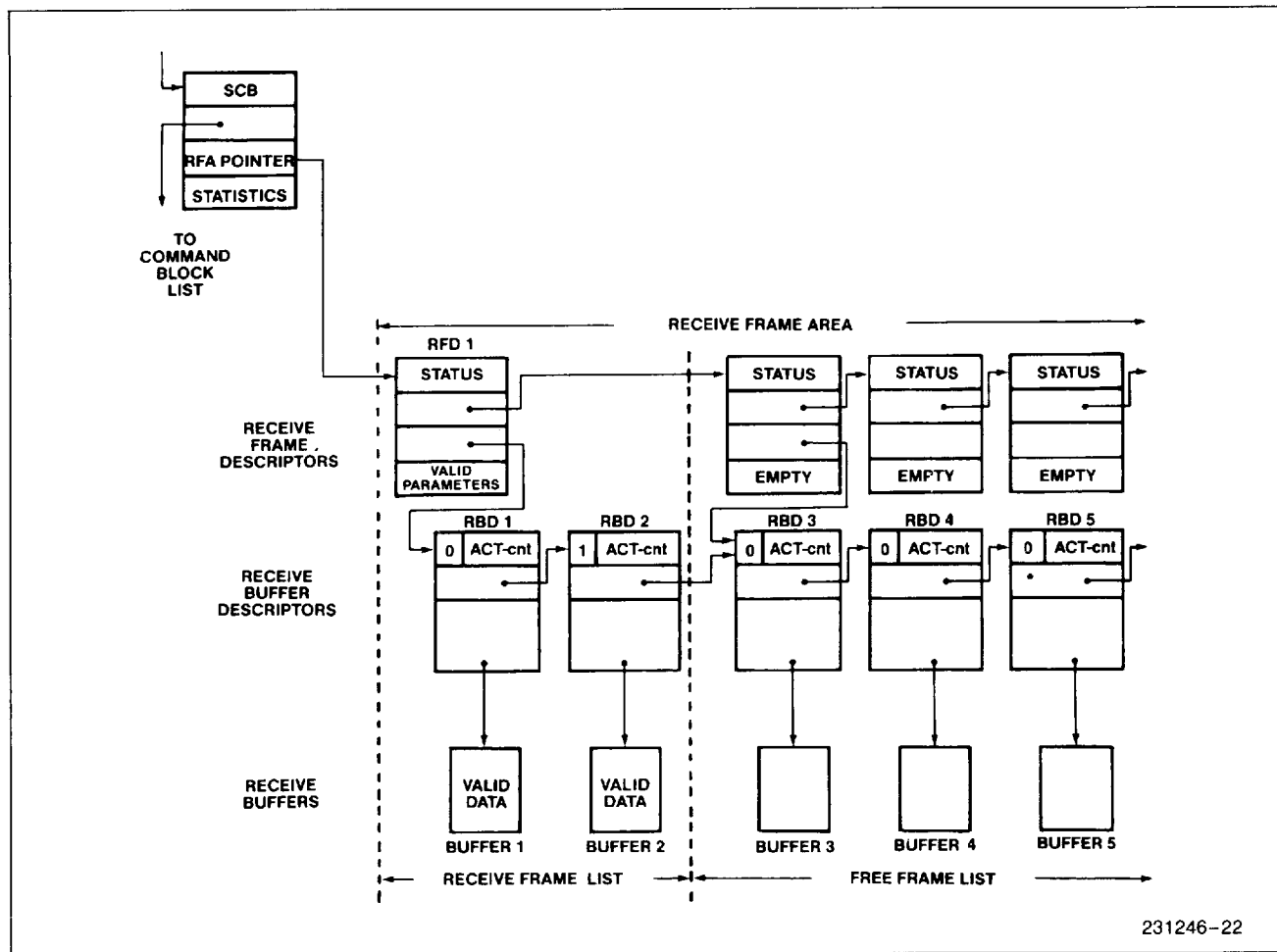

Figure 21. The Receive Frame Area

RECEIVE FRAME AREA (RFA)

The Receive Frame Area, RFA, is prepared by the host CPU, data is placed into the RFA by the 82586 as frames are received. RFA consists of a list of Receive Frame Descriptors (FD), each of which is associated with a frame. RFA-OFFSET field of SCB points to the first FD of the chain; the last FD is identified by the End-of-Listing flag (EL). See Figure 21.

FRAME DESCRIPTOR (FD) FORMAT

The FD includes the following fields:

STATUS word (set by the 82586):

C	(Bit 15)	• Completed Storing Frame.
B	(Bit 14)	• FD was Consumed by RU.

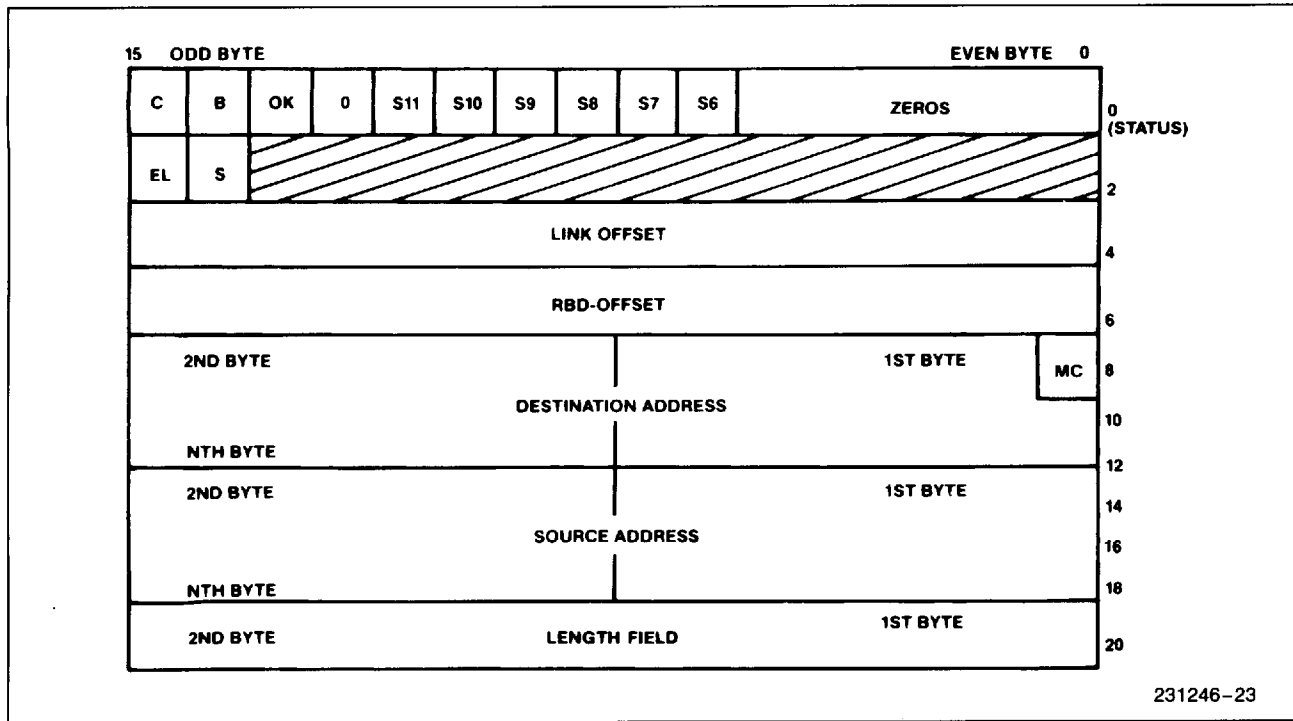

Figure 22. The Frame Descriptor (FD) Format

OK	(Bit 13)	<ul style="list-style-type: none"> • Frame received successfully. If this bit is set, then all others will be reset; if it is reset, then the other bits will indicate the nature of the error.
S11	(Bit 11)	<ul style="list-style-type: none"> • Received Frame Experienced CRC Error.
S10	(Bit 10)	<ul style="list-style-type: none"> • Received Frame Experienced an Alignment Error.
S9	(Bit 9)	<ul style="list-style-type: none"> • RU ran out of resources during reception of this frame.
S8	(Bit 8)	<ul style="list-style-type: none"> • RCV-DMA Overrun.
S7	(Bit 7)	<ul style="list-style-type: none"> • Received frame had fewer bits than configured Minimum Frame Length.
S6	(Bit 6)	<ul style="list-style-type: none"> • No EOF flag detected (only when configured to Bitstuffing).

COMMAND word:

EL	(Bit 15)	<ul style="list-style-type: none"> • Last FD in the List.
S	(Bit 14)	<ul style="list-style-type: none"> • RU should be suspended after receiving this frame.

LINK OFFSET: Address of next FD in list.

RBD-OFFSET: (initially prepared by the CPU and later may be updated by 82586): Address of the first RBD that represents the Information Field. RBD-OFFSET = 0FFFFH means there is no Information Field.

DESTINATION ADDRESS (written by 82586): Contains Destination Address of received frame. The length in bytes, it is determined by the Address Length configuration parameter.

SOURCE ADDRESS (written by 82586): Contains Source Address of received frame. Its length is the same as DESTINATION ADDRESS.

LENGTH FIELD (written by 82586): Contains the 2 byte Length or Type Field of received frame.

RECEIVE BUFFER DESCRIPTOR FORMAT

The Receive Buffer Descriptor (RBD) holds information about a buffer; size and location, and the means for forming a chain of RBDs, (forward pointer and end-of-frame indication).

The Buffer Descriptor contains the following fields.

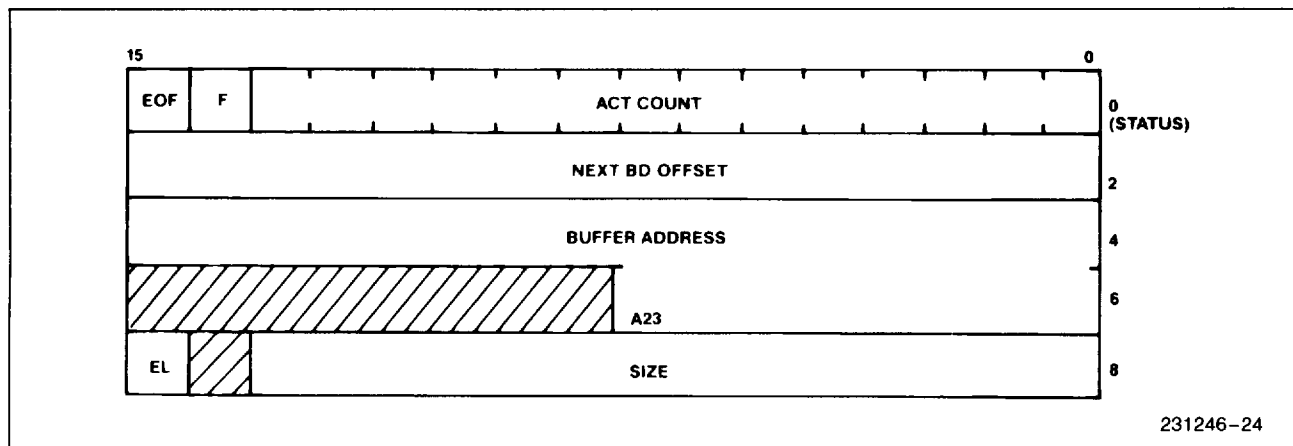

Figure 23. The Receive Buffer Descriptor (RBD) Format

STATUS word (written by the 82586).

EOF	(Bit 15)	• Last buffer in received frame.
F	(Bit 14)	• ACT COUNT field is valid.
ACT COUNT	(Bits 0-13)	• Number of bytes in the buffer that are actually occupied.

BUFFER ADDRESS: 24-bit absolute address of buffer.

EL/SIZE:

EL	(BIT 15)	• Last BD in list.
SIZE	(Bits 0-13)	• Number of bytes the buffer is capable of holding.

NEXT RBD OFFSET: Address of next BD in list of BD's.

82586

T-75-49

ABSOLUTE MAXIMUM RATINGS*

Ambient Temperature Under Bias 0°C to 70°C
 Storage Temperature -65°C to 150°C
 Voltage on Any Pin with
 Respect to Ground -1.0V to +7V
 Power Dissipation 3.0 Watts

**Notice: Stresses above those listed under "Absolute Maximum Ratings" may cause permanent damage to the device. This is a stress rating only and functional operation of the device at these or any other conditions above those indicated in the operational sections of this specification is not implied. Exposure to absolute maximum rating conditions for extended periods may affect device reliability.*

D.C. CHARACTERISTICS

$T_A = 0^\circ\text{C}$ to 70°C , $T_C = 0^\circ\text{C}$ to 105°C , $V_{CC} = 5\text{V} \pm 10\%$, CLK has MOS levels (See V_{MIL} , V_{MIH} , V_{MOL} , V_{MOH}). $\overline{\text{TxC}}$ and $\overline{\text{RxC}}$ have 82C501 compatible levels (V_{MIL} , V_{TIH} , V_{RIH}). All other signals have TTL levels (see V_{IL} , V_{IH} , V_{OL} , V_{OH}).

Symbol	Parameter	Min	Max	Units	Test Conditions
V_{IL}	Input Low Voltage (TTL)	-0.5	+0.8	V	
V_{IH}	Input High Voltage (TTL)	2.0	$V_{CC} + 0.5$	V	
V_{OL}	Output Low Voltage (TTL)		0.45	V	$I_{OL} = 2.5\text{ mA}$
V_{OH}	Output High Voltage (TTL)	2.4		V	$I_{OH} = 400\ \mu\text{A}$
V_{MIL}	Input Low Voltage (MOS)	-0.5	0.6	V	
V_{MIH}	Input High Voltage (MOS)	3.9	$V_{CC} + 0.5$	V	
V_{TIH}	Input High Voltage ($\overline{\text{TxC}}$)	3.3	$V_{CC} + 0.5$	V	
V_{RIH}	Input High Voltage ($\overline{\text{RxC}}$)	3.0	$V_{CC} + 0.5$	V	
V_{MOL}	Output Low Voltage (MOS)		0.45	V	$I_{OL} = 2.5\text{ mA}$
V_{MOH}	Output High Voltage (MOS)	$V_{CC} - 0.5$		V	$I_{OH} = 400\ \mu\text{A}$
I_{LI}	Input Leakage Current		± 10	μA	$0 \leq V_{IN} \leq V_{CC}$
I_{LO}	Output Leakage Current		± 10	μA	$0.45 \leq V_{OUT} \leq V_{CC}$
C_{IN}	Capacitance of Input Buffer		10	pF	FC = 1 MHz
C_{OUT}	Capacitance of Output Buffer		20	pF	FC = 1 MHz
I_{CC}	Power Supply Current		550 450	mA	$T_A = 0^\circ\text{C}$ $T_A = 70^\circ\text{C}$

SYSTEM INTERFACE A.C. TIMING CHARACTERISTICS

$T_A = 0^\circ\text{C}$ to 70°C , $T_C = 0^\circ\text{C}$ to 105°C , $V_{CC} = 5V \pm 10\%$. Figures 24 and 25 define how the measurements should be done.

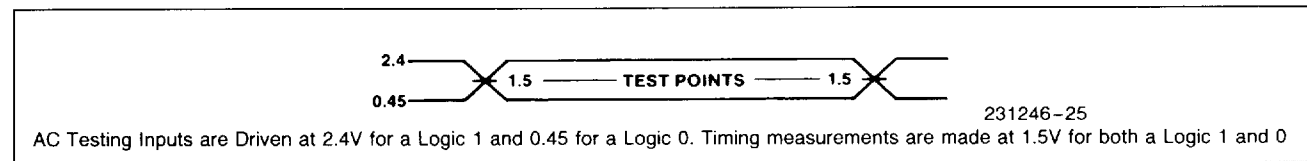
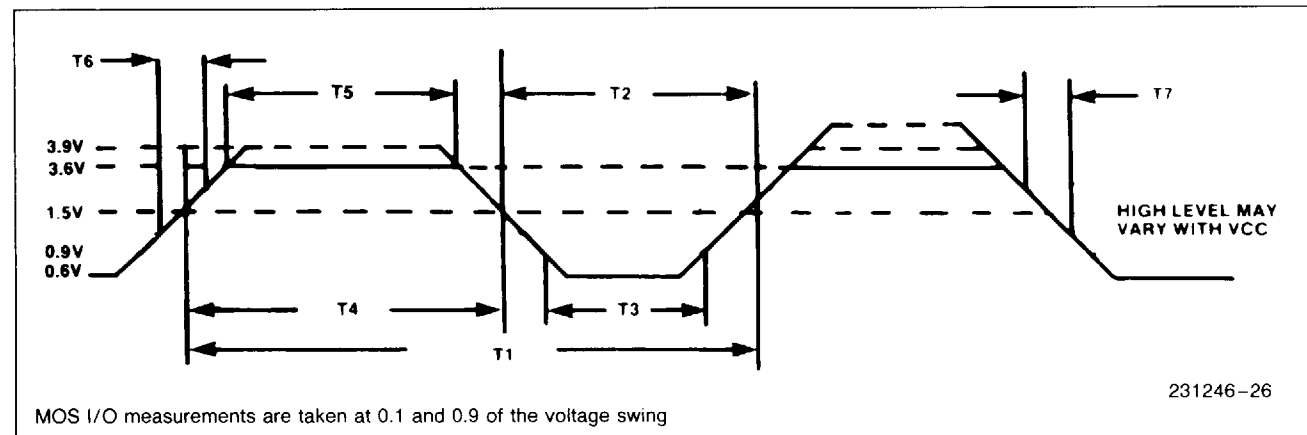
INPUT AND OUTPUT WAVEFORMS FOR A.C. TESTS**Figure 24. TTL Input/Output Voltage Levels for Timing Measurements****Figure 25. System Clock CMOS Input Voltage Levels for Timing Measurements.**

INPUT TIMING REQUIREMENTS*

Symbol	Parameter	82586-6 (6 MHz)		82586 (8 MHz)		82586-10 (10 MHz)		Comments
		Min	Max	Min	Max	Min	Max	
T1	CLK Cycle Period	166	2000	125	2000	100	200	
T2	CLK Low Time at 1.5V	73	1000	55	1000	44	1000	
T3	CLK Low Time at 0.9V			42.5	1000	42.5	1000	
T4	CLK High Time at 1.5V	73		55		44		
T5	CLK High Time at 3.6V			42.5		42.5		
T6	CLK Rise Time		15		15		12	Note 1
T7	CLK Fall Time		15		15		12	Note 2
T8	Data in Setup Time	20		20		15		
T9	Data in Hold Time	10		10		10		
T10	Async RDY Active Setup Time	20		20		15		Note 3
T11	Async RDY Inactive Setup Time	35		35		25		Note 3
T12	Async RDY Hold Time	15		15		15		Note 3
T13	Synchronous Ready/Active Setup	35		35		35		
T14	Synchronous Ready Hold Time	0		0		0		
T15	HLDA Setup Time	20		20		20		Note 3
T16	HLDA Hold Time	10		10		5		Note 3
T17	Reset Setup Time	20		20		20		Note 3
T18	Reset Hold Time	10		10		10		Note 3
T19	CA Pulse Width	1 T1		1 T1		1 T1		
T20	CA Setup Time	20		20		20		Note 3
T21	CA Hold Time	10		10		10		Note 3

OUTPUT TIMINGS**

Symbol	Parameter	Min	Max	Min	Max	Min	Max	Comments
T22	DT/R Valid Delay	0	60	0	60	0	44	
T23	\overline{WR} , \overline{DEN} Active Delay	0	70	0	70	0	56	
T24	\overline{WR} , \overline{DEN} Inactive Delay	10	65	10	65	10	45	
T25	Int. Active Delay	0	85	0	85	0	70	Note 4
T26	Int. Inactive Delay	0	85	0	85	0	70	Note 4
T27	Hold Active Delay	0	85	0	85	0	70	Note 4
T28	Hold Inactive Delay	0	85	0	85	0	70	Note 4
T29	Address Valid Delay	0	55	0	55	0	50	
T30	Address Float Delay	0	50	0	50	12	50	
T31	Data Valid Delay	0	55	0	55	0	50	Note 7
T32	Data Hold Time	0		0		0		
T33	Status Active Delay	10	60	10	60	10	45	

OUTPUT TIMINGS** (Continued)

Symbol	Parameter	82582-6 (6 MHz)		82586 (8 MHz)		82586-10 (10 MHz)		Comments
		Min	Max	Min	Max	Min	Max	
T34	Status Inactive Delay	10	70	10	70	10	50	Note 8
T35	ALE Active Delay	0	45	0	45	0	35	Note 5
T36	ALE Inactive Delay	0	45	0	45	0	37	Note 5
T37	ALE Width	T2-10		T2-10		T2-10		Note 5
T38	Address Valid to ALE Low	T2-40		T2-30		T2-25		
T39	Address Hold to ALE Inactive	T4-10		T4-10		T4-10		
T40	\overline{RD} Active Delay	10	95	10	95	10	95	
T41	\overline{RD} Inactive Delay	10	70	10	70	10	70	
T42	\overline{RD} Width	2T1-50		2T1-50		2T1-46		
T43	Address Float to \overline{RD} Active	10		10		0		
T44	\overline{RD} Inactive to Address Active	T1-40		T1-40		T1-34		
T45	\overline{WR} Width	2T1-40		2T1-40		2T1-34		
T46	Data Hold After \overline{WR}	T2-25		T2-25		T2-25		
T47	Control Inactive After Reset	0	60	0	60	0	60	Note 6

*All units are in ns.

**CL on all outputs is 20-200 pF unless otherwise specified.

NOTES:

1. 1.0V to 3.5V
2. 3.5V to 1.0V
3. To guarantee recognition at next clock
4. CL = 50 pF
5. CL = 100 pF

6. Affects:

MIN MODE: \overline{RD} , \overline{WR} , DT/ \overline{R} , \overline{DEN}
 MAX MODE: $\overline{S0}$, $\overline{S1}$

7. High address lines (A16-A24, BHE) become valid one clock before T1 only on first memory cycle after the 82586 acquired the bus.
8. $\overline{S1}$, $\overline{S0}$ go inactive just prior to T4.

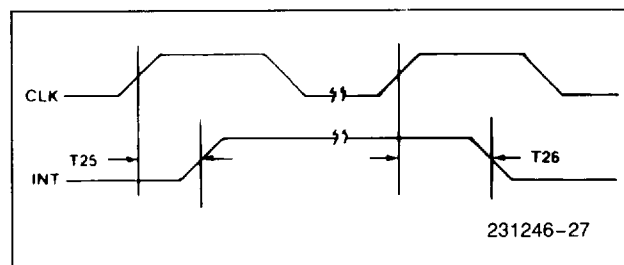

Figure 26. INT Output Timing

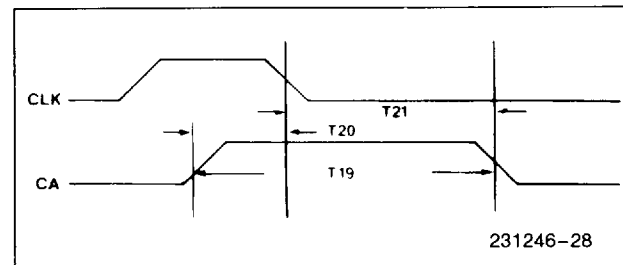

Figure 27. CA Input Timing

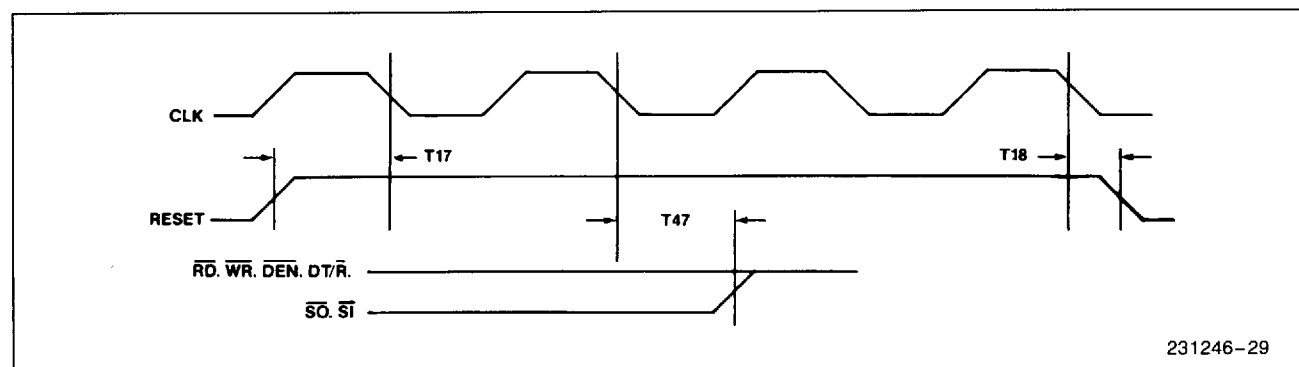
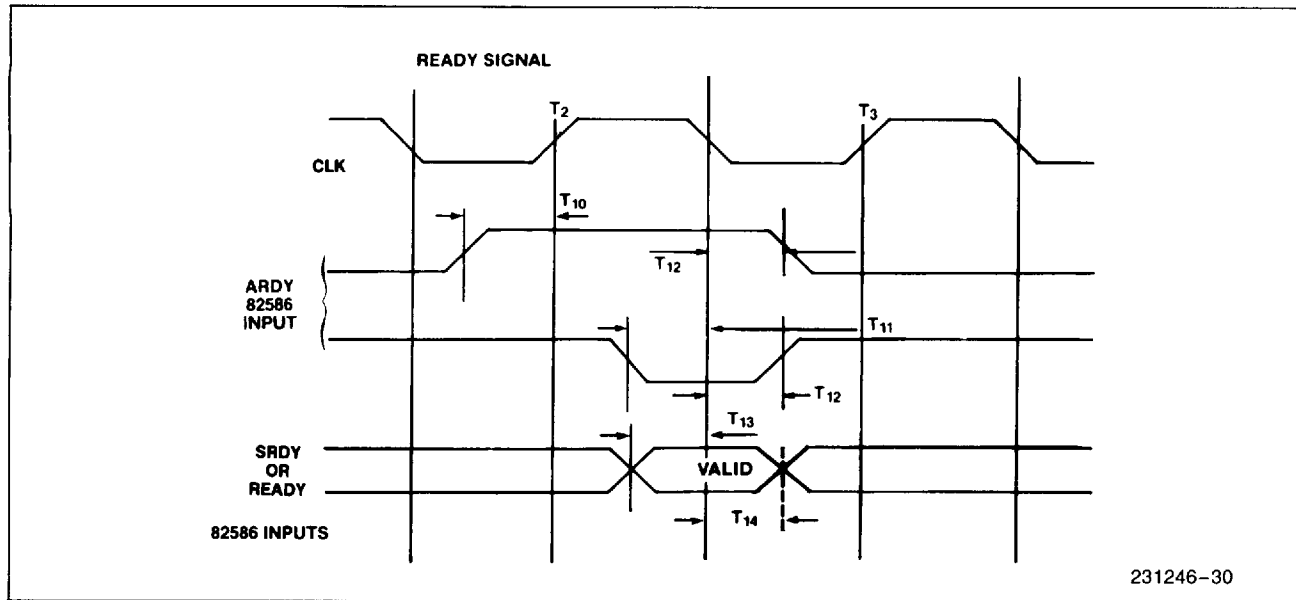
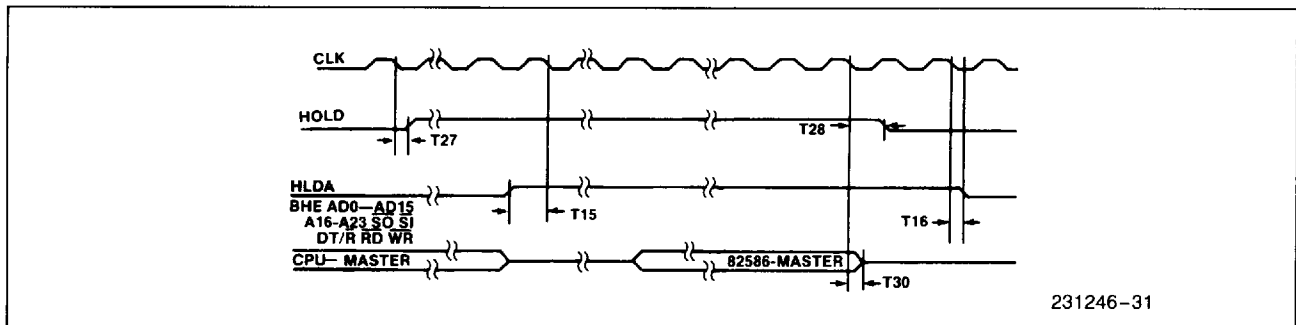

Figure 28. RESET Timing



231246-30

Figure 29. ARDY and SRDY Timings Relative to CLK



231246-31

Figure 30. HOLD/HLDA Timing Relative to CLK

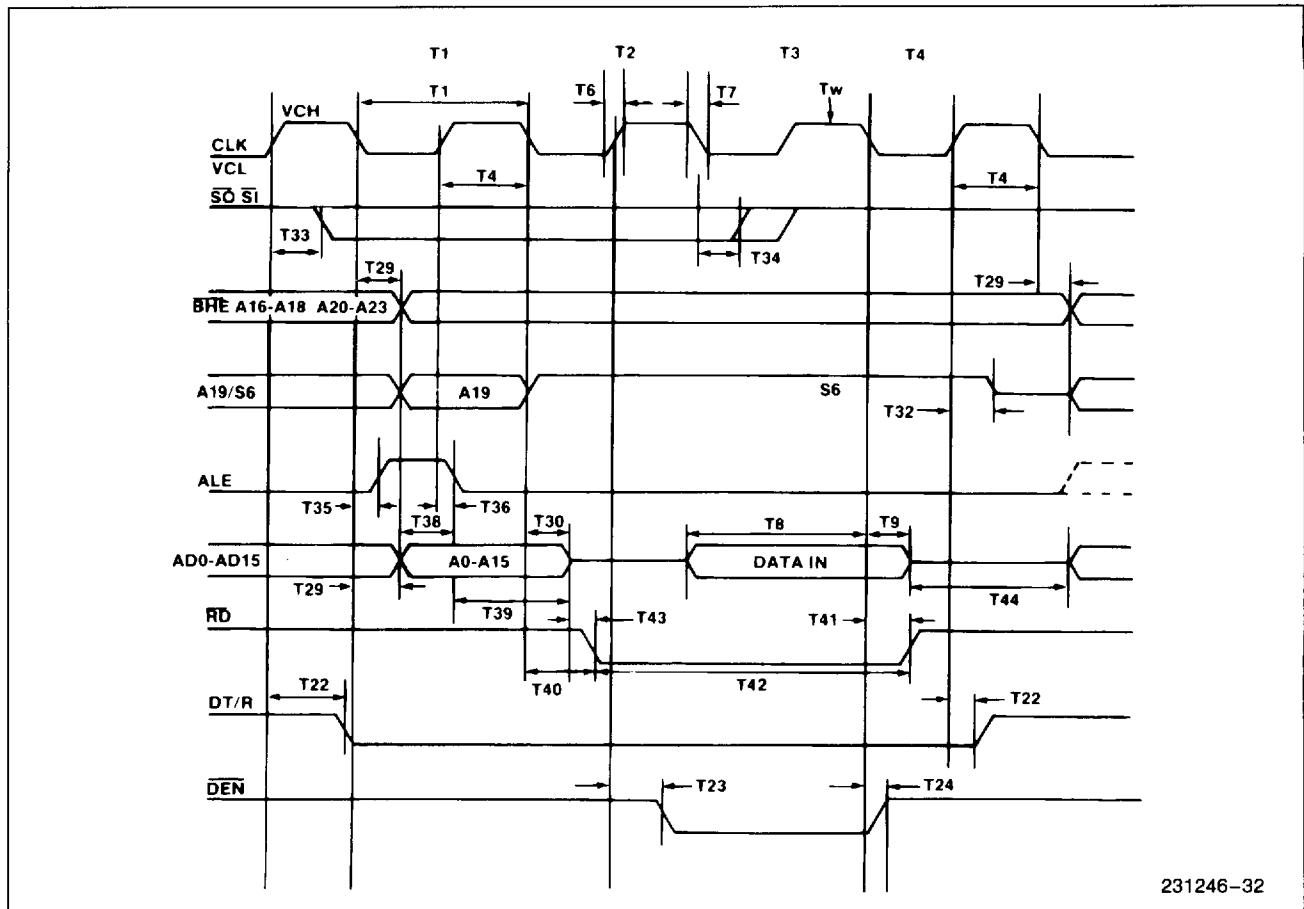

231246-32

Figure 31. Read Cycle Timing

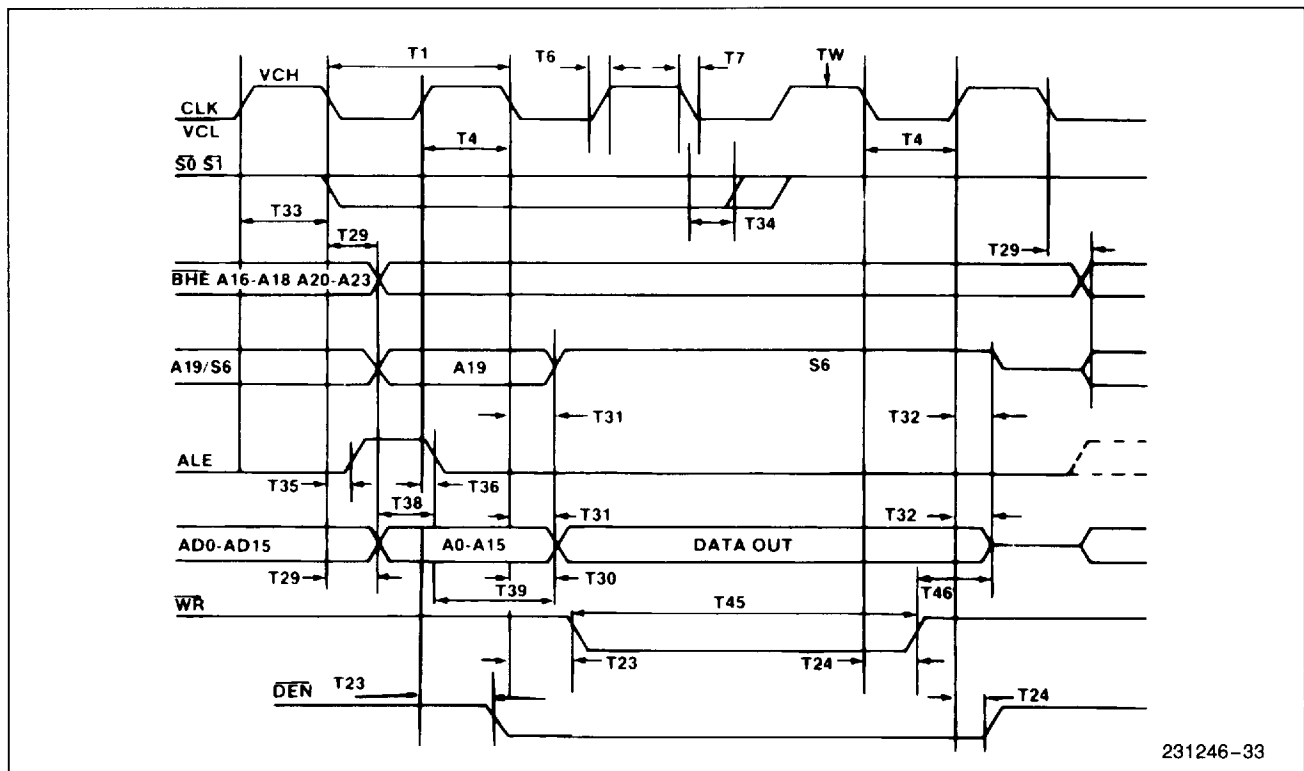

231246-33

Figure 32. Write Cycle Timing

82586

T-75-49

SERIAL INTERFACE A.C. TIMING CHARACTERISTICS**CLOCK SPECIFICATION**Applies for $\overline{\text{Tx}}\overline{\text{C}}$, $\overline{\text{Rx}}\overline{\text{C}}$ for NRZ:

$$f_{\text{min}} = 100 \text{ kHz} \pm 100 \text{ ppm}$$

$$f_{\text{max}} = 10 \text{ MHz} \pm 100 \text{ ppm}$$

for Manchester:

$$f_{\text{min}} = 500 \text{ kHz} \pm 100 \text{ ppm}$$

$$f_{\text{max}} = 10 \text{ MHz} \pm 100 \text{ ppm}$$

for Manchester, symmetry is needed:

$$T_{51}, T_{52} = \frac{1}{2f} \pm 5\%$$

A.C. CHARACTERISTICS**TRANSMIT AND RECEIVE TIMING PARAMETER SPECIFICATION***

Symbol	Parameter	Min	Max	Comments
TRANSMIT CLOCK PARAMETERS				
T48	$\overline{\text{Tx}}\overline{\text{C}}$ Cycle	100	1000	Notes 14, 2
T48	$\overline{\text{Tx}}\overline{\text{C}}$ Cycle	100		Notes 14, 3
T49	$\overline{\text{Tx}}\overline{\text{C}}$ Rise Time		5	Note 14
T50	$\overline{\text{Tx}}\overline{\text{C}}$ Fall Time		5	Note 14
T51	$\overline{\text{Tx}}\overline{\text{C}}$ High Time @ 3.0V	40	1000	Note 14
T52	$\overline{\text{Tx}}\overline{\text{C}}$ Low Time @0.9V	40		Notes 14, 4
TRANSMIT DATA PARAMETERS				
T53	TxD Rise Time		10	Notes 5, 13
T54	TxD Fall Time		10	Notes 5, 13
T55	TxD Transition-Transition	Min (T51, T52) - 7		Notes 2, 5
T56	$\overline{\text{Tx}}\overline{\text{C}}$ Low to TxD Valid		40	Notes 3, 5
T57	$\overline{\text{Tx}}\overline{\text{C}}$ Low to TxD Transition		40	Notes 2, 5
T58	$\overline{\text{Tx}}\overline{\text{C}}$ High to TxD Transition		40	Notes 2, 5
T59	$\overline{\text{Tx}}\overline{\text{C}}$ Low to TxD High at the Transmission End		40	Note 5
REQUEST TO SEND/CLEAR TO SEND PARAMETERS				
T60	$\overline{\text{Tx}}\overline{\text{C}}$ Low to $\overline{\text{RTS}}$ Low. Time to Activate $\overline{\text{RTS}}$		40	Note 6
T61	$\overline{\text{CTS}}$ Valid to $\overline{\text{Tx}}\overline{\text{C}}$ Low. $\overline{\text{CTS}}$ Setup Time	45		
T62	$\overline{\text{Tx}}\overline{\text{C}}$ Low to $\overline{\text{CTS}}$ Invalid. $\overline{\text{CTS}}$ Hold Time	20		Note 7
T63	$\overline{\text{Tx}}\overline{\text{C}}$ Low to $\overline{\text{RTS}}$ High, time to Deactivate $\overline{\text{RTS}}$		40	Note 6
RECEIVE CLOCK PARAMETERS				
T64	$\overline{\text{Rx}}\overline{\text{C}}$ Clock Cycle	100		Notes 15, 3
T65	$\overline{\text{Rx}}\overline{\text{C}}$ Rise Time		5	Note 15
T66	$\overline{\text{Rx}}\overline{\text{C}}$ Fall Time		5	Note 15
T67	$\overline{\text{Rx}}\overline{\text{C}}$ High Time @ 2.7V	36	1000	Note 15
T68	$\overline{\text{Rx}}\overline{\text{C}}$ Low Time @0.9V	40		Note 15

*All units are in ns.

A.C. CHARACTERISTICS (Continued)**TRANSMIT AND RECEIVE TIMING PARAMETER SPECIFICATION*** (Continued)

Symbol	Parameter	Min	Max	Comments
RECEIVE DATA PARAMETERS				
T69	RxD Setup Time	30		Note 1
T70	RxD Hold Time	30		Note 1
T71	RxD Rise Time		10	Note 1
T72	RxD Fall Time		10	Note 1
CARRIER SENSE/COLLISION DETECT PARAMETERS				
T73	\overline{CDT} Valid to \overline{TxC} High Ext. Collision Detect Setup Time	30		Note 12
T74	\overline{TxC} High to \overline{CDT} Inactive. \overline{CDT} Hold Time	20		Note 12
T75	\overline{CDT} Low to Jamming Start			Note 8
T76	\overline{CRS} Valid to \overline{TxC} High Ext. Carrier Sense Setup Time	30		Note 12
T77	\overline{TxC} High to \overline{CRS} Inactive. \overline{CRS} Hold Time	20		Note 12
T78	\overline{CRS} Low to Jamming Start			Note 9
T79	Jamming Period			Note 10
T80	\overline{CRS} Inactive Setup Time to \overline{RxC} High End of Receive Frame	60		
T81	\overline{CRS} Active Hold Time from \overline{RxC} High	3		
INTERFRAME SPACING PARAMETER				
T82	Inter Frame Delay			Note 11

*All units are in ns.

NOTES:

1. TTL levels
2. Manchester only
3. NRZ only
4. Manchester requires 50% duty cycle
5. 1 TTL load + 50 pF
6. 1 TTL load + 100 pF
7. Abnormal end of transmission. \overline{CTS} expires before \overline{RTS}
8. Programmable value:
 $T75 = NCDF \times T48 + (12.5 \text{ to } 23.5) \times T48$ if collision occurs after preamble
NCDF—The collision detection filter configuration value
9. Programmable value:
 $T78 = NCSF \times T48 + (12.5 \text{ to } 23.5) \times T48$
NCSF—The carrier sense filter configuration value
TBD is a function of internal/external carrier sense bit
10. $T79 = 32 \times T48$
11. Programmable value:
 $T82 = NIFS \times T48$
NIFS—the IFS configuration value
- *12. To guarantee recognition on the next clock
13. Applies to TTL levels
14. 82C501 compatible levels, see Figure 34
15. 82C501 compatible levels, see Figure 35

A.C. TIMING CHARACTERISTICS

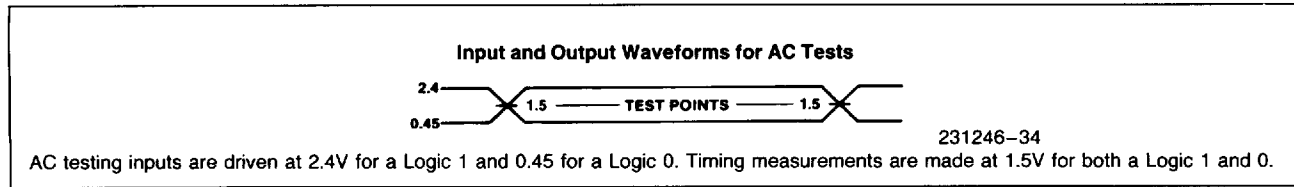

Figure 33. TTL Input/Output Voltage Levels for Timing Measurements

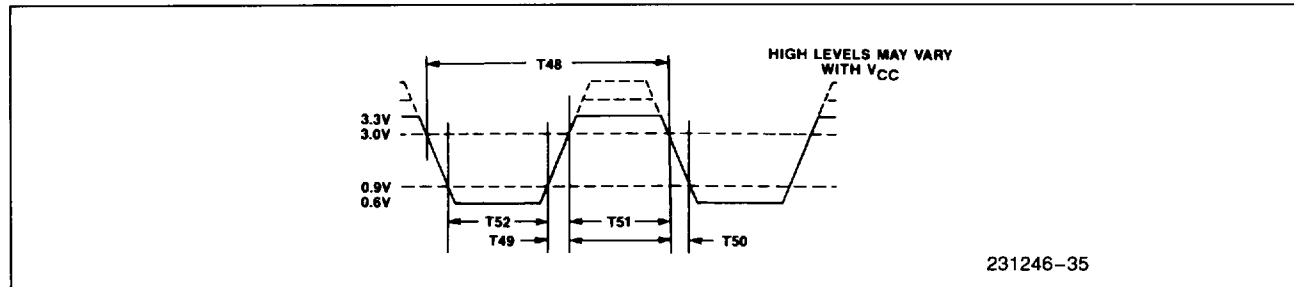

Figure 34. $\overline{\text{TxC}}$ Input Voltage Levels for Timing Measurements

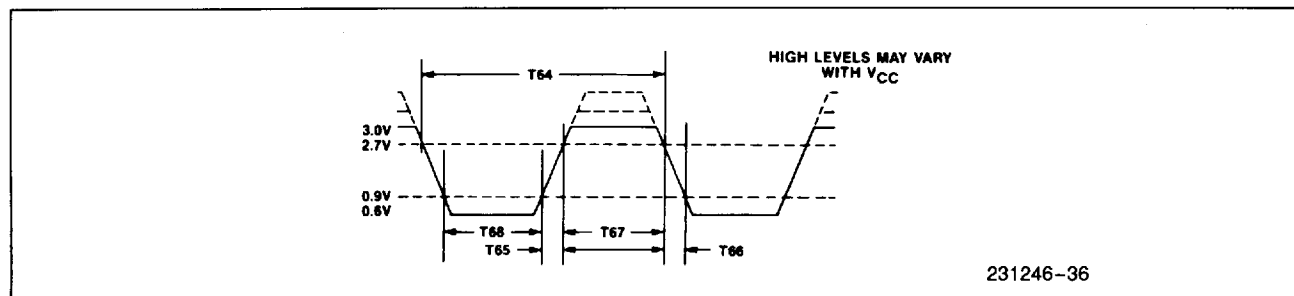

Figure 35. $\overline{\text{RxC}}$ Input Voltage Levels for Timing Measurements

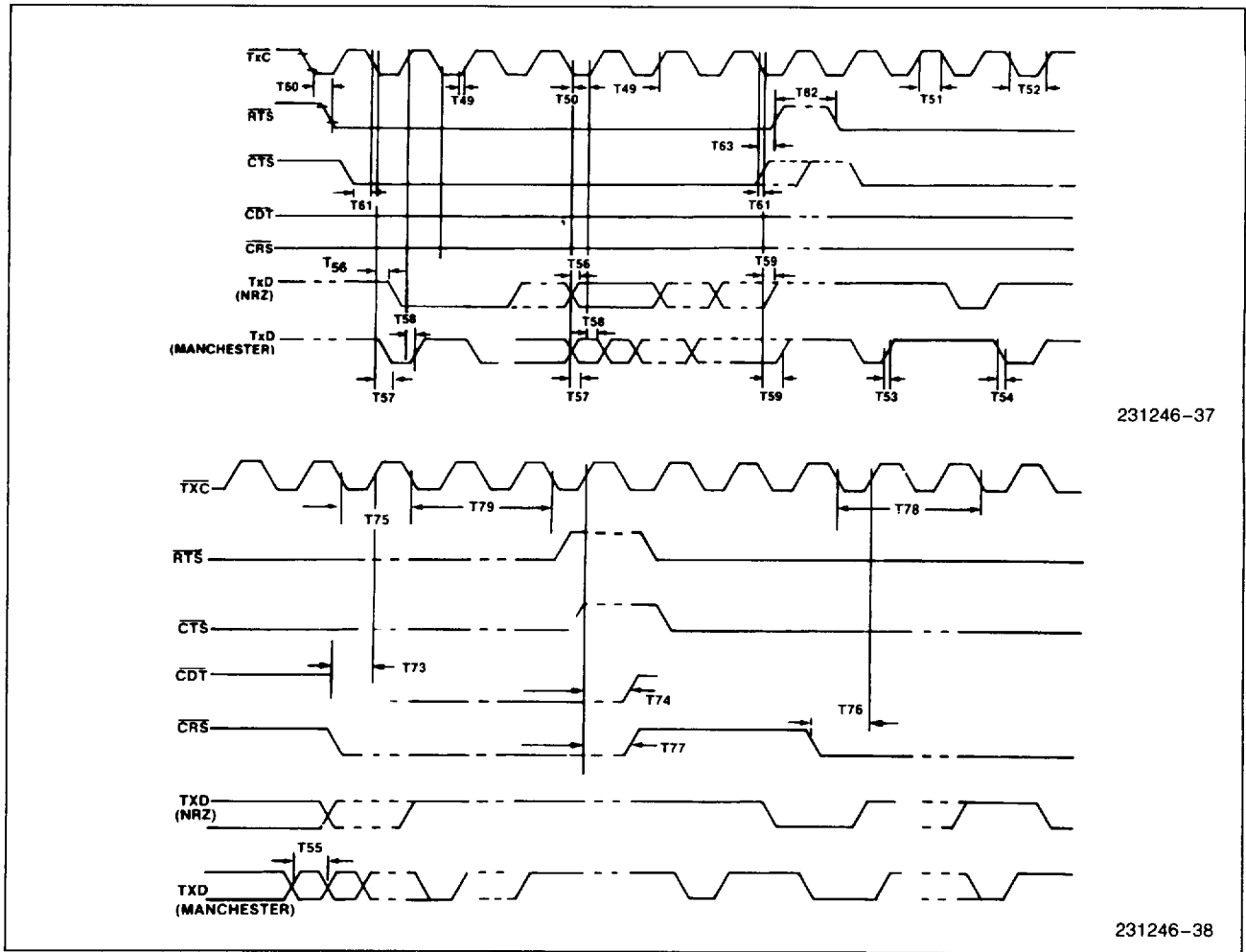

Figure 36. Transmit and Control and Data Timing

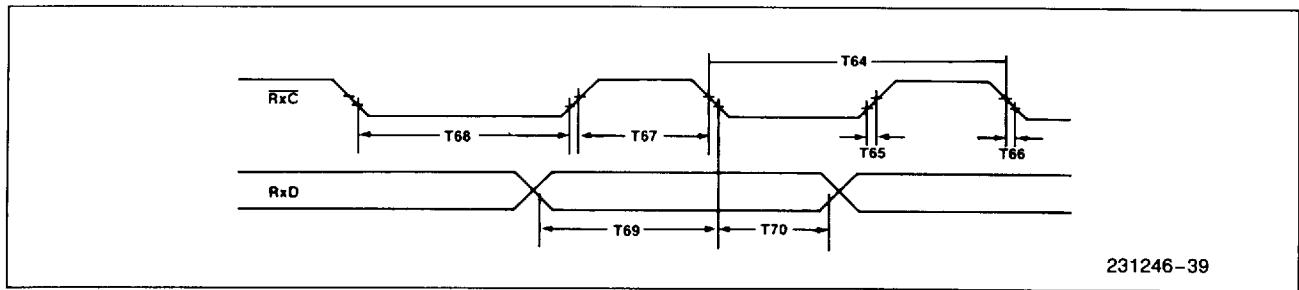

Figure 37. RxD Timing Relative to RxC

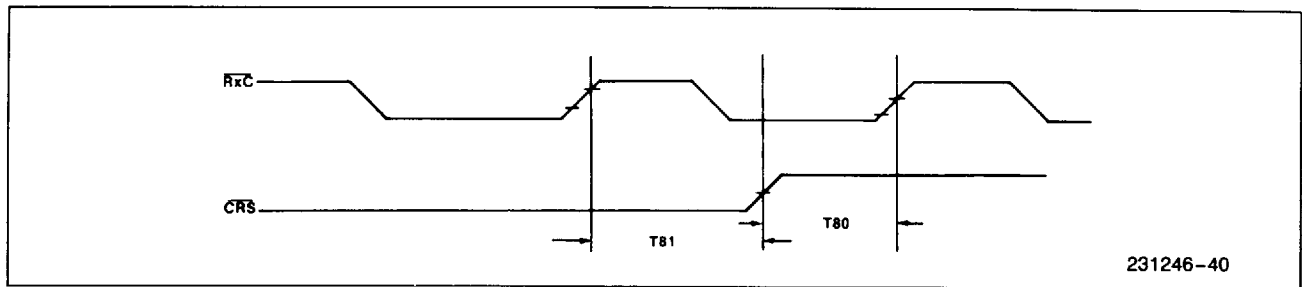

Figure 38. CRS Timing Relative to RxC