

1. PART NO. EXPRESSION :

SCI1008HQ-3N0JF

(a) (b) (c) (d) (e)(f)

(a) Series code

(b) Dimension code

(c) Type code : HQ (High Q factor)

(d) Inductance code : 3N0 = 3.0nH

(e) Tolerance code : G = ±2%, J = ±5%, K = ±10%

(f) F : RoHS Compliant

2. CONFIGURATION & DIMENSIONS :

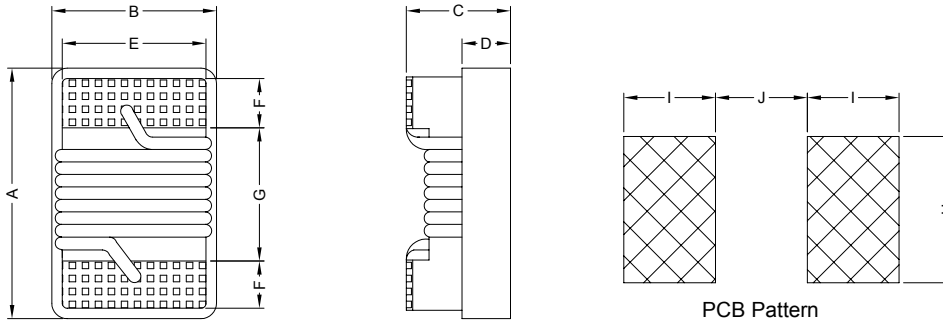

Unit:m/m

A	B	C	D	E	F	G	H	I	J
2.92 Max.	2.79 Max.	2.03 Max.	0.65 Ref.	2.03 Ref.	0.51 Ref.	1.52 Ref.	2.54 Ref.	1.02 Ref.	1.27 Ref.

3. SCHEMATIC :

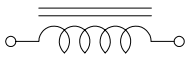

4. MATERIALS :

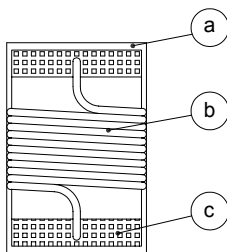

(a) Core : Ceramic U core

(b) Wire : Enamelled Copper Wire

(c) Terminal Metallization : Ag + Ni + Au



RoHS Compliant

NOTE : Specifications subject to change without notice. Please check our website for latest information.

22.06.2010



SUPERWORLD ELECTRONICS (S) PTE LTD

5. GENERAL SPECIFICATION :

- a) Storage temp. : -25°C to +80°C
- b) Operating temp. : -40°C to +125°C
- c) Temperature rise : 40°C Max.
- d) Rated current : Base on temp. rise & $\Delta L/L0A=10\%$ Max.
- e) Resistance to solder heat : 260°C.10sec

6. ELECTRICAL CHARACTERISTICS :

Part No.	Tolerance Available	L (nH)	Test Freq (MHz)	Q Min.	Q Test Freq (MHz)	SRF (MHz) Min.	DCR (Ω) Max.	IDC (mA) Max.
SCI1008HQ-3N0□F	K, J	3.0	50	70	1500	6000	0.040	1600
SCI1008HQ-4N1□F	K, J	4.1	50	75	1500	6000	0.050	1600
SCI1008HQ-7N8□F	K, J	7.8	50	75	500	3800	0.050	1600
SCI1008HQ-10N□F	K, J, G	10	50	60	500	3600	0.060	1600
SCI1008HQ-12N□F	K, J, G	12	50	70	500	2800	0.060	1500
SCI1008HQ-18N□F	K, J, G	18	50	62	350	2700	0.070	1400
SCI1008HQ-22N□F	K, J, G	22	50	62	350	2050	0.070	1400
SCI1008HQ-33N□F	K, J, G	33	50	75	350	1700	0.090	1300
SCI1008HQ-39N□F	K, J, G	39	50	75	350	1300	0.090	1300
SCI1008HQ-47N□F	K, J, G	47	50	75	350	1450	0.120	1200
SCI1008HQ-56N□F	K, J, G	56	50	75	350	1230	0.120	1200
SCI1008HQ-68N□F	K, J, G	68	50	80	350	1150	0.130	1100
SCI1008HQ-82N□F	K, J, G	82	50	80	350	1060	0.160	1100
SCI1008HQ-R10□F	K, J, G	100	50	62	350	820	0.160	1000

Inductance tolerance :

- : G : $\pm 2\%$
- J : $\pm 5\%$
- K : $\pm 10\%$



RoHS Compliant

NOTE : Specifications subject to change without notice. Please check our website for latest information.

22.06.2010



SUPERWORLD ELECTRONICS (S) PTE LTD

7. PACKAGING INFORMATION :

Reel Configuration :

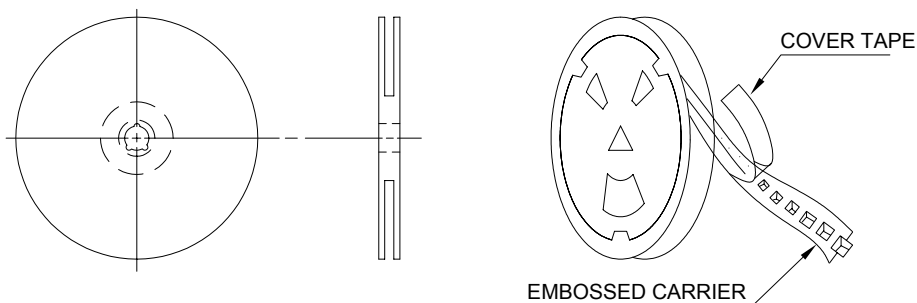

Paper Tape :

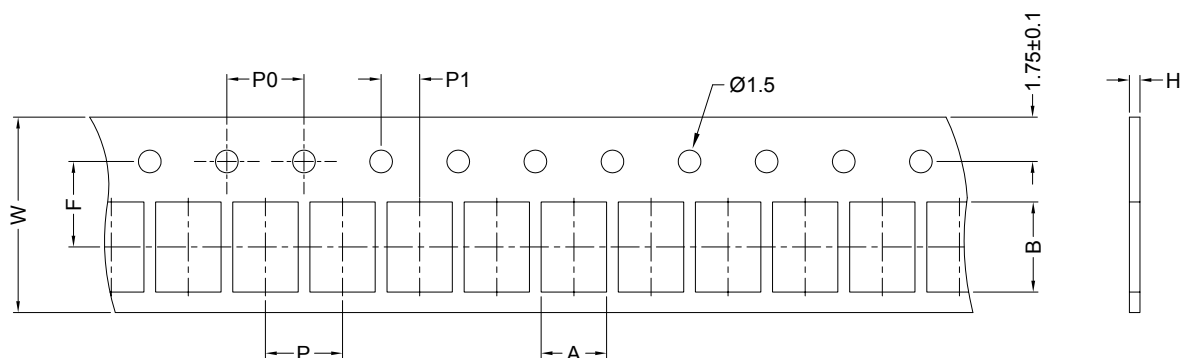

Dimension (unit: mm)

Series	A	B	H	F	P	P0	P1	W	Qty
SCI0402S	0.72	1.19	0.60	3.50	4.00	4.00	2.00	8.00	4000pcs / reel
SCI0603S	1.35	1.95	0.95	3.50	4.00	4.00	2.00	8.00	4000pcs / reel



RoHS Compliant

NOTE : Specifications subject to change without notice. Please check our website for latest information.

22.06.2010



SUPERWORLD ELECTRONICS (S) PTE LTD

Embossed Carrier Tape :

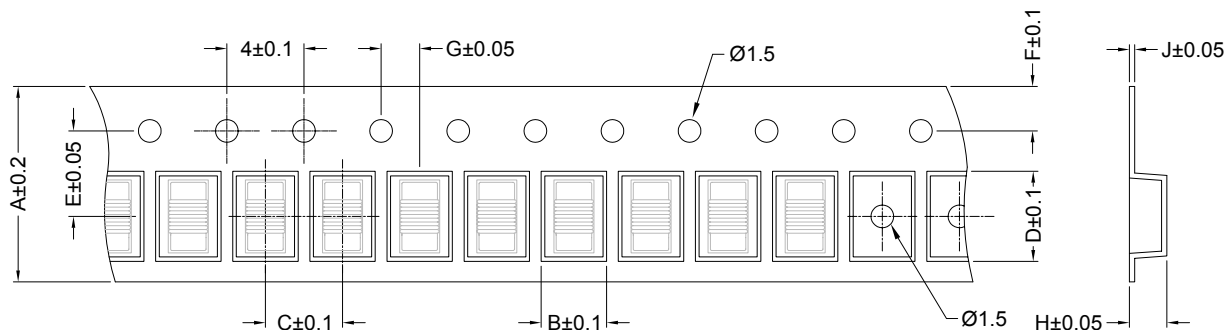

Dimension (unit: mm)

Series	A	B	C	D	E	F	G	H	J	Qty
SCI0805S	8	1.85	4	2.30	3.5	1.75	2	1.45	0.23	2000pcs / reel
SCI0805LP	8	1.80	4	2.30	3.5	1.75	2	0.90	0.23	2000pcs / reel
SCI0805HQ	8	1.85	4	2.30	3.5	1.75	2	1.45	0.23	2000pcs / reel
SCI1008S	8	2.70	4	2.80	3.5	1.75	2	2.00	0.23	2000pcs / reel
SCI1008LP	8	2.70	4	2.80	3.5	1.75	2	1.50	0.23	2000pcs / reel
SCI1008HQ	8	2.70	4	2.80	3.5	1.75	2	2.00	0.23	2000pcs / reel

Leader/Trailer Tape :

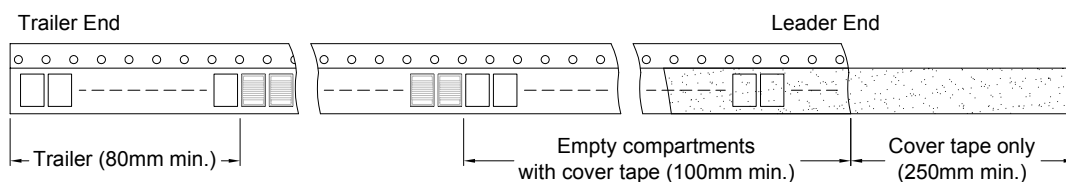

Peel-off Force :

Peel-off force should be in the range of 0.1N~0.7N at a peel-off speed of 300±10mm/min.

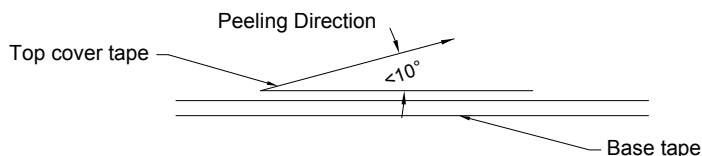

RoHS Compliant

NOTE : Specifications subject to change without notice. Please check our website for latest information.

22.06.2010



SUPERWORLD ELECTRONICS (S) PTE LTD

PG. 4

8. ENVIRONMENTAL CHARACTERISTICS :

Electrical Performance Test :

ITEM		SPECIFICATION	TEST CONDITIONS / TEST METHODS
1	Inductance	Refer to Electrical Characteristics List	HP4291B
2	Q		HP4291B
3	SRF		HP8753D
4	DC Resistance Rdc		Mico-Ohmmeter (GOM-801G)
5	Rated Current IDC		The device should be REFLOW soldered (230±5°C for 10 seconds) to a tinned copper subs rate. A dynamiter
6	Over Load Test	After test, inductors shall have no evidence of electrical and mechanical damage	Applied 2 times of rated allowed DC current to inductor for a period of 5 minute.
7	Withstanding Voltage Test	After test, inductors shall have no evidence of electrical and mechanical damage	AC voltage of 500VAC applied between inductors terminal and case for 1 minute.
8	Insulation Resistance Test	1000 MOhm min.	100VDC applied between inductor terminal and case



RoHS Compliant

NOTE : Specifications subject to change without notice. Please check our website for latest information.

22.06.2010



SUPERWORLD ELECTRONICS (S) PTE LTD

Mechanical Performance Test :

ITEM		SPECIFICATION	TEST CONDITIONS / TEST METHODS
1	Vibration	Appearance : No damage L change : within $\pm 5\%$ Q change : within $\pm 10\%$	Test device shall be soldered on the substrate Oscillation Frequency : 10 to 55 to 10Hz for 1 min. Amplitude : 1.5mm Time : 2hrs for each axis (X, Y, Z), total 6hrs.
2	Resistance to Soldering Heat	Appearance : No damage L change : within $\pm 5\%$ Q change : within $\pm 10\%$	Pre-heating : 150°C, 1 min Solder Composition : Sn/Pb=63/67 Solder Temperature : 230 \pm 5°C Immersion Time : 20 \pm 2sec Solder Temperature : 260 \pm 5°C Immersion Time : 5 \pm 2sec
3	Component Adhesion (Push Test)	1 lbs. For 0402 2 lbs. For 0603 3 lbs. For the rest	The device should be REFLOW soldered (230 \pm 5°C for 10 seconds) to a tinned copper subs rate. A dynamiter force gauge should be applied to the side of the component. The device must withstand a minimum force of 2 or 4 pounds without a failure of the termination attached to component.
3	Component Adhesion (Push Test)	The electrodes shall be at least 90% covered with new solder coating.	Pre-heating : 150°C, 1min Solder Composition : Sn/Pb=63/67 Solder Temperature : 230 \pm 5°C Immersion Time : 4 \pm 1sec
4	Drop Test	After test, the chip inductor don't fell of broke on the P.C.Board	Drop 1 time for each face and 1 time for each corner. Total drop 10 times. Drop Height : 100cm Drop Weight : 125g
5	Solderability Test	The terminal should at least be 90% covered with solder	after fluxing (alpha 100 or equiv), inductor shall be dipped in a melted solder bath at 232 \pm 5°C for 5 seconds.
6	Resistance to solvent test	There shall be no case of deformation change in appearance of obliteration of marking	MIL-STD202F, METHOD 215D



RoHS Compliant

NOTE : Specifications subject to change without notice. Please check our website for latest information.

22.06.2010



SUPERWORLD ELECTRONICS (S) PTE LTD

PG. 6

Climatic Test :

ITEM		SPECIFICATION	TEST CONDITIONS / TEST METHODS															
1	Temperature Characteristics	Appearance : No damage L change : within $\pm 10\%$ Q change : within $\pm 20\%$	-40°C ~ +125°C															
2	Humidity Resistance		Temperature : $40\pm 2^\circ\text{C}$ Relative Humidity : 90~95% Time : 96hrs ± 2 hrs Measured after exposure in the room condition for 2hrs															
3	Low Temperature Storage Test		Temperature : $-40\pm 2^\circ\text{C}$ Time : 48 ± 2 hrs Inductors are to be tested after 1 hour at room temperature.															
4	Thermal Shock Test		One cycle : <table border="1" style="margin-left: 20px;"> <thead> <tr> <th>Step</th> <th>Temperature ($^\circ\text{C}$)</th> <th>Time (min)</th> </tr> </thead> <tbody> <tr> <td>1</td> <td>-25 ± 3</td> <td>30</td> </tr> <tr> <td>2</td> <td>25 ± 2</td> <td>15</td> </tr> <tr> <td>3</td> <td>85 ± 3</td> <td>30</td> </tr> <tr> <td>4</td> <td>25 ± 2</td> <td>15</td> </tr> </tbody> </table> Total : 5 cycles	Step	Temperature ($^\circ\text{C}$)	Time (min)	1	-25 ± 3	30	2	25 ± 2	15	3	85 ± 3	30	4	25 ± 2	15
Step	Temperature ($^\circ\text{C}$)		Time (min)															
1	-25 ± 3		30															
2	25 ± 2		15															
3	85 ± 3	30																
4	25 ± 2	15																
5	High Temperature Storage Test	Temperature : $125\pm 2^\circ\text{C}$ Time : 48 ± 2 hrs Load : Allowed DC current																
6	High Temperature Load Life Test	Temperature : $85\pm 2^\circ\text{C}$ Time : 1000 ± 12 hrs Load : Allowed DC current																
7	Humidity Load Life	Temperature : $40\pm 2^\circ\text{C}$ Relative Humidity : 90~95% Time : 1000 ± 12 hrs Load : Allowed DC current																



RoHS Compliant

NOTE : Specifications subject to change without notice. Please check our website for latest information.

22.06.2010



SUPERWORLD ELECTRONICS (S) PTE LTD