

**AllInGaP Red (630nm) MAN3H10, MAN3H40**  
**AllInGaP Red (642nm) MAN3R10, MAN3R40**  
**AllInGaP Yellow MAN3Y10, MAN3Y40**  
**GaP Green MAN3G10, MAN3G40**

TR/QTS/030100-002

**PACKAGE DIMENSIONS**

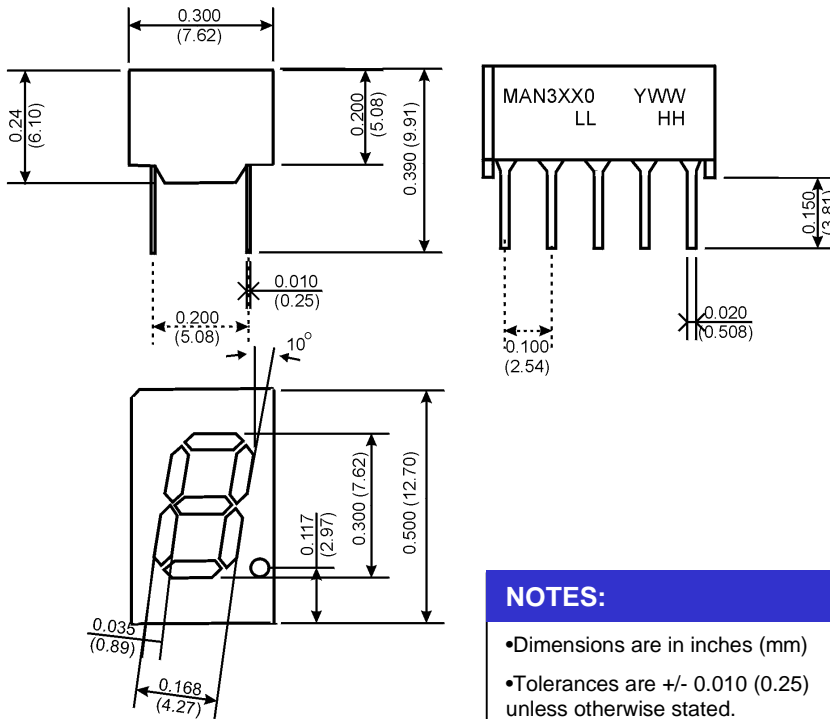

**FEATURES**

- Bright Bold Segments
- Common Anode/Cathode
- Low Power Consumption
- Low Current Capability
- Neutral Segments
- Grey Face
- Epoxy Encapsulated Frame
- High Performance
- High Reliability

**APPLICATIONS**

- Appliances
- Automotive
- Instrumentation
- Process Control

**MODELS AVAILABLE**

Part Number	Colour	Description	Recommended I <sub>F</sub> Levels
MAN3H10	AllInGaP 630nm	Single Digit, RHDP, Common Anode	Low Current (1mA - 5mA)
MAN3H40	AllInGaP 630nm	Single Digit, RHDP, Common Cathode	Low Current (1mA - 5mA)
MAN3R10	AllInGaP 642nm	Single Digit, RHDP, Common Anode	Low Current (1mA - 5mA)
MAN3R40	AllInGaP 642nm	Single Digit, RHDP, Common Cathode	Low Current (1mA - 5mA)
MAN3Y10	AllInGaP Yellow	Single Digit, RHDP, Common Anode	Low Current (1mA - 5mA)
MAN3Y40	AllInGaP Yellow	Single Digit, RHDP, Common Cathode	Low Current (1mA - 5mA)
MAN3G10	GaP Green	Single Digit, RHDP, Common Anode	Low Current (1mA - 5mA)
MAN3G40	GaP Green	Single Digit, RHDP, Common Cathode	Low Current (1mA - 5mA)

(For other colour options, contact your local area Sales Manager)

## ABSOLUTE MAXIMUM RATINGS<sup>(1)</sup> ( $T_A = 25^\circ\text{C}$ , unless otherwise specified)

Part Number	MAN3H10	MAN3R10	MAN3Y10	MAN3G10	
Parameter	MAN3H40	MAN3R40	MAN3Y40	MAN3G40	Units
<b>Continuous Forward Current</b> (each segment)	25	25	25	25	mA
<b>Peak Forward Current</b> ( $F = 10\text{KHz}$ , $D/F = 1/10$ )	100	100	100	100	mA
<b>Power Dissipation (<math>P_D</math>)</b>	60	60	60	60	mW
<b>*Derate Linearly from <math>25^\circ\text{C}</math></b>	0.36	0.36	0.36	0.36	mW
<b>Reverse Voltage per Die</b>					5 Volts
<b>Operating and Storage Temperature Range</b>					$-40^\circ\text{C}$ to $+85^\circ\text{C}$
<b>Lead soldering time (1/16 inch from standoffs)</b>					5 seconds @ $230^\circ\text{C}$

## ELECTRO-OPTICAL CHARACTERISTICS<sup>(1)</sup> ( $T_A = 25^\circ\text{C}$ , unless otherwise specified)

Part Number	MAN3H10	MAN3R10	MAN3Y10	MAN3G10		
Parameter	MAN3H40	MAN3R40	MAN3Y40	MAN3G40	Units	Test Condition
<b>Luminous intensity<sup>(2)</sup> (<math>I_V</math>)</b>						
Minimum (Standard Current)	Note 4	Note 4	Note 4	1500	ucd	$I_F = 10\text{mA}$
Typical (Standard Current)	Note 4	Note 4	Note 4	2500	ucd	$I_F = 10\text{mA}$
Minimum (Low Current)	510	510	510	510	ucd	$I_F = 2\text{mA}$
Typical (Low Current)	1000	1000	1000	1000	ucd	$I_F = 2\text{mA}$
<b>Forward Voltage (<math>V_F</math>)</b>						
Typical (Standard Current)	2.05	2.05	2.05	2.05	Volts	$I_F = 10\text{mA}$
Maximum (Standard Current)	2.45	2.45	2.45	2.45	Volts	$I_F = 10\text{mA}$
Typical (Low Current)	1.80	1.80	1.80	1.80	Volts	$I_F = 2\text{mA}$
Maximum (Low Current)	2.20	2.20	2.20	2.20	Volts	$I_F = 2\text{mA}$
<b>Peak Wavelength</b>	632	639	591	565	nm	$I_F = 10\text{mA}$
<b>Dominant Wavelength</b>	624	631	585	570	nm	$I_F = 10\text{mA}$
<b>Spectral Line 1/2 Width</b>	20	20	20	20	nm	$I_F = 10\text{mA}$
<b>Reverse B<sup>(3)</sup>.Voltage (<math>V_R</math>)</b>	5	5	5	5	Volts	$I_R = 100\mu\text{A}$

**NOTES:**

(1) Data per individual LED element

(2) Luminous intensity (ucd) = average light output per segment

(3) B = breakdown

(4) High current operation of these Superbright Displays results in cross-talk (light bleed from a lit to a non lit segment) - maximum drive current recommended to contain cross-talk is 5mA

**PIN ORIENTATION, SEGMENT IDENTIFICATION, AND PRODUCT MARKING**

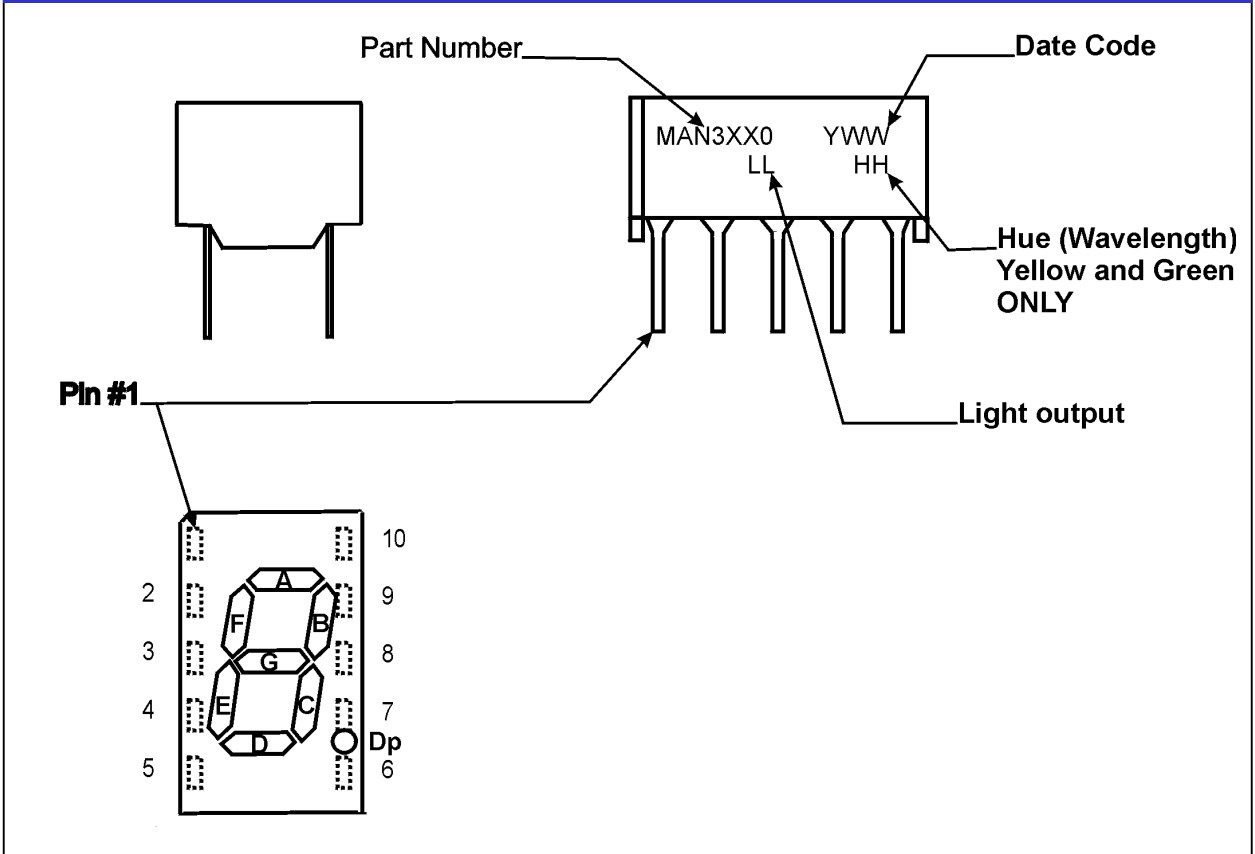

**SCHEMATICS**

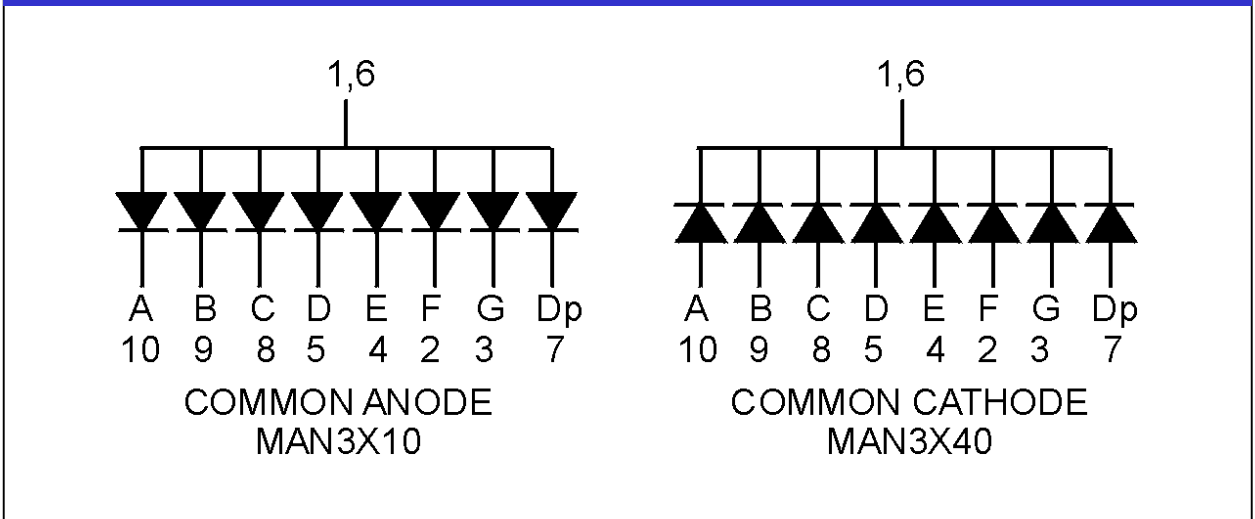

**GRAPHICAL DATA AllnGaP 630nm ( $T_A = 25^\circ\text{C}$ , unless otherwise specified)**

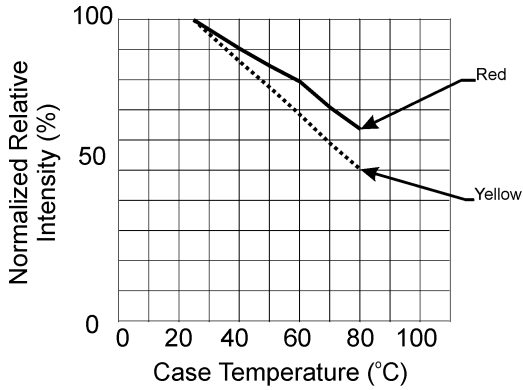

**Relative Intensity vs Case Temp.**

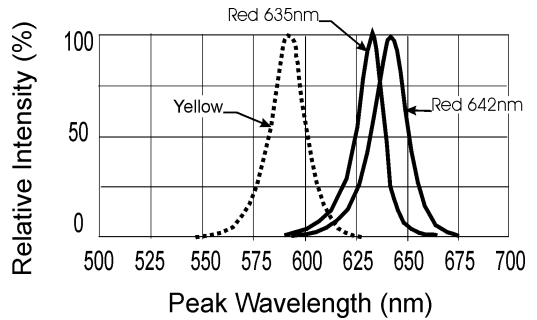

**Spectral Response**

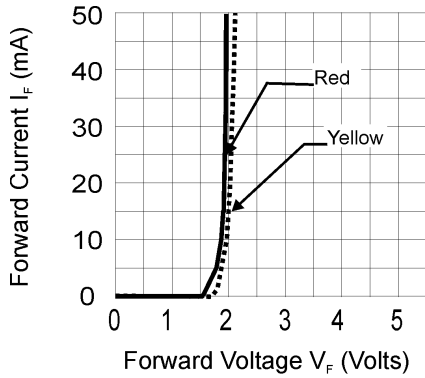

**Forward Current vs Forward Voltage**

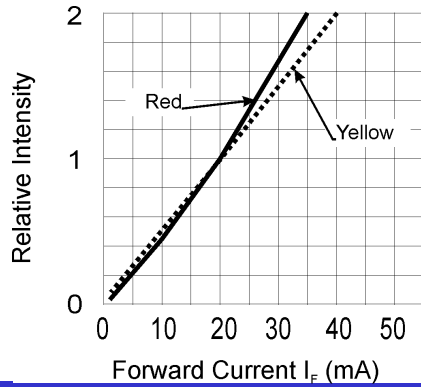

**Luminous Intensity vs Duty Cycle**

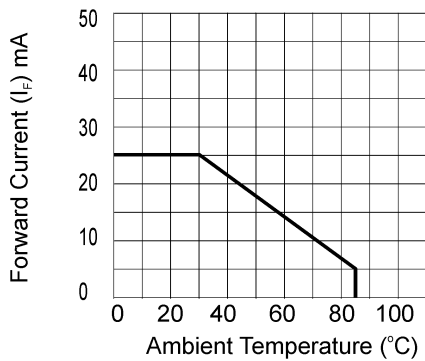

**Maximum Forward Current vs Ambient Temperature**

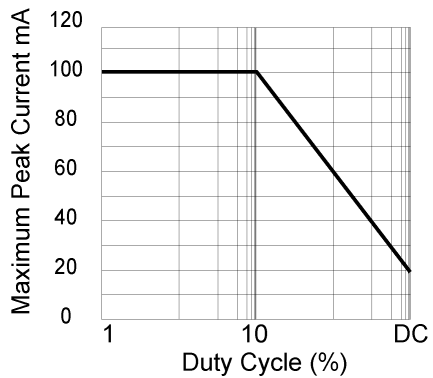

**Maximum Peak Current vs Duty Cycle**

**GRAPHICAL DATA GaP Green ( $T_A = 25^\circ\text{C}$ , unless otherwise specified)**

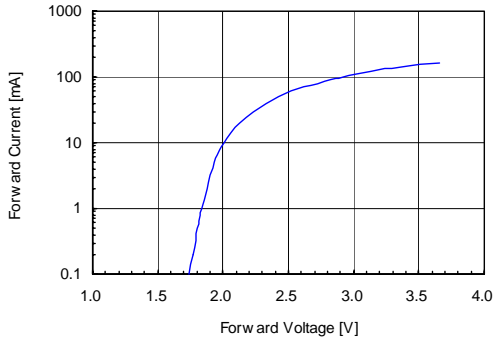

**Forward Current vs Forward Voltage**

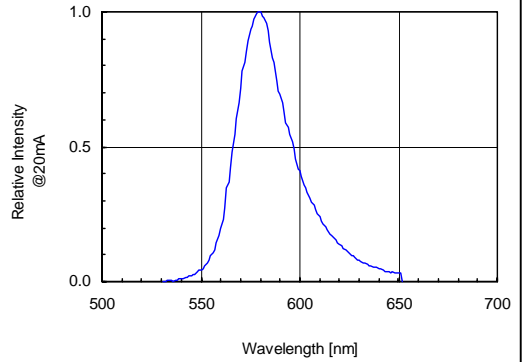

**Spectral Response**

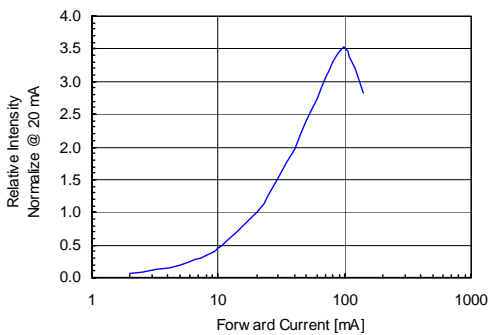

**Relative Intensity vs Forward Current**

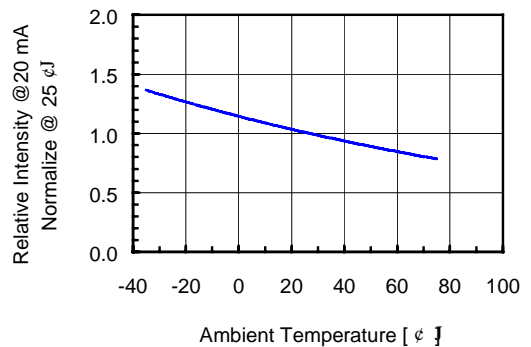

**Relative Intensity vs Ambient Temperature**

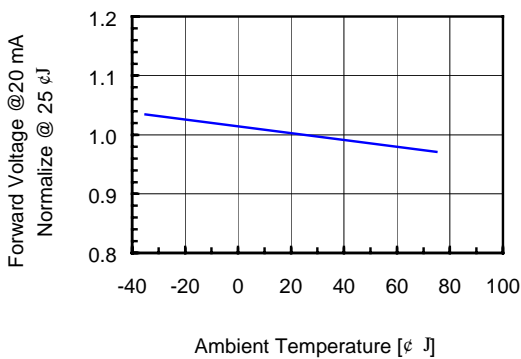

**Forward Voltage vs Ambient Temperature**



## 0.3 Inch (7.62mm) COMPACT LOW CURRENT NUMERIC FRAME DISPLAY

---

### DISCLAIMER

FAIRCHILD SEMICONDUCTOR RESERVES THE RIGHT TO MAKE CHANGES WITHOUT FURTHER NOTICE TO ANY PRODUCTS HEREIN TO IMPROVE RELIABILITY, FUNCTION OR DESIGN. FAIRCHILD DOES NOT ASSUME ANY LIABILITY ARISING OUT OF THE APPLICATION OR USE OF ANY PRODUCT OR CIRCUIT DESCRIBED HEREIN; NEITHER DOES IT CONVEY ANY LICENSE UNDER ITS PATENT RIGHTS, NOR THE RIGHTS OF OTHERS.

### LIFE SUPPORT POLICY

FAIRCHILD'S PRODUCTS ARE NOT AUTHORIZED FOR USE AS CRITICAL COMPONENTS IN LIFE SUPPORT DEVICES OR SYSTEMS WITHOUT THE EXPRESS WRITTEN APPROVAL OF THE PRESIDENT OF FAIRCHILD SEMICONDUCTOR CORPORATION. As used herein:

1. Life support devices or systems are devices or systems which, (a) are intended for surgical implant into the body, or (b) support or sustain life, and (c) whose failure to perform when properly used in accordance with instructions for use provided in the labeling, can be reasonably expected to result in a significant injury of the user.
2. A critical component in any component of a life support device or system whose failure to perform can be reasonably expected to cause the failure of the life support device or system, or to affect its safety or effectiveness.