

- Standard gain guided type MQW InGaAlP VLD
- Package flange: $\varnothing 9\text{mm}$
- Applications include:
Bar code scanners, laser pointer, measurement systems, etc.

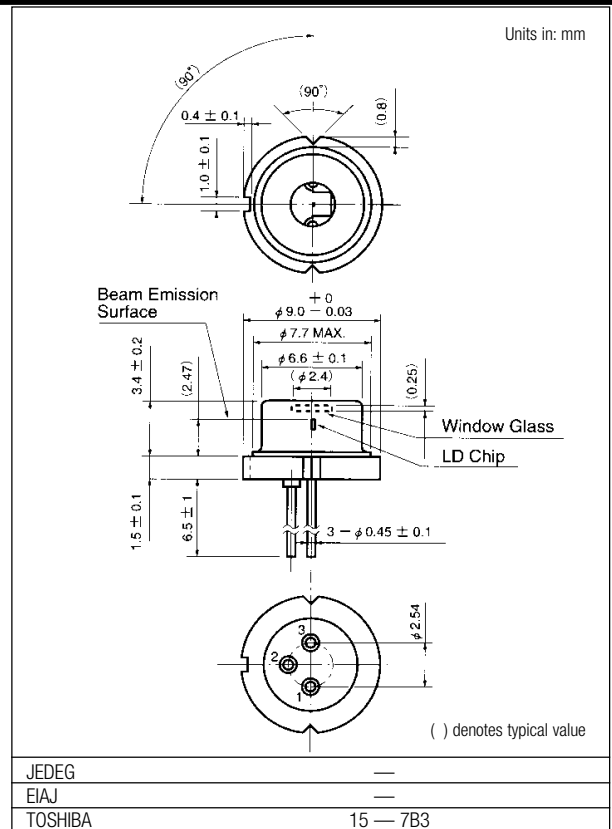
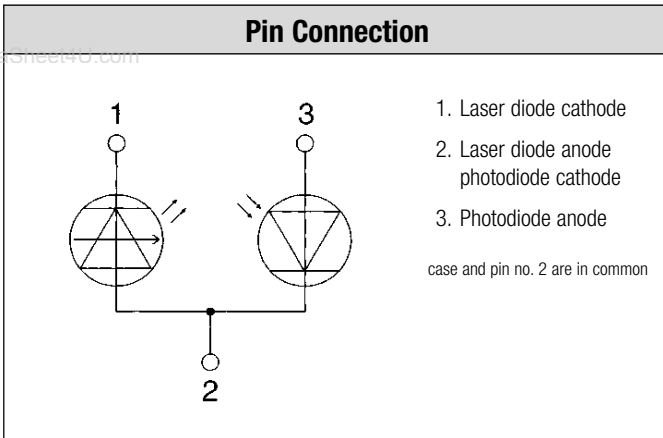

Maximum ratings (Tc=25°C)

Characteristic	Symbol	Rating	Unit
Optical Output Power(CW)	P_O	3	mW
LD Reverse Voltage	$V_{R(LD)}$	2	V
PD Reverse Voltage	$V_{R(PD)}$	30	V
Operation Case Temperature	T_C	-10~50	°C
Storage Temperature	T_{stg}	-40~85	°C

Optical-electrical characteristics (Tc=25°C)

Characteristic	Symbol	Test Condition	Min.	Typ.	Max.	Unit
Threshold Current	I_{th}	CW operation	—	50	75	mA
Operation Current	I_{op}	$P_o=3\text{mW}$	—	55	80	mA
Operation Voltage	V_{op}	$P_o=3\text{mW}$	—	2.2	3.0	V
Lasing Wavelength	λ_p	$P_o=3\text{mW}$	660	670	680	nm
Beam Divergence	$\theta_{ }$	$P_o=3\text{mW}$	7	10	16	°
	θ_{\perp}	$P_o=3\text{mW}$	26	32	38	°
Monitor Current	I_m	$P_o=3\text{mW}$	0.15	0.5	0.95	mA
PD Dark Current	$I_{b(PD)}$	$V_R=5\text{V}$	—	—	100	nA
PD Total Capacitance	$C_{T(PD)}$	$V_R=5\text{V}$, $f=1\text{MHz}$	—	—	20	pF

Examples of Typical Characteristics

Optical Output Power vs. Forward Current

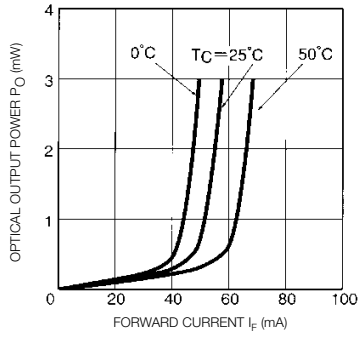

Forward Current vs. Forward Voltage

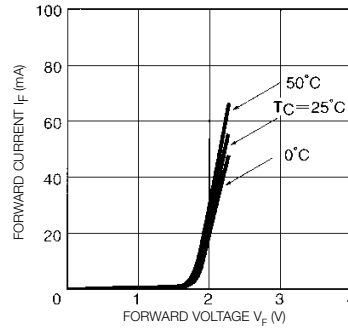

Case Temperature Dependence of Threshold Current

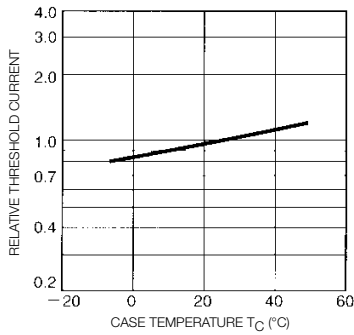

Case Temperature Dependence of Lasing Wavelength

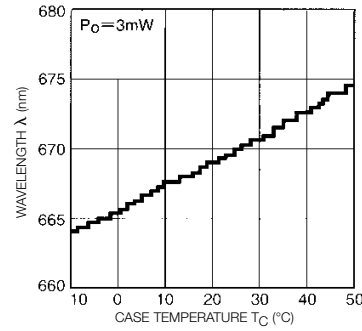

Far-field Patterns

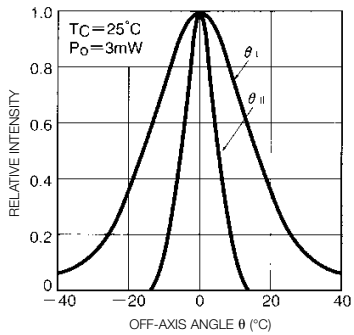

Lasing Spectrum

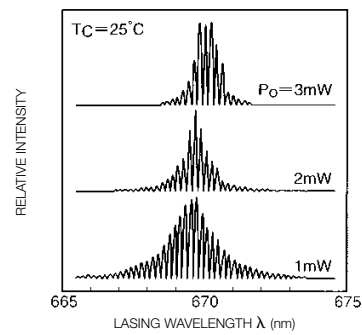

Monitor current vs. Optical Output Power

