

MOS DIGITAL INTEGRATED CIRCUITS

μ PD1708AG-020, μ PD1708AG-220

PLL FREQUENCY SYNTHESIZER AND CONTROLLER FOR MOBILE FM/MW/LW RADIO WITH CLOCK

DESCRIPTION

The μ PD1708AG-020/ μ PD1708AG-220, a CMOS LSI chip developed for worldwide PLL frequency synthesizer FM/MW/LW radios, is a 52pin flat package incorporating PLL, controller, prescaler, and LCD driver. It enables construction of a compact, high-performance FM/MW/LW digital tuning system equipped with a clock, such as a car stereo, home stereo, and radio cassette.

FEATURES

- Single power supply 5 V \pm 10 %
- LCD direct drive (1/2 duty, 1/2 bias drive, frame frequency: 100 Hz)
- Built-in prescaler
- Built-in 12 hour/24 hour clock
- 6-station preset memory (6 FM/MW/LW stations can be preset, independent of each other, with 6 buttons.)
- Manual up/down and auto up/down (SCAN/SEEK) station selection (saw tooth tuning)
- Endless rotary switch can be used for manual up/down.
- FM/MW/LW stations in Europe, USA, Australia, Japan, South Africa, Latin America, and Middle East can be selected.
- The Japanese MW band has wide band range (522—1 629 kHz) for automotive radio information.
- Alternate switch or momentary switch can be used for band switching. Band switching can be done with one button.
- AM (MW/LW) IF offset is possible.
- Last channel memory memorizes one FM/MW/LW station each.
- ARI (traffic information) auto tuning is possible.
- STEREO can be indicated.
- Preset memory indication (number indication)
- Selectable lead type
 - Lead bended type : μ PD1708AG-020-00
 - Straight lead type : μ PD1708AG-220-03

ABSOLUTE MAXIMUM RATINGS

Power supply voltage	V_{DD}	-0.3 to +6.0	V
Input voltage	V_I	-0.3 to $+V_{DD} + 0.3$	V
Output voltage	V_O	-0.3 to $+V_{DD} + 0.3$	V
Output absorption current	I_O	10	mA
Operating temperature	T_{opt}	-40 to +85	$^{\circ}C$
Storage temperature	T_{stg}	-55 to +125	$^{\circ}C$

RECOMMENDED OPERATING CONDITIONS

CHARACTERISTIC	SYMBOL	MIN.	TYP.	MAX.	UNIT	TEST CONDITION
Power supply voltage	V_{DD}	4.5	5.0	5.5	V	
Ambient temperature	T_a	-40		+85	$^{\circ}C$	
Input oscillation	V_{in}	0.3		4.5	Vp-p	AM pin
Input oscillation	V_{in}	0.5		4.5	Vp-p	FM pin

ELECTRICAL CHARACTERISTICS

(V_{DD} = +4.5 V to +5.5 V, T_a = -40 °C to 85 °C)

CHARACTERISTIC	SYMBOL	MIN.	TYP.	MAX.	UNIT	TEST CONDITION
Power supply voltage	V _{DD1}	4.5	5.0	5.5	V	CPU and PLL operation
Power supply voltage	V _{DD2}	3.5		5.5	V	CPU operation only (clock operation only)
Power supply current	I _{DD1}		15		mA	When 120 MHz is input from FM pin only
Power supply current	I _{DD2}		400		μA	CPU operation only (clock operation only)
Data retention voltage	V _{DR}	2.5		V _{DD}	V	When clock oscillation is stopped (no clock mode)
Data retention current	I _{DR}		1	10	μA	When clock oscillation is stopped (no clock mode) (V _{DD} =5 V)
High-level output current	I _{OH1}	-1.0	-2.5		mA	SD, MUTE, KS ₀ to KS ₅ , EO ₁ , EO ₂ pins (V _{OH} =V _{DD} - 1 V)
High-level output current	I _{OH2}	-10	-18		μA	LCD1 to LCD23 pins (V _{OH} =V _{DD} - 1 V)
High-level output current	I _{OH3}	-20	-60		μA	COM1 and COM2 pins (V _{OH} =V _{DD} - 1 V)
Low-level output current	I _{OL1}	1.0	3.8		mA	SD, MUTE, FM BAND, AM BAND, EO ₁ , EO ₂ pins (V _{OL} =1 V)
Low-level output current	I _{OL2}	25	100		μA	KS ₀ to KS ₅ pins (V _{OL} =1 V)
Low-level output current	I _{OL3}	10	30		μA	LCD1 to LCD23 pins (V _{OL} =1 V)
Low-level output current	I _{OL4}	20	80		μA	COM1 and COM2 pins (V _{OL} =1 V)
High-level input current	I _{IH1}	10	35	60	μA	K ₀ to K ₃ pins (V _{IH} =V _{DD} =5 V)
High-level input current	I _{IH2}	100	300		μA	FM, AM, X1 pins (V _{IH} =V _{DD} =5 V)
Output leak current	I _L	-1		+1	μA	EO ₁ and EO ₂ pins (V _{DD} =V _{OL} =5 V, V _{OH} =0 V)
High-level input voltage	V _{IH1}	0.7 V _{DD}			V	SD, K ₄ , K ₅ pins
High-level input voltage	V _{IH2}	0.6 V _{DD}			V	K ₀ to K ₃ pins
High-level input voltage	V _{IH3}	0.8 V _{DD}			V	CE pin
Low-level input voltage	V _{IL1}			0.3 V _{DD}	V	SD, K ₄ , K ₅ pins
Low-level input voltage	V _{IL2}			0.2 V _{DD}	V	K ₀ to K ₃ pins
Low-level input voltage	V _{IL3}			0.2 V _{DD}	V	CE pin
Output level	V _O	2.3		2.8	V	COM1, COM2 pin 1/2 bias voltage (V _{DD} =5 V)
Operating frequency	f _{AML}	0.5		20	MHz	AM pin V _i =0.1 V _{p-p} (V _{DD} =4.5 V)
Operating frequency	f _{FM-1}	10		130	MHz	FM pin V _i =0.3 V _{p-p} (V _{DD} =4.5 V)
Operating frequency	f _{FM-2}	10		150	MHz	FM pin V _i =0.5 V _{p-p} (V _{DD} =4.5 V)

FUNCTION OUTLINE

Receive frequency, comparison frequency, channel space, and intermediate frequency

Area	Band	Item	FREQUENCY RANGE	CHANNEL SPACING	REFERENCE FREQUENCY	INTERMEDIATE FREQUENCY
Europe		FM	87.50 MHz to 108.00 MHz	50 kHz	25 kHz	10.70 MHz
		MW	522 kHz to 1 620 kHz	9 kHz	9 kHz	450,459 kHz
		LW	153 kHz to 281 kHz	1 kHz (Note 1)	1 kHz	
USA1		FM	87.5 MHz to 108.0 MHz	100 kHz	25 kHz	10.7 MHz
		MW	530 kHz to 1 620 kHz	10 kHz	10 kHz	450,460 kHz
USA2		FM	87.5 MHz to 107.9 MHz	200 kHz	25 kHz	10.7 MHz
		MW	530 kHz to 1 620 kHz	10 kHz	10 kHz	450,460 kHz
Australia		FM	87.5 MHz to 108.0 MHz	100 kHz	25 kHz	10.7 MHz
Middle East		MW	531 kHz to 1 602 kHz	9 kHz	9 kHz	450,459 kHz
Latin America		FM	87.5 MHz to 108.0 MHz	100 kHz	25 kHz	10.7 MHz
		MW	520 kHz to 1 620 kHz	5 kHz	5 kHz	450,455 kHz
Japan		FM	76.0 MHz to 90.0 MHz	100 kHz	25 kHz	-10.7 MHz
		MW	522 kHz to 1 629 kHz	9 kHz	9 kHz	450,459 kHz
South Africa		FM	87.604 MHz to 107.986 MHz	86 kHz (Note 2)	10 kHz	-10.700 MHz
		MW	531 kHz to 1 602 kHz	9 kHz	9 kHz	450,459 kHz

- Notes: 1. Auto tuning stops at only 9 kHz step.
 2. Tunes up/down at 80 or 100 kHz steps to the frequency nearest the normal channel plan. (Maximum error: ±10 kHz) Frequency indication is 0 when the tens place of kHz is 0 to 4, and 5 when it is 5 to 9, ignoring units place of kHz.

Tuning function

- (1) Auto tuning (saw tooth mode)
 - Scan up/down: Receives at 5-second intervals.
 - Seek up/down: Once received, retains the station.
- (2) Manual tuning (saw tooth mode)
 - Manual up/down: Step up/down or fast feed by push-button switch. Pulse count tuning can be done with a rotary switch.
- (3) Preset memory call
 - Six FM/MW/LW stations can be selected independent of each other with six buttons. Last station memory is available for each band.

Clock function

24 hour/12 hour clock for Europe, and 12 hour clock in other areas (with AM/PM indication).

LCD check function

Checks the LCD assembly state or whether or not LCD lights up normally. During the initial power up (VDD: low to high), all segments of the LCD light up for about 1 second.

PIN DESCRIPTIONS

PIN CONFIGURATION (Top View)

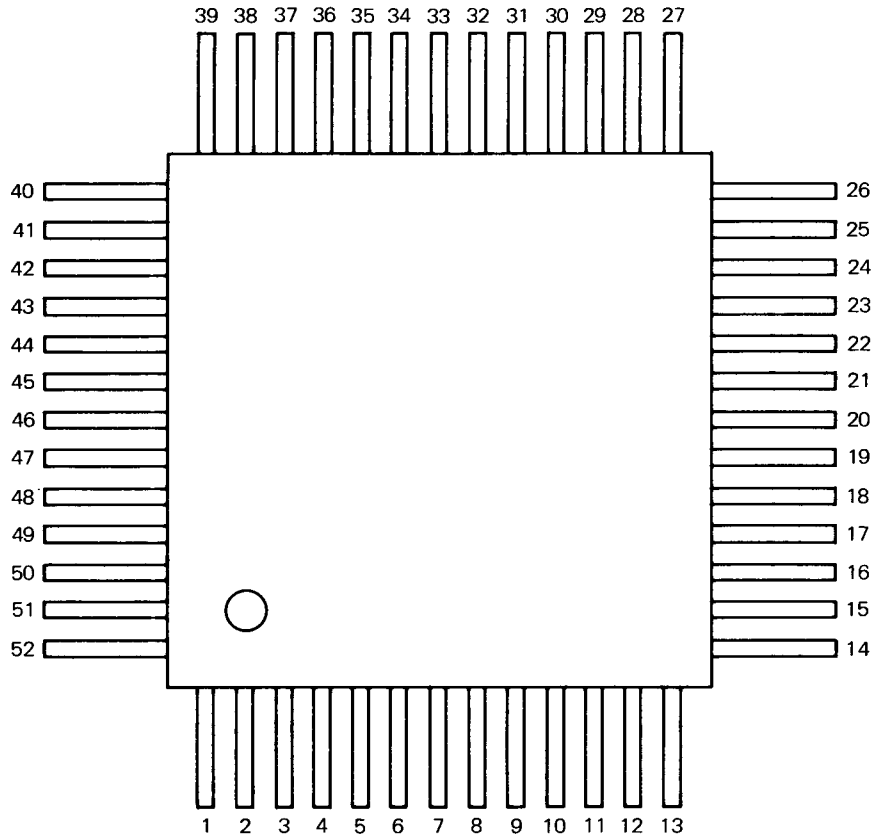

PIN NO.	PIN NAME	PIN NO.	PIN NAME
1	LCD4	52	LCD5
2	LCD3	51	LCD6
3	LCD2	50	LCD7
4	LCD1	49	LCD8
5	COM2	48	LCD9
6	COM1	47	LCD10
7	V _{DD}	46	LCD11
8	FM	45	LCD12
9	AM	44	LCD13
10	GND	43	LCD14
11	EO ₁	42	LCD15
12	EO ₂	41	LCD16
13	CE	40	LCD17
14	N.C.	39	LCD18
15	XI	38	LCD19
16	XO	37	LCD20
17	SD(PA ₃)	36	LCD21
18	MUTE(PA ₂)	35	LCD22
19	K ₅ (PA ₁)	34	LCD23
20	K ₄ (PA ₀)	33	* V _{DD}
21	K ₃	32	AM BAND(PC ₀)
22	K ₂	31	FM BAND(PC ₁)
23	K ₁	30	KS ₀ (PC ₂)
24	K ₀	29	KS ₁ (PC ₃)
25	KS ₅ (PB ₃)	28	KS ₂ (PB ₀)
26	KS ₄ (PB ₂)	27	KS ₃ (PB ₁)

*: Internally connected to pin 7.

N.C.: No Connection

PIN DESCRIPTION

PIN NO.	SYMBOL	PIN NAME	DESCRIPTION
1-4 34-52	LCD1 to LCD23	LCD segment signal	LCD segment signal output pin (LCD is 1/2 duty, 1/2 bias. Frame frequency is 100 Hz, and drive voltage is V_{DD} .)
5 6	COM2 COM1	LCD common Signal	LCD common signal output pin
7 33	V_{DD}	Power input	Device power supply pin 5 $V \pm 10\%$ power is supplied during device operation. It is also possible to supply power to pin 7 or 33 only. The rise time of V_{DD} must be 500 ms or less (0.0→4.5 V). If the rise time is too long or V_{DD} does not completely drop to 0 V, but rises from below operating voltage to 3.5 V, the initialization diode switch state may not be correctly read. In such a case, the CE pin is used to read the initialization diode switch state.
8	FM	FM VCO input	Inputs FM local oscillator output. AC amplifier is built in; cut DC with capacitor.
9	AM	LW, MW VCO input	Inputs LW/MW local oscillator output. AC amplifier is built in; cut DC with capacitor.
10	GND	Ground	Connect this pin to the set ground.
11 12	EO1 EO2	Error out	Charge pump output from the phase detector composing PLL. If the divided frequency is higher than the reference frequency, these pins output high level. If it is lower, low level is output. If it is equivalent, it results in floating. The same signal is output to EO ₁ and EO ₂ ; these pins can be connected to LPF (Low Pass Filter) of LW/MW/FM.
13	CE	Chip Enable	Device select signal input pin. High level to operate PLL, and low level to stop PLL. In low level, display becomes blank. Low level or high level under 134 μ s is not accepted. In clock mode, connect this pin to V_{DD} . In no-clock mode, set this pin to low level when radio is OFF, and high level when radio is ON. In no-clock mode, setting this pin to low level enters the radio in backup mode to enable backup with low current consumption. (10 μ A MAX.)
15 16	XI XO	Crystal	Connects crystal oscillator. Connects 4.5 MHz crystal oscillator.
17	SD	Station detection signal input	This input pin detects whether the station is received during auto tuning (auto UP/DOWN). (CMOS input) Input high level when station is received. It must be input within 50 ms (30 ms for European FM band) after dividing ratio changes.
18	$\overline{\text{MUTE}}$	Mute output	Outputs muting signal to suppress shock noise when PLL is unlocked; active low. (CMOS output) For details of timing, see *Mute Output Timing Chart.*

PIN NO.	SYMBOL	PIN NAME	DESCRIPTION															
19-24	K ₅ to K ₀	Key return signal input	Key matrix key return signal input pin. Connect pull-down resistor. (CMOS input)															
25-30	K _{S5} to K _{S0}	Key return signal source	Key source signal output pin. (CMOS output)															
31 32	FM BAND AM BAND	Band switching signal output	<p>Band switching signal output pin. (CMOS output) Outputs the following. (*1* means high level, and *0* means low level.)</p> <table border="1"> <thead> <tr> <th>Band \ Pin</th> <th>FM BAND</th> <th>AM BAND</th> </tr> </thead> <tbody> <tr> <td>FM</td> <td>1</td> <td>0</td> </tr> <tr> <td>MW</td> <td>0</td> <td>0</td> </tr> <tr> <td>LW</td> <td>0</td> <td>1</td> </tr> <tr> <td>VF</td> <td>1</td> <td>1</td> </tr> </tbody> </table> <p>←(VF mode in FM band)</p>	Band \ Pin	FM BAND	AM BAND	FM	1	0	MW	0	0	LW	0	1	VF	1	1
Band \ Pin	FM BAND	AM BAND																
FM	1	0																
MW	0	0																
LW	0	1																
VF	1	1																

1. KEY MATRIX CONFIGURATION

1.1 Key Matrix Layout

Input pin Output pin	K ₅ (19)	K ₄ (20)	K ₃ (21)	K ₂ (22)	K ₁ (23)	K ₀ (24)
KS ₅ (25)	MAN UP	MAN DOWN	M1	M2	VF	MEMORY
KS ₄ (26)	SCAN UP	SCAN DOWN	M3	M4	M5	M6
KS ₃ (27)	SEEK UP	SEEK DOWN	MINADJ	HORADJ	OADJ	RCAL
KS ₂ (28)	MODE1	MODE0	LOCK	LW	MW	FM
KS ₁ (29)	STEREO	SK	9N/9N+2	NOCLOCK	PRIORITY	ROTARY
KS ₀ (30)	BAND	DISLW	AMIF	AREA2	AREA1	AREA0

(): Pin No.

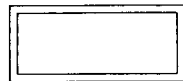

: Momentary switch

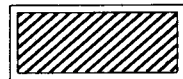

: Momentary or alternate switch



: Transistor switch

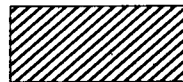

: Alternate or transistor switch



: Diode matrix (Diode short circuit or open)

1.2 Switch Connection

Momentary switch

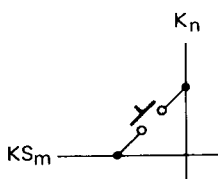

Alternate switch

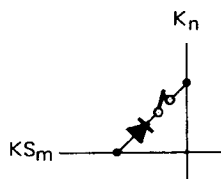

Diode matrix

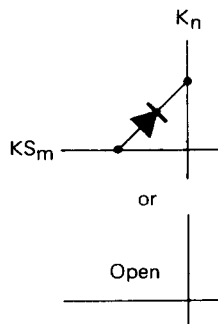

Transistor switch

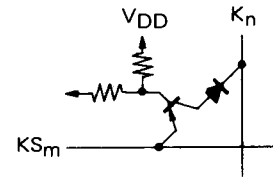

1.3 Key Matrix Connection Example

The band selection keys can be set as alternate or momentary switches; the diode (for preventing key source signal seep-in) insertion position differs by switch selection. Examples are shown below.

Key source (KS₀ to KS₅) has low sink current; the diode for backflow prevention on the key source side can be omitted.

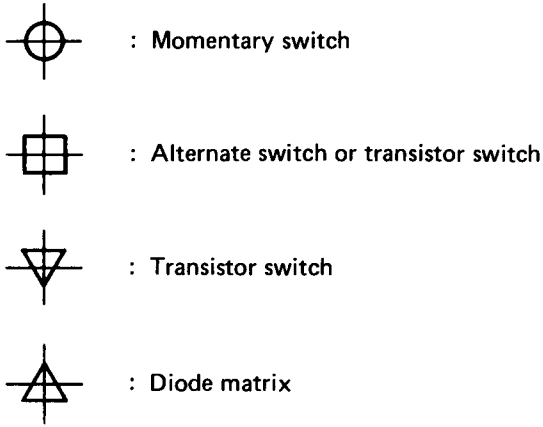

Example 1 Using momentary switch as band key

Example 2 Using alternate switch as band key

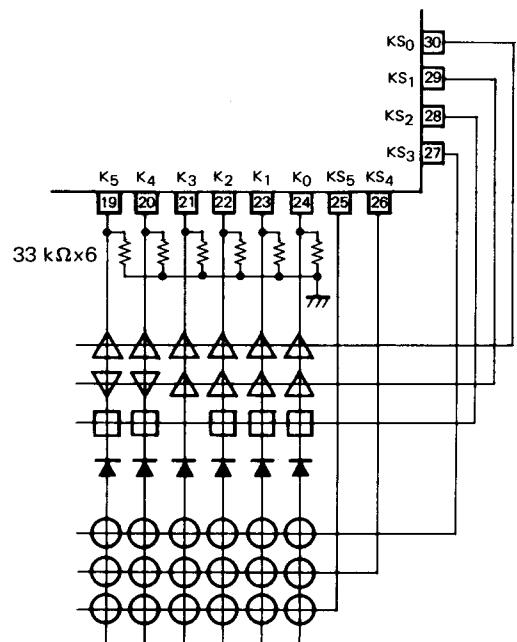
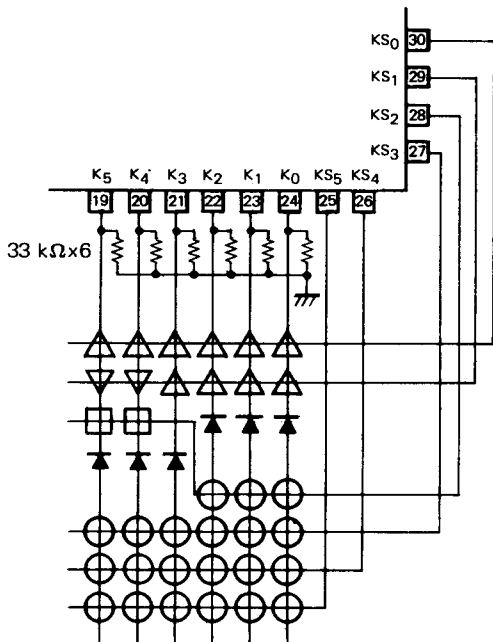

2. KEY MATRIX EXPLANATION

2.1 Initialization Diode Matrices

Eight types of initialization diode matrices are used, which are read at initial power up of V_{DD} (initialization) and when the CE pin changes from low to high level:

- (1) Switch to set the band key to one key
BAND
- (2) Switch to disable LW band
DISLW
- (3) Switch to set the IF offset value for MW and LW
AMIF
- (4) Switch to set area
AREA0, AREA1, AREA2
- (5) Switch to set stop frequency for LW band autotuning
9N/9N+2
- (6) Switch to set clock or no-clock mode
NOCLOCK
- (7) Switch to set display priority
PRIORITY
- (8) Switch to use the rotary switch for manual tuning
ROTARY

For the above settings, shortcircuit the crossing point concerned on the matrix with diode or leave it open, as preferred. (In the table below, "1" means diode shortcircuiting, and "0" means open.)

SYMBOL	FUNCTION																																													
<p>AMIF</p>	<p>Switch to set IF offset value for MW and LW bands. Intermediate frequency can be set as shown in the following table without changing the displayed frequency:</p> <table border="1" data-bbox="379 302 1385 464"> <thead> <tr> <th>AMIF</th> <th>Europe, Australia, Middle East, Japan, South America bands</th> <th>USA band</th> <th>Latin America band</th> </tr> </thead> <tbody> <tr> <td>0</td> <td>450 kHz</td> <td>450 kHz</td> <td>450 kHz</td> </tr> <tr> <td>1</td> <td>459 kHz</td> <td>460 kHz</td> <td>455 kHz</td> </tr> </tbody> </table>	AMIF	Europe, Australia, Middle East, Japan, South America bands	USA band	Latin America band	0	450 kHz	450 kHz	450 kHz	1	459 kHz	460 kHz	455 kHz																																	
AMIF	Europe, Australia, Middle East, Japan, South America bands	USA band	Latin America band																																											
0	450 kHz	450 kHz	450 kHz																																											
1	459 kHz	460 kHz	455 kHz																																											
<p>AREA2 AREA1 AREA0</p>	<p>Switch to set area for FM and MW Band. The band and clock display mode can be selected as follows:</p> <table border="1" data-bbox="379 576 1209 990"> <thead> <tr> <th>AREA2</th> <th>AREA1</th> <th>AREA0</th> <th>Area</th> <th>Clock</th> </tr> </thead> <tbody> <tr> <td>0</td> <td>1</td> <td>0</td> <td>USA 1</td> <td>12-hour clock</td> </tr> <tr> <td>0</td> <td>1</td> <td>1</td> <td>USA 2</td> <td>12-hour clock</td> </tr> <tr> <td>0</td> <td>0</td> <td>1</td> <td>Australia, Middle East</td> <td>12-hour clock</td> </tr> <tr> <td>0</td> <td>0</td> <td>0</td> <td>Europe</td> <td>24-hour clock</td> </tr> <tr> <td>1</td> <td>1</td> <td>1</td> <td>Europe</td> <td>12-hour clock</td> </tr> <tr> <td>1</td> <td>0</td> <td>0</td> <td>Japan</td> <td>12-hour clock</td> </tr> <tr> <td>1</td> <td>0</td> <td>1</td> <td>South Africa</td> <td>12-hour clock</td> </tr> <tr> <td>1</td> <td>1</td> <td>0</td> <td>Latin America</td> <td>12-hour clock</td> </tr> </tbody> </table>	AREA2	AREA1	AREA0	Area	Clock	0	1	0	USA 1	12-hour clock	0	1	1	USA 2	12-hour clock	0	0	1	Australia, Middle East	12-hour clock	0	0	0	Europe	24-hour clock	1	1	1	Europe	12-hour clock	1	0	0	Japan	12-hour clock	1	0	1	South Africa	12-hour clock	1	1	0	Latin America	12-hour clock
AREA2	AREA1	AREA0	Area	Clock																																										
0	1	0	USA 1	12-hour clock																																										
0	1	1	USA 2	12-hour clock																																										
0	0	1	Australia, Middle East	12-hour clock																																										
0	0	0	Europe	24-hour clock																																										
1	1	1	Europe	12-hour clock																																										
1	0	0	Japan	12-hour clock																																										
1	0	1	South Africa	12-hour clock																																										
1	1	0	Latin America	12-hour clock																																										
<p>9N/9N+2</p>	<p>Switch to set the stop frequency for LW band autotuning (SEEK, SCAN). LW band autotuning is done at 1 kHz steps at the timing shown in (3) of Section 4. Up/down is stopped only at the frequency set with this switch.</p> <table border="1" data-bbox="379 1143 1235 1268"> <thead> <tr> <th>9N/9N+2</th> <th>Stop frequency</th> </tr> </thead> <tbody> <tr> <td>0</td> <td>153, 162, 171, 180, 189, 198 270, 279 kHz</td> </tr> <tr> <td>1</td> <td>155, 164, 173, 182, 191, 200 272, 281 kHz</td> </tr> </tbody> </table>	9N/9N+2	Stop frequency	0	153, 162, 171, 180, 189, 198 270, 279 kHz	1	155, 164, 173, 182, 191, 200 272, 281 kHz																																							
9N/9N+2	Stop frequency																																													
0	153, 162, 171, 180, 189, 198 270, 279 kHz																																													
1	155, 164, 173, 182, 191, 200 272, 281 kHz																																													
<p>NOCLOCK</p>	<p>Switch to select clock or no-clock mode. When the no-clock mode is selected, backup with low power consumption is enabled by setting the CE pin to low level. (10 μA MAX.)</p> <table border="1" data-bbox="561 1379 1043 1508"> <thead> <tr> <th>NO CLOCK</th> <th>Clock/no-clock mode</th> </tr> </thead> <tbody> <tr> <td>0</td> <td>Clock mode</td> </tr> <tr> <td>1</td> <td>No-clock mode</td> </tr> </tbody> </table>	NO CLOCK	Clock/no-clock mode	0	Clock mode	1	No-clock mode																																							
NO CLOCK	Clock/no-clock mode																																													
0	Clock mode																																													
1	No-clock mode																																													
<p>PRIORITY</p>	<p>Switch to select display priority. This switch setting is invalid when the display mode determined by MODE 0 and MODE 1 is not priority display.</p> <table border="1" data-bbox="561 1628 1043 1757"> <thead> <tr> <th>PRIORITY</th> <th>Display mode</th> </tr> </thead> <tbody> <tr> <td>0</td> <td>Clock priority</td> </tr> <tr> <td>1</td> <td>Frequency priority</td> </tr> </tbody> </table>	PRIORITY	Display mode	0	Clock priority	1	Frequency priority																																							
PRIORITY	Display mode																																													
0	Clock priority																																													
1	Frequency priority																																													

SYMBOL	FUNCTION						
ROTARY	<p>Switch to select whether or not to use the rotary switch for manual tuning. When this switch is set to ON, the key chattering time is shortened to enable response to the high-speed pulse.</p> <table border="1"> <thead> <tr> <th>ROTARY</th> <th>MANUP, MANDOWN Key</th> </tr> </thead> <tbody> <tr> <td>0</td> <td>Momentary switch</td> </tr> <tr> <td>1</td> <td>Rotary switch</td> </tr> </tbody> </table>	ROTARY	MANUP, MANDOWN Key	0	Momentary switch	1	Rotary switch
ROTARY	MANUP, MANDOWN Key						
0	Momentary switch						
1	Rotary switch						
BAND	<p>Switch to select whether or not to set the band key to one key. When this switch is set to ON, the band switches \uparrowFM\rightarrowMW\rightarrowLW\downarrow cyclically each time a band key (FM/MW/LW) is pressed. If the DISLW switch is set to ON, the band switching is between FM and MW only. The alternate switch cannot be used for the band key when this switch is set to ON. When this switch is set to OFF, a band is selected by pressing the FM, MW, or LW key.</p>						
DISLW	<p>Switch to disable the LW band. The LW band selection is disabled by setting this switch to ON while the BAND switch is set to ON.</p>						

2.2 Mode Selection Switches

These switch settings can be changed at any time.

SYMBOL	FUNCTION																														
MODE1 MODE0	<p>Switch the display mode as shown in the following table. (These operations are done with CE = high level.) These switches are invalid in the no-clock mode (NO CLOCK = 1).</p> <table border="1"> <thead> <tr> <th>MODE1</th> <th>MODE0</th> <th>Display mode</th> <th>Priority</th> <th>IC operation</th> <th>Keys accepted</th> </tr> </thead> <tbody> <tr> <td>0</td> <td>0</td> <td>Clock only</td> <td>Clock only</td> <td>Clock operation and memory retention</td> <td>Time adjust keys and MODE0, MODE1</td> </tr> <tr> <td>1</td> <td>0</td> <td>Frequency and clock</td> <td>Set by PRIORITY switch (Note 1)</td> <td>All functions</td> <td>All keys</td> </tr> <tr> <td>0</td> <td>1</td> <td>No display</td> <td>—</td> <td>Clock operation and memory retention</td> <td>MODE0, MODE1 only</td> </tr> <tr> <td>1</td> <td>1</td> <td>Frequency and clock</td> <td>None (Note 2)</td> <td>All functions</td> <td>All keys</td> </tr> </tbody> </table> <p>Notes: 1. ○ While the priority is set to frequency, the frequency is displayed in normal operation and, when the RCAL key is pressed, the time is displayed for only 5 seconds, then the mode returns to frequency display. If the RCAL key is pressed again or any station selection key is pressed within 5 seconds after the RCAL key is pressed, the mode returns to frequency display.</p> <p>○ While the priority is set to clock, the RCAL key operation displays the frequency of the selected station for only 5 seconds. However, frequency display lasts until 5 seconds after the autotuning or manual tuning fast-feed operation is completed if such operation is selected. The mode returns to time display upon pressing the RCAL key during frequency display.</p> <p>2. ○ The 5-second timer is not affected by display switching; it operates only when the RCAL key or station selection key is operated.</p> <p>RCAL key : Each time this key is pressed, display changes between time and frequency. Station key : During time display, frequency is displayed when a station key is set to ON. Station keys are as follows: MANUP, MANDOWN, SCANUP, SCANDOWN, SEEKUP, SEEKDOWN, M1–M6, VF</p>	MODE1	MODE0	Display mode	Priority	IC operation	Keys accepted	0	0	Clock only	Clock only	Clock operation and memory retention	Time adjust keys and MODE0, MODE1	1	0	Frequency and clock	Set by PRIORITY switch (Note 1)	All functions	All keys	0	1	No display	—	Clock operation and memory retention	MODE0, MODE1 only	1	1	Frequency and clock	None (Note 2)	All functions	All keys
MODE1	MODE0	Display mode	Priority	IC operation	Keys accepted																										
0	0	Clock only	Clock only	Clock operation and memory retention	Time adjust keys and MODE0, MODE1																										
1	0	Frequency and clock	Set by PRIORITY switch (Note 1)	All functions	All keys																										
0	1	No display	—	Clock operation and memory retention	MODE0, MODE1 only																										
1	1	Frequency and clock	None (Note 2)	All functions	All keys																										

SYMBOL	FUNCTION
MODE1 MODE0	When the CE pin is set to low (GND), the IC operation is limited to clock operation and memory retention regardless of these switch settings; no display appears nor is any key operation accepted. (Clock mode (NO CLOCK = 0))

2.3 Transistor Switches

SYMBOL	FUNCTION
SK	Set this switch to ON when a traffic information station is received. Operation stops during ARI autotuning by the input from the SD pin and this switch operation.
STEREO	Switch to indicate stereo broadcasting. When this switch is set to ON, the STEREO indication on the LCD panel lights up. This display is done only during frequency display, that is, while the CE pin is at low level or during clock-only operation. This switch is invalid in the display OFF mode.
LOCK	Key lock switch for M1–M6, ME. When this switch is set to ON, M1–M6, ME switches are useful for casset tape control switch. When LOCK switch is set to ON, M1–M6, ME switches are locked on frequency display mode. But on clock display mode, clock adjustment is enable using ME key.

2.4 Momentary Switches

SYMBOL	FUNCTION
MANUP MANDOWN	<p>Manual tuning key. Momentary switch or rotary pulse generation switch can be used. When ROTARY setting of the initialization switch is set to OFF, the rotary switch can be used if the momentary switch is set to ON. In the momentary switch mode, this can be used for time adjustment of the clock.</p> <p>(i) Momentary switch mode (ROTARY = OFF)</p> <ul style="list-style-type: none"> ○ Frequency display mode Each time this switch is pressed, the frequency goes up (MANUP) or goes down (MANDOWN) by one step (channel space). The frequency goes up or down continuously by holding this key down for over 0.5 second. ○ Time display mode Press the MANUP or MANDOWN key while holding the MEMORY key to adjust the hour or minute. In this case, the MANUP key operates as the MINADJ key, and the MANDOWN key operates as the HORADJ key. <p>(ii) Rotary switch mode (ROTARY = ON) Each time this switch is set to ON, the frequency goes up (MANUP) or goes down (MANDOWN). The frequency goes up or down continuously at a rate of one step per second by holding this switch ON.</p>
M1 to M6	<p>Preset memory read/write key. For each button, FM, MW, and LW can be memorized independent of each other.</p> <p>(1) Memory Writing During frequency display, the currently received frequency is written in the memory which corresponds to the key pressed when one of M1 to M6 keys is pressed within 5 seconds after the MEMORY key is pressed.</p>

SYMBOL	FUNCTION																																																																																																
M1 to M6	<p>(2) Memory Call</p> <p>When any of M1 to M6 keys is pressed, the content (frequency) of the memory corresponding to the key pressed is recalled.</p> <p>The minimum frequency of the MW band is recalled when the radio is switched on after initial power up (input of V_{DD}). The following frequencies are assigned to M1 to M6 to make adjustment easy for mass production:</p> <table border="1" data-bbox="389 451 1358 1069"> <thead> <tr> <th colspan="2" data-bbox="389 451 826 499">Preset memory</th> <th data-bbox="826 451 911 499">M1</th> <th data-bbox="911 451 995 499">M2</th> <th data-bbox="995 451 1080 499">M3</th> <th data-bbox="1080 451 1165 499">M4</th> <th data-bbox="1165 451 1249 499">M5</th> <th data-bbox="1249 451 1358 499">M6</th> </tr> <tr> <th data-bbox="389 499 474 547">Band</th> <th data-bbox="474 499 826 547">Area</th> <th data-bbox="826 499 911 547"></th> <th data-bbox="911 499 995 547"></th> <th data-bbox="995 499 1080 547"></th> <th data-bbox="1080 499 1165 547"></th> <th data-bbox="1165 499 1249 547"></th> <th data-bbox="1249 499 1358 547"></th> </tr> </thead> <tbody> <tr> <td data-bbox="389 547 474 783" rowspan="5">FM</td> <td data-bbox="474 547 826 582">Europe</td> <td data-bbox="826 547 911 582">87.50</td> <td data-bbox="911 547 995 582">88.00</td> <td data-bbox="995 547 1080 582">98.00</td> <td data-bbox="1080 547 1165 582">106.00</td> <td data-bbox="1165 547 1249 582">108.00</td> <td data-bbox="1249 547 1358 582">87.50</td> </tr> <tr> <td data-bbox="474 582 826 658">USA 1/Australia/Middle East/Latin America</td> <td data-bbox="826 582 911 658">87.5</td> <td data-bbox="911 582 995 658">88.0</td> <td data-bbox="995 582 1080 658">98.0</td> <td data-bbox="1080 582 1165 658">106.0</td> <td data-bbox="1165 582 1249 658">108.0</td> <td data-bbox="1249 582 1358 658">87.5</td> </tr> <tr> <td data-bbox="474 658 826 694">USA 2</td> <td data-bbox="826 658 911 694">87.5</td> <td data-bbox="911 658 995 694">87.9</td> <td data-bbox="995 658 1080 694">97.9</td> <td data-bbox="1080 658 1165 694">105.9</td> <td data-bbox="1165 658 1249 694">107.9</td> <td data-bbox="1249 658 1358 694">87.5</td> </tr> <tr> <td data-bbox="474 694 826 729">Japan</td> <td data-bbox="826 694 911 729">76.0</td> <td data-bbox="911 694 995 729">80.0</td> <td data-bbox="995 694 1080 729">83.0</td> <td data-bbox="1080 694 1165 729">86.0</td> <td data-bbox="1165 694 1249 729">90.0</td> <td data-bbox="1249 694 1358 729">76.0</td> </tr> <tr> <td data-bbox="474 729 826 783">South Africa (Note)</td> <td data-bbox="826 729 911 783">87.60</td> <td data-bbox="911 729 995 783">88.00</td> <td data-bbox="995 729 1080 783">98.00</td> <td data-bbox="1080 729 1165 783">106.00</td> <td data-bbox="1165 729 1249 783">107.95</td> <td data-bbox="1249 729 1358 783">87.60</td> </tr> <tr> <td data-bbox="389 783 474 1031" rowspan="5">MW</td> <td data-bbox="474 783 826 818">Europe</td> <td data-bbox="826 783 911 818">522</td> <td data-bbox="911 783 995 818">603</td> <td data-bbox="995 783 1080 818">999</td> <td data-bbox="1080 783 1165 818">1 404</td> <td data-bbox="1165 783 1249 818">1 620</td> <td data-bbox="1249 783 1358 818">522</td> </tr> <tr> <td data-bbox="474 818 826 895">Australia/Middle East/South Africa</td> <td data-bbox="826 818 911 895">531</td> <td data-bbox="911 818 995 895">603</td> <td data-bbox="995 818 1080 895">999</td> <td data-bbox="1080 818 1165 895">1 404</td> <td data-bbox="1165 818 1249 895">1 602</td> <td data-bbox="1249 818 1358 895">531</td> </tr> <tr> <td data-bbox="474 895 826 930">USA</td> <td data-bbox="826 895 911 930">530</td> <td data-bbox="911 895 995 930">600</td> <td data-bbox="995 895 1080 930">1 000</td> <td data-bbox="1080 895 1165 930">1 400</td> <td data-bbox="1165 895 1249 930">1 620</td> <td data-bbox="1249 895 1358 930">530</td> </tr> <tr> <td data-bbox="474 930 826 965">Latin America</td> <td data-bbox="826 930 911 965">520</td> <td data-bbox="911 930 995 965">600</td> <td data-bbox="995 930 1080 965">1 000</td> <td data-bbox="1080 930 1165 965">1 400</td> <td data-bbox="1165 930 1249 965">1 620</td> <td data-bbox="1249 930 1358 965">520</td> </tr> <tr> <td data-bbox="474 965 826 1031">Japan</td> <td data-bbox="826 965 911 1031">522</td> <td data-bbox="911 965 995 1031">603</td> <td data-bbox="995 965 1080 1031">999</td> <td data-bbox="1080 965 1165 1031">1 404</td> <td data-bbox="1165 965 1249 1031">1 629</td> <td data-bbox="1249 965 1358 1031">522</td> </tr> <tr> <td data-bbox="389 1031 474 1069">LW</td> <td data-bbox="474 1031 826 1069">Europe</td> <td data-bbox="826 1031 911 1069">153</td> <td data-bbox="911 1031 995 1069">164</td> <td data-bbox="995 1031 1080 1069">218</td> <td data-bbox="1080 1031 1165 1069">272</td> <td data-bbox="1165 1031 1249 1069">281</td> <td data-bbox="1249 1031 1358 1069">153</td> </tr> </tbody> </table> <p>Note: The South African FM band in the above table shows the displayed frequencies, which differ from the actual frequencies received. (See 5. "South African FM Band Frequency Table" for the received frequencies.)</p>	Preset memory		M1	M2	M3	M4	M5	M6	Band	Area							FM	Europe	87.50	88.00	98.00	106.00	108.00	87.50	USA 1/Australia/Middle East/Latin America	87.5	88.0	98.0	106.0	108.0	87.5	USA 2	87.5	87.9	97.9	105.9	107.9	87.5	Japan	76.0	80.0	83.0	86.0	90.0	76.0	South Africa (Note)	87.60	88.00	98.00	106.00	107.95	87.60	MW	Europe	522	603	999	1 404	1 620	522	Australia/Middle East/South Africa	531	603	999	1 404	1 602	531	USA	530	600	1 000	1 400	1 620	530	Latin America	520	600	1 000	1 400	1 620	520	Japan	522	603	999	1 404	1 629	522	LW	Europe	153	164	218	272	281	153
Preset memory		M1	M2	M3	M4	M5	M6																																																																																										
Band	Area																																																																																																
FM	Europe	87.50	88.00	98.00	106.00	108.00	87.50																																																																																										
	USA 1/Australia/Middle East/Latin America	87.5	88.0	98.0	106.0	108.0	87.5																																																																																										
	USA 2	87.5	87.9	97.9	105.9	107.9	87.5																																																																																										
	Japan	76.0	80.0	83.0	86.0	90.0	76.0																																																																																										
	South Africa (Note)	87.60	88.00	98.00	106.00	107.95	87.60																																																																																										
MW	Europe	522	603	999	1 404	1 620	522																																																																																										
	Australia/Middle East/South Africa	531	603	999	1 404	1 602	531																																																																																										
	USA	530	600	1 000	1 400	1 620	530																																																																																										
	Latin America	520	600	1 000	1 400	1 620	520																																																																																										
	Japan	522	603	999	1 404	1 629	522																																																																																										
LW	Europe	153	164	218	272	281	153																																																																																										
MEMORY	<p>Preset memory write key. When ROTARY = OFF, this key can be used for time adjustment of the clock.</p> <ul style="list-style-type: none"> ○ Frequency display mode <p>Used to write a new frequency in the preset memory. Press one of the M1 to M6 keys within 5 seconds after MEMORY key is pressed, then the displayed frequency is written in the memory corresponding to the key pressed. When the MEMORY key is pressed, the 'ch' display on the LCD blinks at 1 Hz for 5 seconds, which indicates that you can write in the memory. To cancel the memory write enable state, press a key other than M1 to M6 and MEMORY.</p> ○ Time display mode <p>Press the MANUP or MANDOWN key while holding the MEMORY key down to adjust the minute or hour. The MANUP key operation is the same as the MINADJ key operation and the MANDOWN key operation is the same as the HORADJ key operation. (See MINADJ and HORADJ below.)</p> 																																																																																																
MINADJ	<p>Minute adjustment key. Each time this key is pressed, the time advances 1 minute. The minute setting continuously advances at a rate of 8 minutes/second by pressing this key for over 0.5 second until the key is released. No carry over to the hour setting. Although the second is not displayed, the second value is reset to 0 each time the minute setting is adjusted. This key is valid only in the time display mode.</p>																																																																																																

SYMBOL	FUNCTION
HORADJ	Hour adjustment key. Each time this key is pressed, the time advances 1 hour. The hour setting continuously advances at a rate of 4 hours/second by pressing this key for over 0.5 second until this key is released. The hour adjustment does not affect the minute or second setting. This key is valid only in the time display mode.
OADJ	Rounds down the minute and second settings to minute 0, second 0. This key is used for time setting. The hour setting remains if the minute setting is 29 minutes or less; however, if the minute setting is 30 minutes or more, the hour is advanced by 1 hour. This key is valid only in the time display mode.
SCANUP SCANDOWN	Autotuning key. Holds the frequency for 5 seconds if a high level is input to the SD pin during autotuning. Continues to receive the frequency if the SCANUP or SCANDOWN key is pressed again during this period. If no operation is done during this 5 seconds, autotuning is restarted. During this 5 second hold, the number display blinks to indicate the scan mode. Checks the SD pin again (also checks the SK signal in the VF mode) after muting following high level input to the SD pin and, if a high level input is found, receives the frequency; otherwise, restarts scanning immediately. Scan is restarted after 5 seconds even if a high level is input to the SD pin while this key is held down. To cancel scanning, release the key, then press it again.
SEEKUP SEEKDOWN	Autotuning key. Holds the current frequency if a high level is input to the SD pin during autotuning. Checks the SD pin again (also the SK signal in the VF mode) after muting (250–375 ms) following high level input to the SD pin and, if no high level is input, restarts the seek operation. Operation stops if this key is pressed during autotuning.
RCAL	Display switch. When this key is pressed, time display changes to frequency display, and vice versa if allowed by the display mode determined by the MODE0 and MODE1 switch settings. This switch is invalid in the no-clock mode (NO CLOCK = 1).
VF	Key to search for ARI (traffic information) broadcasting station. Each time this switch is pressed, the VF indication on the LCD panel blinks. When an autotuning key (SCANUP, SCANDOWN, SEEKUP, SEEKDOWN) is pressed in the VF mode (while the VF indication on the LCD panel is ON), scan or seek operation is done and, up/down operation is stopped only when a high level is input to the SD pin and the SK switch is set to ON. This key is invalid outside the FM band. When this key is pressed while receiving the FM band, the SD and SK signals are detected after 375 to 500 ms. If such a signal is not found, seek up operation is started at the frequency until an ARI broadcasting station is found.
FM MW LW	FM/MW/LW band selection switch. These keys can be operated by the momentary or alternate switch. Take the key for unused band, if any. If BAND = 1 is set, the band switches as follows each time FM or MW key is set to ON. <div style="text-align: center;"> $FM \rightarrow MW \rightarrow LW \text{ or } FM \rightleftarrows MW$ </div> <p>During band switching, a mute signal (about 750 ms) is output from the MUTE pin.</p>

Note:

During auto tuning, the frequency is changed after checking PLL lock. If PLL is unlocked during auto frequency change, waits until it is locked. During this time, the alternate switch can be operated, but the momentary key cannot be operated (band switching can be done). To change the frequency during adjustment of the set and PLL unlocking is expected, use the Preset Memory buttons (M1 to M6) or MANUP/MANDOWN. The PLL data can then be set whether or not the PLL is locked.

3. DISPLAY

3.1 LCD Panel

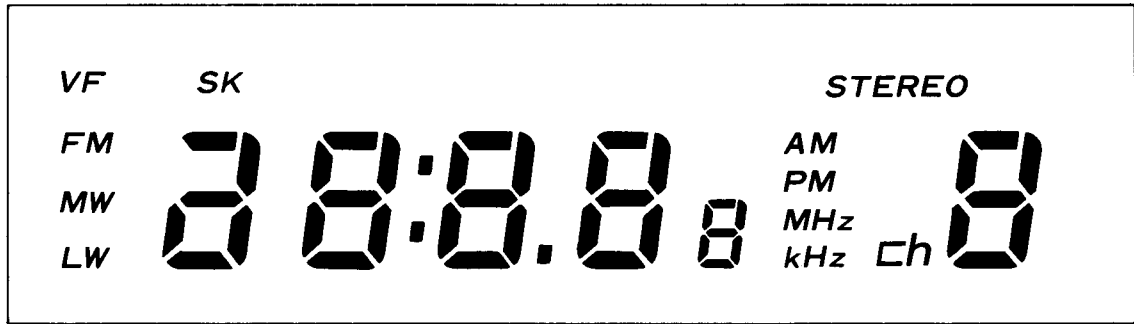

3.2 Display Type



3.3 LCD Pattern

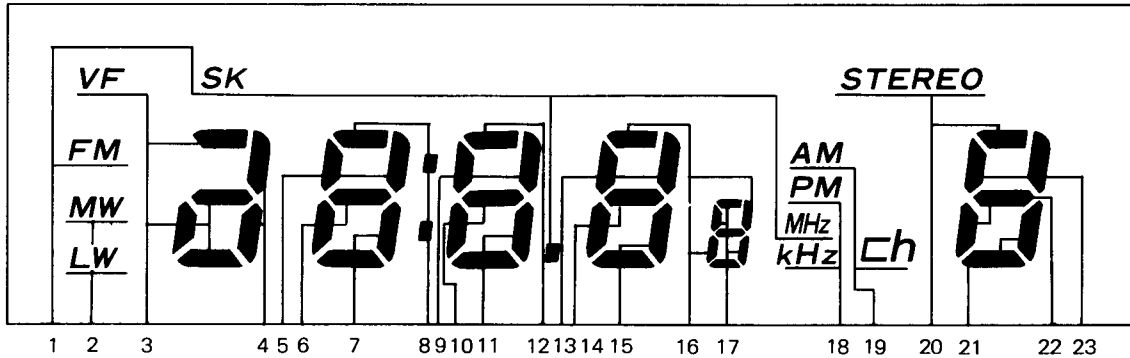

Segment line

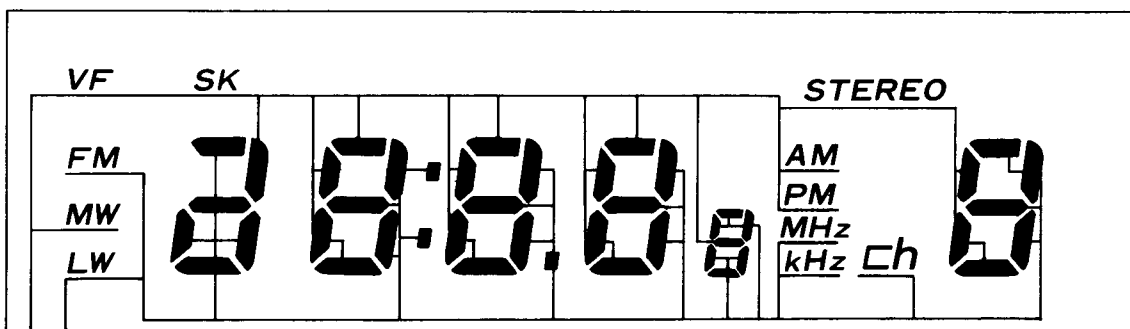

COM1
COM2

Common line

Note:

To blink display colon (:) during clock display, connect the segment line as follows:

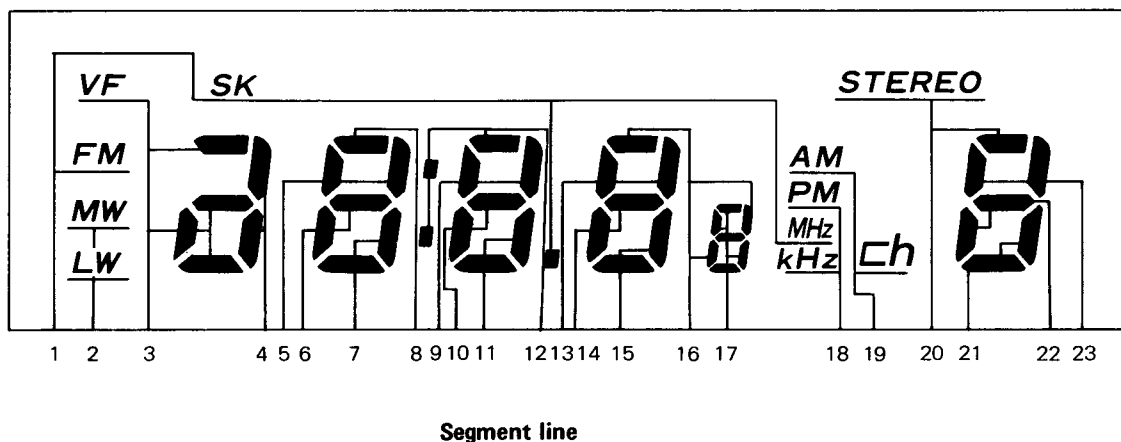

3.4 Display Explanation

DISPLAY	EXPLANATION
VF	Indicates the VF mode. This lights up only in the frequency display mode.
FM MW LW	Band display. The display which corresponds to the currently received band lights up only in the frequency display mode.
SK	Indicates that an SK signal is input. This is displayed only during frequency display in the FM band VF mode.
AM PM	A.M./P.M. indication for 12-hour clock.
STEREO	Indicates that a STEREO signal is input. This lights up in FM/MW/LW band only during frequency display.
MHz kHz	Lights up during frequency display. MHz lights up only for FM band, and kHz lights up for MW and LW bands.
ch 8	Lights up during preset memory display. It remains lighted when the preset memory is read or written, and it blinks at 1 Hz intervals when the preset memory can be written (for 5 seconds after the MEMORY key is pressed).
88888	The lowest digit lights up only for the FM band in Europe and South Africa. The lowest digit indicates only 0 or 5. The FM/MW/LW bands in other areas are indicated with the upper four digits only. (The uppermost digit is not used for the LW band.) The clock time is also displayed with the upper four digits.
(.) (decimal point)	Decimal point indication. This lights up during frequency display of the FM band.
(:) (colon)	Lights up during time display. It can remain lighted or blink at 1 Hz intervals, depending on the LCD segment line connection.

3.5 LCD Drive Signal

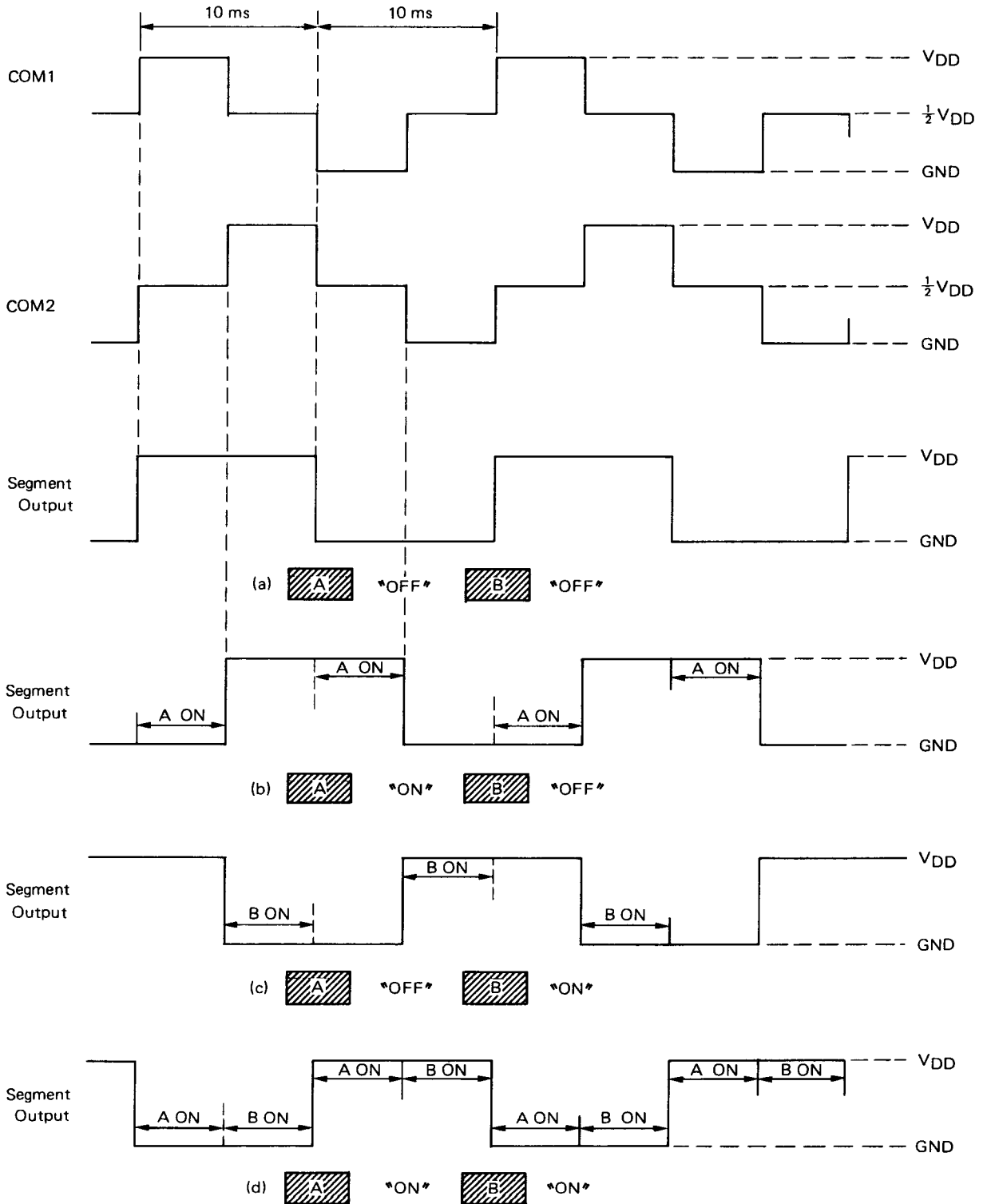
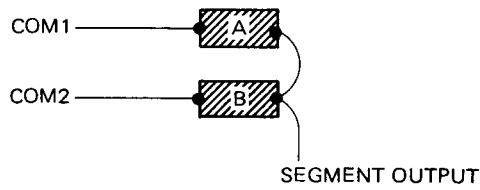

4. MUTE OUTPUT TIMING CHART

- ① Key ON chattering silence time
- ② Mute leading time
- ③ Dividing ratio setting and display contents update
- ④ Mute trailing time
- ⑤ Scan time
- ⑥ PLL lock time

(1) Manual up/down (momentary switch)

(i) When key is released within 0.5 second (outside band edge)

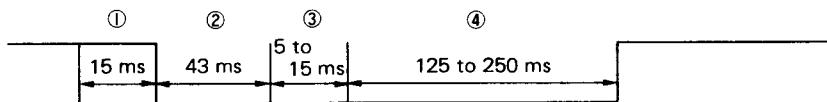

(ii) When key is released within 0.5 second (band edge: maximum frequency – minimum frequency)

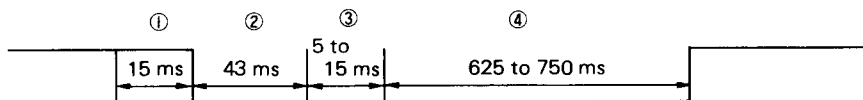

(iii) When key is held down over 0.5 second

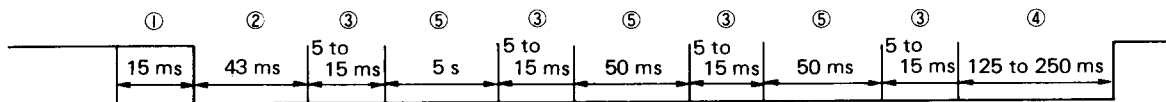

(If band edge appears during this operation, time ⑤ is 625 to 750 ms.)

(2) Manual up/down (rotary switch)

(i) Outside band edge

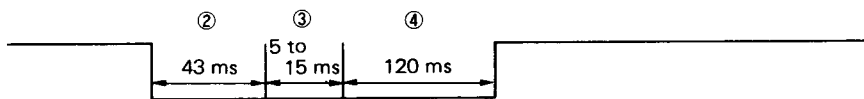

Note:

When the up/down switch is held down, time ③ may become longer.

(ii) Band edge (maximum frequency – minimum frequency)

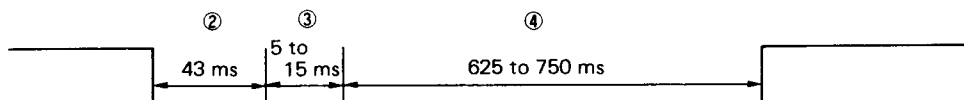

(3) Auto up/down

(i) When SD signal is input

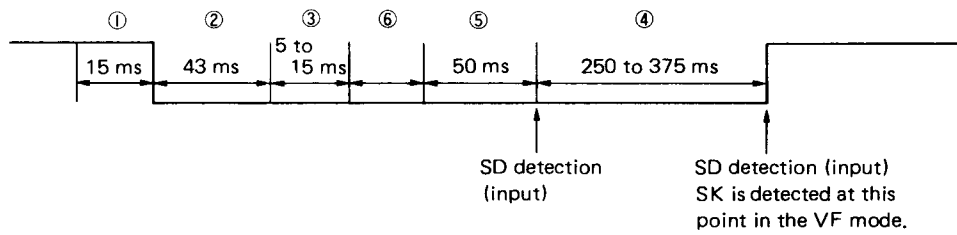

(ii) When SD signal is not input

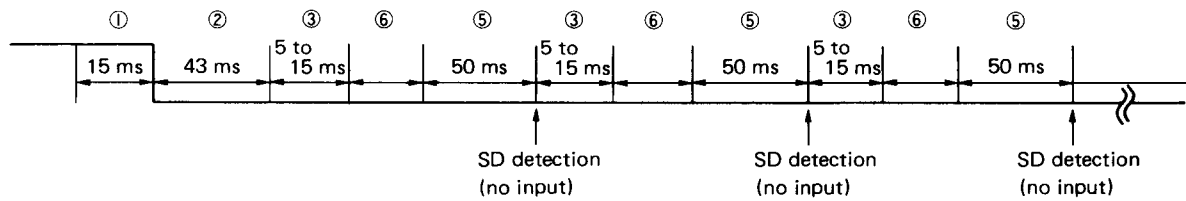

Note:

If band edge (maximum frequency ↔ minimum frequency) appears during this operation, time ⑤ is 375 to 500 ms.
Time ⑤ is 30 ms for European FM band.

(4) Preset memory recall

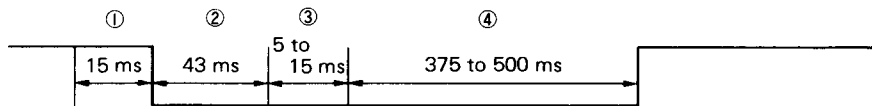

(5) Band switching

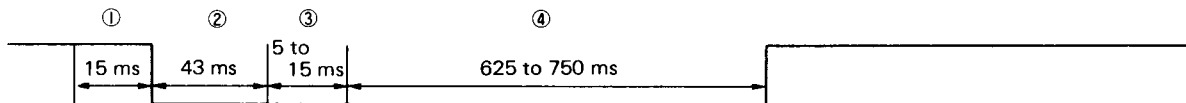

(6) Mode switching (radio OFF→ON), CE pin: Low→High

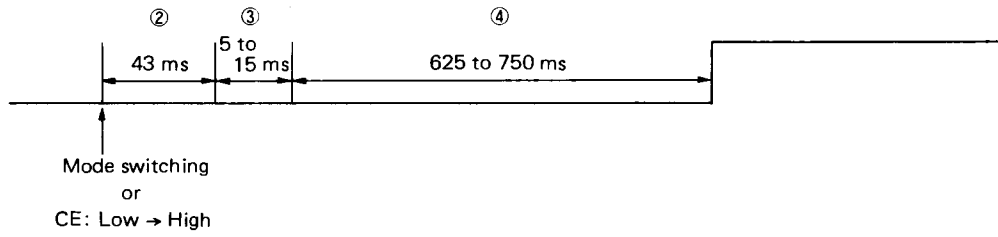

(7) Mode switching (radio ON→OFF), CE pin: High→Low

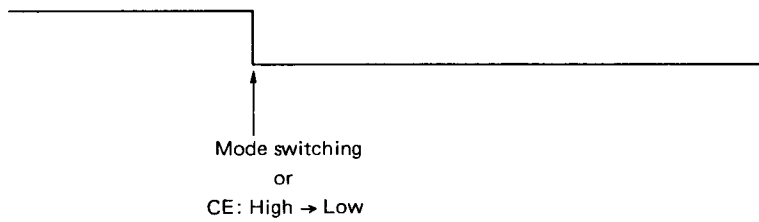

(8) VF mode switching (FM↔VF)

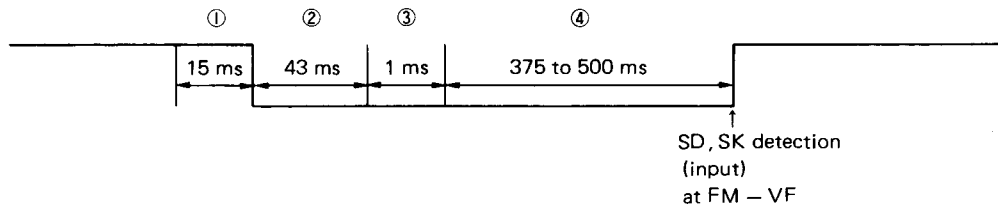

5. SOUTH AFRICAN FM BAND FREQUENCY TABLE

CHANNEL PLAN FREQUENCY	DISPLAY FREQUENCY	RECEIVED FREQUENCY	DIFFERENCE
87.604 MHz	87.60 MHz	87.60 MHz	-4 kHz
87.690	87.65	87.68	-10
87.776	87.75	87.78	4
87.862	87.85	87.86	-2
87.948	87.90	87.94	-8
88.034	88.00	88.04	6
88.120	88.10	88.12	0
88.206	88.20	88.20	-6
88.292	88.25	88.30	8
88.378	88.35	88.38	2
88.464	88.45	88.46	-4
88.550	88.55	88.54	-10
88.636	88.60	88.64	4
88.722	88.70	88.72	-2
88.808	88.80	88.80	-8
88.894	88.85	88.90	6
88.980	88.95	88.98	0
89.066	89.05	89.06	-6
89.152	89.15	89.16	8
89.238	89.20	89.24	2
89.324	89.30	89.32	-4
89.410	89.40	89.40	-10
89.496	89.45	89.50	4
89.582	89.55	89.58	-2
89.668	89.65	89.66	-8
89.754	89.75	89.76	6
89.840	89.80	89.84	0
89.926	89.90	89.92	-6
90.012	90.00	90.02	8
90.098	90.05	90.10	2
90.184	90.15	90.18	-4
90.270	90.25	90.26	-10
90.356	90.35	90.36	4
90.442	90.40	90.44	-2
90.528	90.50	90.52	-8
90.614	90.60	90.62	6
90.700	90.70	90.70	0
90.786	90.75	90.78	-6
90.872	90.85	90.88	8
90.958	90.95	90.96	2
91.044	91.00	91.04	-4
91.130	91.10	91.12	-10
91.216	91.20	91.22	4
91.302	91.30	91.30	-2
91.388	91.35	91.38	-8
91.474	91.45	91.48	6
91.560	91.55	91.56	0
91.646	91.60	91.64	-6
91.732	91.70	91.74	8
91.818	91.80	91.82	2

CHANNEL PLAN FREQUENCY	DISPLAY FREQUENCY	RECEIVED FREQUENCY	DIFFERENCE
91.904 MHz	91.90 MHz	91.90 MHz	-4 kHz
91.990	91.95	91.98	-10
92.076	92.05	92.08	4
92.162	92.15	92.16	-2
92.248	92.20	92.24	-8
92.334	92.30	92.34	6
92.420	92.40	92.42	0
92.506	92.50	92.50	-6
92.592	92.55	92.60	8
92.678	92.65	92.68	2
92.764	92.75	92.76	-4
92.850	92.85	92.84	-10
92.936	92.90	92.94	4
93.022	93.00	93.02	-2
93.108	93.10	93.10	-8
93.194	93.15	93.20	6
93.280	93.25	93.28	0
93.366	93.35	93.36	-6
93.452	93.45	93.46	8
93.538	93.50	92.54	2
93.624	93.60	93.62	-4
93.710	93.70	93.70	-10
93.796	93.75	93.80	4
93.882	93.85	93.88	-2
93.968	93.95	93.96	-8
94.054	94.05	94.06	6
94.140	94.10	94.14	0
94.226	94.20	94.22	-6
94.312	94.30	94.32	8
94.398	94.35	94.40	2
94.484	94.45	94.48	-4
94.570	94.55	94.56	-10
94.656	94.65	94.66	4
94.742	94.70	94.74	-2
94.828	94.80	94.82	-8
94.914	94.90	94.92	6
95.000	95.00	95.00	0
95.086	95.05	95.08	-6
95.172	95.15	95.18	8
95.258	95.25	95.26	2
95.344	95.30	95.34	-4
95.430	95.40	95.42	-10
95.516	95.50	95.52	4
95.602	95.60	95.60	-2
95.688	95.65	95.68	-8
95.774	95.75	95.78	6
95.860	95.85	95.86	0
95.946	95.90	95.94	-6
96.032	96.00	96.04	8
96.118	96.10	96.12	2

CHANNEL PLAN FREQUENCY	DISPLAY FREQUENCY	RECEIVED FREQUENCY	DIFFERENCE
96.204 MHz	96.20 MHz	96.20 MHz	-4 kHz
96.290	96.25	96.28	-10
96.376	96.35	96.38	4
96.462	96.45	96.46	-2
96.548	96.50	96.54	-8
96.634	96.60	96.64	6
96.720	96.70	96.72	0
96.806	96.80	96.80	-6
96.892	96.85	96.90	8
96.978	96.95	96.98	2
97.064	97.05	97.06	-4
97.150	97.15	97.14	-10
97.236	97.20	97.24	4
97.322	97.30	97.32	-2
97.408	97.40	97.40	-8
97.494	97.45	97.50	6
97.580	97.55	97.58	0
97.666	97.65	97.66	-6
97.752	97.75	97.76	8
97.838	97.80	97.84	2
97.924	97.90	97.92	-4
98.010	98.00	98.00	-10
98.096	98.05	98.10	4
98.182	98.15	98.18	-2
98.268	98.25	98.26	-8
98.354	98.35	98.36	6
98.440	98.40	98.44	0
98.526	98.50	98.52	-6
98.612	98.60	98.62	8
98.698	98.65	98.70	2
98.784	98.75	98.78	-4
98.870	98.85	98.86	-10
98.956	98.95	98.96	4
99.042	99.00	99.04	-2
99.128	99.10	99.12	-8
99.214	99.20	99.22	6
99.300	99.30	99.30	0
99.386	99.35	99.38	-6
99.472	99.45	99.48	8
99.558	99.55	99.56	2
99.644	99.60	99.64	-4
99.730	99.70	99.72	-10
99.816	99.80	99.82	4
99.902	99.90	99.90	-2
99.988	99.95	99.98	-8
100.074	100.05	100.08	6
100.160	100.15	100.16	0
100.246	100.20	100.24	-6
100.332	100.30	100.34	8
100.418	100.40	100.42	2

CHANNEL PLAN FREQUENCY	DISPLAY FREQUENCY	RECEIVED FREQUENCY	DIFFERENCE
100.504 MHz	100.50 MHz	100.50 MHz	-4 kHz
100.590	100.55	100.58	-10
100.676	100.65	100.68	4
100.762	100.75	100.76	-2
100.848	100.80	100.84	-8
100.934	100.90	100.94	6
101.020	101.00	101.02	0
101.106	101.10	101.10	-6
101.192	101.15	101.20	8
101.278	101.25	101.28	2
101.364	101.35	101.36	-4
101.450	101.45	101.44	-10
101.536	101.50	101.54	4
101.622	101.60	101.62	-2
101.708	101.70	101.70	-8
101.794	101.75	101.80	6
101.880	101.85	101.88	0
101.966	101.95	101.96	-6
102.052	102.05	102.06	8
102.138	102.10	102.14	2
102.224	102.20	102.22	-4
102.310	102.30	102.30	-10
102.396	102.35	102.40	4
102.482	102.45	102.48	-2
102.568	102.55	102.56	-8
102.654	102.65	102.66	6
102.740	102.70	102.74	0
102.826	102.80	102.82	-6
102.914	102.90	102.92	8
102.998	102.95	103.00	2
103.084	103.05	103.08	-4
103.170	103.15	103.16	-10
103.256	103.25	103.26	4
103.342	103.30	103.34	-2
103.428	103.40	103.42	-8
103.514	103.50	103.52	6
103.600	103.60	103.60	0
103.686	103.65	103.68	-6
103.772	103.75	103.78	8
103.858	103.85	103.86	2
103.944	103.90	103.94	-4
104.030	104.00	104.02	-10
104.116	104.10	104.12	4
104.202	104.20	104.20	-2
104.288	104.25	104.28	-8
104.374	104.35	104.38	6
104.460	104.45	104.46	0
104.546	104.50	104.54	-6
104.632	104.60	104.64	8
104.718	104.70	104.72	2

CHANNEL PLAN FREQUENCY	DISPLAY FREQUENCY	RECEIVED FREQUENCY	DIFFERENCE
104.804 MHz	104.80 MHz	104.80 MHz	-4 kHz
104.890	104.85	104.88	-10
104.976	104.95	104.98	4
105.062	105.05	105.06	-2
105.148	105.10	105.14	-8
105.234	105.20	105.24	6
105.320	105.30	105.32	0
105.406	105.40	105.40	-6
105.492	105.45	105.50	8
105.578	105.55	105.58	2
105.664	105.65	105.66	-4
105.750	105.75	105.74	-10
105.836	105.80	105.84	4
105.922	105.90	105.92	-2
106.008	106.00	106.00	-8
106.094	106.05	106.10	6
106.180	106.15	106.18	0
106.266	106.25	106.26	-6
106.352	106.35	106.36	8
106.438	106.40	106.44	2
106.524	106.50	106.52	-4
106.610	106.60	106.60	-10
106.696	106.65	106.70	4
106.782	106.75	106.78	-2
106.868	106.85	106.86	-8
106.954	106.95	106.96	6
107.040	107.00	107.04	0
107.126	107.10	107.12	-6
107.212	107.20	107.22	8
107.298	107.25	107.30	2
107.384	107.35	107.38	-4
107.470	107.45	107.46	-10
107.556	107.55	107.56	4
107.642	107.60	107.64	-2
107.728	107.70	107.72	-8
107.814	107.80	107.82	6
107.900	107.90	107.90	0
107.986	107.95	107.98	-6

APPLICATION CIRCUIT EXAMPLE

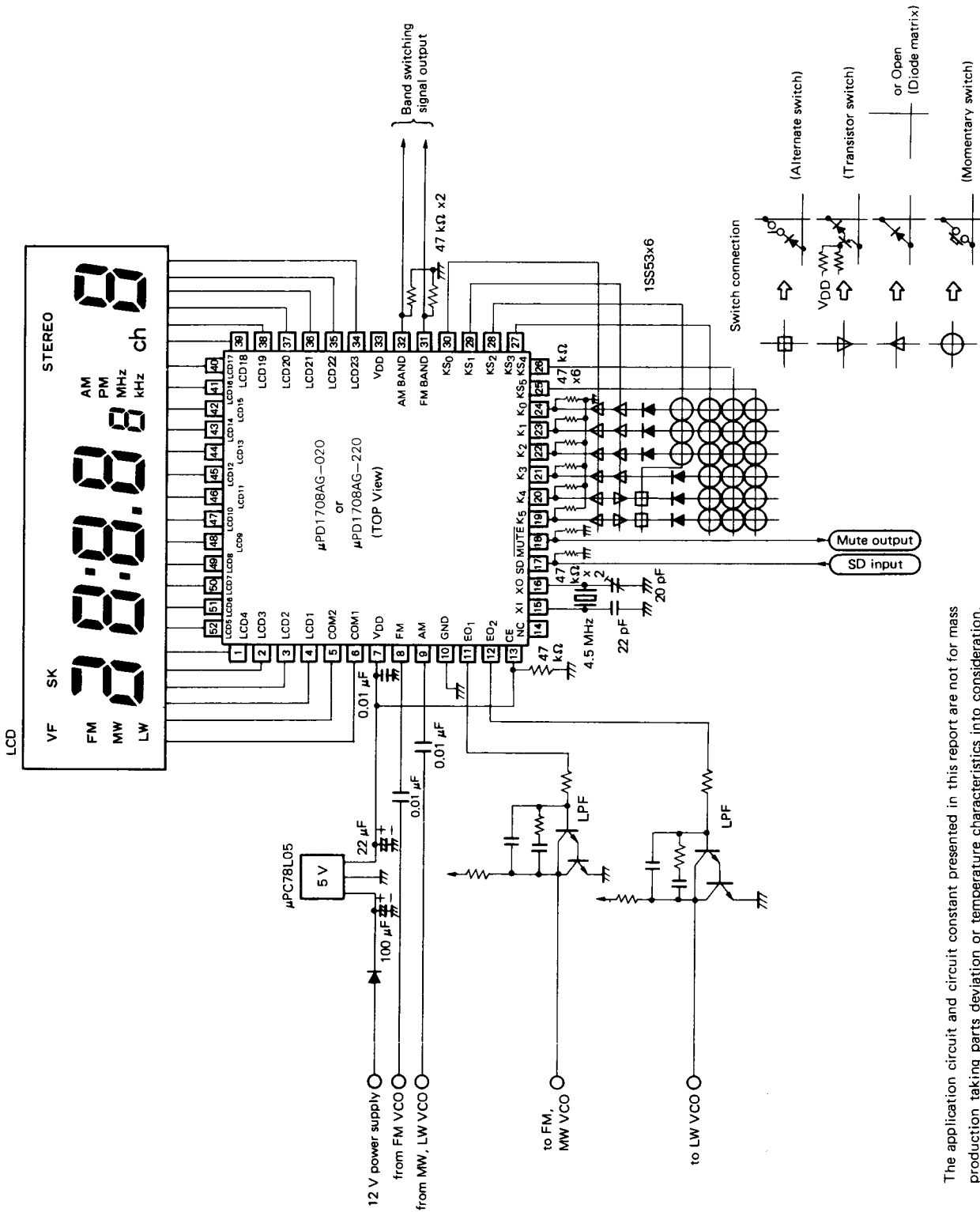

The application circuit and circuit constant presented in this report are not for mass production taking parts deviation or temperature characteristics into consideration. For patent regarding the circuits in this report, NEC does not bear any responsibility.

PACKAGE DIMENSIONS (Unit:mm)

μPD1708AG-020-00 (Lead bended type)

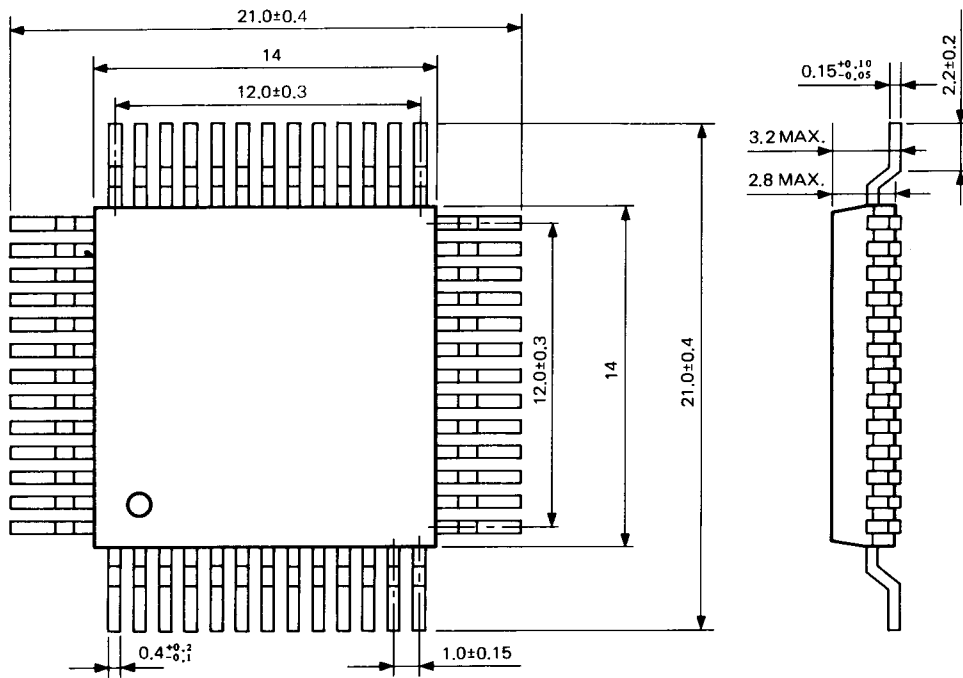

μPD1708AG-220-03 (Straight lead type)

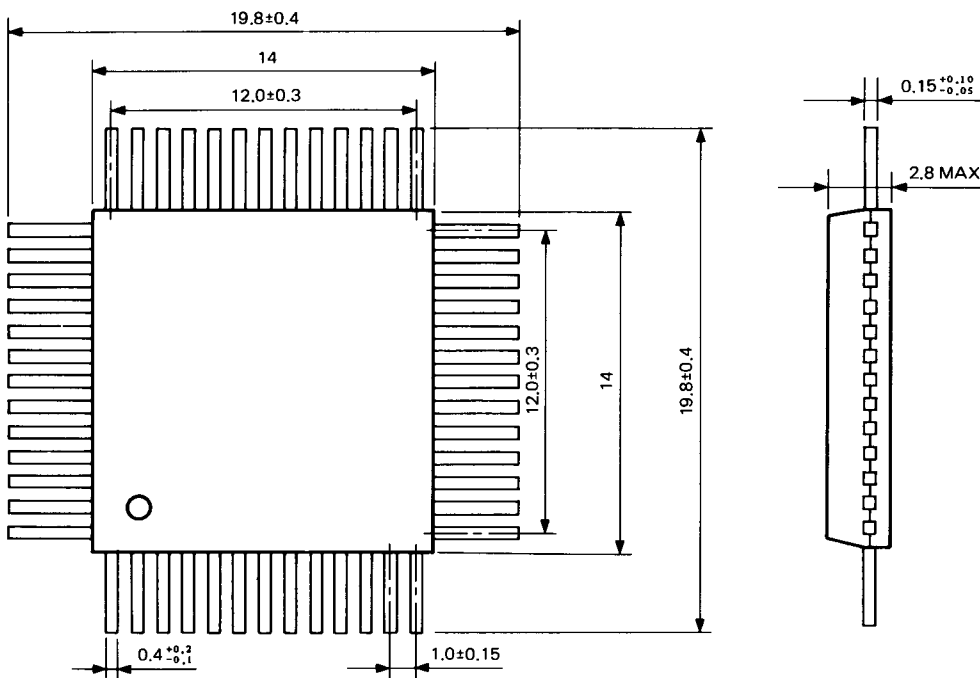

NEC Corporation

INTERNATIONAL ELECTRON DEVICES DIV.
 SUMITOMO MITA Building, 37-8,
 Shiba Gochome, Minato-ku, Tokyo 108, Japan
 Tel: Tokyo 456-3111
 Telex Address: NECTOK J22686
 Cable Address: NEC TOKYO