

**PLEASE CHECK WWW.MOLEX.COM FOR LATEST PART INFORMATION**

**Part Number:** [0009062069](#)  
**Status:** **Active**  
**Overview:** [kk](#)  
**Description:** 3.96mm (.156") KK® IDT Trifurcon™ Contact, 6 Circuits, Tin (Sn), Feed-Through, 20 Stranded, Blue ID Strip

**Documents:**

[3D Model](#) [Product Specification PS-7660 \(PDF\)](#)  
[Drawing \(PDF\)](#) [RoHS Certificate of Compliance \(PDF\)](#)

**General**

Product Family IDT and Solder Connectors  
 Series [7674](#)  
 Comments Trifurcon™ contact  
 Crimp Quality Equipment Yes  
 Overview [kk](#)  
 Product Name KK®, Trifurcon™

**Physical**

Circuits (Loaded) 6  
 Color - Resin Natural  
 Gender Female  
 Glow-Wire Compliant No  
 Lock to Mating Part Yes  
 Material - Metal Brass  
 Material - Plating Mating Tin  
 Material - Plating Termination Tin  
 Material - Resin Nylon  
 Number of Rows 1  
 Packaging Type Bag  
 Panel Mount No  
 Pitch - Mating Interface (in) 0.156 In  
 Pitch - Mating Interface (mm) 3.96 mm  
 Plating min: Mating (µin) 200  
 Plating min: Mating (µm) 5  
 Plating min: Termination (µin) 200  
 Plating min: Termination (µm) 5  
 Temperature Range - Operating 0°C to +75°C  
 Termination Interface: Style IDT or Pierce  
 Wire Size AWG 20 Stranded

**Electrical**

Voltage - Maximum 250V

**Material Info**

Old Part Number A-7674-B06L102A

**Reference - Drawing Numbers**

Packaging Specification PK-7674-001  
 Product Specification PS-7660  
 Sales Drawing SDA-7674-\*

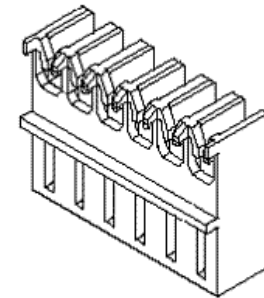

*Series  
image - Reference only*

**EU RoHS**

**ELV and RoHS  
Compliant**  
**REACH SVHC  
Contains SVHC: No  
Halogen-Free  
Status**

**China RoHS**



**Not Reviewed**

**Need more information on product  
environmental compliance?**

Email [productcompliance@molex.com](mailto:productcompliance@molex.com)  
 For a multiple part number RoHS Certificate of Compliance, [click here](#)

Please visit the [Contact Us](#) section for any non-product compliance questions.

**Search Parts in this Series**

[7674Series](#)

**Application Tooling | [FAQ](#)**

*Tooling specifications and manuals are found by selecting the products below. Crimp Height Specifications are then contained in the Application Tooling Specification document.*

**Global**

Description	Product #
Insertion Tool for 3.96mm (.156") Pitch KK® IDT Crimp Terminals	<a href="#">0638133503</a>
IDT - Manual Press For Ribbon Cable	<a href="#">0011200314</a>
IDT - Semi-automatic - Bench-Top Terminator	<a href="#">0011200418</a>
IDT - Manual Handtool	<a href="#">0011215196</a>
IDT Manual Handtool	<a href="#">0621000400</a>

IDT - Semi-automatic 0623000156  
- Bench-Top  
Terminator  
Arbor Press Fixture 0690200770

This document was generated on 05/27/2010

**PLEASE CHECK [WWW.MOLEX.COM](http://WWW.MOLEX.COM) FOR LATEST PART INFORMATION**

6

5

4

3

2

1

## HOUSING TYPE B

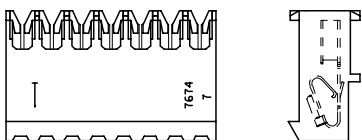

## HOUSING TYPE C

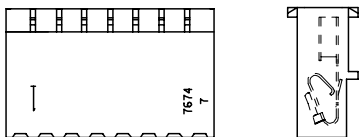

## HOUSING TYPE D

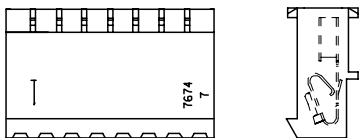

## NOTES:

- MATERIAL: HOUSING - UNFILLED NYLON, UL94V-2.  
TERMINAL - BRASS
- FINISH:
  - 102: .000200/(0.00508) MIN OVERALL TIN OVER  
.000100/(0.00254) MIN COPPER UNDERCOAT.
  - 154: .000100/(0.00254) MIN OVERALL TIN OVER  
.000050/(0.00127) MIN NICKEL UNDERCOAT.
  - 502: .000020/(0.00051) MIN OVERALL GOLD OVER  
.000050/(0.00127) MIN NICKEL UNDERCOAT.
  - 561: .000030/(0.00076) MIN SELECT GOLD OVER  
.000050/(0.00127) MIN NICKEL UNDERCOAT.
- PRODUCT SPECIFICATION: 7660
- PACKAGING: ALL PARTS ARE TO BE BULK PACKED PER PK-7674-001 UNLESS OTHERWISE SPECIFIED IN CHART.
- CHAIN CUTOFF: \*A\* DIMENSION PLUS .010/(0.25).
- COLOR STRIPE TO RUN LENGTH OF RIB AS SHOWN. SEE CHART FOR COLOR OF STRIPE.
- THIS PART CONFORMS TO CLASS B REQUIREMENTS OF COSMETIC SPECIFICATION PS-45499-002.

## HOUSING TYPE

A=7674-AN  
B=7674-BN  
C=7674-CN  
D=7674-DN

A-7674-\*N\*\*\*\*\*-\*  
NO. OF CKTS

## PULLED TERMINAL VOIDS

BLANK= NO VOIDS  
NO.= NUMBER CORRESPONDS  
TO CKT. NO. VOIDED,  
MULTIPLE VOIDS  
START WITH 5L

TERMINAL  
A=40936

PLATING  
SEE NOTE 2.

## SLOT SIZE

A= .029/(.74)  
M= .025/(.64)  
L= .022/(.56)  
D= .011/(.28)  
J= .015/(.38)

## HOUSING TYPE A

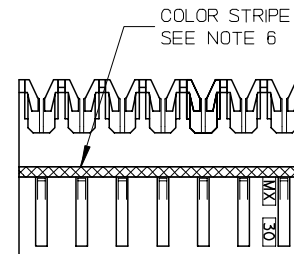
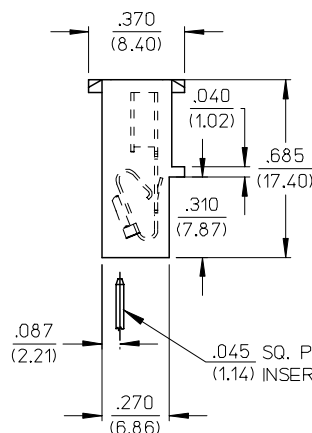
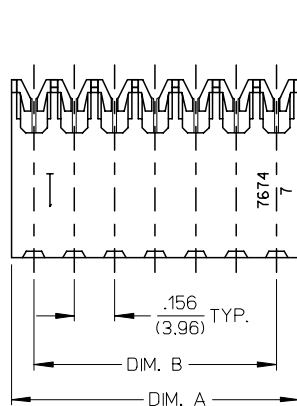

COLOR STRIPE  
SEE NOTE 6

COLOR IDENTIFICATION		TYPE OF WIRE TERMINATED (ALL WIRES HAVE A MAXIMUM INSULATION DIAMETER OF .095/(2.41))
SLOT SIZE	COLOR	
A	YELLOW	#18 GA. SOLID OR FUDED STRANDED
M	RED	#20 GA. SOLID OR FUDED STRANDED & #18 GA. STRANDED
L	BLUE	#20 GA. STRANDED WIRE
D	GREEN	#26 & #27 GA. STRANDED, FUDED STRANDED & SOLID WIRE OR #24 GA. STRANDED WIRE
J	BLACK	#24 & #22 GA. SOLID OR FUDED STRANDED & #22 GA. STRANDED

.156  
(3.96) TYP.  
DIM. B

.087  
(2.21)

.270  
(6.86)

.045 SQ. PIN  
(1.14) INSERTION DEPTH .450±.030/(11.43±0.76)

2-*	AC1	GEN DOCS
I	AC2	MICROSTATION
SHEET	REV	DOC STYLE

NO OF CKTS	DIM A	DIM B
2	.330±.007 (8.38±0.18)	.156±.006 (3.96±0.15)
3	.486±.007 (12.34±0.18)	.312±.006 (7.92±0.15)
4	.642±.007 (16.31±0.18)	.468±.006 (11.89±0.15)
5	.798±.008 (20.27±0.20)	.624±.007 (15.85±0.18)
6	.954±.008 (24.23±0.20)	.780±.007 (19.81±0.18)
7	1.110±.009 (28.19±0.23)	.936±.007 (23.77±0.18)
8	1.266±.009 (32.16±0.23)	1.092±.008 (27.74±0.20)
9	1.422±.009 (36.12±0.23)	1.248±.008 (31.70±0.20)
10	1.578±.010 (40.08±0.25)	1.404±.010 (35.66±0.25)
11	1.734±.010 (44.04±0.25)	1.560±.010 (39.62±0.25)
12	1.890±.010 (48.00±0.25)	1.716±.010 (43.59±0.25)
13	2.046±.011 (51.97±0.28)	1.872±.010 (47.55±0.25)
14	2.202±.011 (55.93±0.28)	2.028±.011 (51.51±0.28)
15	2.358±.011 (59.89±0.28)	2.184±.011 (55.47±0.28)
16	2.514±.011 (63.86±0.28)	2.340±.011 (59.44±0.28)

UPDATE DIM. A & B	DESCRIPTION
EC NO: UCP2007-1223	
DRWN:PRIDDER 2006/11/28	
CHKD:ADERR 2006/11/30	
APPR:FSMITH 2006/12/05	REV
AC2	

QUALITY SYMBOLS
▽=0
▽=0

GENERAL TOLERANCES (UNLESS SPECIFIED)	DIMENSION STYLE IN/MM	
	mm	INCH
4 PLACES	± ---	± ---
3 PLACES	± ---	±.010
2 PLACES	±0.25	±.014
1 PLACE	±0.36	± ---
ANGULAR ±1/2°		
DRAFT WHERE APPLICABLE MUST REMAIN WITHIN DIMENSIONS		

DRAWN BY	DATE
GUZIK	02/12/86
CHECKED BY	DATE
EDGLEY	02/12/86
APPROVED BY	DATE
LENZ	02/12/86
MATERIAL NO.	DOCUMENT NO.
SEE CHART	SDA-7674-*
SIZE	
A	

SCALE	DESIGN UNITS	THIRD ANGLE PROJECTION
---	METRIC	◎
TITLE .156 CENTER I.D.T. CONN. ASSY		
MOLEX INCORPORATED		
DOCUMENT NO.		SHEET NO.
SDA-7674-*		1 OF 12
THIS DRAWING CONTAINS INFORMATION THAT IS PROPRIETARY TO MOLEX INCORPORATED AND SHOULD NOT BE USED WITHOUT WRITTEN PERMISSION		

5

4

3

2

1

A-7674-ANA102A		A-7674-BNA102A		A-7674-CNA102A		A-7674-DNA102A	
HOUSING	7674-AN	HOUSING	7674-BN	HOUSING	7674-CN	HOUSING	7674-DN
TERM. NO	40936-A(102)	TERM. NO	40936-A(102)	TERM. NO	40936-A(102)	TERM. NO	40936-A(102)
PLATING:	102	PLATING:	102	PLATING:	102	PLATING:	102
COLOR	YELLOW	COLOR	YELLOW	COLOR	YELLOW	COLOR	YELLOW
MATL NO	ENG NO:	MATL NO	ENG NO:	MATL NO	ENG NO:	MATL NO	ENG NO:
09-07-0029	A-7674-A02A102A	09-06-0029	A-7674-B02A102A	09-07-0020	A-7674-C02A102A	09-06-0020	A-7674-D02A102A
09-07-0039	A-7674-A03A102A	09-06-0039	A-7674-B03A102A	09-07-0030	A-7674-C03A102A	09-06-0030	A-7674-D03A102A
09-07-0049	A-7674-A04A102A	09-06-0049	A-7674-B04A102A	09-07-0040	A-7674-C04A102A	09-06-0040	A-7674-D04A102A
09-07-0059	A-7674-A05A102A	09-06-0059	A-7674-B05A102A	09-07-0050	A-7674-C05A102A	09-06-0050	A-7674-D05A102A
09-07-0069	A-7674-A06A102A	09-06-0069	A-7674-B06A102A	09-07-0060	A-7674-C06A102A	09-06-0060	A-7674-D06A102A
09-07-0079	A-7674-A07A102A	09-06-0079	A-7674-B07A102A	09-07-0070	A-7674-C07A102A	09-06-0070	A-7674-D07A102A
09-07-0089	A-7674-A08A102A	09-06-0089	A-7674-B08A102A	09-07-0080	A-7674-C08A102A	09-06-0080	A-7674-D08A102A
09-07-0099	A-7674-A09A102A	09-06-0099	A-7674-B09A102A	09-07-0090	A-7674-C09A102A	09-06-0090	A-7674-D09A102A
09-07-0109	A-7674-A10A102A	09-06-0109	A-7674-B10A102A	09-07-0100	A-7674-C10A102A	09-06-0100	A-7674-D10A102A
09-07-0119	A-7674-A11A102A	09-06-0119	A-7674-B11A102A	09-07-0110	A-7674-C11A102A	09-06-0110	A-7674-D11A102A
09-07-0129	A-7674-A12A102A	09-06-0129	A-7674-B12A102A	09-07-0120	A-7674-C12A102A	09-06-0120	A-7674-D12A102A
09-07-0139	A-7674-A13A102A	09-06-0139	A-7674-B13A102A	09-07-0130	A-7674-C13A102A	09-06-0130	A-7674-D13A102A
09-07-0149	A-7674-A14A102A	09-06-0149	A-7674-B14A102A	09-07-0140	A-7674-C14A102A	09-06-0140	A-7674-D14A102A
09-07-0159	A-7674-A15A102A	09-06-0159	A-7674-B15A102A	09-07-0150	A-7674-C15A102A	09-06-0150	A-7674-D15A102A
09-07-0169	A-7674-A16A102A	09-06-0169	A-7674-B16A102A	09-07-0160	A-7674-C16A102A	09-06-0160	A-7674-D16A102A
						09-06-0032	A-7674-D03A102A-2
REVISION:	SEE SHEET 1 1/7/2005	TITLE: <b>KK 156 IDT CONNECTOR</b>				SHEET No. <b>2</b>	
DOCUMENT NUMBER:	<b>SDA-7674-*</b>	CREATED / REVISED BY:	<b>J.SCHAFFER 3-10-04</b>	CHECKED BY:	<b>K.SAMIEC 3-15-04</b>	APPROVED BY:	<b>MARGULIS 3-17-04</b>

A-7674-ANM102A		A-7674-BNM102A			A-7674-CNM102A		A-7674-DNM102A		
HOUSING	7674-AN	HOUSING	7674-BN		HOUSING	7674-CN	HOUSING	7674-DN	
TERM. NO	40936-M(102)	TERM. NO	40936-M(102)		TERM. NO	40936-M(102)	TERM. NO	40936-M(102)	
PLATING:	102	PLATING:	102		PLATING:	102	PLATING:	102	
COLOR	RED	COLOR	RED		COLOR	RED	COLOR	RED	
MATL NO	ENG NO:	MATL NO	ENG NO:	VOID	MATL NO	ENG NO:	MATL NO	ENG NO:	VOID
09-07-1029	A-7674-A02M102A	09-06-1029	A-7674-B02M102A		09-07-1020	A-7674-C02M102A	09-06-1020	A-7674-D02M102A	
09-07-1039	A-7674-A03M102A	09-06-1039	A-7674-B03M102A		09-07-1030	A-7674-C03M102A	09-06-1030	A-7674-D03M102A	
09-07-1049	A-7674-A04M102A	09-06-1049	A-7674-B04M102A		09-07-1040	A-7674-C04M102A	09-06-1040	A-7674-D04M102A	
09-07-1059	A-7674-A05M102A	09-06-1059	A-7674-B05M102A		09-07-1050	A-7674-C05M102A	09-06-1050	A-7674-D05M102A	
09-07-1069	A-7674-A06M102A	09-06-1069	A-7674-B06M102A		09-07-1060	A-7674-C06M102A	09-06-1060	A-7674-D06M102A	
09-07-1079	A-7674-A07M102A	09-06-1079	A-7674-B07M102A		09-07-1070	A-7674-C07M102A	09-06-1070	A-7674-D07M102A	
09-07-1089	A-7674-A08M102A	09-06-1089	A-7674-B08M102A		09-07-1080	A-7674-C08M102A	09-06-1080	A-7674-D08M102A	
09-07-1099	A-7674-A09M102A	09-06-1099	A-7674-B09M102A		09-07-1090	A-7674-C09M102A	09-06-1090	A-7674-D09M102A	
09-07-1109	A-7674-A10M102A	09-06-1109	A-7674-B10M102A		09-07-1100	A-7674-C10M102A	09-06-1100	A-7674-D10M102A	
09-07-1119	A-7674-A11M102A	09-06-1119	A-7674-B11M102A		09-07-1110	A-7674-C11M102A	09-06-1110	A-7674-D11M102A	
09-07-1129	A-7674-A12M102A	09-06-1129	A-7674-B12M102A		09-07-1120	A-7674-C12M102A	09-06-1120	A-7674-D12M102A	
09-07-1139	A-7674-A13M102A	09-06-1139	A-7674-B13M102A		09-07-1130	A-7674-C13M102A	09-06-1130	A-7674-D13M102A	
09-07-1149	A-7674-A14M102A	09-06-1149	A-7674-B14M102A		09-07-1140	A-7674-C14M102A	09-06-1140	A-7674-D14M102A	
09-07-1159	A-7674-A15M102A	09-06-1159	A-7674-B15M102A		09-07-1150	A-7674-C15M102A	09-06-1150	A-7674-D15M102A	
09-07-1169	A-7674-A16M102A	09-06-1169	A-7674-B16M102A		09-07-1160	A-7674-C16M102A	09-06-1160	A-7674-D16M102A	
		50-29-1592	A-7674-B03M102A-2	2			50-29-1591	A-7674-D03M102A-2	2

REVISION: <b>AC1</b>	<b>SEE SHEET 1 1/7/2005</b>	TITLE: <b>KK 156 IDT CONNECTOR</b>	SHEET No. <b>3</b>
DOCUMENT NUMBER: <b>SDA-7674-*</b>	CREATED / REVISED BY: <b>J.SCHAFFER 3-10-04</b>	CHECKED BY: <b>K.SAMIEC 3-15-04</b>	APPROVED BY: <b>MARGULIS 3-17-04</b>

A-7674-ANL102A		A-7674-BNL102A		A-7674-CNL102A		A-7674-DNL102A		
HOUSING	7674-AN	HOUSING	7674-BN	HOUSING	7674-CN	HOUSING	7674-DN	
TERM. NO	40936-L(102)	TERM. NO	40936-L(102)	TERM. NO	40936-L(102)	TERM. NO	40936-L(102)	
PLATING:	102	PLATING:	102	PLATING:	102	PLATING:	102	
COLOR	BLUE	COLOR	BLUE	COLOR	BLUE	COLOR	BLUE	
MATL NO	ENG NO:	MATL NO	ENG NO:	MATL NO	ENG NO:	MATL NO	ENG NO:	
09-07-2029	A-7674-A02L102A	09-06-2029	A-7674-B02L102A	09-07-2020	A-7674-C02L102A	09-06-2020	A-7674-D02L102A	
09-07-2039	A-7674-A03L102A	09-06-2039	A-7674-B03L102A	09-07-2030	A-7674-C03L102A	09-06-2030	A-7674-D03L102A	
09-07-2049	A-7674-A04L102A	09-06-2049	A-7674-B04L102A	09-07-2040	A-7674-C04L102A	09-06-2040	A-7674-D04L102A	
09-07-2059	A-7674-A05L102A	09-06-2059	A-7674-B05L102A	09-07-2050	A-7674-C05L102A	09-06-2050	A-7674-D05L102A	
09-07-2069	A-7674-A06L102A	09-06-2069	A-7674-B06L102A	09-07-2060	A-7674-C06L102A	09-06-2060	A-7674-D06L102A	
09-07-2079	A-7674-A07L102A	09-06-2079	A-7674-B07L102A	09-07-2070	A-7674-C07L102A	09-06-2070	A-7674-D07L102A	
09-07-2089	A-7674-A08L102A	09-06-2089	A-7674-B08L102A	09-07-2080	A-7674-C08L102A	09-06-2080	A-7674-D08L102A	
09-07-2099	A-7674-A09L102A	09-06-2099	A-7674-B09L102A	09-07-2090	A-7674-C09L102A	09-06-2090	A-7674-D09L102A	
09-07-2109	A-7674-A10L102A	09-06-2109	A-7674-B10L102A	09-07-2100	A-7674-C10L102A	09-06-2100	A-7674-D10L102A	
09-07-2119	A-7674-A11L102A	09-06-2119	A-7674-B11L102A	09-07-2110	A-7674-C11L102A	09-06-2110	A-7674-D11L102A	
09-07-2129	A-7674-A12L102A	09-06-2129	A-7674-B12L102A	09-07-2120	A-7674-C12L102A	09-06-2120	A-7674-D12L102A	
09-07-2139	A-7674-A13L102A	09-06-2139	A-7674-B13L102A	09-07-2130	A-7674-C13L102A	09-06-2130	A-7674-D13L102A	
09-07-2149	A-7674-A14L102A	09-06-2149	A-7674-B14L102A	09-07-2140	A-7674-C14L102A	09-06-2140	A-7674-D14L102A	
09-07-2159	A-7674-A15L102A	09-06-2159	A-7674-B15L102A	09-07-2150	A-7674-C15L102A	09-06-2150	A-7674-D15L102A	
09-07-2169	A-7674-A16L102A	09-06-2169	A-7674-B16L102A	09-07-2160	A-7674-C16L102A	09-06-2160	A-7674-D16L102A	
REVISION:	<b>SEE SHEET 1</b> 1/7/2005	TITLE:	<b>KK 156 IDT CONNECTOR</b>				SHEET No.	
<b>AC1</b>							<b>4</b>	
DOCUMENT NUMBER:		CREATED / REVISED BY:	CHECKED BY:	APPROVED BY:				
<b>SDA-7674-*</b>		<b>J.SCHAFFER 3-10-04</b>	<b>K.SAMIEC 3-15-04</b>	<b>MARGULIS 3-17-04</b>				

A-7674-AND102A		A-7674-BND102A		A-7674-CND102A		A-7674-DND102A		
HOUSING	7674-AN	HOUSING	7674-BN	HOUSING	7674-CN	HOUSING	7674-DN	
TERM. NO	40936-D(102)	TERM. NO	40936-D(102)	TERM. NO	40936-D(102)	TERM. NO	40936-D(102)	
PLATING:	102	PLATING:	102	PLATING:	102	PLATING:	102	
COLOR	GREEN	COLOR	GREEN	COLOR	GREEN	COLOR	GREEN	
MATL NO	ENG NO:	MATL NO	ENG NO:	MATL NO	ENG NO:	MATL NO	ENG NO:	
09-07-3029	A-7674-A02D102A	09-06-3029	A-7674-B02D102A	09-07-3020	A-7674-C02D102A	09-06-3020	A-7674-D02D102A	
09-07-3039	A-7674-A03D102A	09-06-3039	A-7674-B03D102A	09-07-3030	A-7674-C03D102A	09-06-3030	A-7674-D03D102A	
09-07-3049	A-7674-A04D102A	09-06-3049	A-7674-B04D102A	09-07-3040	A-7674-C04D102A	09-06-3040	A-7674-D04D102A	
09-07-3059	A-7674-A05D102A	09-06-3059	A-7674-B05D102A	09-07-3050	A-7674-C05D102A	09-06-3050	A-7674-D05D102A	
09-07-3069	A-7674-A06D102A	09-06-3069	A-7674-B06D102A	09-07-3060	A-7674-C06D102A	09-06-3060	A-7674-D06D102A	
09-07-3079	A-7674-A07D102A	09-06-3079	A-7674-B07D102A	09-07-3070	A-7674-C07D102A	09-06-3070	A-7674-D07D102A	
09-07-3089	A-7674-A08D102A	09-06-3089	A-7674-B08D102A	09-07-3080	A-7674-C08D102A	09-06-3080	A-7674-D08D102A	
09-07-3099	A-7674-A09D102A	09-06-3099	A-7674-B09D102A	09-07-3090	A-7674-C09D102A	09-06-3090	A-7674-D09D102A	
09-07-3109	A-7674-A10D102A	09-06-3109	A-7674-B10D102A	09-07-3100	A-7674-C10D102A	09-06-3100	A-7674-D10D102A	
09-07-3119	A-7674-A11D102A	09-06-3119	A-7674-B11D102A	09-07-3110	A-7674-C11D102A	09-06-3110	A-7674-D11D102A	
09-07-3129	A-7674-A12D102A	09-06-3129	A-7674-B12D102A	09-07-3120	A-7674-C12D102A	09-06-3120	A-7674-D12D102A	
09-07-3139	A-7674-A13D102A	09-06-3139	A-7674-B13D102A	09-07-3130	A-7674-C13D102A	09-06-3130	A-7674-D13D102A	
09-07-3149	A-7674-A14D102A	09-06-3149	A-7674-B14D102A	09-07-3140	A-7674-C14D102A	09-06-3140	A-7674-D14D102A	
09-07-3159	A-7674-A15D102A	09-06-3159	A-7674-B15D102A	09-07-3150	A-7674-C15D102A	09-06-3150	A-7674-D15D102A	
09-07-3169	A-7674-A16D102A	09-06-3169	A-7674-B16D102A	09-07-3160	A-7674-C16D102A	09-06-3160	A-7674-D16D102A	
REVISION:	<b>SEE SHEET 1</b> 1/7/2005	TITLE:	<b>KK 156 IDT CONNECTOR</b>				SHEET No. <b>5</b>	
<b>AC1</b>								
DOCUMENT NUMBER:		CREATED / REVISED BY:	CHECKED BY:	APPROVED BY:				
<b>SDA-7674-*</b>		<b>J.SCHAFFER 3-10-04</b>	<b>K.SAMIEC 3-15-04</b>	<b>MARGULIS 3-17-04</b>				

A-7674-ANJ102A		A-7674-BNJ102A		A-7674-CNJ102A			A-7674-DNJ102A	
HOUSING	7674-AN	HOUSING	7674-BN	HOUSING	7674-CN		HOUSING	7674-DN
TERM. NO	40936-J(102)	TERM. NO	40936-J(102)	TERM. NO	40936-J(102)		TERM. NO	40936-J(102)
PLATING:	102	PLATING:	102	PLATING:	102		PLATING:	102
COLOR	BLACK	COLOR	BLACK	COLOR	BLACK		COLOR	BLACK
MATL NO	ENG NO:	MATL NO	ENG NO:	MATL NO	ENG NO:	VOID	MATL NO	ENG NO:
09-07-5029	A-7674-A02J102A	09-06-5029	A-7674-B02J102A	09-07-5020	A-7674-C02J102A		09-06-5020	A-7674-D02J102A
09-07-5039	A-7674-A03J102A	09-06-5039	A-7674-B03J102A	09-07-5030	A-7674-C03J102A		09-06-5030	A-7674-D03J102A
09-07-5049	A-7674-A04J102A	09-06-5049	A-7674-B04J102A	09-07-5040	A-7674-C04J102A		09-06-5040	A-7674-D04J102A
09-07-5059	A-7674-A05J102A	09-06-5059	A-7674-B05J102A	09-07-5050	A-7674-C05J102A		09-06-5050	A-7674-D05J102A
09-07-5069	A-7674-A06J102A	09-06-5069	A-7674-B06J102A	09-07-5060	A-7674-C06J102A		09-06-5060	A-7674-D06J102A
09-07-5079	A-7674-A07J102A	09-06-5079	A-7674-B07J102A	09-07-5070	A-7674-C07J102A		09-06-5070	A-7674-D07J102A
09-07-5089	A-7674-A08J102A	09-06-5089	A-7674-B08J102A	09-07-5080	A-7674-C08J102A		09-06-5080	A-7674-D08J102A
09-07-5099	A-7674-A09J102A	09-06-5099	A-7674-B09J102A	09-07-5090	A-7674-C09J102A		09-06-5090	A-7674-D09J102A
09-07-5109	A-7674-A10J102A	09-06-5109	A-7674-B10J102A	09-07-5100	A-7674-C10J102A		09-06-5100	A-7674-D10J102A
09-07-5119	A-7674-A11J102A	09-06-5119	A-7674-B11J102A	09-07-5110	A-7674-C11J102A		09-06-5110	A-7674-D11J102A
09-07-5129	A-7674-A12J102A	09-06-5129	A-7674-B12J102A	09-07-5120	A-7674-C12J102A		09-06-5120	A-7674-D12J102A
09-07-5139	A-7674-A13J102A	09-06-5139	A-7674-B13J102A	09-07-5130	A-7674-C13J102A		09-06-5130	A-7674-D13J102A
09-07-5149	A-7674-A14J102A	09-06-5149	A-7674-B14J102A	09-07-5140	A-7674-C14J102A		09-06-5140	A-7674-D14J102A
09-07-5159	A-7674-A15J102A	09-06-5159	A-7674-B15J102A	09-07-5150	A-7674-C15J102A		09-06-5150	A-7674-D15J102A
09-07-5169	A-7674-A16J102A	09-06-5169	A-7674-B16J102A	09-07-5160	A-7674-C16J102A		09-06-5160	A-7674-D16J102A
				09-10-2156	A-7674-C15J102A-51	2,4,6,8, 10,12, 14		
				09-10-2117	A-7674-C11J102A-51	2,4,6,8, 10		
REVISION:	<b>AC1</b>	TITLE:	<b>KK 156 IDT CONNECTOR</b>				SHEET No.	<b>6</b>
		<b>SEE SHEET 1 1/7/2005</b>						
DOCUMENT NUMBER:	<b>SDA-7674-*</b>	CREATED / REVISED BY:	<b>J.SCHAFFER 3-10-04</b>	CHECKED BY:	<b>K.SAMIEC 3-15-04</b>	APPROVED BY:	<b>MARGULIS 3-17-04</b>	



A-7674-ANA502A		A-7674-BNA502A		A-7674-CNA502A		A-7674-DNA502A		
HOUSING	7674-AN	HOUSING	7674-BN	HOUSING	7674-CN	HOUSING	7674-DN	
TERM. NO	40936-A(502)	TERM. NO	40936-A(502)	TERM. NO	40936-A(502)	TERM. NO	40936-A(502)	
PLATING:	502	PLATING:	502	PLATING:	502	PLATING:	502	
COLOR	YELLOW	COLOR	YELLOW	COLOR	YELLOW	COLOR	YELLOW	
MATL NO	ENG NO:	MATL NO	ENG NO:	MATL NO	ENG NO:	MATL NO	ENG NO:	
	A-7674-A02A502A		A-7674-B02A502A		A-7674-C02A502A	26-32-4024	A-7674-D02A502A	
	A-7674-A03A502A		A-7674-B03A502A		A-7674-C03A502A	26-32-4034	A-7674-D03A502A	
	A-7674-A04A502A		A-7674-B04A502A		A-7674-C04A502A	26-32-4044	A-7674-D04A502A	
	A-7674-A05A502A		A-7674-B05A502A		A-7674-C05A502A	26-32-4054	A-7674-D05A502A	
	A-7674-A06A502A		A-7674-B06A502A		A-7674-C06A502A	26-32-4064	A-7674-D06A502A	
	A-7674-A07A502A		A-7674-B07A502A		A-7674-C07A502A	26-32-4074	A-7674-D07A502A	
	A-7674-A08A502A		A-7674-B08A502A		A-7674-C08A502A	26-32-4084	A-7674-D08A502A	
	A-7674-A09A502A		A-7674-B09A502A		A-7674-C09A502A	26-32-4094	A-7674-D09A502A	
	A-7674-A10A502A		A-7674-B10A502A		A-7674-C10A502A	26-32-4104	A-7674-D10A502A	
	A-7674-A11A502A		A-7674-B11A502A		A-7674-C11A502A	26-32-4114	A-7674-D11A502A	
	A-7674-A12A502A		A-7674-B12A502A		A-7674-C12A502A	26-32-4124	A-7674-D12A502A	
	A-7674-A13A502A		A-7674-B13A502A		A-7674-C13A502A	26-32-4134	A-7674-D13A502A	
	A-7674-A14A502A		A-7674-B14A502A		A-7674-C14A502A	26-32-4144	A-7674-D14A502A	
	A-7674-A15A502A		A-7674-B15A502A		A-7674-C15A502A	26-32-4154	A-7674-D15A502A	
	A-7674-A16A502A		A-7674-B16A502A		A-7674-C16A502A	26-32-4164	A-7674-D16A502A	
REVISION:	SEE SHEET 1 1/7/2005		TITLE:  KK 156 IDT CONNECTOR				SHEET No.  7	
DOCUMENT NUMBER:	SDA-7674-*		CREATED / REVISED BY:	J.SCHAFFER 3-10-04		CHECKED BY:	K.SAMIEC 3-15-04	
						APPROVED BY:	MARGULIS 3-17-04	

A-7674-ANM502A		A-7674-BNM502A		A-7674-CNM502A		A-7674-DNM502A		
HOUSING	7674-AN	HOUSING	7674-BN	HOUSING	7674-CN	HOUSING	7674-DN	
TERM. NO	40936-M(502)	TERM. NO	40936-M(502)	TERM. NO	40936-M(502)	TERM. NO	40936-M(502)	
PLATING:	502	PLATING:	502	PLATING:	502	PLATING:	502	
COLOR	RED	COLOR	RED	COLOR	RED	COLOR	RED	
MATL NO	ENG NO:	MATL NO	ENG NO:	MATL NO	ENG NO:	MATL NO	ENG NO:	
	A-7674-A02M502A		A-7674-B02M502A		A-7674-C02M502A		A-7674-D02M502A	
	A-7674-A03M502A		A-7674-B03M502A		A-7674-C03M502A	26-32-6034	A-7674-D03M502A	
	A-7674-A04M502A		A-7674-B04M502A		A-7674-C04M502A	26-32-6044	A-7674-D04M502A	
	A-7674-A05M502A		A-7674-B05M502A		A-7674-C05M502A		A-7674-D05M502A	
	A-7674-A06M502A		A-7674-B06M502A		A-7674-C06M502A	26-32-6064	A-7674-D06M502A	
	A-7674-A07M502A		A-7674-B07M502A		A-7674-C07M502A	26-32-6074	A-7674-D07M502A	
	A-7674-A08M502A		A-7674-B08M502A		A-7674-C08M502A		A-7674-D08M502A	
	A-7674-A09M502A		A-7674-B09M502A		A-7674-C09M502A		A-7674-D09M502A	
	A-7674-A10M502A		A-7674-B10M502A		A-7674-C10M502A	26-32-6104	A-7674-D10M502A	
	A-7674-A11M502A	26-32-4111	A-7674-B11M502A		A-7674-C11M502A		A-7674-D11M502A	
	A-7674-A12M502A		A-7674-B12M502A		A-7674-C12M502A		A-7674-D12M502A	
	A-7674-A13M502A		A-7674-B13M502A		A-7674-C13M502A		A-7674-D13M502A	
	A-7674-A14M502A		A-7674-B14M502A		A-7674-C14M502A		A-7674-D14M502A	
	A-7674-A15M502A		A-7674-B15M502A		A-7674-C15M502A		A-7674-D15M502A	
	A-7674-A16M502A		A-7674-B16M502A		A-7674-C16M502A		A-7674-D16M502A	
REVISION:	<b>AC1</b>	TITLE:	<b>KK 156 IDT CONNECTOR</b>				SHEET No.	<b>8</b>
DOCUMENT NUMBER:	<b>SDA-7674-*</b>	CREATED / REVISED BY:	<b>J.SCHAFFER 3-10-04</b>	CHECKED BY:	<b>K.SAMIEC 3-15-04</b>	APPROVED BY:	<b>MARGULIS 3-17-04</b>	

A-7674-ANL502A		A-7674-BNL502A		A-7674-CNL502A		A-7674-DNL502A	
HOUSING	7674-AN	HOUSING	7674-BN	HOUSING	7674-CN	HOUSING	7674-DN
TERM. NO	40936-L(502)	TERM. NO	40936-L(502)	TERM. NO	40936-L(502)	TERM. NO	40936-L(502)
PLATING:	502	PLATING:	502	PLATING:	502	PLATING:	502
COLOR	BLUE	COLOR	BLUE	COLOR	BLUE	COLOR	BLUE
MATL NO	ENG NO:	MATL NO	ENG NO:	MATL NO	ENG NO:	MATL NO	ENG NO:
26-32-2024	A-7674-A02L502A		A-7674-B02L502A		A-7674-C02L502A	26-32-2022	A-7674-D02L502A
26-32-2034	A-7674-A03L502A		A-7674-B03L502A		A-7674-C03L502A	26-32-2032	A-7674-D03L502A
26-32-2044	A-7674-A04L502A		A-7674-B04L502A		A-7674-C04L502A	26-32-2042	A-7674-D04L502A
26-32-2054	A-7674-A05L502A		A-7674-B05L502A		A-7674-C05L502A	26-32-2052	A-7674-D05L502A
26-32-2064	A-7674-A06L502A		A-7674-B06L502A		A-7674-C06L502A	26-32-2062	A-7674-D06L502A
26-32-2074	A-7674-A07L502A		A-7674-B07L502A		A-7674-C07L502A	26-32-2072	A-7674-D07L502A
26-32-2084	A-7674-A08L502A		A-7674-B08L502A		A-7674-C08L502A	26-32-2082	A-7674-D08L502A
26-32-2094	A-7674-A09L502A		A-7674-B09L502A		A-7674-C09L502A	26-32-2092	A-7674-D09L502A
26-32-2104	A-7674-A10L502A		A-7674-B10L502A		A-7674-C10L502A	26-32-2102	A-7674-D10L502A
26-32-2114	A-7674-A11L502A		A-7674-B11L502A		A-7674-C11L502A	26-32-2112	A-7674-D11L502A
26-32-2124	A-7674-A12L502A		A-7674-B12L502A		A-7674-C12L502A	26-32-2122	A-7674-D12L502A
26-32-2134	A-7674-A13L502A		A-7674-B13L502A		A-7674-C13L502A	26-32-2132	A-7674-D13L502A
26-32-2144	A-7674-A14L502A		A-7674-B14L502A		A-7674-C14L502A	26-32-2142	A-7674-D14L502A
26-32-2154	A-7674-A15L502A		A-7674-B15L502A		A-7674-C15L502A	26-32-2152	A-7674-D15L502A
26-32-2164	A-7674-A16L502A		A-7674-B16L502A		A-7674-C16L502A	26-32-2162	A-7674-D16L502A

REVISION:	<b>SEE SHEET 1</b> 1/7/2005	TITLE:	<b>KK 156 IDT CONNECTOR</b>	SHEET No.	<b>9</b>
DOCUMENT NUMBER:	<b>SDA-7674-*</b>	CREATED / REVISED BY:	<b>J.SCHAFFER 3-10-04</b>	CHECKED BY:	<b>K.SAMIEC 3-15-04</b>
				APPROVED BY:	<b>MARGULIS 3-17-04</b>

A-7674-ANJ502A		A-7674-BNJ502A		A-7674-CNJ502A		A-7674-DNJ502A		
HOUSING	7674-AN	HOUSING	7674-BN	HOUSING	7674-CN	HOUSING	7674-DN	
TERM. NO	40936-J(502)	TERM. NO	40936-J(502)	TERM. NO	40936-J(502)	TERM. NO	40936-J(502)	
PLATING:	502	PLATING:	502	PLATING:	502	PLATING:	502	
COLOR	BLACK	COLOR	BLACK	COLOR	BLACK	COLOR	BLACK	
MATL NO	ENG NO:	MATL NO	ENG NO:	MATL NO	ENG NO:	MATL NO	ENG NO:	
	A-7674-A02J502A	26-32-1027	A-7674-B02J502A		A-7674-C02J502A	26-32-1025	A-7674-D02J502A	
	A-7674-A03J502A	26-32-1037	A-7674-B03J502A		A-7674-C03J502A	26-32-1035	A-7674-D03J502A	
	A-7674-A04J502A	26-32-1047	A-7674-B04J502A		A-7674-C04J502A	26-32-1049	A-7674-D04J502A	
	A-7674-A05J502A	26-32-1057	A-7674-B05J502A		A-7674-C05J502A	26-32-1059	A-7674-D05J502A	
	A-7674-A06J502A	26-32-1067	A-7674-B06J502A	26-32-1063	A-7674-C06J502A	26-32-1069	A-7674-D06J502A	
	A-7674-A07J502A	26-32-1077	A-7674-B07J502A		A-7674-C07J502A	26-32-1079	A-7674-D07J502A	
	A-7674-A08J502A	26-32-1087	A-7674-B08J502A		A-7674-C08J502A	26-32-1089	A-7674-D08J502A	
	A-7674-A09J502A	26-32-1097	A-7674-B09J502A		A-7674-C09J502A	26-32-1099	A-7674-D09J502A	
	A-7674-A10J502A	26-32-1107	A-7674-B10J502A		A-7674-C10J502A	26-32-1109	A-7674-D10J502A	
	A-7674-A11J502A	26-32-1117	A-7674-B11J502A		A-7674-C11J502A	26-32-1119	A-7674-D11J502A	
	A-7674-A12J502A	26-32-1127	A-7674-B12J502A		A-7674-C12J502A	26-32-1129	A-7674-D12J502A	
	A-7674-A13J502A	26-32-1137	A-7674-B13J502A		A-7674-C13J502A	26-32-1139	A-7674-D13J502A	
	A-7674-A14J502A	26-32-1147	A-7674-B14J502A		A-7674-C14J502A	26-32-1149	A-7674-D14J502A	
	A-7674-A15J502A	26-32-1157	A-7674-B15J502A		A-7674-C15J502A	26-32-1159	A-7674-D15J502A	
	A-7674-A16J502A	26-32-1167	A-7674-B16J502A		A-7674-C16J502A	26-32-1169	A-7674-D16J502A	
REVISION:	<b>AC1</b>	TITLE:	<b>KK 156 IDT CONNECTOR</b>				SHEET No.	<b>10</b>
		<b>SEE SHEET 1 1/7/2005</b>						
DOCUMENT NUMBER:	<b>SDA-7674-*</b>	CREATED / REVISED BY:	<b>J.SCHAFFER 3-10-04</b>	CHECKED BY:	<b>K.SAMIEC 3-15-04</b>	APPROVED BY:	<b>MARGULIS 3-17-04</b>	

A-7674-ANJ561A		A-7674-BNJ561A		A-7674-CNJ561A		A-7674-DNJ561A		
HOUSING	7674-AN	HOUSING	7674-BN	HOUSING	7674-CN	HOUSING	7674-DN	
TERM. NO	40936-J(561)	TERM. NO	40936-J(561)	TERM. NO	40936-J(561)	TERM. NO	40936-J(561)	
PLATING:	561	PLATING:	561	PLATING:	561	PLATING:	561	
COLOR	BLACK	COLOR	BLACK	COLOR	BLACK	COLOR	BLACK	
MATL NO	ENG NO:	MATL NO	ENG NO:	MATL NO	ENG NO:	MATL NO	ENG NO:	
	A-7674-A02J561A		A-7674-B02J561A		A-7674-C02J561A		A-7674-D02J561A	
	A-7674-A03J561A		A-7674-B03J561A		A-7674-C03J561A		A-7674-D03J561A	
	A-7674-A04J561A		A-7674-B04J561A		A-7674-C04J561A		A-7674-D04J561A	
	A-7674-A05J561A		A-7674-B05J561A		A-7674-C05J561A		A-7674-D05J561A	
	A-7674-A06J561A		A-7674-B06J561A		A-7674-C06J561A		A-7674-D06J561A	
	A-7674-A07J561A		A-7674-B07J561A		A-7674-C07J561A		A-7674-D07J561A	
	A-7674-A08J561A		A-7674-B08J561A		A-7674-C08J561A		A-7674-D08J561A	
	A-7674-A09J561A		A-7674-B09J561A		A-7674-C09J561A		A-7674-D09J561A	
	A-7674-A10J561A		A-7674-B10J561A		A-7674-C10J561A		A-7674-D10J561A	
	A-7674-A11J561A		A-7674-B11J561A		A-7674-C11J561A		A-7674-D11J561A	
	A-7674-A12J561A		A-7674-B12J561A		A-7674-C12J561A		A-7674-D12J561A	
	A-7674-A13J561A		A-7674-B13J561A		A-7674-C13J561A		A-7674-D13J561A	
	A-7674-A14J561A		A-7674-B14J561A		A-7674-C14J561A		A-7674-D14J561A	
	A-7674-A15J561A		A-7674-B15J561A		A-7674-C15J561A		A-7674-D15J561A	
	A-7674-A16J561A		A-7674-B16J561A		A-7674-C16J561A	50-29-1556	A-7674-D16J561A	
REVISION:	<b>AC1</b>	TITLE:				<b>SEE SHEET 1 1/7/2005</b>		SHEET No.
		<b>KK 156 IDT CONNECTOR</b>						<b>11</b>
DOCUMENT NUMBER:		CREATED / REVISED BY:		CHECKED BY:		APPROVED BY:		
<b>SDA-7674-*</b>		<b>J.SCHAFFER 3-10-04</b>		<b>K.SAMIEC 3-15-04</b>		<b>MARGULIS 3-17-04</b>		

A-7674-ANM154A		A-7674-BNM154A		A-7674-CNM154A		A-7674-DNM154A	
HOUSING	7674-AN	HOUSING	7674-BN	HOUSING	7674-CN	HOUSING	7674-DN
TERM. NO	40936-M(154)	TERM. NO	40936-M(154)	TERM. NO	40936-M(154)	TERM. NO	40936-M(154)
PLATING:	154	PLATING:	154	PLATING:	154	PLATING:	154
COLOR	RED	COLOR	RED	COLOR	RED	COLOR	RED
MATL NO	ENG NO:	MATL NO	ENG NO:	MATL NO	ENG NO:	MATL NO	ENG NO:
				50-29-1972	A-7674-C02M154A	50-29-1987	A-7674-D02M154A
				50-29-1973	A-7674-C03M154A	50-29-1988	A-7674-D03M154A
				50-29-1974	A-7674-C04M154A	50-29-1989	A-7674-D04M154A
				50-29-1975	A-7674-C05M154A	50-29-1990	A-7674-D05M154A
				50-29-1976	A-7674-C06M154A	50-29-1991	A-7674-D06M154A
				50-29-1977	A-7674-C07M154A	50-29-1992	A-7674-D07M154A
				50-29-1978	A-7674-C08M154A	50-29-1993	A-7674-D08M154A
				50-29-1979	A-7674-C09M154A	50-29-1994	A-7674-D09M154A
				50-29-1980	A-7674-C10M154A	50-29-1995	A-7674-D10M154A
				50-29-1981	A-7674-C11M154A	50-29-1996	A-7674-D11M154A
				50-29-1982	A-7674-C12M154A	50-29-1997	A-7674-D12M154A
				50-29-1983	A-7674-C13M154A	50-29-1998	A-7674-D13M154A
				50-29-1984	A-7674-C14M154A	50-29-1999	A-7674-D14M154A
				50-29-1985	A-7674-C15M154A	50-29-2000	A-7674-D15M154A
				50-29-1986	A-7674-C16M154A	50-29-2001	A-7674-D16M154A

REVISION: <b>AC1</b>	SEE SHEET 1 1/7/2005	TITLE: <b>KK 156 IDT CONNECTOR</b>	SHEET No. <b>12</b>
-------------------------	-------------------------	---------------------------------------	------------------------

DOCUMENT NUMBER: <b>SDA-7674-*</b>	CREATED / REVISED BY: <b>J.SCHAFFER 3-10-04</b>	CHECKED BY: <b>K.SAMIEC 3-15-04</b>	APPROVED BY: <b>MARGULIS 3-17-04</b>
---------------------------------------	--	--	---