

PLEASE CHECK WWW.MOLEX.COM FOR LATEST PART INFORMATION

Part Number: **0459848113**
Status: **Active**
Overview: extreme_lphpower
Description: 1.27mm (.050"), 12.00mm (.472") Pitch, EXTreme LPHPower™ Receptacle Header, Right Angle, 8 Power Contacts, 12 Signal Contacts, Select Gold (Au) Plating, for 1.57mm (.062") Thick PC Board

Documents:

[3D Model](#) [Product Specification PS-45984-001 \(PDF\)](#)
[Drawing \(PDF\)](#) [RoHS Certificate of Compliance \(PDF\)](#)

Agency Certification

CSA LR19980
 UL E29179

General

Product Family PCB Receptacles
 Series 45984
 Application Board-to-Board
 Overview extreme_lphpower
 Product Name EXTreme LPHPower™

Physical

Circuits (Loaded) 20
 Circuits (maximum) 20
 Circuits Detail 8 Power, 12 Signal
 Color - Resin Black
 Durability (mating cycles max) 250
 Flammability 94V-0
 Glow-Wire Compliant No
 Guide to Mating Part No
 Keying to Mating Part Yes
 Lock to Mating Part No
 Material - Metal High Performance Alloy (HPA), Phosphor Bronze
 Material - Plating Mating Gold
 Material - Plating Termination Tin
 Material - Resin High Temperature Thermoplastic
 Number of Rows 2
 Orientation Right Angle
 PC Tail Length (in) 0.114 In
 PC Tail Length (mm) 2.90 mm
 PCB Locator No
 PCB Retention None
 PCB Thickness Recommended (in) 0.062 In
 PCB Thickness Recommended (mm) 1.57 mm
 Packaging Type Tray
 Pitch - Mating Interface (in) 0.050 In, 0.472 In
 Pitch - Mating Interface (mm) 1.27 mm, 12.00 mm
 Plating min: Mating (µin) 30
 Plating min: Mating (µm) 0.75
 Plating min: Termination (µin) 150, 75
 Plating min: Termination (µm) 1.875, 3.75
 Polarized to Mating Part Yes
 Polarized to PCB Yes
 Stackable No
 Surface Mount Compatible (SMC) Yes

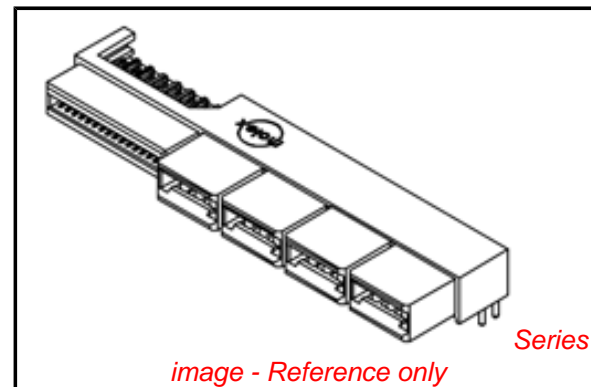

image - Reference only

EU RoHS

**ELV and RoHS
 Compliant**

REACH SVHC

Contains SVHC: No

Halogen-Free

Status

Halogen-Free

China RoHS



**Need more information on product
 environmental compliance?**

Email productcompliance@molex.com
 For a multiple part number RoHS Certificate of Compliance, [click here](#)

Please visit the [Contact Us](#) section for any non-product compliance questions.

Search Parts in this Series

[45984Series](#)

Mates With

[45985](#) EXTreme LPHPower™ Headers, 1.57mm (.062") Card Edge

Temperature Range - Operating -40°C to +105°C
Termination Interface: Style Through Hole

Electrical

Current - Maximum per Contact 23A
Grounding to PCB No
Voltage - Maximum 250V AC (RMS)/DC

Solder Process Data

Duration at Max. Process Temperature (seconds) 20
Lead-free Process Capability Wave Capable (TH only)
Max. Cycles at Max. Process Temperature 3
Process Temperature max. C 260

Material Info

Reference - Drawing Numbers

Packaging Specification PK-45984-001
Product Specification PS-45984-001
Sales Drawing SD-45984-800

This document was generated on 05/21/2010

PLEASE CHECK WWW.MOLEX.COM FOR LATEST PART INFORMATION



- NOTES:
1. MATERIAL HOUSING: LCP, 94V-0, COLOR-BLACK.
CONTACT: COPPER ALLOY.
 2. FINISH: SELECT GOLD - .762 μM/30 MI MIN. CONTACT AREA.
SELECT TIN - 3.81 μM/150 MI MIN. TAIL AREA.
BOTH OVER NICKEL - 1.27 μM/50 MI MIN.
 3. POWER TERMINALS LUBRICATED IN CONTACT AREA.
 4. PRODUCT SPECIFICATION: PS-45984-001.
 5. PACKAGING: TRAY PER PK-45984-001.
 6. SEE SHEET 5 FOR CKT IDENTIFICATION.
 7. PARTS ARE RoHS COMPLIANT.
 8. PEG HOLES ARE OPTIONAL SEE SHEET 3 AND 4.
 9. MATES TO 1.57/062 CARD EDGE OR MOLEX P/N 45985-8***.

NO OF SIGNAL	MATERIAL NUMBER	DIM A	DIM P	PCB THK
12	45984-8111	59.5	4.50	3.18
16	45984-8121	62.0		
20	45984-8131	64.6		
24	45984-8141	67.1		
28	45984-8151	69.6	3.60	2.36
32	45984-8161	72.2		
36	45984-8171	74.7		
40	45984-8181	77.3		
12	45984-8112	59.5	2.90	1.57
16	45984-8122	62.0		
20	45984-8132	64.6		
24	45984-8142	67.1		
28	45984-8152	69.6	2.90	1.57
32	45984-8162	72.2		
36	45984-8172	74.7		
40	45984-8182	77.3		
12	45984-8113	59.5	2.90	1.57
16	45984-8123	62.0		
20	45984-8133	64.6		
24	45984-8143	67.1		
28	45984-8153	69.6	2.90	1.57
32	45984-8163	72.2		
36	45984-8173	74.7		
40	45984-8183	77.3		

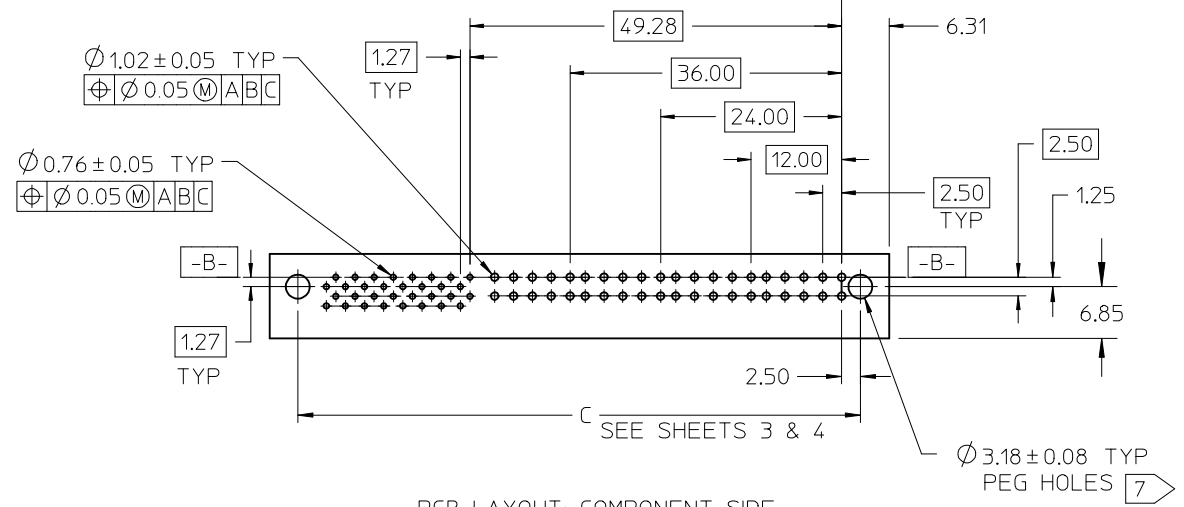

PCB LAYOUT: COMPONENT SIDE
PEG HOLES OPTIONAL



45984-8161 SHOWN
FOR REF ONLY
SEE CHART

REVISED	DESCRIPTION
EC NO: UCP2009-0971	2008/11/13
DRWN:MBANDURA	2008/11/14
CHKD:	
APPR:APATEL	2008/11/17
REV	

GENERAL TOLERANCES (UNLESS SPECIFIED)	
	mm
4 PLACES	± ---
3 PLACES	± ---
2 PLACES	± 0.25
1 PLACE	± ---
ANGULAR ± 1/2°	
DRAFT WHERE APPLICABLE MUST REMAIN WITHIN DIMENSIONS	

DIMENSION STYLE	
MM ONLY	
DRAWN BY	DATE
SAMIEC	2005/05/13
CHECKED BY	DATE
SAMIEC	2005/05/13
APPROVED BY	DATE
MARGULIS	2005/05/13
MATERIAL NO.	SEE CHART
SIZE	A

SCALE	DESIGN UNITS	THIRD ANGLE PROJECTION
1:1	METRIC	
TITLE		
LPH RECEPTACLE ASSEMBLY RT ANGLE 8 CIRCUIT POWER CONNECTOR		
molex MOLEX INCORPORATED		
DOCUMENT NO.	SHEET NO.	
SD-45984-800	1 OF 5	
THIS DRAWING CONTAINS INFORMATION THAT IS PROPRIETARY TO MOLEX INCORPORATED AND SHOULD NOT BE USED WITHOUT WRITTEN PERMISSION		

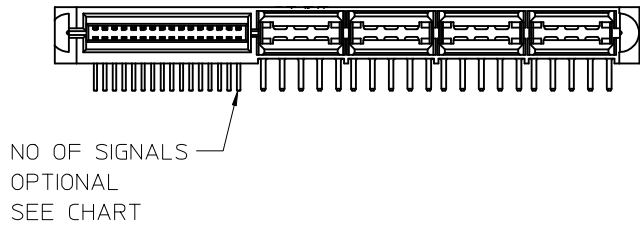
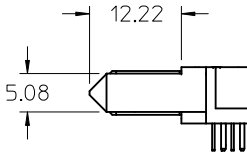
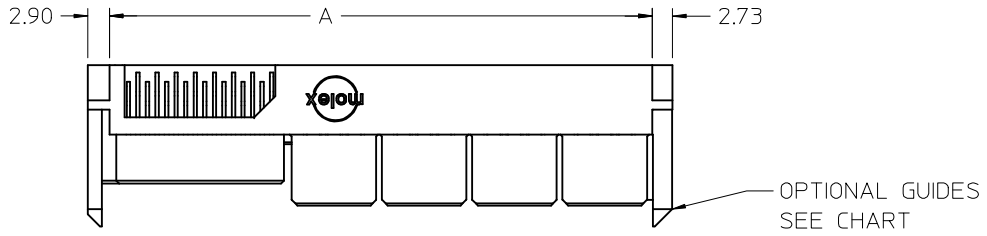

GUIDE POST OPTIONS

NO OF SIGNAL	MATERIAL NUMBER	DIM A	DIM P	PCB THK
12	45984-8211	59.5	4.50	3.18
16	45984-8221	62.0		
20	45984-8231	64.6		
24	45984-8241	67.1		
28	45984-8251	69.6		
32	45984-8261	72.2	3.60	2.36
36	45984-8271	74.7		
40	45984-8281	77.3		
12	45984-8212	59.5		
16	45984-8222	62.0		
20	45984-8232	64.6	2.90	1.57
24	45984-8242	67.1		
28	45984-8252	69.6		
32	45984-8262	72.2		
36	45984-8272	74.7		
40	45984-8282	77.3	2.90	1.57
12	45984-8213	59.5		
16	45984-8223	62.0		
20	45984-8233	64.6		
24	45984-8243	67.1	2.90	1.57
28	45984-8253	69.6		
32	45984-8263	72.2		
36	45984-8273	74.7		
40	45984-8283	77.3		

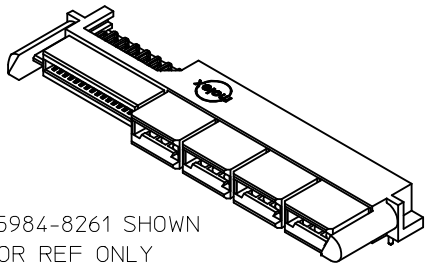

45984-8261 SHOWN FOR REF ONLY SEE CHART

REVISED	DESCRIPTION
EC NO: UCP2009-0971	
DRWN:MBANDURA 2008/11/13	
CHKD: 2008/11/14	
APPR:APATEL 2008/11/17	
REV	

GENERAL TOLERANCES (UNLESS SPECIFIED)	
	mm INCH
4 PLACES	± --- ± ---
3 PLACES	± --- ± ---
2 PLACES	± 0.25 ± ---
1 PLACE	± --- ± ---
ANGULAR ±1/2°	
DRAFT WHERE APPLICABLE MUST REMAIN WITHIN DIMENSIONS	

DIMENSION STYLE	
MM ONLY	
DRAWN BY	DATE
SAMIEC	2005/05/13
CHECKED BY	DATE
SAMIEC	2005/05/13
APPROVED BY	DATE
MARGULIS	2005/05/13
MATERIAL NO.	
SEE CHART	
SIZE	
A	

SCALE	DESIGN UNITS	THIRD ANGLE PROJECTION	
1:1	METRIC		
TITLE			
LPH RECEPTACLE ASSEMBLY RT ANGLE 8 CIRCUIT POWER CONNECTOR			
MOLEX INCORPORATED			
DOCUMENT NO.		SHEET NO.	
SD-45984-800		2 OF 5	
THIS DRAWING CONTAINS INFORMATION THAT IS PROPRIETARY TO MOLEX INCORPORATED AND SHOULD NOT BE USED WITHOUT WRITTEN PERMISSION			

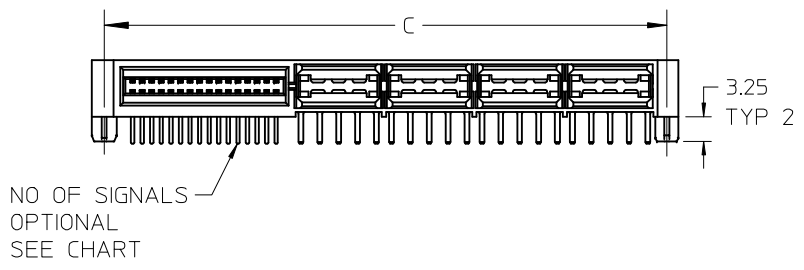

MOUNTING PEG OPTIONS

NO OF SIGNAL	MATERIAL NUMBER	DIM A	DIM C	DIM P	PCB THK
12	45984-8311	59.5	61.90	4.50	3.18
16	45984-8321	62.0	64.44		
20	45984-8331	64.6	66.98		
24	45984-8341	67.1	69.52		
28	45984-8351	69.6	72.06		
32	45984-8361	72.2	74.60		
36	45984-8371	74.7	77.14	3.60	2.36
40	45984-8381	77.3	79.68		
12	45984-8312	59.5	61.90		
16	45984-8322	62.0	64.44		
20	45984-8332	64.6	66.98		
24	45984-8342	67.1	69.52		
28	45984-8352	69.6	72.06	2.90	1.57
32	45984-8362	72.2	74.60		
36	45984-8372	74.7	77.14		
40	45984-8382	77.3	79.68		
12	45984-8313	59.5	61.90		
16	45984-8323	62.0	64.44		
20	45984-8333	64.6	66.98		
24	45984-8343	67.1	69.52		
28	45984-8353	69.6	72.06		
32	45984-8363	72.2	74.60		
36	45984-8373	74.7	77.14		
40	45984-8383	77.3	79.68		



45984-8361 SHOWN
FOR REF ONLY
SEE CHART

REVISED EC NO: UCP2009-0971 DRWN:MBANDURA 2008/11/13 CHKD: 2008/11/14 APPR:APATEL 2008/11/17 DESCRIPTION REV	GENERAL TOLERANCES (UNLESS SPECIFIED)		DIMENSION STYLE MM ONLY		SCALE 1:1	DESIGN UNITS METRIC	THIRD ANGLE PROJECTION		
		mm	INCH	DRAWN BY SAMIEC	DATE 2005/05/13	TITLE LPH RECEPTACLE ASSEMBLY RT ANGLE 8 CIRCUIT POWER CONNECTOR			
	4 PLACES	± ---	± ---	CHECKED BY SAMIEC	DATE 2005/05/13				
	3 PLACES	± ---	± ---	APPROVED BY MARGULIS	DATE 2005/05/13	MOLEX INCORPORATED DOCUMENT NO. SD-45984-800			
2 PLACES	± 0.25	± ---	MATERIAL NO. SEE CHART		SHEET NO. 3 OF 5				
1 PLACE	± ---	± ---	ANGULAR ±1/2°		THIS DRAWING CONTAINS INFORMATION THAT IS PROPRIETARY TO MOLEX INCORPORATED AND SHOULD NOT BE USED WITHOUT WRITTEN PERMISSION				
DRAFT WHERE APPLICABLE MUST REMAIN WITHIN DIMENSIONS									

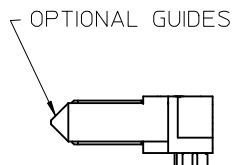
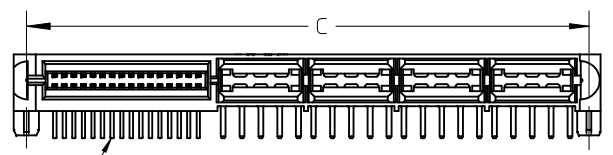

NO OF SIGNALS
OPTIONAL
SEE CHART

GUIDE POST & MOUNTING PEG OPTIONS

NO OF SIGNAL	MATERIAL NUMBER	DIM A	DIM C	DIM P	PCB THK
12	45984-8411	59.5	61.90	4.50	3.18
16	45984-8421	62.0	64.44		
20	45984-8431	64.6	66.98		
24	45984-8441	67.1	69.52		
28	45984-8451	69.6	72.06		
32	45984-8461	72.2	74.60		
36	45984-8471	74.7	77.14	3.60	2.36
40	45984-8481	77.3	79.68		
12	45984-8412	59.5	61.90		
16	45984-8422	62.0	64.44		
20	45984-8432	64.6	66.98		
24	45984-8442	67.1	69.52		
28	45984-8452	69.6	72.06	2.90	1.57
32	45984-8462	72.2	74.60		
36	45984-8472	74.7	77.14		
40	45984-8482	77.3	79.68		
12	45984-8413	59.5	61.90		
16	45984-8423	62.0	64.44		
20	45984-8433	64.6	66.98	2.90	1.57
24	45984-8443	67.1	69.52		
28	45984-8453	69.6	72.06		
32	45984-8463	72.2	74.60		
36	45984-8473	74.7	77.14		
40	45984-8483	77.3	79.68		

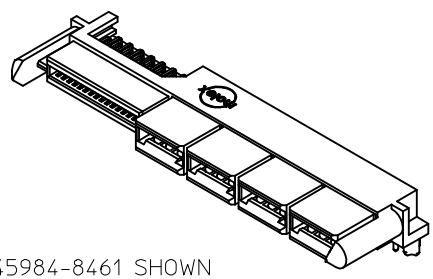

45984-8461 SHOWN
FOR REF ONLY
SEE CHART

REVISED	EC NO: UCP2009-0971	2008/11/13	2008/11/14	2008/11/17
DRWN:MBANDURA	CHKD:	APPR:APATEL	DESCRIPTION	
REV				

GENERAL TOLERANCES (UNLESS SPECIFIED)		
	mm	INCH
4 PLACES	± ---	± ---
3 PLACES	± ---	± ---
2 PLACES	± 0.25	± ---
1 PLACE	± ---	± ---
ANGULAR ±1/2°		
DRAFT WHERE APPLICABLE MUST REMAIN WITHIN DIMENSIONS		

DIMENSION STYLE	
MM ONLY	
DRAWN BY	DATE
SAMIEC	2005/05/13
CHECKED BY	DATE
SAMIEC	2005/05/13
APPROVED BY	DATE
MARGULIS	2005/05/13
MATERIAL NO.	
SEE CHART	

SCALE	DESIGN UNITS	THIRD ANGLE PROJECTION	
1:1	METRIC		
TITLE			
LPH RECEPTACLE ASSEMBLY RT ANGLE 8 CIRCUIT POWER CONNECTOR			
MOLEX INCORPORATED			
DOCUMENT NO.			SHEET NO.
SD-45984-800			4 OF 5
THIS DRAWING CONTAINS INFORMATION THAT IS PROPRIETARY TO MOLEX INCORPORATED AND SHOULD NOT BE USED WITHOUT WRITTEN PERMISSION			

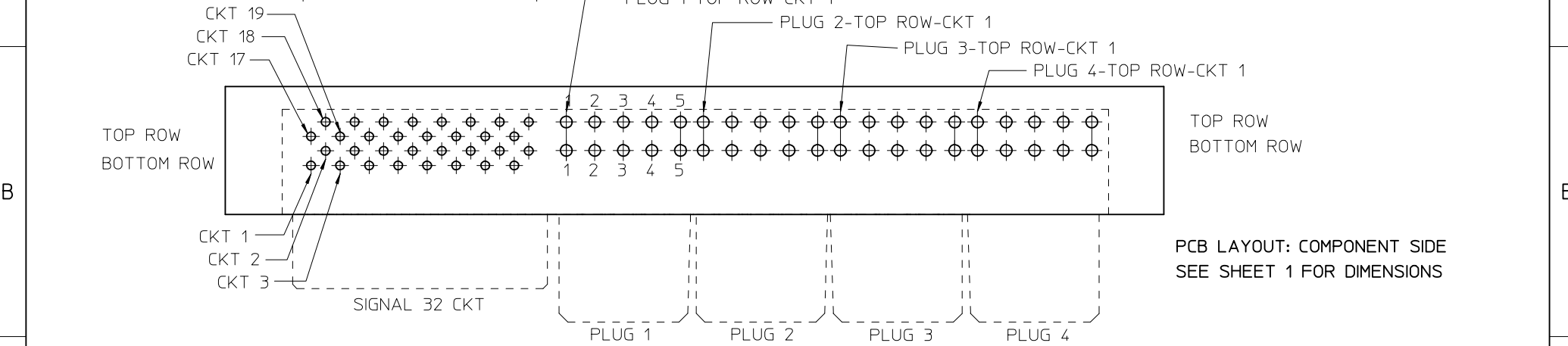
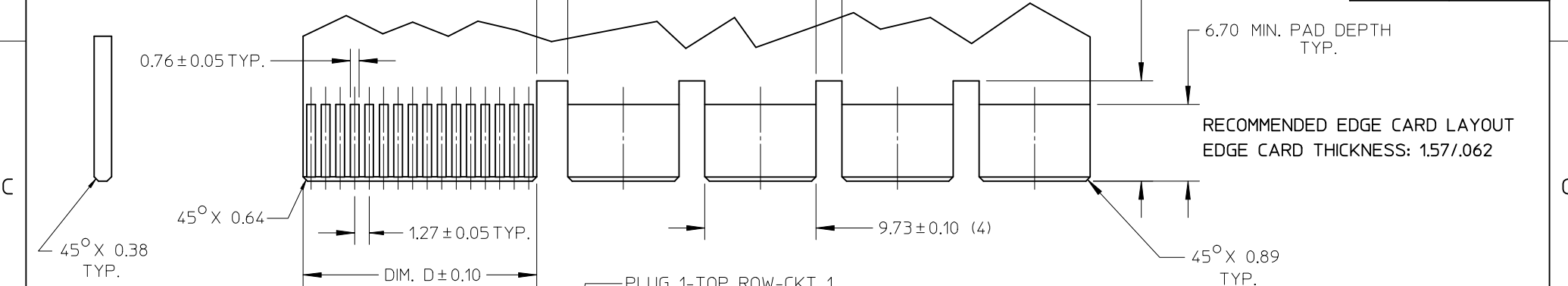

REVISED EC NO: UCP2009-0971 DRWN: MBANDURA 2008/11/13 CHKD: 2008/11/14 APPR: APATEL 2008/11/17 DESCRIPTION REV	GENERAL TOLERANCES (UNLESS SPECIFIED)		DIMENSION STYLE MM ONLY		SCALE 2:1	DESIGN UNITS METRIC	THIRD ANGLE PROJECTION
		mm	INCH	DRAWN BY SAMIEC	DATE 2005/05/13	LPH RECEPTACLE ASSEMBLY RT ANGLE 8 CIRCUIT POWER CONNECTOR	
	4 PLACES	± ---	± ---	CHECKED BY SAMIEC	DATE 2005/05/13		
	3 PLACES	± ---	± ---	APPROVED BY MARGULIS	DATE 2005/05/13	MOLEX INCORPORATED DOCUMENT NO. SD-45984-800	
2 PLACES	± 0.25	± ---	MATERIAL NO.		SHEET NO. 5 OF 5		
1 PLACE	± ---	± ---	DRAFT WHERE APPLICABLE MUST REMAIN WITHIN DIMENSIONS		THIS DRAWING CONTAINS INFORMATION THAT IS PROPRIETARY TO MOLEX INCORPORATED AND SHOULD NOT BE USED WITHOUT WRITTEN PERMISSION		
ANGULAR ± 1/2°							