



36 V Precision, 2.8 nV/ $\sqrt{\text{Hz}}$ Rail-to-Rail Output Op Amp

AD8675

FEATURES

- Very low voltage noise 2.8 nV/ $\sqrt{\text{Hz}}$
- Rail-to-rail output swing
- Low input bias current: 2 nA maximum
- Very low offset voltage: 75 μV maximum
- Low input offset drift: 0.6 $\mu\text{V}/^\circ\text{C}$ maximum
- Very high gain: 120 dB
- Wide bandwidth: 10 MHz typical
- $\pm 5\text{ V}$ to $\pm 18\text{ V}$ operation

APPLICATIONS

- Precision instrumentation
- PLL filters
- Laser diode control loops
- Strain gage amplifiers
- Medical instrumentation
- Thermocouple amplifiers

GENERAL DESCRIPTION

The AD8675 precision operational amplifier has ultralow offset, drift, and voltage noise combined with very low input bias currents over the full operating temperature range. The AD8675 is a precision, wide bandwidth op amp featuring rail-to-rail output swings and very low noise. Operation is fully specified from $\pm 5\text{ V}$ to $\pm 15\text{ V}$.

The AD8675 features a rail-to-rail output like that of the [OP184](#), but with wide bandwidth and even lower voltage noise, combined with the precision and low power consumption like that of the industry-standard OP07 amplifier. Unlike other low noise, rail-to-rail op amps, the AD8675 has very low input bias current and low input current noise.

With typical offset voltage of only 10 μV , offset drift of 0.2 $\mu\text{V}/^\circ\text{C}$, and noise of only 0.10 μV p-p (0.1 Hz to 10 Hz), the AD8675 is perfectly suited for applications where large error sources cannot be tolerated. For applications with even lower offset tolerances, the proprietary nulling capability allows a combination of both device and system offset errors up to 3.5 mV (referred to the input) to be compensated externally. Unlike previous

PIN CONFIGURATIONS

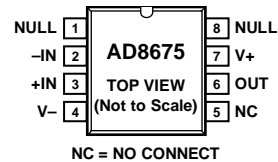

Figure 1. 8-Lead SOIC_N (R-8)

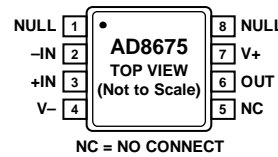

Figure 2. 8-Lead MSOP (RM-8)

circuits, the AD8675 accommodates this adjustment without adversely affecting the offset drift, CMRR, and PSRR of the amplifier. Precision instrumentation, PLL, and other precision filter circuits, position and pressure sensors, medical instrumentation, and strain gage amplifiers benefit greatly from the very low noise, low input bias current, and wide bandwidth. Many systems can take advantage of the low noise, dc precision, and rail-to-rail output swing provided by the AD8675 to maximize SNR and dynamic range.

The smaller packages and low power consumption afforded by the AD8675 allow maximum channel density or minimum board size for space-critical equipment.

The AD8675 is specified for the extended industrial temperature range (-40°C to $+125^\circ\text{C}$). The AD8675 amplifier is available in the tiny MSOP-8, and the popular 8-lead, narrow SOIC, lead-free packages. MSOP packaged devices are only available in tape and reel format.

Rev. 0

Information furnished by Analog Devices is believed to be accurate and reliable. However, no responsibility is assumed by Analog Devices for its use, nor for any infringements of patents or other rights of third parties that may result from its use. Specifications subject to change without notice. No license is granted by implication or otherwise under any patent or patent rights of Analog Devices. Trademarks and registered trademarks are the property of their respective owners.

One Technology Way, P.O. Box 9106, Norwood, MA 02062-9106, U.S.A.
Tel: 781.329.4700 www.analog.com
Fax: 781.461.3113 © 2005 Analog Devices, Inc. All rights reserved.

AD8675

TABLE OF CONTENTS

Features	1	Absolute Maximum Ratings	5
Applications.....	1	Thermal Resistance	5
Pin Configurations	1	ESD Caution.....	5
General Description	1	Typical Performance Characteristics	6
Revision History	2	Outline Dimensions	11
Specifications.....	3	Ordering Guide	11
Electrical Specifications.....	3		

REVISION HISTORY

10/05—Revision 0: Initial Version

SPECIFICATIONS

ELECTRICAL SPECIFICATIONS

$V_S = \pm 5.0\text{ V}$, $V_{CM} = 0\text{ V}$, $V_O = 0\text{ V}$, $T_A = +25^\circ\text{C}$, unless otherwise specified.

Table 1.

Parameter	Symbol	Conditions	Min	Typ	Max	Unit
INPUT CHARACTERISTICS						
Offset Voltage	V_{OS}	$-40^\circ\text{C} \leq T_A \leq +125^\circ\text{C}$		10 12	75 240	μV
Input Bias Current	I_B	$-40^\circ\text{C} \leq T_A \leq +125^\circ\text{C}$	-2 -5.5	0.5 -2	2 5.5	nA
Input Offset Current	I_{OS}	$-40^\circ\text{C} \leq T_A \leq +125^\circ\text{C}$	-1 -2.8	0.1 0.1	1 2.8	nA
Input Voltage Range			-3.5		3.5	V
Common-Mode Rejection Ratio	CMRR	$V_{CM} = -3.5\text{ V to }+3.5\text{ V}$ $-40^\circ\text{C} \leq T_A \leq +125^\circ\text{C}$	105	130		dB
Open Loop Gain	A_{VO}	$R_L = 2\text{ k}\Omega$ to ground, $V_O = -4.0\text{ V to }+4.0\text{ V}$ $-40^\circ\text{C} \leq T_A \leq +125^\circ\text{C}$	1000	2000		V/mV
Offset Voltage Drift	$\Delta V_{OS}/\Delta T$	$-40^\circ\text{C} \leq T_A \leq +125^\circ\text{C}$		700 1250 0.2		V/mV $\mu\text{V}/^\circ\text{C}$
OUTPUT CHARACTERISTICS						
Output Voltage High	V_{OH}	$R_L = 2\text{ k}\Omega$ to ground $-40^\circ\text{C} \leq T_A \leq +125^\circ\text{C}$	4.86 4.82	4.90 4.85		V V
Output Voltage Low	V_{OL}	$R_L = 2\text{ k}\Omega$ to ground $-40^\circ\text{C} \leq T_A \leq +125^\circ\text{C}$		-4.91 -4.91	-4.86 -4.82	V V
Short-Circuit Limit	I_{SC}			40		mA
Output Current	I_O			± 20		mA
POWER SUPPLY						
Power Supply Rejection Ratio	PSRR	$V_S = \pm 5.0\text{ V to } \pm 15.0\text{ V}$ $-40^\circ\text{C} \leq T_A \leq +125^\circ\text{C}$	120 120	140 140		dB dB
Supply Current/Amplifier	I_{SY}	$V_O = 0\text{ V}$ $-40^\circ\text{C} \leq T_A \leq +125^\circ\text{C}$		2.3 2.7	2.7 3.4	mA mA
DYNAMIC PERFORMANCE						
Slew Rate	SR	$R_L = 2\text{ k}\Omega$		2.5		V/ μs
Gain Bandwidth Product	GBP			10		MHz
NOISE PERFORMANCE						
Voltage Noise	$e_{n,p-p}$	0.1 Hz to 10 Hz		0.1		$\mu\text{V p-p}$
Voltage Noise Density	e_n	$f = 1\text{ kHz}$		2.8		nV/ $\sqrt{\text{Hz}}$
Current Noise Density	i_n	$f = 10\text{ Hz}$		0.3		pA/ $\sqrt{\text{Hz}}$

AD8675

$V_S = \pm 15\text{ V}$, $V_{CM} = 0\text{ V}$, $V_O = 0\text{ V}$, $T_A = +25^\circ\text{C}$, unless otherwise specified.

Table 2.

Parameter	Symbol	Conditions	Min	Typ	Max	Units
INPUT CHARACTERISTICS						
Offset Voltage	V_{OS}	$-40^\circ\text{C} \leq T_A \leq +125^\circ\text{C}$		10 12	75 240	μV
Input Bias Current	I_B	$-40^\circ\text{C} \leq T_A \leq +125^\circ\text{C}$	-2 -4.5	0.5 1	2 4.5	nA
Input Offset Current	I_{OS}	$-40^\circ\text{C} \leq T_A \leq +125^\circ\text{C}$	-1 -2.8	0.1 0.1	1 2.8	nA
Input Voltage Range			-13.5		13.5	V
Common-Mode Rejection Ratio	CMRR	$V_{CM} = -12.5\text{ V to } 12.5\text{ V}$ $-40^\circ\text{C} \leq T_A \leq +125^\circ\text{C}$	114	130		dB
Open Loop Gain	A_{VO}	$R_L = 2\text{ k}\Omega$ to ground, $V_O = -14.0\text{ V to } 14.0\text{ V}$ $-40^\circ\text{C} \leq T_A \leq +125^\circ\text{C}$	1500	4000		V/mV
Offset Voltage Drift	$\Delta V_{OS}/\Delta T$	$-40^\circ\text{C} \leq T_A \leq +125^\circ\text{C}$	700	1700	0.6	V/mV $\mu\text{V}/^\circ\text{C}$
OUTPUT CHARACTERISTICS						
Output Voltage High	V_{OH}	SOIC $R_L = 2\text{ k}\Omega$ to ground MSOP SOIC $-40^\circ\text{C} \leq T_A \leq +125^\circ\text{C}$ MSOP $-40^\circ\text{C} \leq T_A \leq +125^\circ\text{C}$	14.75 14.67 14.69	14.8 14.78 14.75		V V V
Output Voltage Low	V_{OL}	$R_L = 2\text{ k}\Omega$ to ground $-40^\circ\text{C} \leq T_A \leq +125^\circ\text{C}$	14.3	14.66 -14.85 -14.78	-14.75 -14.69	V V V
Short-Circuit Limit	I_{SC}			40		V mA
Output Current	I_O			± 20		mA mA mA
POWER SUPPLY						
Power Supply Rejection Ratio	PSRR	$V_S = \pm 5.0\text{ V to } \pm 15.0\text{ V}$ $-40^\circ\text{C} \leq T_A \leq +125^\circ\text{C}$	120	140		dB
Supply Current/Amplifier	I_{SY}	$V_O = 0\text{ V}$ $-40^\circ\text{C} \leq T_A \leq +125^\circ\text{C}$	120	140	2.5 2.9	dB mA mA
DYNAMIC PERFORMANCE						
Slew Rate	SR	$R_L = 10\text{ k}\Omega$		2.5		V/ μs
Gain Bandwidth Product	GBP			10		MHz
NOISE PERFORMANCE						
Voltage Noise	$e_{n\text{ p-p}}$	0.1 Hz to 10 Hz		0.1		$\mu\text{Vp-p}$
Voltage Noise Density	e_n	$f = 1\text{ kHz}$		2.8		nV/ $\sqrt{\text{Hz}}$
Current Noise Density	i_n	$f = 10\text{ Hz}$		0.3		pA/ $\sqrt{\text{Hz}}$

ABSOLUTE MAXIMUM RATINGS

Table 3.

Parameter	Rating
Supply Voltage	± 18 V
Input Voltage	$\pm V$ supply
Differential Input Voltage	± 0.7 V
Output Short-Circuit Duration to GND	Indefinite
Storage Temperature Range	
RM, R Packages	-65°C to $+150^{\circ}\text{C}$
Operating Temperature Range	-40°C to $+125^{\circ}\text{C}$
Junction Temperature Range	
RM, R Packages	-65°C to $+150^{\circ}\text{C}$
Lead Temperature Range (Soldering, 10 sec)	$+300^{\circ}\text{C}$

Stresses above those listed under Absolute Maximum Ratings may cause permanent damage to the device. This is a stress rating only; functional operation of the device at these or any other conditions above those indicated in the operational section of this specification is not implied. Exposure to absolute maximum rating conditions for extended periods may affect device reliability.

THERMAL RESISTANCE

Table 4. Thermal Resistance

Package Type	θ_{JA}	θ_{JC}	Unit
8-Lead MSOP (RM)	210	45	$^{\circ}\text{C}/\text{W}$
8-Lead SOIC_N (R)	158	43	$^{\circ}\text{C}/\text{W}$

ESD CAUTION

ESD (electrostatic discharge) sensitive device. Electrostatic charges as high as 4000 V readily accumulate on the human body and test equipment and can discharge without detection. Although this product features proprietary ESD protection circuitry, permanent damage may occur on devices subjected to high energy electrostatic discharges. Therefore, proper ESD precautions are recommended to avoid performance degradation or loss of functionality.



AD8675

TYPICAL PERFORMANCE CHARACTERISTICS

$\pm 15\text{ V}$ and $\pm 5\text{ V}$, $T_A = 25^\circ\text{C}$, unless otherwise specified.

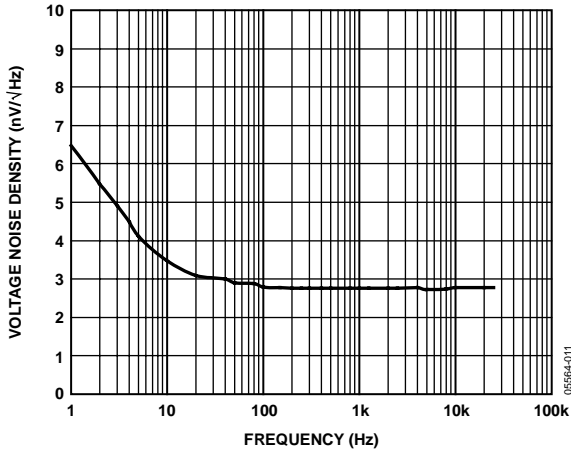

Figure 3. Voltage Noise Density vs. Frequency

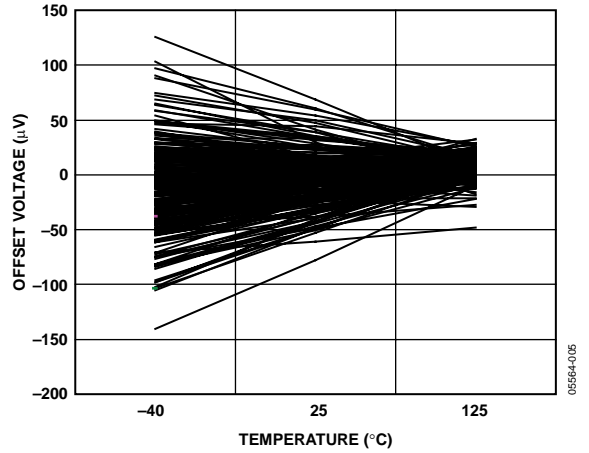

Figure 6. Offset Voltage vs. Temperature

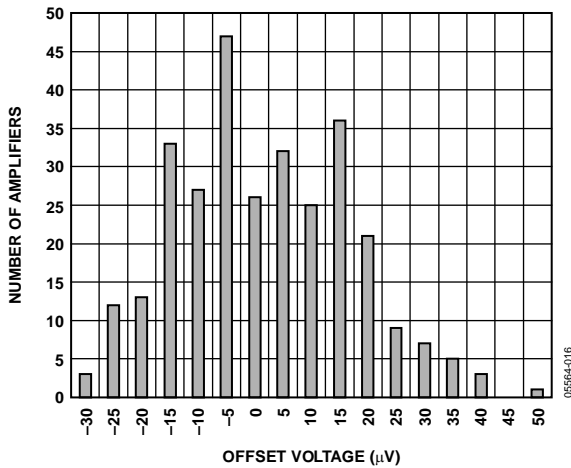

Figure 4. Input Offset Voltage Distribution

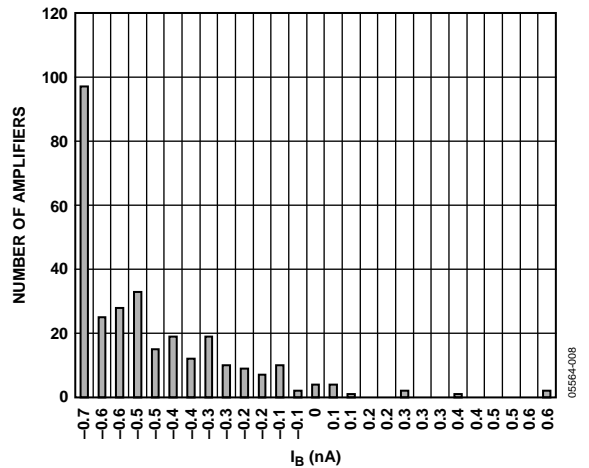

Figure 7. Input Bias Current, $V_{SV} = \pm 15\text{ V}$

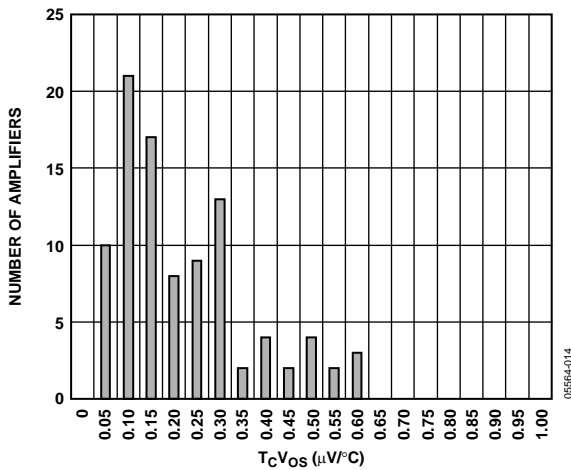

Figure 5. T_cV_{os}

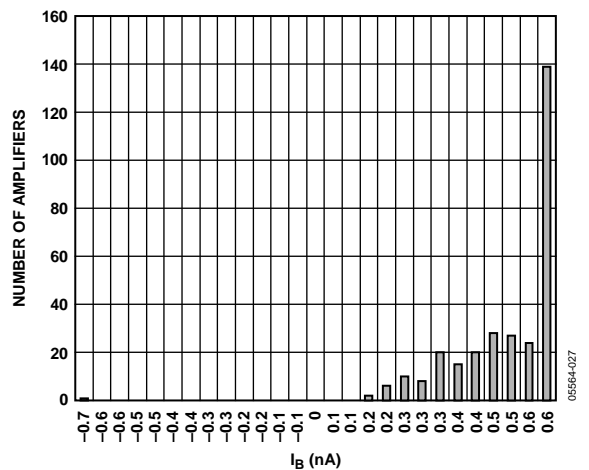

Figure 8. Input Bias Current, $V_{SV} = \pm 5\text{ V}$

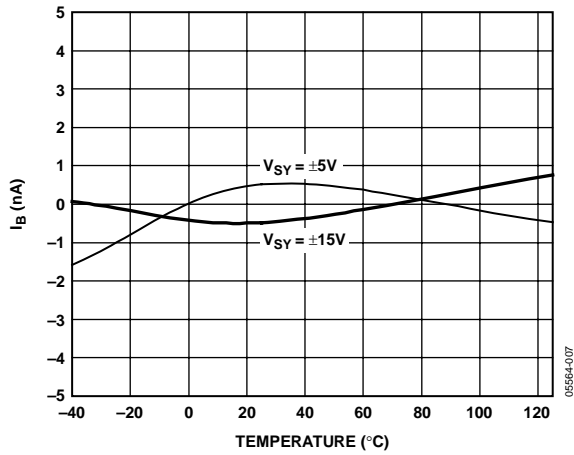

Figure 9. Input Bias Current vs. Temperature

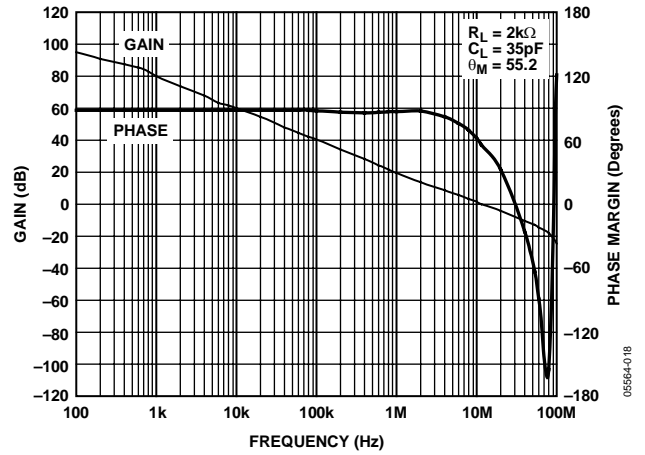

Figure 12. Gain and Phase vs. Frequency

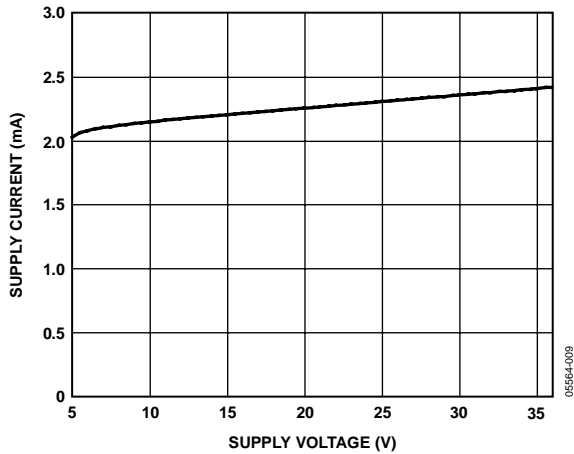

Figure 10. Supply Current vs. Total Supply Voltage

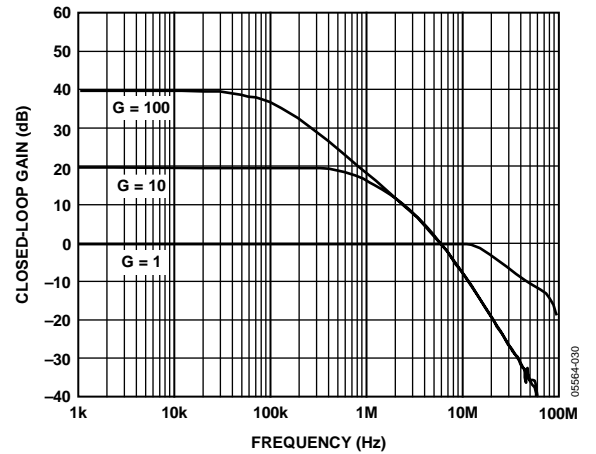

Figure 13. Closed-Loop Gain vs. Frequency

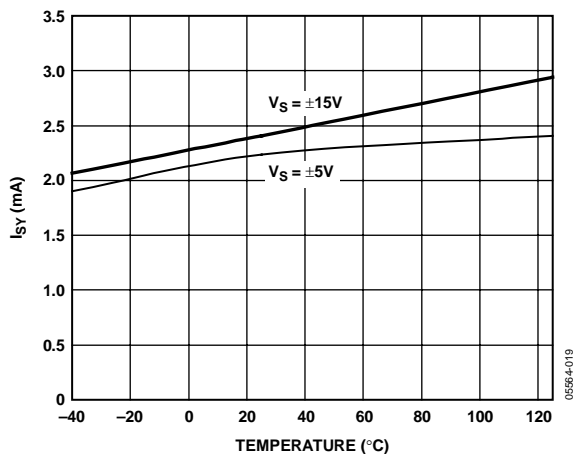

Figure 11. Supply Current vs. Temperature

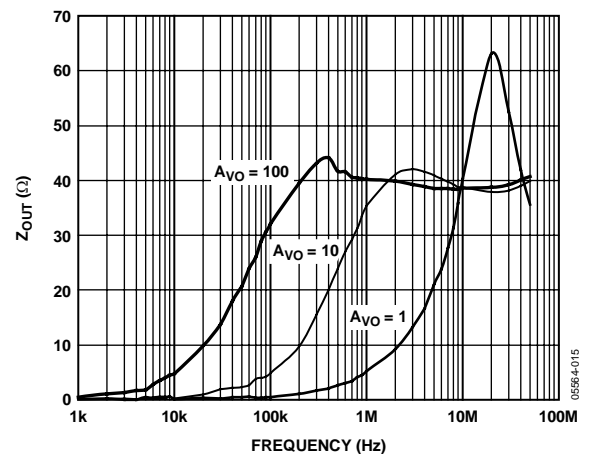

Figure 14. Z_{OUT} vs. Frequency

AD8675

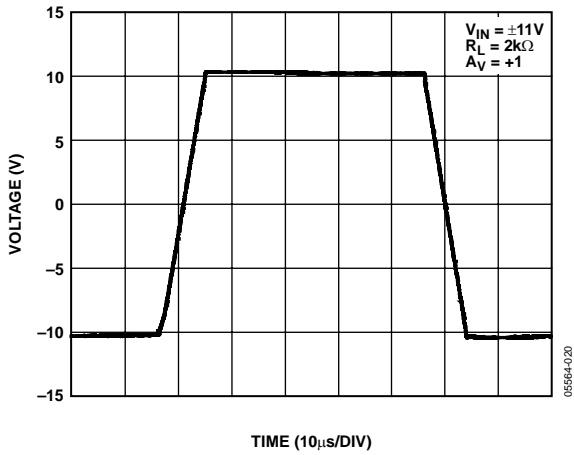

Figure 15. Large Signal Transient Response, $V_{SY} = \pm 15\text{ V}$

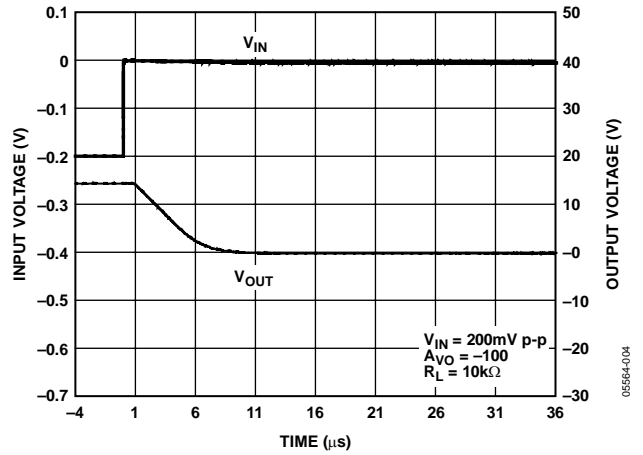

Figure 18. Positive Overvoltage Recovery

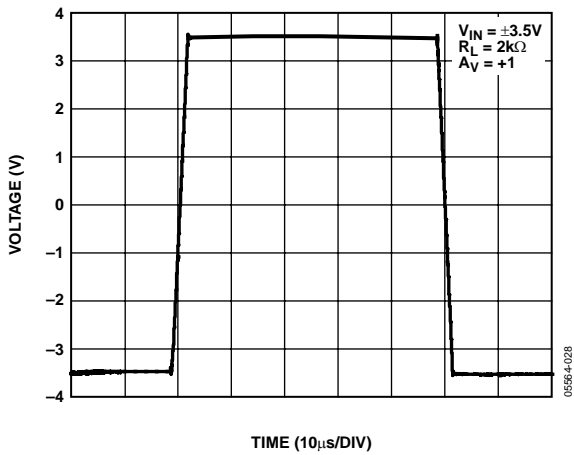

Figure 16. Large Signal Transient Response, $V_{SY} = \pm 5\text{ V}$

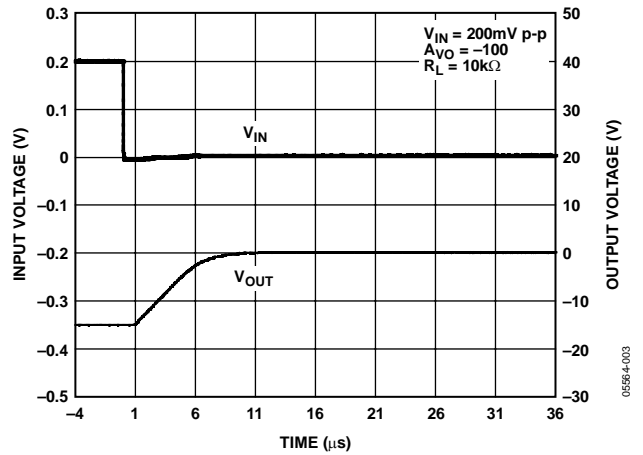

Figure 19. Negative Overvoltage Recovery

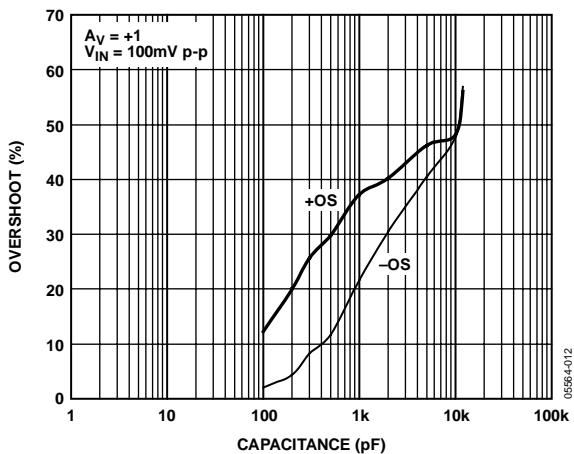

Figure 17. Small Signal Overshoot vs. Load Capacitance

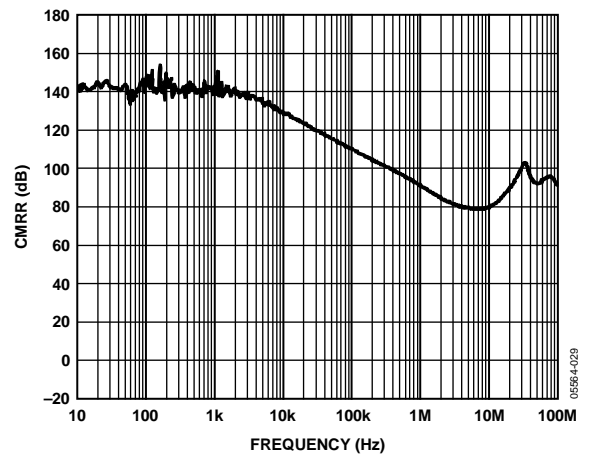

Figure 20. CMRR vs. Frequency

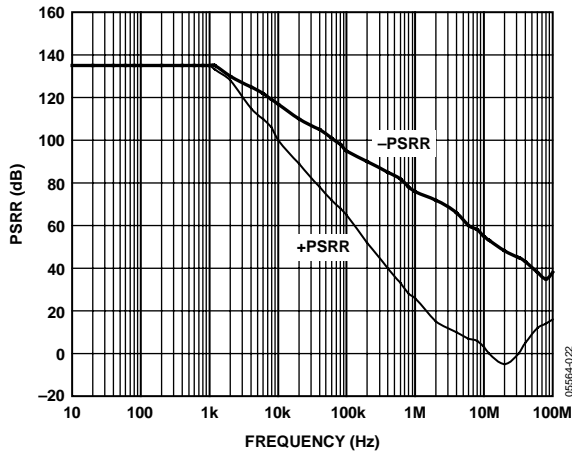

Figure 21. PSRR vs. Frequency

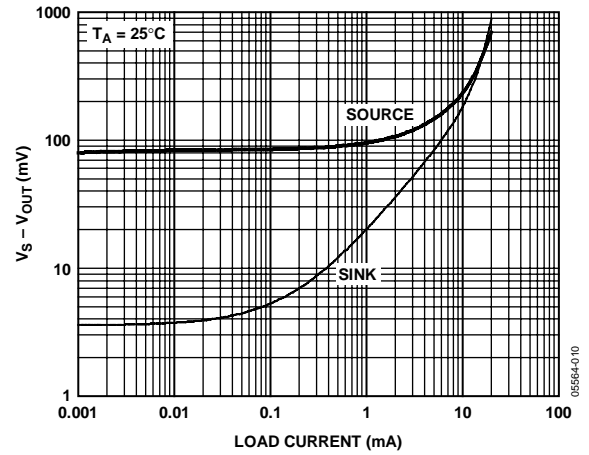

Figure 24. Output Saturation Voltage vs. Output Current

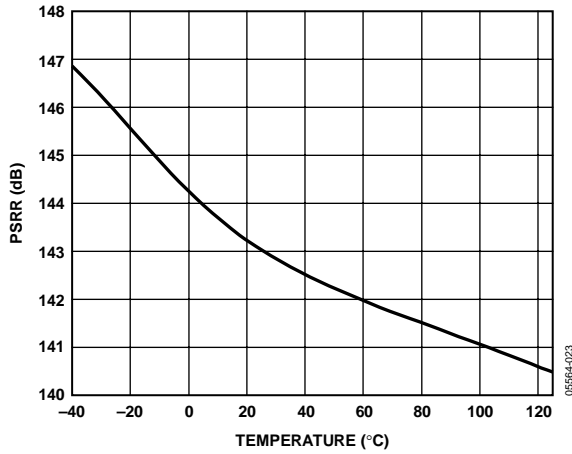

Figure 22. Power Supply Rejection Ratio vs. Temperature

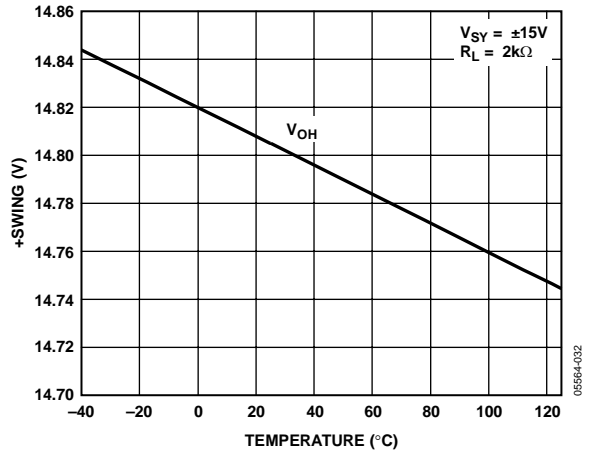

Figure 25. Swing vs. Temperature, V_{OH}

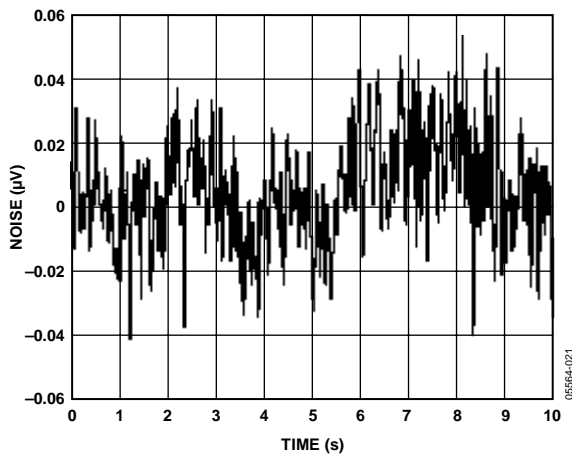

Figure 23. Voltage Noise (0.1 Hz to 10 Hz)

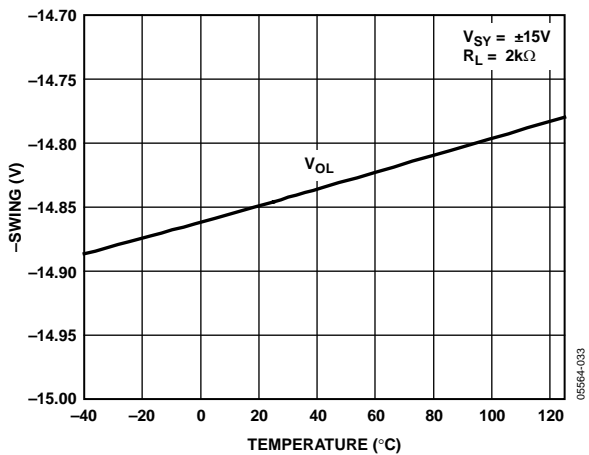

Figure 26. Swing vs. Temperature, V_{OL}

AD8675

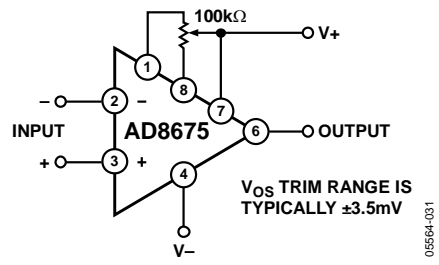

Figure 27. Optional Offset Nulling Circuit

OUTLINE DIMENSIONS

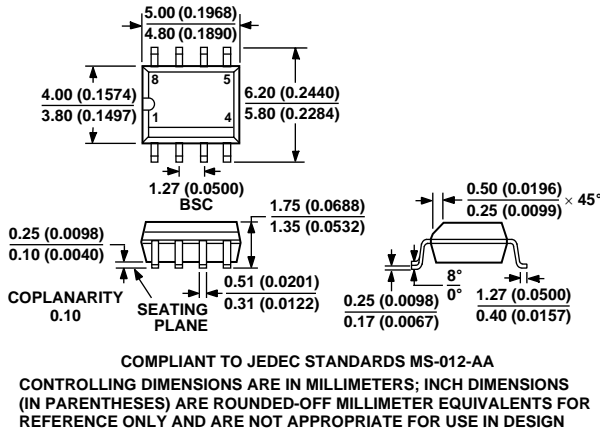

Figure 28. 8-Lead Standard Small Outline Package [SOIC_N] Narrow Body (R-8)
Dimensions shown in millimeters and (inches)

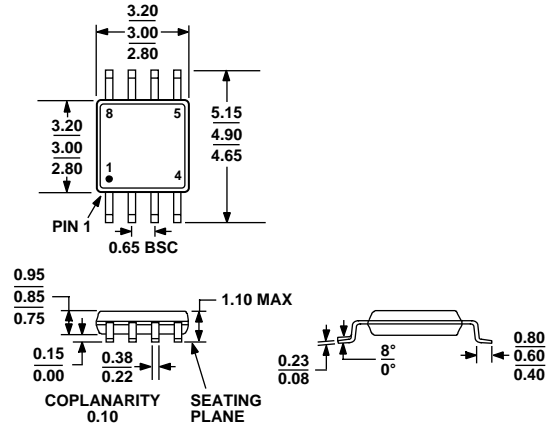

Figure 29. 8-Lead Mini Small Outline Package [MSOP] (RM-8)
Dimensions shown in millimeters

ORDERING GUIDE

Model	Temperature Range	Package Description	Package Option	Branding
AD8675ARMZ-R2 ¹	-40°C to +125°C	8-Lead Mini Small Outline Package [MSOP]	RM-8	A08
AD8675ARMZ-REEL ¹	-40°C to +125°C	8-Lead Mini Small Outline Package [MSOP]	RM-8	A08
AD8675ARZ ¹	-40°C to +125°C	8-Lead Standard Small Outline Package [SOIC_N]	R-8	
AD8675ARZ-REEL ¹	-40°C to +125°C	8-Lead Standard Small Outline Package [SOIC_N]	R-8	
AD8675ARZ-REEL7 ¹	-40°C to +125°C	8-Lead Standard Small Outline Package [SOIC_N]	R-8	

¹ Z = Pb-free part.

AD8675

NOTES