



# EPITAXIAL-BASE NPN/PNP

## POWER DARLINGTONS

The BDX 53, BDX 53A, BDX 53B and BDX 53C are silicon epitaxial-base NPN transistors in monolithic Darlington configuration and are mounted in Jedec TO-220 plastic package, intended for use in hammer drivers, audio amplifiers and other medium power linear and switching applications.

The complementary PNP types are the BDX 54, BDX 54A, BDX 54B and BDX 54C respectively.

ABSOLUTE MAXIMUM RATINGS		NPN PNP*	BDX53 BDX54	BDX53A BDX54A	BDX53B BDX54B	BDX53C BDX54C
$V_{CBO}$	Collector-base voltage ( $I_E = 0$ )		45V	60V	80V	100V
$V_{CEO}$	Collector-emitter voltage ( $I_B = 0$ )		45V	60V	80V	100V
$V_{EBO}$	Emitter-base voltage ( $I_C = 0$ )				5V	
$I_C$	Collector current				8A	
$I_{CM}$	Collector peak current (repetitive)				12A	
$I_B$	Base current				0.2A	
$P_{tot}$	Total power dissipation at $T_{case} \leq 25^\circ C$				60W	
$T_{stg}$	Storage temperature				-65 to 150°C	
$T_J$	Junction temperature				150°C	

\* For PNP types voltage and current values are negative

## INTERNAL SCHEMATIC DIAGRAMS

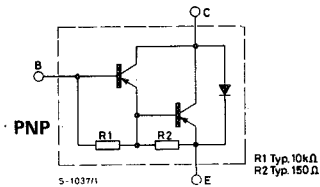
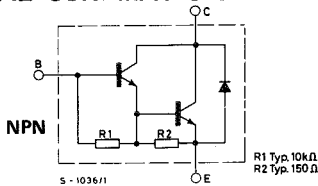

## MECHANICAL DATA

Dimensions in mm

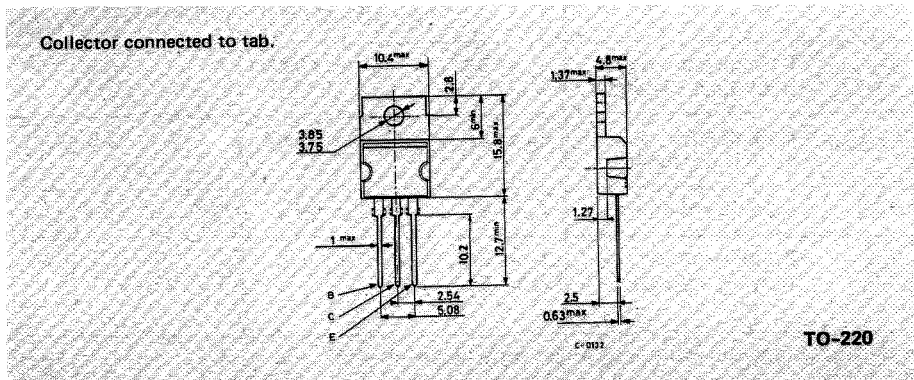

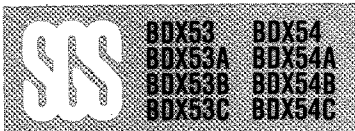

### THERMAL DATA

$R_{th\ j-case}$	Thermal resistance junction-case	max	2.08 °C/W
$R_{th\ j-amb}$	Thermal resistance junction-ambient	max	70 °C/W

### ELECTRICAL CHARACTERISTICS ( $T_{case} = 25^{\circ}C$ unless otherwise specified)

Parameter	Test conditions	Min.	Typ.	Max.	Unit
$I_{CBO}$	Collector cutoff current ( $I_E = 0$ )	for <b>BDX53/54</b> $V_{CB} = 45V$ for <b>BDX53A/54A</b> $V_{CB} = 60V$ for <b>BDX53B/54B</b> $V_{CB} = 80V$ for <b>BDX53C/54C</b> $V_{CB} = 100V$		200	$\mu A$
$I_{CEO}$	Collector cutoff current ( $I_B = 0$ )	for <b>BDX53/54</b> $V_{CE} = 22V$ for <b>BDX53A/54A</b> $V_{CE} = 30V$ for <b>BDX53B/54B</b> $V_{CE} = 40V$ for <b>BDX53C/54C</b> $V_{CE} = 50V$		500	$\mu A$
$I_{EBO}$	Emitter cutoff current ( $I_C = 0$ )	$V_{EB} = 5 V$		2	mA
$V_{CEO(sus)}$ *	Collector-emitter sustaining voltage ( $I_B = 0$ )	$I_C = 100 mA$ for <b>BDX53/54</b> for <b>BDX53A/54A</b> for <b>BDX53B/54B</b> for <b>BDX53C/54C</b>	45 60 80 100		V
$V_{CE(sat)}$ *	Collector-emitter saturation voltage	$I_C = 3A$ $I_B = 12mA$		2	V
$V_{BE(sat)}$ *	Base-emitter saturation voltage	$I_C = 3A$ $I_B = 12mA$		2.5	V
$h_{FE}$ *	DC current gain	$I_C = 3A$ $V_{CE} = 3V$	750		—
$V_F$	Parallel-diode forward voltage	$I_F = 3A$ $I_F = 8A$	1.8 2.5	2.5	V

\* Pulsed: pulse duration = 300  $\mu s$ , duty cycle = 1.5%

For PNP types voltage and current values are negative



Safe operating area

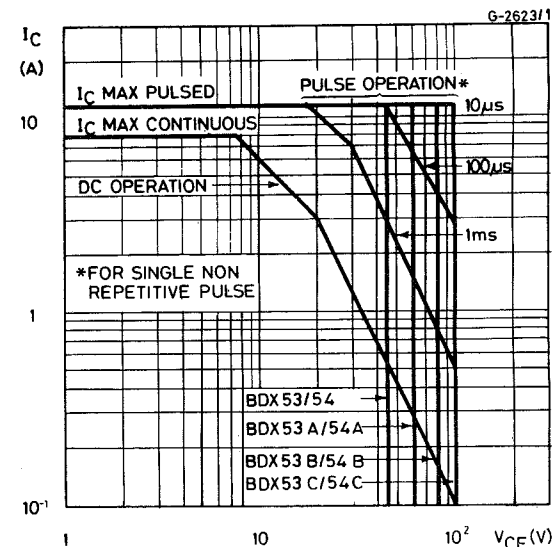

For the other characteristics curves see TIP120/TIP125 series.



# EPITAXIAL-BASE NPN/PNP

## POWER DARLINGTONS

The TIP120, TIP121 and TIP122 are silicon epitaxial-base NPN transistors in monolithic Darlington configuration in Jedec TO-220 plastic package, intended for use in power linear and switching applications.

The complementary PNP types are the TIP125, TIP126 and TIP127 respectively.

### ABSOLUTE MAXIMUM RATINGS

	NPN PNP*	TIP120 TIP125	TIP121 TIP126	TIP122 TIP127
$V_{CBO}$	Collector-base voltage ( $I_E = 0$ )	60V	80V	100V
$V_{CEO}$	Collector-emitter voltage ( $I_B = 0$ )	60V	80V	100V
$V_{EBO}$	Emitter-base voltage ( $I_C = 0$ )		5V	
$I_C$	Collector current		5A	
$I_{CM}$	Collector peak current		8A	
$I_B$	Base current		0.1A	
$P_{tot}$	Total power dissipation at $T_{case} \leq 25^\circ C$ $T_{amb} \leq 25^\circ C$		65W	2W
$T_{stg}$	Storage temperature		-65 to 150°C	
$T_J$	Junction temperature		150°C	

\* For PNP types voltage and current values are negative.

### INTERNAL SCHEMATIC DIAGRAMS

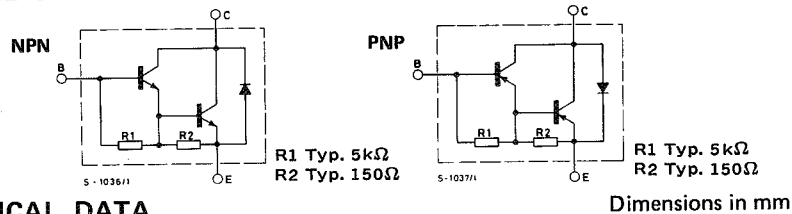

### MECHANICAL DATA

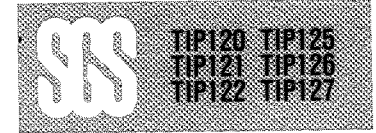
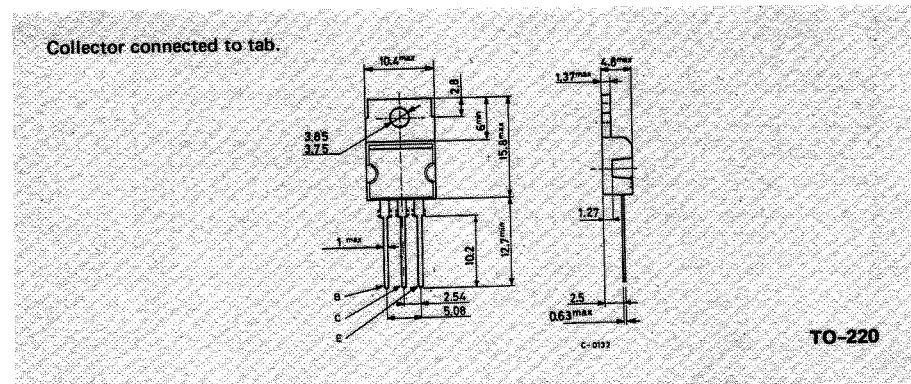

## THERMAL DATA

$R_{th\ j-case}$	Thermal resistance junction-case	max	1.92	°C/W
$R_{th\ j-amb}$	Thermal resistance junction-ambient	max	62.5	°C/W

## ELECTRICAL CHARACTERISTICS ( $T_{case} = 25^\circ C$ unless otherwise specified)

Parameter	Test conditions	Min.	Typ.	Max.	Unit
$I_{CEO}$	Collector cutoff current ( $I_B = 0$ )			0.5	mA
	for TIP120/5 $V_{CE} = 30V$ for TIP121/6 $V_{CE} = 40V$ for TIP122/7 $V_{CE} = 50V$			0.5	mA
$I_{CBO}$	Collector cutoff current ( $I_E = 0$ )			0.2	mA
	for TIP120/5 $V_{CB} = 60V$ for TIP121/6 $V_{CB} = 80V$ for TIP122/7 $V_{CB} = 100V$			0.2	mA
$I_{EBO}$	Emitter cutoff current ( $I_C = 0$ )			2	mA
$V_{CEO(sus)}$	Collector-emitter sustaining voltage ( $I_B = 0$ )	60	80	100	V
	$I_C = 30mA$ for TIP120/5 for TIP121/6 for TIP122/7				V
$V_{CE(sat)}$	Collector-emitter saturation voltage			2	V
	$I_C = 3A$ $I_B = 12mA$ $I_C = 5A$ $I_B = 20mA$			4	V
$V_{BE(on)}$	Base-emitter voltage			2.5	V
	$I_C = 3A$ $V_{CE} = 3V$				V
$h_{FE}$	DC current gain	1000			-
	$I_C = 0.5A$ $V_{CE} = 3V$ $I_C = 3A$ $V_{CE} = 3V$	1000			-

\* Pulsed: pulse duration = 300 $\mu s$ , duty cycle  $\leq 2\%$

Safe operating areas

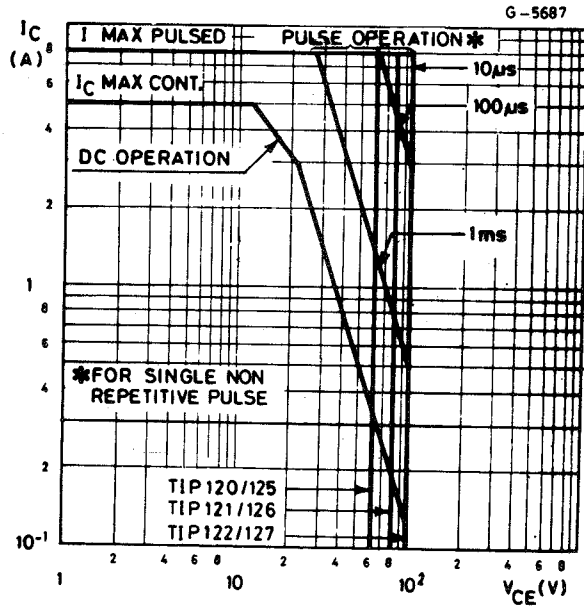

Collector-emitter saturation voltage (NPN types)

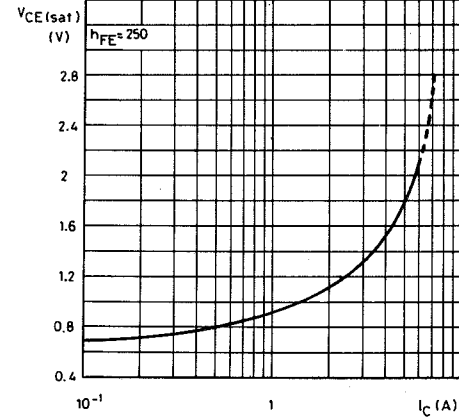

Collector-emitter saturation voltage (PNP types)

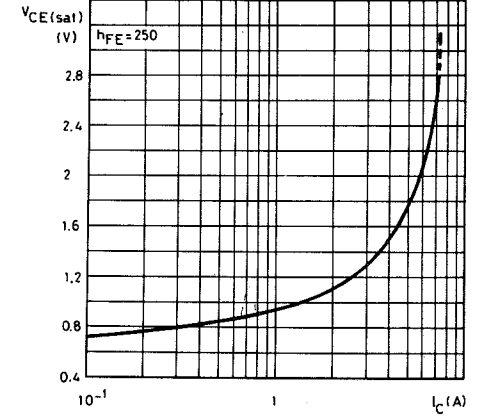

DC current gain (NPN types)

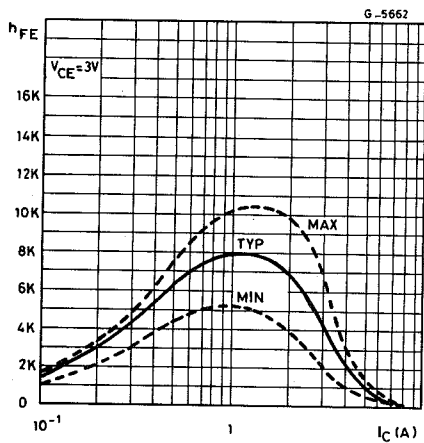

DC current gain (PNP types)

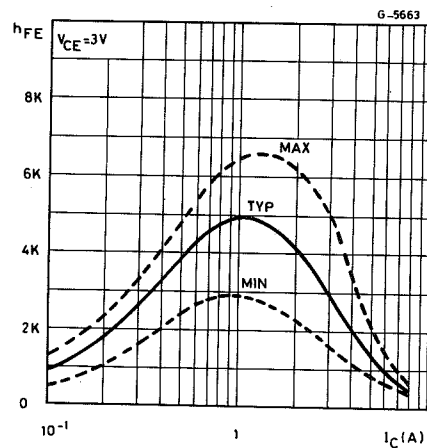

Base-emitter saturation voltage (NPN types)

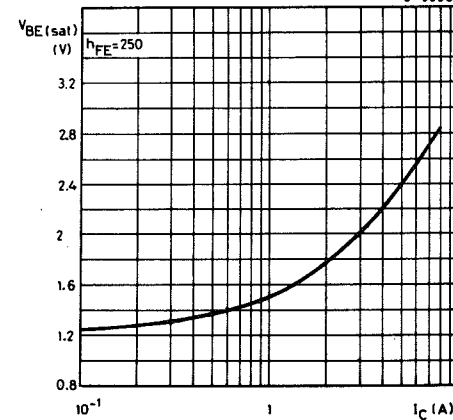

Base-emitter saturation voltage (PNP types)

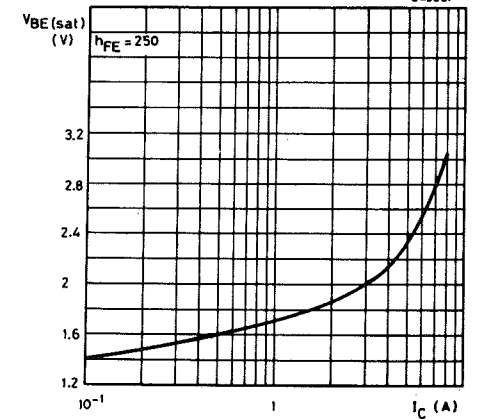



TIP120 TIP125  
TIP121 TIP126  
TIP122 TIP127

Base-emitter voltage (NPN types)

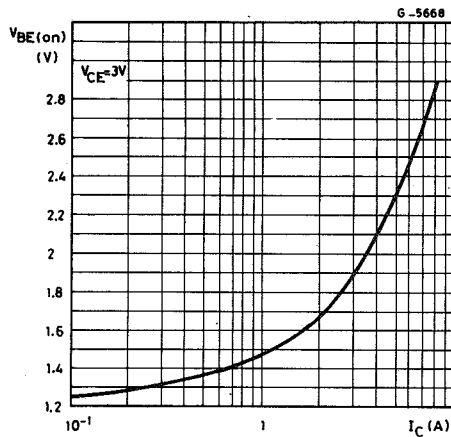

Base-emitter voltage (PNP types)

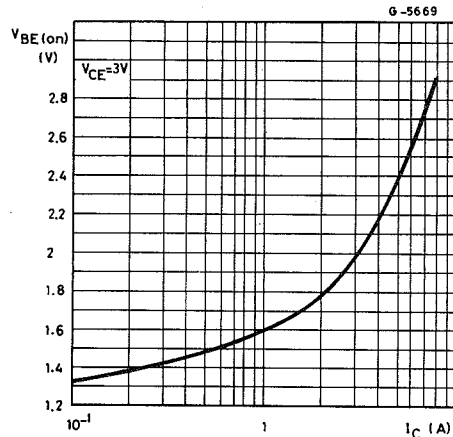

Freewheel diode forward voltage (NPN types)

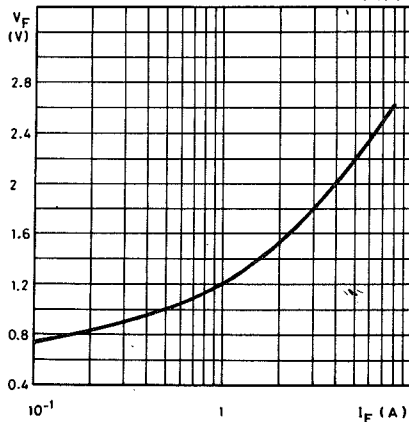

Freewheel diode forward voltage (PNP types)

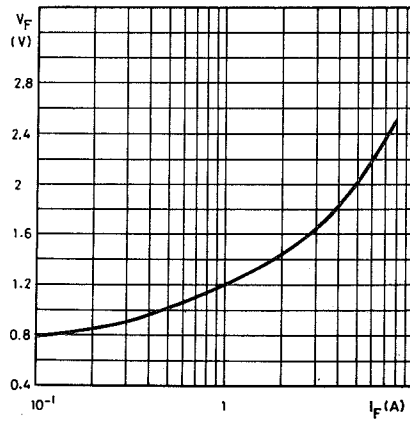

Switching times vs.  $T_{case}$  resistive load (NPN types)

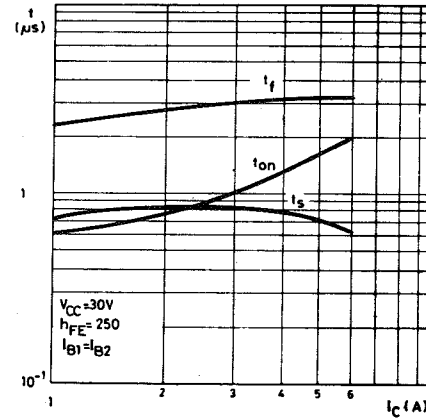

Switching times vs.  $T_{case}$  resistive load (PNP types)

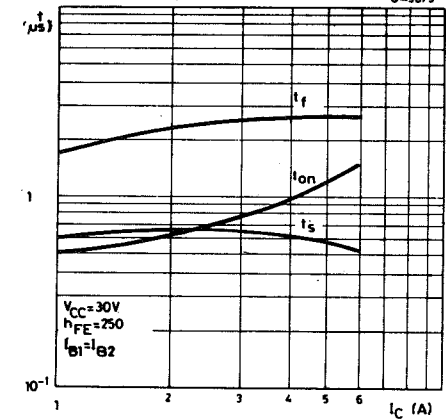

Derating curve

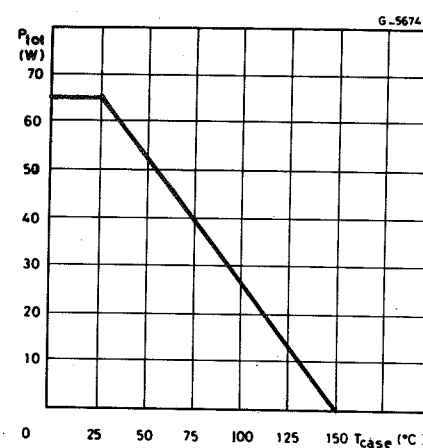

Free-air temperature derating curve

