

# AMMP-6220

## 6-20 GHz Low Noise Amplifier

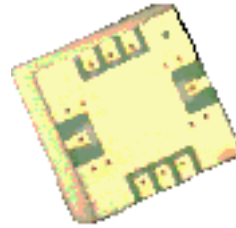

### Data Sheet



#### Description

Avago's AMMP-6220 is a high gain, low-noise amplifier that operates from 6 GHz to 20 GHz. The LNA is designed to be a easy-to-use component for any surface mount PCB application. The broad and unconditionally stable performance makes this LNA ideal for primary, sub-sequential or driver low noise gain stages. Intended applications include microwave radios, 802.16, automotive radar, VSAT, and satellite receivers. Since one part can cover several bands, the AMMP-6220 can reduce part inventory and increase volume purchase options. The LNA has integrated 50 Ω I/O match, DC blocking, self-bias and choke to eliminate complex tuning and assembly processes typically required by hybrid (discrete-FET) amplifiers. The package is full SMT compatible with backside grounding and I/O to simplify assembly.

#### Features

- 5x5 mm surface mount package
- Broad Band performance 6-20 GHz
- Low 2.5 dB typical noise figure
- High 22 dB typical gain
- 50 Ω input and output match
- Single 3 V (55 mA) supply bias

#### Applications

- Microwave radio systems
- Satellite VSAT, DBS up/down link
- LMDS & Pt-Pt mmW Long Haul
- Broadband Wireless Access (including 802.16 and 802.20 WiMax)
- WLL and MMDS loops
- Commercial grade military

#### Functional Diagram

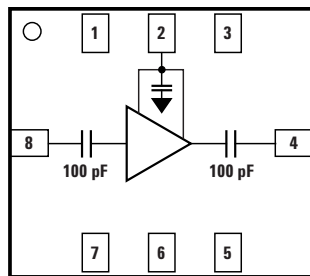

PIN	FUNCTION
1	
2	V <sub>d</sub>
3	
4	RF <sub>out</sub>
5	
6	
7	
8	RF <sub>in</sub>

PACKAGE  
BASE  
GND



Attention: Observe precautions for handling electrostatic sensitive devices.

ESD Machine Model (Class 1A)

ESD Human Body Model (Class 0)

Refer to Avago Application Note A004R: **Electrostatic Discharge Damage and Control.**

**AMMP-6220 Absolute Maximum Ratings [1]**

Symbol	Parameters/Conditions	Units	Min.	Max.
$V_d$	Positive Drain Voltage	V		7
$I_d$	Drain Current	mA		100
$P_{in}$	CW Input Power	dBm		15
$T_{ch}$	Operating Channel Temp.	°C		+150
$T_{stg}$	Storage Case Temp.	°C	-65	+150
$T_{max}$	Maximum Assembly Temp. (60 sec max.)	°C		+300

**Note:**

1. Operation in excess of any one of these conditions may result in permanent damage to this device.

**AMMP-6220 DC Specifications/Physical Properties [1]**

Symbol	Parameters and Test Conditions	Units	Min.	Typ.	Max.
$I_d$	Drain Supply Current (under any RF power drive and temperature) ( $V_d = 3.0$ V)	mA		55	70
$\theta_{ch-b}$	Thermal Resistance <sup>[2]</sup> (Backside temperature, $T_b = 25^\circ\text{C}$ )	°C/W		27	

**Notes:**

- Ambient operational temperature  $T_A = 25^\circ\text{C}$  unless otherwise noted.
- Channel-to-backside Thermal Resistance ( $T_{channel} (T_c) = 34^\circ\text{C}$ ) as measured using infrared microscopy. Thermal Resistance at backside temperature ( $T_b = 25^\circ\text{C}$ ) calculated from measured data.

**AMMP-6220 RF Specifications [3, 4, 6]**

$T_A = 25^\circ\text{C}$ ,  $V_d = 3.0$  V,  $I_{d(Q)} = 55$  mA,  $Z_o = 50 \Omega$

Symbol	Parameters and Test Conditions	Units	Typical	Sigma
Gain	Small-signal Gain <sup>[5]</sup>	dB	22	0.5
NF	Noise Figure into $50 \Omega$ <sup>[5]</sup>	dB	2.5	0.2
$P_{-1dB}$	Output Power at 1dB Gain Compression	dBm	+10	0.8
OIP3	Third Order Intercept Point; $\Delta f = 100$ MHz; $P_{in} = -20$ dBm	dBm	+20	1.1
RLin	Input Return Loss	dB	-12	0.3
RLout	Output Return Loss	dB	-16	0.7
Isol	Reverse Isolation	dB	-45	0.5

**Notes:**

- Small/Large -signal data measured in a fully de-embedded test fixture form  $T_A = 25^\circ\text{C}$ .
- Pre-assembly into package performance verified 100% on-wafer per AMMC-6220 published specifications.
- This final package part performance is verified by a functional test correlated to actual performance at one or more frequencies.
- Specifications are derived from measurements in a  $50 \Omega$  test environment. Aspects of the amplifier performance may be improved over a more narrow bandwidth by application of additional conjugate, linearity, or low noise ( $\Gamma_{opt}$ ) matching.

**AMMP-6220 Typical Performances** ( $T_A = 25^\circ\text{C}$ ,  $V_d = 3\text{ V}$ ,  $I_D = 55\text{ mA}$ ,  $Z_{in} = Z_{out} = 50\ \Omega$  unless otherwise stated)

**Note:** These measurements are in  $50\ \Omega$  test environment. Aspects of the amplifier performance may be improved over a narrower bandwidth by application of additional conjugate, linearity or low noise ( $\Gamma_{opt}$ ) matching.

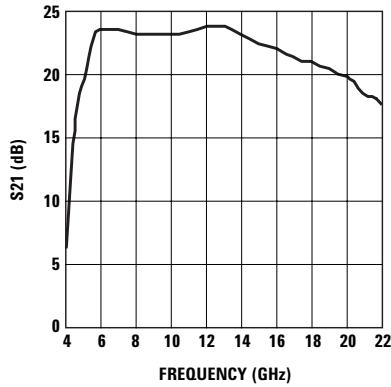

Figure 1. Gain.

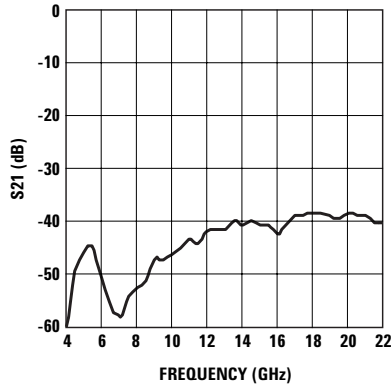

Figure 2. Isolation.

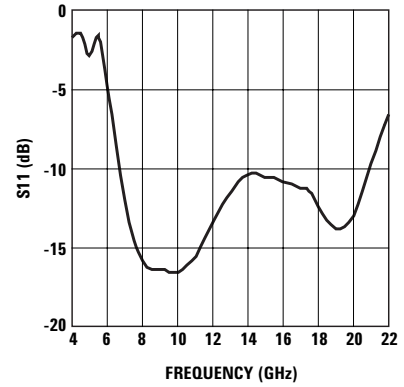

Figure 3. Input return loss.

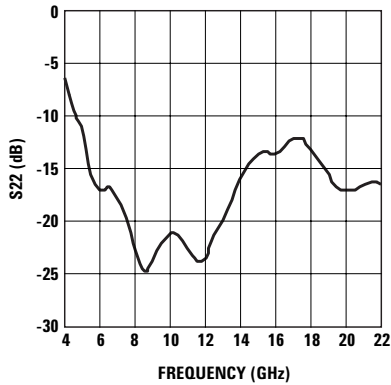

Figure 4. Output return loss.

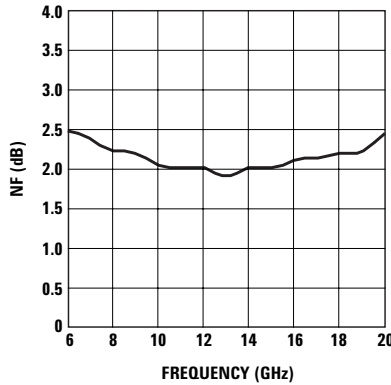

Figure 5. Noise figure.

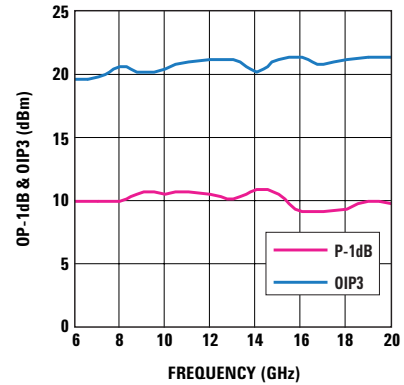

Figure 6. Typical power, OP-1dB and OIP3.

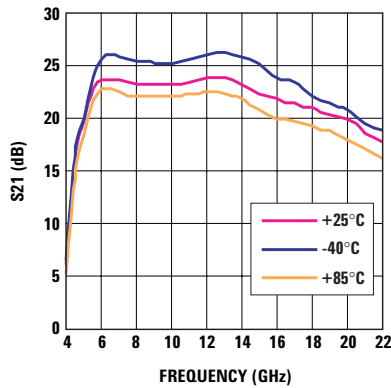

Figure 7. Gain over temperature.

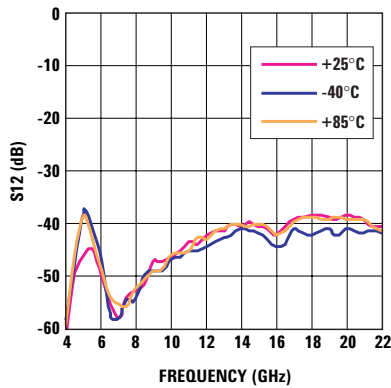

Figure 8. Isolation over temperature.

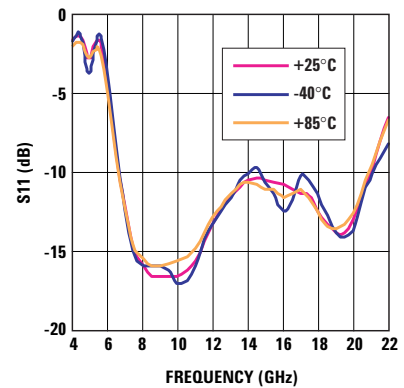

Figure 9. Input return loss over temperature.

**AMMP-6220 Typical Performances** ( $T_A = 25^\circ\text{C}$ ,  $V_d = 3\text{ V}$ ,  $I_D = 55\text{ mA}$ ,  $Z_{in} = Z_{out} = 50\ \Omega$  unless otherwise stated)

**Note:** These measurements are in  $50\ \Omega$  test environment. Aspects of the amplifier performance may be improved over a narrower bandwidth by application of additional conjugate, linearity or low noise ( $\Gamma_{opt}$ ) matching.

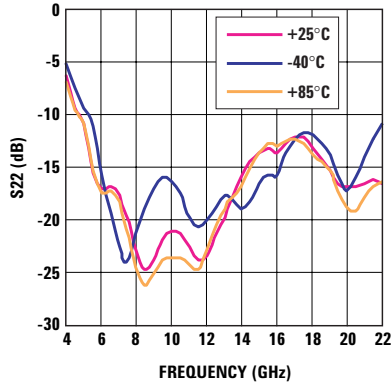

Figure 10. Output return loss over temperature.

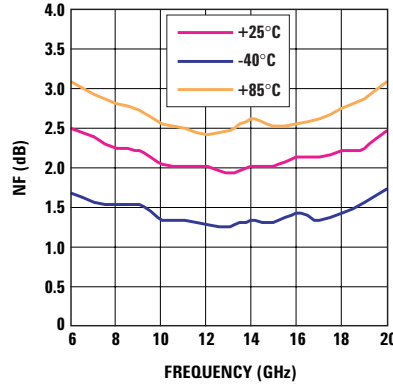

Figure 11. NF over temperature.

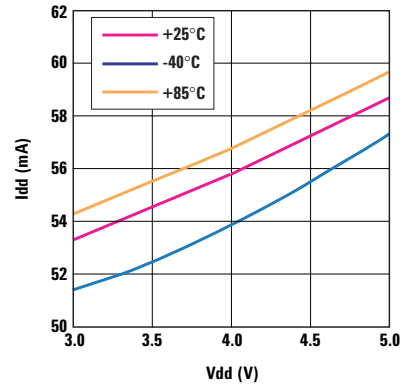

Figure 12. Bias current over temperature.

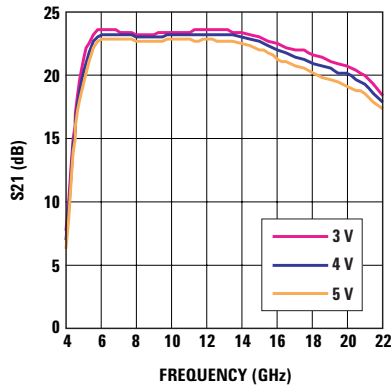

Figure 13. Gain over Vdd.

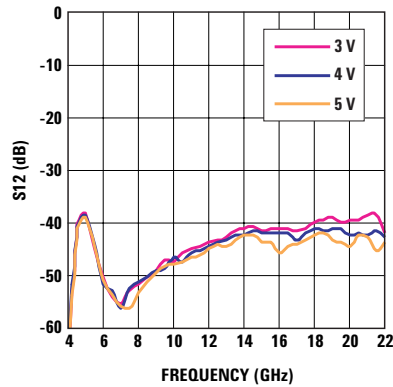

Figure 14. Isolation over Vdd.

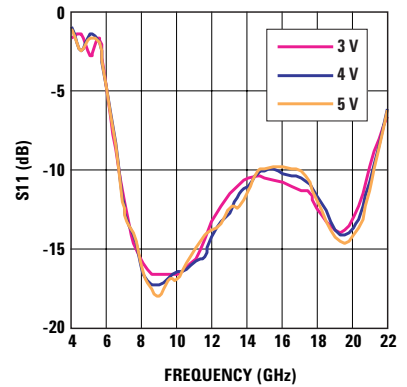

Figure 15. Input RL over Vdd.

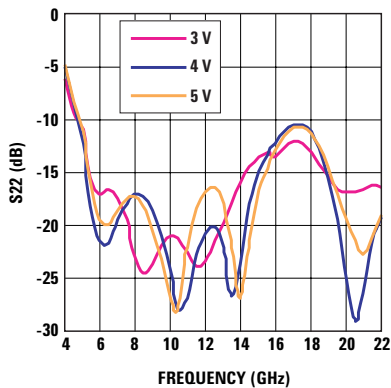

Figure 16. Output return loss over temperature.

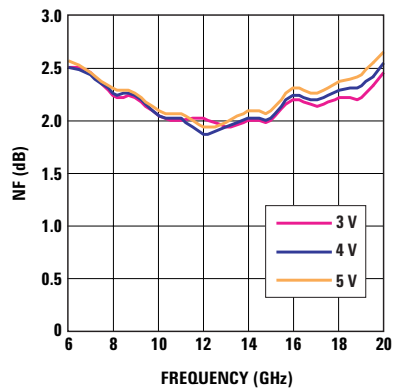

Figure 17. Noise figure over Vdd.

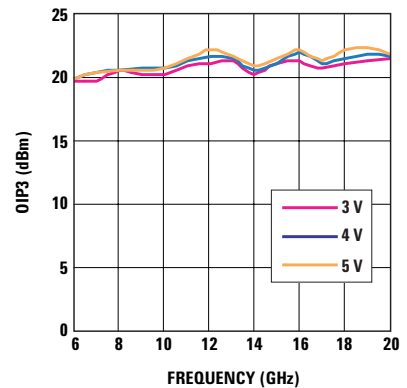
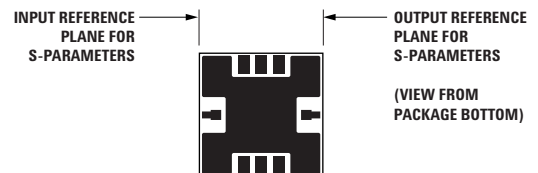

Figure 18. OIP3 over Vdd.

**AMMP-6220 Typical Scattering Parameters<sup>[1]</sup>** ( $T_A = 25^\circ\text{C}$ ,  $V_d = 3\text{ V}$ ,  $Z_o = 50\ \Omega$ )

Freq GHz	S11			S21			S12			S22		
	DB	Mag	Phase	dB	Mag	Phase	dB	Mag	Phase	dB	Mag	Phase
2.0	-1.46	0.845	65.6	-28.9	0.036	-62.0	-60	0.001	70.9	-4.8	0.570	85.5
2.5	-1.03	0.888	-4.4	-10.6	0.292	-147.1	-51	0.003	12.1	-9.6	0.330	38.7
3.0	-0.40	0.955	-83.9	6.1	2.027	96.8	-46	0.005	-72.	-8.8	0.361	18.1
3.5	-4.65	0.585	-150.2	10.6	3.420	-71.3	-56	0.001	136.7	-6.3	0.483	-46.1
4.0	-1.67	0.825	153.6	6.2	2.051	-104.2	-61	0.001	143.5	-6.1	0.491	-118.9
4.5	-1.39	0.851	72.8	16.6	6.764	-178.3	-49	0.003	-86.3	-9.3	0.342	174.4
5.0	-2.80	0.724	18.7	19.6	9.563	93.3	-45	0.005	140.2	-10.8	0.286	125.8
5.5	-1.59	0.832	-65.0	22.8	13.836	9.3	-44	0.006	26.4	-15.5	0.166	79.4
6.0	-4.66	0.585	-144.6	23.5	15.077	-72.4	-50	0.003	-66.8	-16.9	0.141	64.2
6.5	-8.62	0.370	148.4	23.6	15.218	-145.1	-55	0.002	-116.2	-16.7	0.146	31.4
7.0	-11.96	0.252	93.4	23.6	15.198	150.4	-58	0.001	153.4	-17.5	0.132	-8.7
7.5	-14.57	0.187	48.4	23.3	14.717	90.5	-54	0.002	89.9	-19.5	0.106	-51.8
8.0	-15.90	0.160	12.5	23.2	14.575	33.6	-52	0.002	33.2	-22.7	0.073	-103.7
8.5	-16.48	0.150	-21.7	23.1	14.429	-20.9	-51	0.003	-16.5	-24.6	0.059	-172.2
9.0	-16.49	0.150	-58.8	23.1	14.408	-74.7	-47	0.004	-46.2	-23.7	0.065	119.7
9.5	-16.53	0.149	-100.8	23.2	14.455	-126.9	-47	0.004	-85.8	-21.9	0.080	70.3
10.0	-16.56	0.149	-147.1	23.2	14.462	-178.2	-46	0.005	-121.8	-21.0	0.089	31.0
10.5	-16.19	0.155	161.1	23.3	14.624	131.2	-45	0.006	-155.9	-21.3	0.086	-3.6
11.0	-15.63	0.165	108.2	23.4	14.926	80.4	-43	0.007	159.4	-22.6	0.074	-29.9
11.5	-14.36	0.191	54.8	23.6	15.226	29.4	-44	0.006	130.7	-23.8	0.064	-46.2
12.0	-13.22	0.218	3.0	23.8	15.497	-20.8	-42	0.008	88.0	-23.4	0.067	-59.0
12.5	-12.30	0.242	-50.7	23.7	15.483	-72.0	-41	0.008	49.2	-21.3	0.086	-90.7
13.0	-11.45	0.268	-102.0	23.7	15.450	-122.8	-41	0.008	14.5	-19.7	0.102	-130.4
13.5	-10.83	0.287	-154.6	23.6	15.143	-173.1	-40	0.010	-26.9	-17.8	0.127	179.7
14.0	-10.47	0.299	153.2	23.2	14.518	135.7	-40	0.009	-66.8	-16.0	0.157	128.3
14.5	-10.32	0.305	101.7	22.7	13.724	87.2	-39	0.010	-104.7	-14.4	0.189	79.9
15.0	-10.53	0.297	52.2	22.3	13.168	38.7	-40	0.009	-146.3	-13.5	0.211	34.8
15.5	-10.62	0.294	8.9	22.1	12.858	-8.5	-40	0.009	174.6	-13.2	0.218	-4.6
16.0	-10.79	0.289	-33.2	21.9	12.536	-56.2	-42	0.008	138.1	-13.6	0.208	-38.0
16.5	-10.97	0.283	-67.4	21.5	11.970	-102.6	-40	0.009	116.4	-12.7	0.231	-65.0
17.0	-11.25	0.274	-109.8	21.4	11.796	-151.3	-39	0.011	77.9	-12.1	0.247	-101.8
17.5	-11.47	0.267	-152.2	21.0	11.331	162.1	-38	0.012	38.0	-12.1	0.246	-140.0
18.0	-12.36	0.241	168.0	20.9	11.208	115.8	-38	0.012	-5.3	-13.1	0.220	179.3
18.5	-13.30	0.217	132.5	20.6	10.720	69.0	-38	0.012	-40.0	-14.2	0.194	139.1
19.0	-13.86	0.203	99.5	20.4	10.474	21.3	-38	0.012	-82.3	-15.4	0.170	94.9
19.5	-13.77	0.205	67.3	20.1	10.158	-25.9	-39	0.011	-118.5	-16.5	0.148	44.7
20.0	-12.94	0.225	32.0	19.8	9.847	-74.5	-38	0.012	-161.5	-16.8	0.144	-5.1
20.5	-11.42	0.268	-6.3	19.4	9.413	-121.1	-39	0.011	162.1	-16.8	0.143	-51.5
21.0	-9.73	0.326	-49.1	18.5	8.500	-169.0	-39	0.011	124.7	-16.5	0.148	-92.9
21.5	-8.00	0.398	-94.4	18.2	8.140	142.8	-40	0.010	79.8	-16.1	0.156	-132.8
22.0	-6.54	0.471	-140.6	17.7	7.703	93.3	-40	0.010	35.1	-16.5	0.149	-167.4
22.5	-5.44	0.534	173.4	16.9	7.055	45.0	-41	0.009	2.9	-17.3	0.136	159.4
23.0	-5.12	0.554	128.5	16.3	6.535	-3.1	-43	0.007	-41.2	-21.9	0.080	138.2
23.5	-4.72	0.581	86.1	15.3	5.881	-54.0	-45	0.005	-84.6	-18.0	0.126	178.1
24.0	-4.17	0.618	44.3	13.7	4.894	-102.8	-47	0.004	-136.3	-11.5	0.265	141.6
24.5	-3.40	0.675	0.9	12.6	4.288	-147.1	-49	0.003	-162.8	-9.0	0.355	100.9
25.0	-2.65	0.737	-44.6	11.6	3.822	168.3	-50	0.003	134.1	-7.7	0.409	61.8

Note: Data obtained from ICM fixture measurements fully de-embedded to package edge.



### Biasing and Operation

The AMMC-6220 is normally biased with a single positive drain supply connected to both  $V_D$  pin through bypass capacitors as shown in Figure 19. The recommended supply voltage is 3 V. It is important to have 0.1  $\mu\text{F}$  bypass capacitor, and the capacitor should be placed as close to the component as possible.

The AMMC-6220 does not require a negative gate voltage to bias any of the three stages. No ground wires are needed because all ground connections are made with plated through-holes to the backside of the package.

Refer the Absolute Maximum Ratings table for allowed DC and thermal conditions.

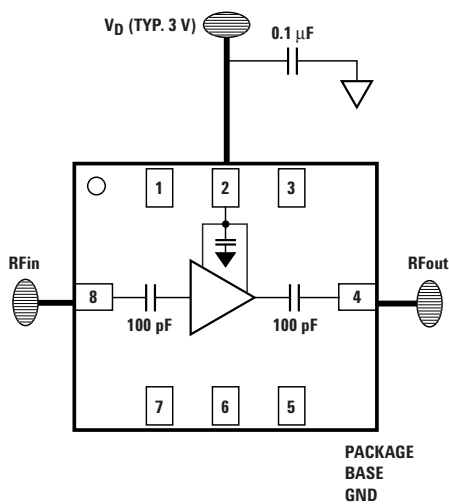

Figure 19. Typical application.

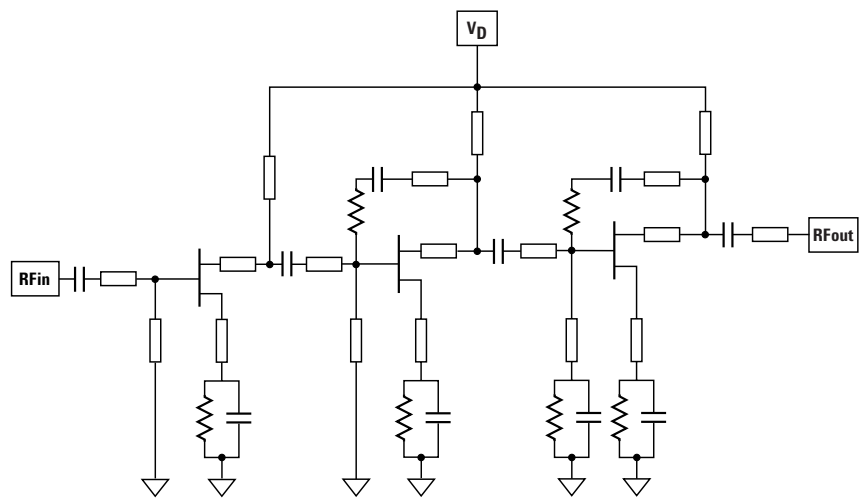

Figure 20. Simplified MMIC schematic.

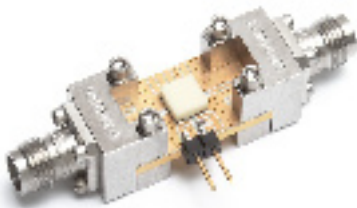
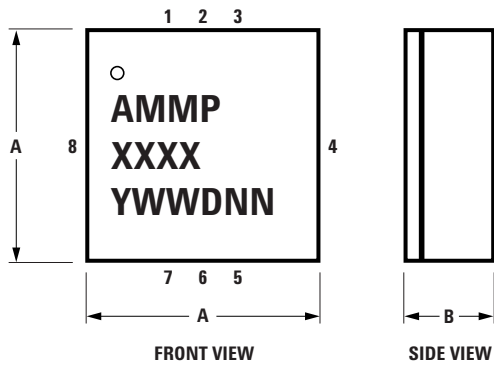

Figure 21. Demonstration board (available upon request).

Outline Drawing



SYMBOL	MIN.	MAX.
A	0.198 (5.03)	0.213 (5.4)
B	0.0685 (1.74)	0.088 (2.25)

DIMENSIONS ARE IN INCHES (MM)

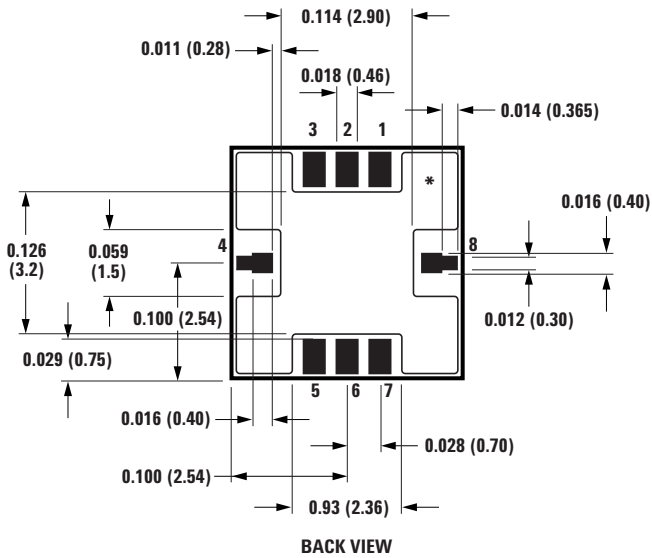

DIMENSIONAL TOLERANCE FOR BACK VIEW: 0.002" (0.05 mm)

NOTES:

1. \* INDICATES PIN 1
2. DIMENSIONS ARE IN INCHES (MILLIMETERS)
3. ALL GROUNDS MUST BE SOLDERED TO PCB RF GROUND

Figure 22. Outline Drawing.

### Recommended SMT Attachment

The AMMP Packaged Devices are compatible with high volume surface mount PCB assembly processes.

The PCB material and mounting pattern, as defined in the data sheet, optimizes RF performance and is strongly recommended. An electronic drawing of the land pattern is available upon request from Avago Sales & Application Engineering.

### Stencil Design Guidelines

A properly designed solder screen or stencil is required to ensure optimum amount of solder paste is deposited

onto the PCB pads. The recommended stencil layout is shown in Figure 24. The stencil has a solder paste deposition opening approximately 70% to 90% of the PCB pad. Reducing stencil opening can potentially generate more voids underneath. On the other hand, stencil openings larger than 100% will lead to excessive solder paste smear or bridging across the I/O pads. Considering the fact that solder paste thickness will directly affect the quality of the solder joint, a good choice is to use a laser cut stencil composed of 0.127 mm (5 mils) thick stainless steel which is capable of producing the required fine stencil outline. The combined PCB and stencil layout is shown in Figure 25.

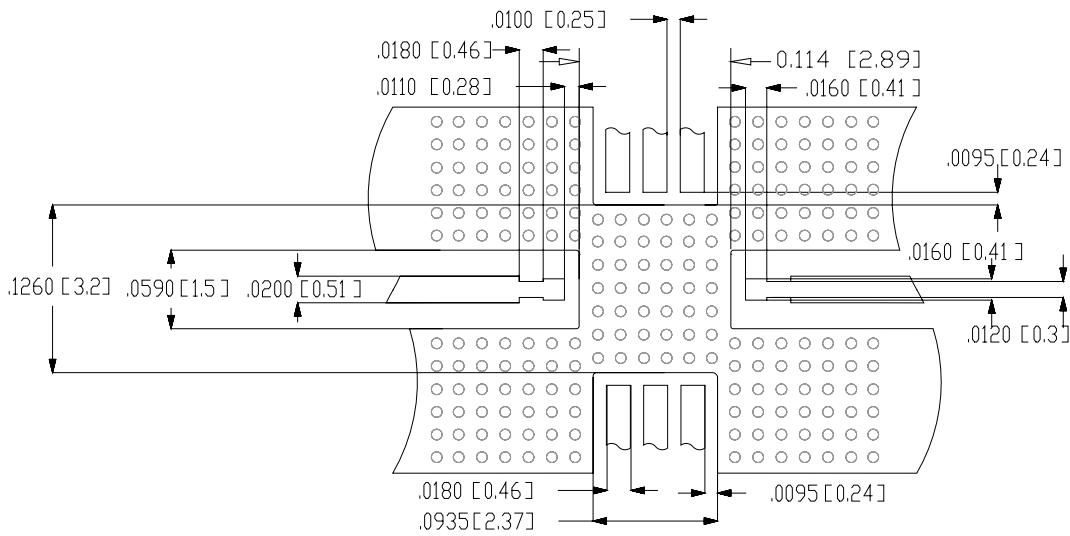

Figure 23. Suggested PCB Land Pattern and Stencil Layout

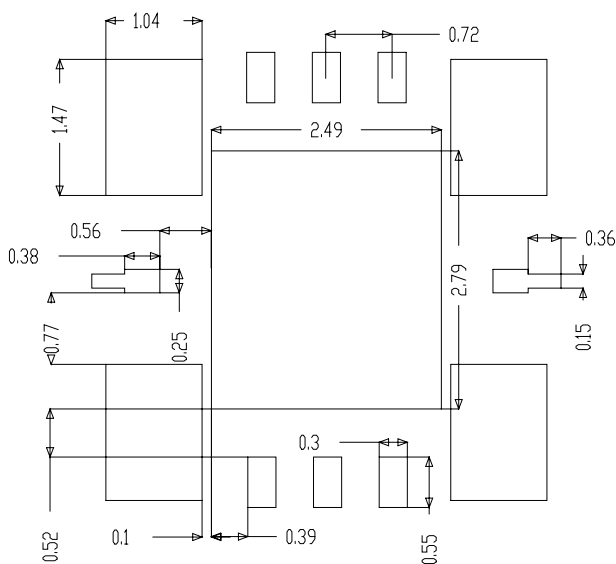

Figure 24. Stencil Outline Drawing (mm)

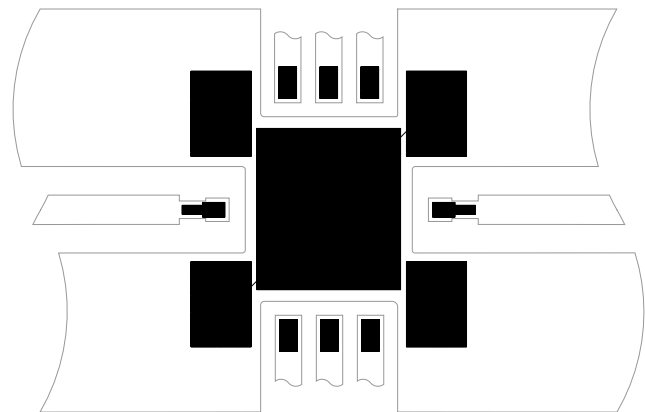

Figure 25. Combined PCB and Stencil Layouts



### Manual Assembly

1. Follow ESD precautions while handling packages.
2. Handling should be along the edges with tweezers.
3. Recommended attachment is conductive solder paste. Please see recommended solder reflow profile. Conductive epoxy is not recommended. Hand soldering is not recommended.
4. Apply solder paste using a stencil printer or dot placement. The volume of solder paste will be dependent on PCB and component layout and should be controlled to ensure consistent mechanical and electrical performance.
5. Follow solder paste and vendor's recommendations when developing a solder reflow profile. A standard profile will have a steady ramp up from room temperature to the pre-heat temperature to avoid damage due to thermal shock.
6. Packages have been qualified to withstand a peak temperature of 260°C for 20 seconds. Verify that the profile will not expose device beyond these limits.

### Solder Reflow Profile

The most commonly used solder reflow method is accomplished in a belt furnace using convection heat transfer. The suggested reflow profile for automated reflow processes is shown in Figure 26. This profile is designed to ensure reliable finished joints. However, the profile indicated in Figure 26 will vary among different solder pastes from different manufacturers and is shown here for reference only.

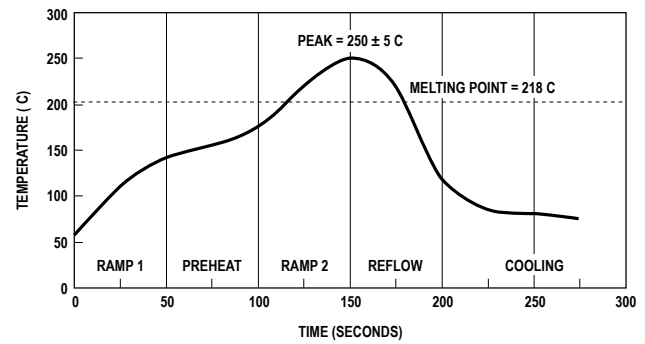
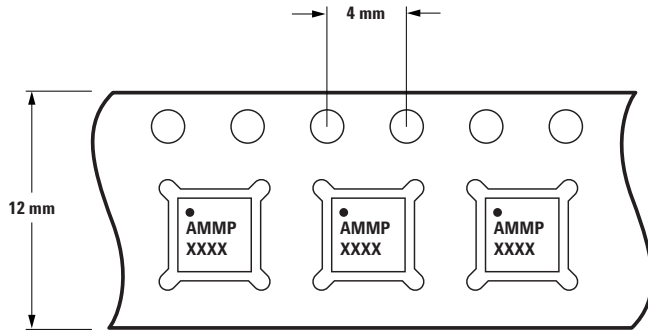

Figure 26. Suggested lead-free reflow profile for SnAgCu solder paste.

### AMMP-6220 Part Number Ordering Information

Part Number	Devices Per Container	Container
AMMP-6220-BLK	10	Antistatic bag
AMMP-6220-TR1	100	7" Reel
AMMP-6220-TR2	500	7" Reel

**Device Orientation (Top View)**



**Carrier Tape and Pocket Dimensions**

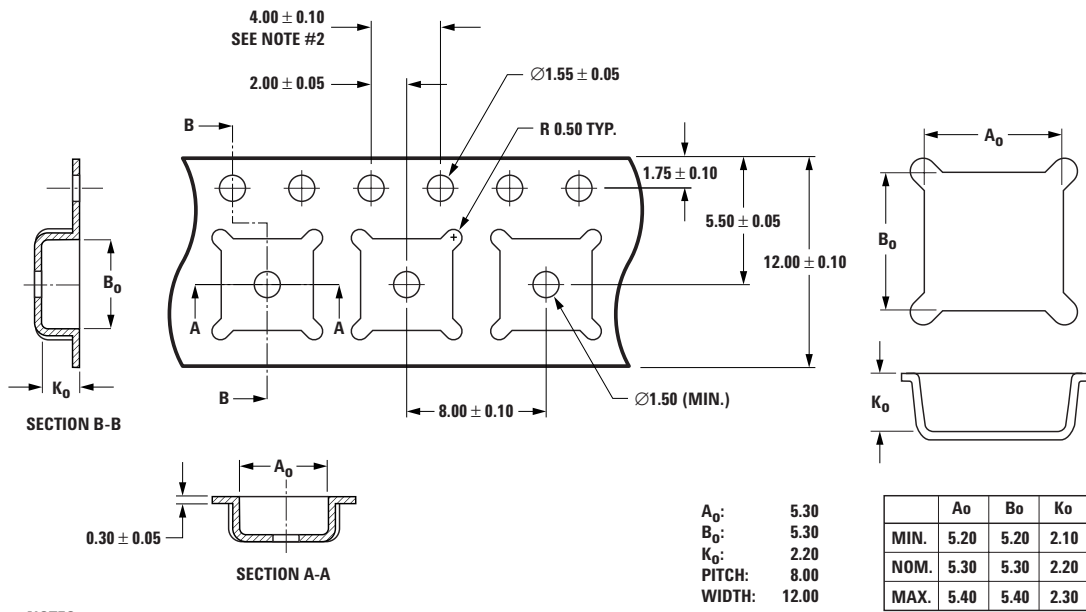

**NOTES:**

1. A<sub>0</sub> AND B<sub>0</sub> MEASURED AT 0.3 mm ABOVE BASE OF POCKET.
2. 10 PITCHES CUMULATIVE TOLERANCE IS ± 0.2 mm.
3. DIMENSIONS ARE IN MILLIMETERS (mm).

For product information and a complete list of distributors, please go to our website: [www.avagotech.com](http://www.avagotech.com)

Avago, Avago Technologies, and the A logo are trademarks of Avago Technologies Limited in the United States and other countries. Data subject to change. Copyright © 2007 Avago Technologies Limited. All rights reserved. Obsoletes 5989-4517EN AV02-0515EN - June 14, 2007

