

TS78M00LA Series

3-Terminal 500mA Positive Voltage Regulator

TO-220



TO-252 (DPAK)



Pin Definition:

1. Input
2. Ground (tab)
3. Output

General Description

The TS78M00LA Series positive voltage regulators are identical to the popular TS7800A Series devices, except that they are specified for only half the output current. Like the TS7800A devices, the TS78M00LA Series 3-Terminal regulators are intended for local, on-card voltage regulation.

Internal current limiting, thermal shutdown circuitry and safe-area compensation for the internal pass transistor combine to make these devices remarkably rugged under most operating conditions. Maximum output current with adequate heatsink is 500mA

This series is offered in 3-pin TO-220 & TO-252 package.

Features

- Output Voltage Range 5 to 24V
- Output current up to 500mA
- No external components required
- Internal thermal overload protection
- Internal short-circuit current limiting
- Output transistor safe-area compensation
- Output voltage offered in 2% tolerance

Ordering Information

Part No.	Package	Packing
TS78MxxLACZ C0	TO-220	50pcs / Tube
TS78MxxLACP RO	TO-252	2.5Kpcs / 13" Reel

Note: Where **xx** denote voltage option

Available Output Voltage: 05/06/08/09/10/12/15/18/24

Standard Application Circuit

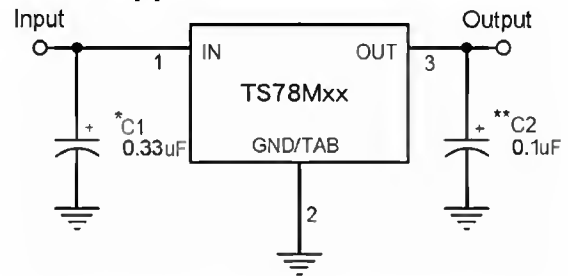

A common ground is required between the input and the output voltages. The input voltage must remain typically 2.0V above the output voltage even during the low point on the Input ripple voltage.

XX = these two digits of the type number indicate voltage.

* = Cin is required if regulator is located an appreciable distance from power supply filter.

** = Co is not needed for stability; however, it does improve transient response.

Absolute Maximum Rating (Ta = 25°C unless otherwise noted)

Parameter	Symbol	Limit	Unit
Input Voltage	V _{IN} *	35	V
Input Voltage	V _{IN} **	40	V
Power Dissipation	P _D	Internal Limited	W
Operating Junction Temperature	T _J	0~+125	°C
Storage Temperature Range	T _{STG}	-65~+150	°C

Note: * TS78M05LA to TS78M18LA

** TS78M24LA

*** Follow the derating curve

TS78M05LA Electrical Characteristics

($V_{in}=10V$, $I_{out}=350mA$, $0^{\circ}C \leq T_j \leq 125^{\circ}C$, $C_{in}=0.33\mu F$, $C_{out}=0.1\mu F$; unless otherwise specified.)

Parameter	Symbol	Test Condition	Min	Typ	Max	Unit	
Output voltage	Vout	$T_j=25^{\circ}C$	4.90	5	5.10	V	
		$7.5V \leq V_{in} \leq 20V$, $5mA \leq I_{out} \leq 350mA$	4.80	5	5.20		
Line Regulation	REGline	$T_j=25^{\circ}C$	$7.5V \leq V_{in} \leq 25V$	--	3	100	mV
			$8V \leq V_{in} \leq 12V$	--	1	50	
Load Regulation	REGload	$T_j=25^{\circ}C$	$5mA \leq I_{out} \leq 500mA$	--	15	100	mV
			$5mA \leq I_{out} \leq 200mA$	--	5	50	
Quiescent Current	Iq	$I_{out}=0$, $T_j=25^{\circ}C$	--	3	6	mA	
Quiescent Current Change	ΔIq	$7.5V \leq V_{in} \leq 25V$	--	--	0.8		
		$5mA \leq I_{out} \leq 350mA$	--	--	0.5		
Output Noise Voltage	Vn	$10Hz \leq f \leq 100KHz$, $T_j=25^{\circ}C$	--	40	--	μV	
Ripple Rejection Ratio	RR	$f=120Hz$, $8V \leq V_{in} \leq 18V$	62	78	--	dB	
Voltage Drop	Vdrop	$I_{out}=500mA$, $T_j=25^{\circ}C$	--	2	--	V	
Output Resistance	Rout	$f=1KHz$	--	17	--	$m\Omega$	
Output Short Circuit Current	Ios	$T_j=25^{\circ}C$	--	50	--	mA	
Peak Output Current	I _{o peak}	$T_j=25^{\circ}C$	--	0.7	--	A	
Temperature Coefficient of Output Voltage	$\Delta V_{out} / \Delta T_j$	$I_{out}=5mA$, $0^{\circ}C \leq T_j \leq 125^{\circ}C$	--	-0.2	--	$mV / ^{\circ}C$	

TS78M06LA Electrical Characteristics

($V_{in}=11V$, $I_{out}=350mA$, $0^{\circ}C \leq T_j \leq 125^{\circ}C$, $C_{in}=0.33\mu F$, $C_{out}=0.1\mu F$; unless otherwise specified.)

Parameter	Symbol	Test Condition	Min	Typ	Max	Unit	
Output Voltage	Vout	$T_j=25^{\circ}C$	5.88	6	6.12	V	
		$8.5V \leq V_{in} \leq 21V$, $5mA \leq I_{out} \leq 350mA$	5.76	6	6.24		
Line Regulation	REGline	$T_j=25^{\circ}C$	$8.5V \leq V_{in} \leq 25V$	--	5	120	mV
			$9V \leq V_{in} \leq 13V$	--	1.5	60	
Load Regulation	REGload	$T_j=25^{\circ}C$	$5mA \leq I_{out} \leq 500mA$	--	14	120	mV
			$5mA \leq I_{out} \leq 200mA$	--	4	60	
Quiescent Current	Iq	$I_{out}=0$, $T_j=25^{\circ}C$	--	3	6	mA	
Quiescent Current Change	ΔIq	$8.5V \leq V_{in} \leq 25V$	--	--	0.8		
		$5mA \leq I_{out} \leq 350mA$	--	--	0.5		
Output Noise Voltage	Vn	$10Hz \leq f \leq 100KHz$, $T_j=25^{\circ}C$	--	45	--	μV	
Ripple Rejection Ratio	RR	$F=120Hz$, $9V \leq V_{in} \leq 19V$	59	80	--	dB	
Voltage Drop	Vdrop	$I_{out}=500mA$, $T_j=25^{\circ}C$	--	2	--	V	
Output Resistance	Rout	$F=1KHz$	--	19	--	$m\Omega$	
Output Short Circuit Current	Ios	$T_j=25^{\circ}C$	--	50	--	mA	
Peak Output Current	I _{o peak}	$T_j=25^{\circ}C$	--	0.7	--	A	
Temperature Coefficient of Output Voltage	$\Delta V_{out} / \Delta T_j$	$I_{out}=5mA$, $0^{\circ}C \leq T_j \leq 125^{\circ}C$	--	-0.2	--	$mV / ^{\circ}C$	

- Pulse testing techniques are used to maintain the junction temperature as close to the ambient temperature as possible, and thermal effects must be taken into account separately.
- This specification applies only for DC power dissipation permitted by absolute maximum ratings.

TS78M08LA Electrical Characteristics

$V_{in}=14V$, $I_{out}=350mA$, $0^{\circ}C \leq T_j \leq 125^{\circ}C$, $C_{in}=0.33\mu F$, $C_{out}=0.1\mu F$; unless otherwise specified.)

Parameter	Symbol	Test Condition	Min	Typ	Max	Unit	
Output voltage	Vout	Tj=25°C	7.84	8	8.16	V	
		10.5V ≤ Vin ≤ 23V, 5mA ≤ Iout ≤ 350mA	7.68	8	8.32		
Line Regulation	REGline	Tj=25°C	10.5V ≤ Vin ≤ 25V	--	6	160	mV
			11V ≤ Vin ≤ 17V	--	2	80	
Load Regulation	REGload	Tj=25°C	5mA ≤ Iout ≤ 500mA	--	12	160	
			5mA ≤ Iout ≤ 200mA	--	4	80	
Quiescent Current	Iq	Iout=0, Tj=25°C	--	3	6	mA	
Quiescent Current Change	ΔIq	10.5V ≤ Vin ≤ 25V 5mA ≤ Iout ≤ 350mA	--	--	0.8		
			--	--	0.5		
Output Noise Voltage	Vn	10Hz ≤ f ≤ 100KHz, Tj=25°C	--	52	--	μV	
Ripple Rejection Ratio	RR	f=120Hz, 11V ≤ Vin ≤ 21V	56	80	--	dB	
Voltage Drop	Vdrop	Iout=500mA, Tj=25°C	--	2	--	V	
Output Resistance	Rout	f=1KHz	--	16	--	mΩ	
Output Short Circuit Current	Ios	Tj=25°C	--	50	--	mA	
Peak Output Current	I _{o peak}	Tj=25°C	--	0.7	--	A	
Temperature Coefficient of Output Voltage	ΔVout/ ΔTj	Iout= 5mA, 0°C ≤ Tj ≤ 125°C	--	-0.2	--	mV/ °C	

TS78M09LA Electrical Characteristics

($V_{in}=15V$, $I_{out}=350mA$, $0^{\circ}C \leq T_j \leq 125^{\circ}C$, $C_{in}=0.33\mu F$, $C_{out}=0.1\mu F$; unless otherwise specified.)

Parameter	Symbol	Test Condition	Min	Typ	Max	Unit	
Output Voltage	Vout	Tj=25°C	8.82	9	9.18	V	
		11.5V ≤ Vin ≤ 23V, 5mA ≤ Iout ≤ 350mA	8.64	9	9.36		
Line Regulation	REGline	Tj=25°C	11.5V ≤ Vin ≤ 26V	--	6	180	mV
			12V ≤ Vin ≤ 17V	--	2	90	
Load Regulation	REGload	Tj=25°C	5mA ≤ Iout ≤ 500mA	--	12	180	
			5mA ≤ Iout ≤ 200mA	--	4	90	
Quiescent Current	Iq	Iout=0, Tj=25°C	--	3	6	mA	
Quiescent Current Change	ΔIq	11.5V ≤ Vin ≤ 26V 5mA ≤ Iout ≤ 350mA	--	--	0.8		
			--	--	0.5		
Output Noise Voltage	Vn	10Hz ≤ f ≤ 100KHz, Tj=25°C	--	52	--	uV	
Ripple Rejection Ratio	RR	f=120Hz, 12V ≤ Vin ≤ 22V	55	80	--	dB	
Voltage Drop	Vdrop	Iout=500mA, Tj=25°C	--	2	--	V	
Output Resistance	Rout	f=1KHz	--	16	--	mΩ	
Output Short Circuit Current	Ios	Tj=25°C	--	50	--	mA	
Peak Output Current	I _{o peak}	Tj=25°C	--	0.7	--	A	
Temperature Coefficient of Output Voltage	ΔVout/ ΔTj	Iout= 5mA, 0°C ≤ Tj ≤ 125°C	--	-0.2	--	mV/ °C	

- Pulse testing techniques are used to maintain the junction temperature as close to the ambient temperature as possible, and thermal effects must be taken into account separately.
- This specification applies only for DC power dissipation permitted by absolute maximum ratings.

TS78M12LA Electrical Characteristics

($V_{in}=19V$, $I_{out}=350mA$, $0^{\circ}C \leq T_j \leq 125^{\circ}C$, $C_{in}=0.33\mu F$, $C_{out}=0.1\mu F$; unless otherwise specified.)

Parameter	Symbol	Test Condition	Min	Typ	Max	Unit	
Output Voltage	Vout	$T_j=25^{\circ}C$	11.76	12	12.24	V	
		$14.5V \leq V_{in} \leq 27V$, $5mA \leq I_{out} \leq 350mA$	11.52	12	12.48		
Line Regulation	REGline	$T_j=25^{\circ}C$	$14.5V \leq V_{in} \leq 30V$	--	10	240	mV
			$15V \leq V_{in} \leq 19V$	--	3	120	
Load Regulation	REGload	$T_j=25^{\circ}C$	$5mA \leq I_{out} \leq 500mA$	--	12	240	
			$5mA \leq I_{out} \leq 200mA$	--	4	120	
Quiescent Current	Iq	$T_j=25^{\circ}C$, $I_{out}=0$	--	3	6	mA	
Quiescent Current Change	ΔIq	$14.5V \leq V_{in} \leq 30V$	--	--	0.8		
		$5mA \leq I_{out} \leq 500mA$	--	--	0.5		
Output Noise Voltage	Vn	$10Hz \leq f \leq 100KHz$, $T_j=25^{\circ}C$	--	75	--	μV	
Ripple Rejection Ratio	RR	$f=120Hz$, $15V \leq V_{in} \leq 25V$	55	80	--	dB	
Voltage Drop	Vdrop	$I_{out}=500mA$, $T_j=25^{\circ}C$	--	2	--	V	
Output Resistance	Rout	$f=1KHz$	--	18	--	$m\Omega$	
Output Short Circuit Current	Ios	$T_j=25^{\circ}C$	--	50	--	mA	
Peak Output Current	I _{o peak}	$T_j=25^{\circ}C$	--	0.7	--	A	
Temperature Coefficient of Output Voltage	$\Delta V_{out} / \Delta T_j$	$I_{out}=5mA$, $0^{\circ}C \leq T_j \leq 125^{\circ}C$	--	-0.3	--	$mV / ^{\circ}C$	

TS78M15LA Electrical Characteristics

($V_{in}=23V$, $I_{out}=350mA$, $0^{\circ}C \leq T_j \leq 125^{\circ}C$, $C_{in}=0.33\mu F$, $C_{out}=0.1\mu F$; unless otherwise specified.)

Parameter	Symbol	Test Condition	Min	Typ	Max	Unit	
Output voltage	Vout	$T_j=25^{\circ}C$	14.70	15	15.30	V	
		$17.5V \leq V_{in} \leq 30V$, $5mA \leq I_{out} \leq 350mA$	14.40	15	15.60		
Line Regulation	REGline	$T_j=25^{\circ}C$	$17.5V \leq V_{in} \leq 30V$	--	12	300	mV
			$18V \leq V_{in} \leq 22V$	--	3	150	
Load Regulation	REGload	$T_j=25^{\circ}C$	$5mA \leq I_{out} \leq 500mA$	--	12	300	
			$5mA \leq I_{out} \leq 200mA$	--	4	150	
Quiescent Current	Iq	$T_j=25^{\circ}C$, $I_{out}=0$	--	3	6	mA	
Quiescent Current Change	ΔIq	$17.5V \leq V_{in} \leq 30V$	--	--	0.8		
		$5mA \leq I_{out} \leq 500mA$	--	--	0.5		
Output Noise Voltage	Vn	$10Hz \leq f \leq 100KHz$, $T_j=25^{\circ}C$	--	90	--	μV	
Ripple Rejection Ratio	RR	$f=120Hz$, $18V \leq V_{in} \leq 28V$	54	80	--	dB	
Voltage Drop	Vdrop	$I_{out}=500mA$, $T_j=25^{\circ}C$	--	2	--	V	
Output Resistance	Rout	$f=1KHz$	--	19	--	$m\Omega$	
Output Short Circuit Current	Ios	$T_j=25^{\circ}C$	--	50	--	mA	
Peak Output Current	I _{o peak}	$T_j=25^{\circ}C$	--	0.7	--	A	
Temperature Coefficient of Output Voltage	$\Delta V_{out} / \Delta T_j$	$I_{out}=10mA$, $0^{\circ}C \leq T_j \leq 125^{\circ}C$	--	-0.3	--	$mV / ^{\circ}C$	

- Pulse testing techniques are used to maintain the junction temperature as close to the ambient temperature as possible, and thermal effects must be taken into account separately.
- This specification applies only for DC power dissipation permitted by absolute maximum ratings.

TS78M00LA Series

3-Terminal 500mA Positive Voltage Regulator

TS78M18LA Electrical Characteristics

($V_{in}=24V$, $I_{out}=350mA$, $0^{\circ}C \leq T_j \leq 125^{\circ}C$, $C_{in}=0.33\mu F$, $C_{out}=0.1\mu F$; unless otherwise specified.)

Parameter	Symbol	Test Condition	Min	Typ	Max	Unit	
Output Voltage	Vout	$T_j=25^{\circ}C$	17.64	18	18.36	V	
		$21V \leq V_{in} \leq 33V$, $5mA \leq I_{out} \leq 350mA$	17.28	18	18.72		
Line Regulation	REGline	$T_j=25^{\circ}C$	$21V \leq V_{in} \leq 33V$	--	15	360	mV
			$22V \leq V_{in} \leq 26V$	--	5	180	
Load Regulation	REGload	$T_j=25^{\circ}C$	$5mA \leq I_{out} \leq 500mA$	--	12	360	
			$5mA \leq I_{out} \leq 200mA$	--	4	180	
Quiescent Current	Iq	$T_j=25^{\circ}C$, $I_{out}=0$	--	3	6	mA	
Quiescent Current Change	ΔIq	$21V \leq V_{in} \leq 33V$	--	--	0.8		
		$5mA \leq I_{out} \leq 500mA$	--	--	0.5		
Output Noise Voltage	Vn	$10Hz \leq f \leq 100KHz$, $T_j=25^{\circ}C$	--	110	--	μV	
Ripple Rejection Ratio	RR	$f=120Hz$, $21V \leq V_{in} \leq 31V$	54	80	--	dB	
Voltage Drop	Vdrop	$I_{out}=500mA$, $T_j=25^{\circ}C$	--	2	--	V	
Output Resistance	Rout	$f=1KHz$	--	22	--	$m\Omega$	
Output Short Circuit Current	Ios	$T_j=25^{\circ}C$	--	50	--	mA	
Peak Output Current	I _{o peak}	$T_j=25^{\circ}C$	--	0.7	--	A	
Temperature Coefficient of Output Voltage	$\Delta V_{out} / \Delta T_j$	$I_{out}=5mA$, $0^{\circ}C \leq T_j \leq 125^{\circ}C$	--	-0.5	--	$mV / ^{\circ}C$	

TS78M24LA Electrical Characteristics

($V_{in}=33V$, $I_{out}=350mA$, $0^{\circ}C \leq T_j \leq 125^{\circ}C$, $C_{in}=0.33\mu F$, $C_{out}=0.1\mu F$; unless otherwise specified.)

Parameter	Symbol	Test Condition	Min	Typ	Max	Unit	
Output voltage	Vout	$T_j=25^{\circ}C$	23.52	24	24.48	V	
		$27V \leq V_{in} \leq 38V$, $5mA \leq I_{out} \leq 350mA$	23.07	24	25.96		
Line Regulation	REGline	$T_j=25^{\circ}C$	$27V \leq V_{in} \leq 38V$	--	18	480	mV
			$28V \leq V_{in} \leq 32V$	--	6	240	
Load Regulation	REGload	$T_j=25^{\circ}C$	$5mA \leq I_{out} \leq 500mA$	--	12	480	
			$5mA \leq I_{out} \leq 200mA$	--	4	240	
Quiescent Current	Iq	$I_{out}=0$, $T_j=25^{\circ}C$	--	3	6	mA	
Quiescent Current Change	ΔIq	$27V \leq V_{in} \leq 38V$	--	--	0.8		
		$5mA \leq I_{out} \leq 500mA$	--	--	0.5		
Output Noise Voltage	Vn	$10Hz \leq f \leq 100KHz$, $T_j=25^{\circ}C$	--	170	--	μV	
Ripple Rejection Ratio	RR	$f=120Hz$, $27V \leq V_{in} \leq 37V$	54	80	--	dB	
Voltage Drop	Vdrop	$I_{out}=500mA$, $T_j=25^{\circ}C$	--	2	--	V	
Output Resistance	Rout	$f=1KHz$	--	28	--	$m\Omega$	
Output Short Circuit Current	Ios	$T_j=25^{\circ}C$	--	50	--	mA	
Peak Output Current	I _{o peak}	$T_j=25^{\circ}C$	--	0.7	--	A	
Temperature Coefficient of Output Voltage	$\Delta V_{out} / \Delta T_j$	$I_{out}=5mA$, $0^{\circ}C \leq T_j \leq 125^{\circ}C$	--	-0.5	--	$mV / ^{\circ}C$	

- Pulse testing techniques are used to maintain the junction temperature as close to the ambient temperature as possible, and thermal effects must be taken into account separately.
- This specification applies only for DC power dissipation permitted by absolute maximum ratings.

Electrical Characteristics Curve

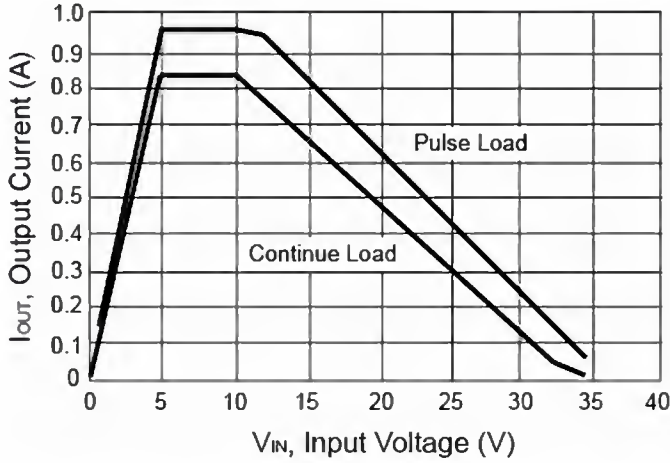

Figure 1. Input Voltage vs. Output Current (max.)

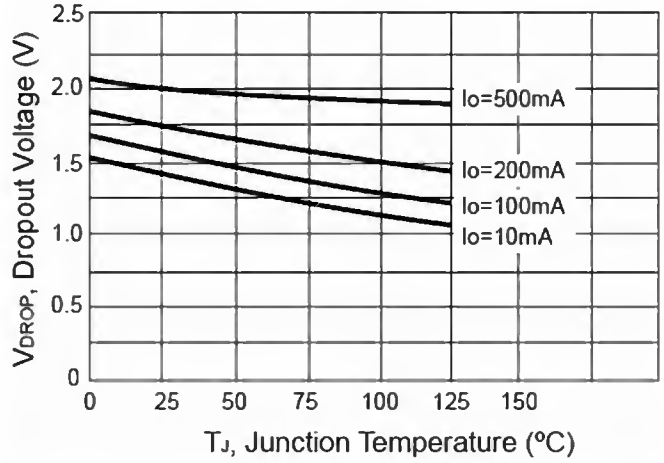

Figure 2. V_{drop} vs. Junction Temperature

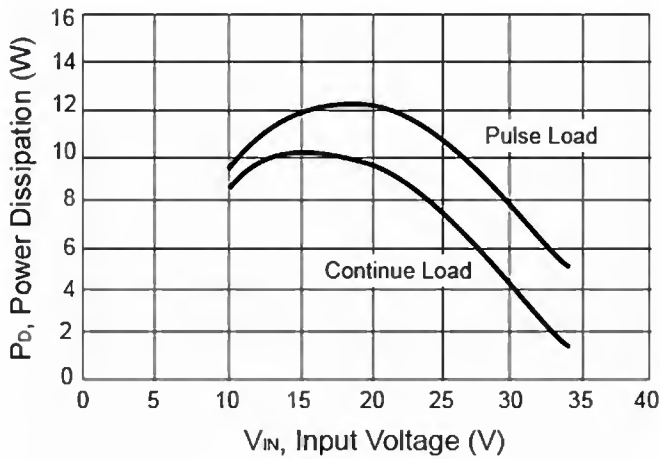

Figure 3. Input Voltage vs. Power Dissipation

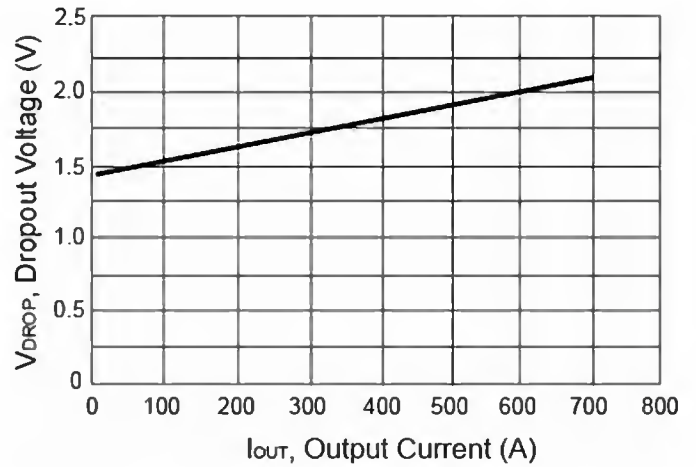

Figure 4. V_{drop} vs. Output Current

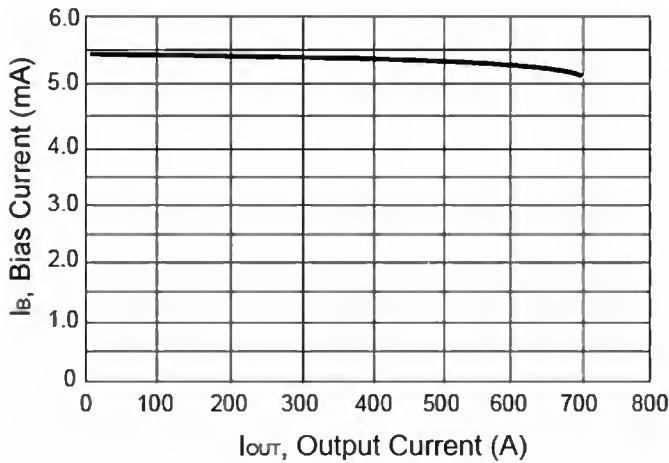

Figure 5. Bias Current vs. Output Current

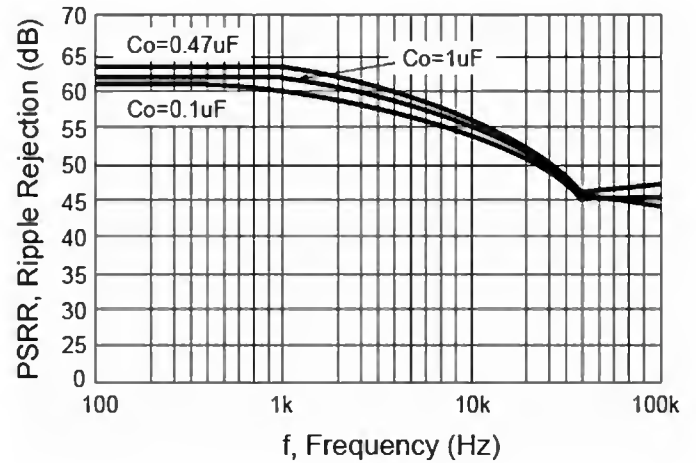

Figure 6. Ripple Rejection vs. Frequency

Application information

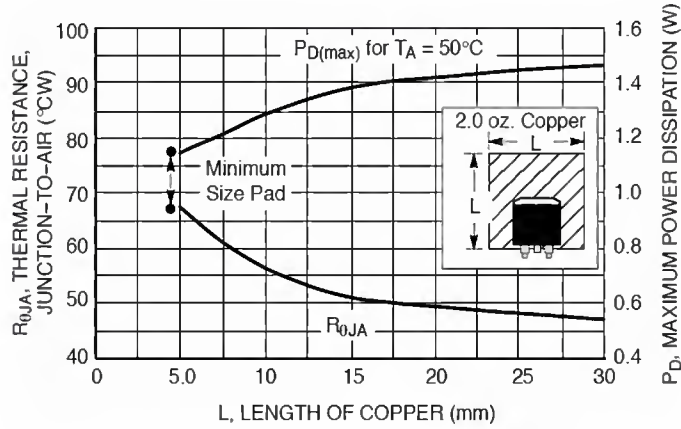
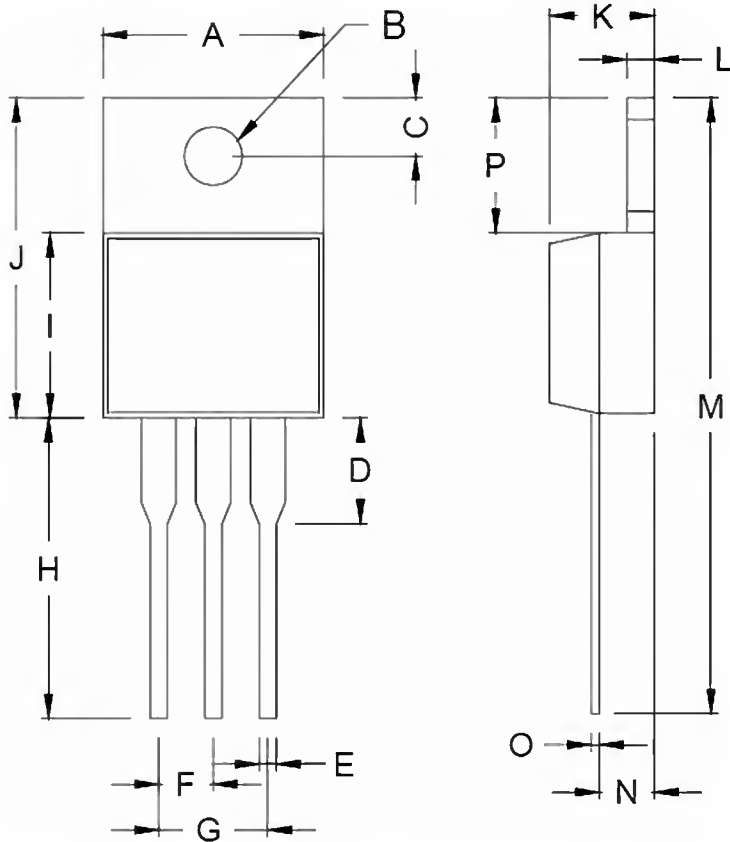

Figure 7. DPAK Thermal Resistance and Maximum Power Dissipation vs. P.C.B Copper Length

TO-220 Mechanical Drawing



TO-220 DIMENSION				
DIM	MILLIMETERS		INCHES	
	MIN	MAX	MIN	MAX
A	9.31	10.550	0.366	0.415
B	3.740	3.910	0.147	0.154
C	2.440	2.940	0.096	0.116
D	2.22	3.22	0.087	0.127
E	0.78	0.98	0.030	0.038
F	2.34	2.65	0.092	0.104
G	4.69	5.31	0.184	0.209
H	12.32	13.88	0.485	0.546
I	8.74	9.26	0.344	0.364
J	15.07	16.07	0.593	0.632
K	4.35	4.65	0.171	0.183
L	1.16	1.40	0.045	0.055
M	27.39	30.35	1.078	1.194
N	1.785	2.675	0.070	0.105
O	1.50	1.75	0.059	0.068
P	5.75	7.65	0.226	0.301

Marking Diagram

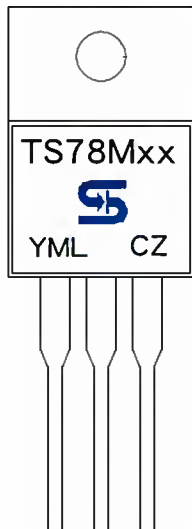

- XX** = Output Voltage
(05=5V, 08=8V, 09=9V, 12=12V, 15=15V, 18=18V, 24=24V)
- Y** = Year Code
- M** = Month Code
(A=Jan, B=Feb, C=Mar, D=Apl, E=May, F=Jun, G=Jul, H=Aug, I=Sep, J=Oct, K=Nov, L=Dec)
- L** = Lot Code
- CZ** = Package Code for TO-220

TO-252 Mechanical Drawing

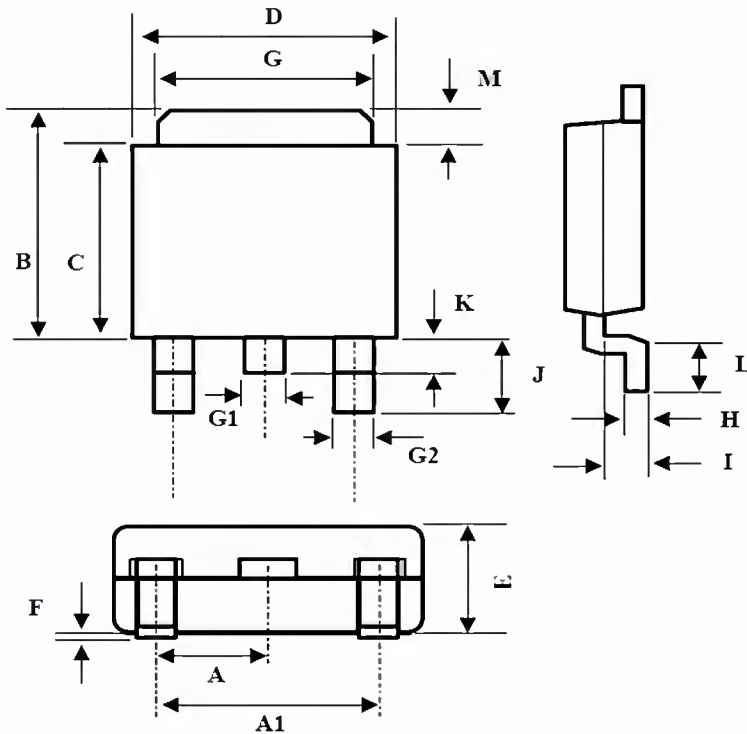

TO-252 DIMENSION				
DIM	MILLIMETERS		INCHES	
	MIN	MAX	MIN	MAX
A	2.3BSC		0.09BSC	
A1	4.6BSC		0.18BSC	
B	6.80	7.20	0.268	0.283
C	5.40	5.60	0.213	0.220
D	6.40	6.65	0.252	0.262
E	2.20	2.40	0.087	0.094
F	0.00	0.20	0.000	0.008
G	5.20	5.40	0.205	0.213
G1	0.75	0.85	0.030	0.033
G2	0.55	0.65	0.022	0.026
H	0.35	0.65	0.014	0.026
I	0.90	1.50	0.035	0.059
J	2.20	2.80	0.087	0.110
K	0.50	1.10	0.020	0.043
L	0.90	1.50	0.035	0.059
M	1.30	1.70	0.051	0.67

Marking Diagram

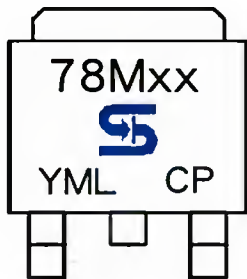

- XX** = Output Voltage
(05=5V, 08=8V, 09=9V, 12=12V, 15=15V, 18=18V, 24=24V)
- Y** = Year Code
- M** = Month Code
(A=Jan, B=Feb, C=Mar, D=Apr, E=May, F=Jun, G=Jul, H=Aug, I=Sep, J=Oct, K=Nov, L=Dec)
- L** = Lot Code
- CP** = Package Code for TO-252

TS78M00LA Series

3-Terminal 500mA Positive Voltage Regulator

Notice

Specifications of the products displayed herein are subject to change without notice. TSC or anyone on its behalf, assumes no responsibility or liability for any errors or inaccuracies.

Information contained herein is intended to provide a product description only. No license, express or implied, to any intellectual property rights is granted by this document. Except as provided in TSC's terms and conditions of sale for such products, TSC assumes no liability whatsoever, and disclaims any express or implied warranty, relating to sale and/or use of TSC products including liability or warranties relating to fitness for a particular purpose, merchantability, or infringement of any patent, copyright, or other intellectual property right.

The products shown herein are not designed for use in medical, life-saving, or life-sustaining applications. Customers using or selling these products for use in such applications do so at their own risk and agree to fully indemnify TSC for any damages resulting from such improper use or sale.