

# BCW70LT1G

## General Purpose Transistor

### PNP Silicon

#### Features

- These Devices are Pb-Free, Halogen Free/BFR Free and are RoHS Compliant

#### MAXIMUM RATINGS

Rating	Symbol	Value	Unit
Collector-Emitter Voltage	$V_{CEO}$	-45	Vdc
Emitter-Base Voltage	$V_{EBO}$	-5.0	Vdc
Collector Current - Continuous	$I_C$	-100	mAdc

#### THERMAL CHARACTERISTICS

Characteristic	Symbol	Max	Unit
Total Device Dissipation FR-5 Board (Note 1) $T_A = 25^\circ\text{C}$ Derate above $25^\circ\text{C}$	$P_D$	225 1.8	mW mW/ $^\circ\text{C}$
Thermal Resistance, Junction-to-Ambient	$R_{\theta JA}$	556	$^\circ\text{C}/\text{W}$
Total Device Dissipation Alumina Substrate, (Note 2) @ $T_A = 25^\circ\text{C}$ Derate above $25^\circ\text{C}$	$P_D$	300 2.4	mW mW/ $^\circ\text{C}$
Thermal Resistance, Junction-to-Ambient	$R_{\theta JA}$	417	$^\circ\text{C}/\text{W}$
Junction and Storage Temperature	$T_J, T_{stg}$	-55 to +150	$^\circ\text{C}$

Stresses exceeding Maximum Ratings may damage the device. Maximum Ratings are stress ratings only. Functional operation above the Recommended Operating Conditions is not implied. Extended exposure to stresses above the Recommended Operating Conditions may affect device reliability.

1. FR-5 = 1.0 x 0.75 x 0.062 in.
2. Alumina = 0.4 x 0.3 x 0.024 in. 99.5% alumina



ON Semiconductor®

<http://onsemi.com>

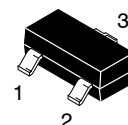
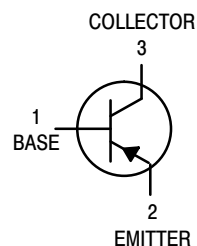

SOT-23 (TO-236AB)  
CASE 318  
STYLE 6

#### MARKING DIAGRAM

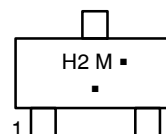

H2 = Device Code  
M = Date Code\*  
▪ = Pb-Free Package

(Note: Microdot may be in either location)

\*Date Code orientation and/or overbar may vary depending upon manufacturing location.

#### ORDERING INFORMATION

Device	Package	Shipping†
BCW70LT1G	SOT-23 (Pb-Free)	3000 / Tape & Reel

†For information on tape and reel specifications, including part orientation and tape sizes, please refer to our Tape and Reel Packaging Specifications Brochure, BRD8011/D.

# BCW70LT1G

## ELECTRICAL CHARACTERISTICS (T<sub>A</sub> = 25°C unless otherwise noted)

Characteristic	Symbol	Min	Max	Unit
<b>OFF CHARACTERISTICS</b>				
Collector–Emitter Breakdown Voltage (I <sub>C</sub> = –2.0 mA <sub>dc</sub> , I <sub>B</sub> = 0)	V <sub>(BR)CEO</sub>	–45	–	V <sub>dc</sub>
Collector–Emitter Breakdown Voltage (I <sub>C</sub> = –100 μA <sub>dc</sub> , V <sub>EB</sub> = 0)	V <sub>(BR)CES</sub>	–50	–	V <sub>dc</sub>
Emitter–Base Breakdown Voltage (I <sub>E</sub> = –10 μA <sub>dc</sub> , I <sub>C</sub> = 0)	V <sub>(BR)EBO</sub>	–5.0	–	V <sub>dc</sub>
Collector Cutoff Current (V <sub>CB</sub> = –20 V <sub>dc</sub> , I <sub>E</sub> = 0) (V <sub>CB</sub> = –20 V <sub>dc</sub> , I <sub>E</sub> = 0, T <sub>A</sub> = 100°C)	I <sub>CBO</sub>	–	–100 –10	nA <sub>dc</sub> μA <sub>dc</sub>
<b>ON CHARACTERISTICS</b>				
DC Current Gain (I <sub>C</sub> = –2.0 mA <sub>dc</sub> , V <sub>CE</sub> = –5.0 V <sub>dc</sub> )	h <sub>FE</sub>	215	500	–
Collector–Emitter Saturation Voltage (I <sub>C</sub> = –10 mA <sub>dc</sub> , I <sub>B</sub> = –0.5 mA <sub>dc</sub> )	V <sub>CE(sat)</sub>	–	–0.3	V <sub>dc</sub>
Base–Emitter On Voltage (I <sub>C</sub> = –2.0 mA <sub>dc</sub> , V <sub>CE</sub> = –5.0 V <sub>dc</sub> )	V <sub>BE(on)</sub>	–0.6	–0.75	V <sub>dc</sub>
<b>SMALL–SIGNAL CHARACTERISTICS</b>				
Output Capacitance (I <sub>E</sub> = 0, V <sub>CB</sub> = –10 V <sub>dc</sub> , f = 1.0 MHz)	C <sub>obo</sub>	–	7.0	pF
Noise Figure (I <sub>C</sub> = –0.2 mA <sub>dc</sub> , V <sub>CE</sub> = –5.0 V <sub>dc</sub> , R <sub>S</sub> = 2.0 kΩ, f = 1.0 kHz, BW = 200 Hz)	N <sub>F</sub>	–	10	dB

# BCW70LT1G

## TYPICAL NOISE CHARACTERISTICS

( $V_{CE} = -5.0$  Vdc,  $T_A = 25^\circ\text{C}$ )

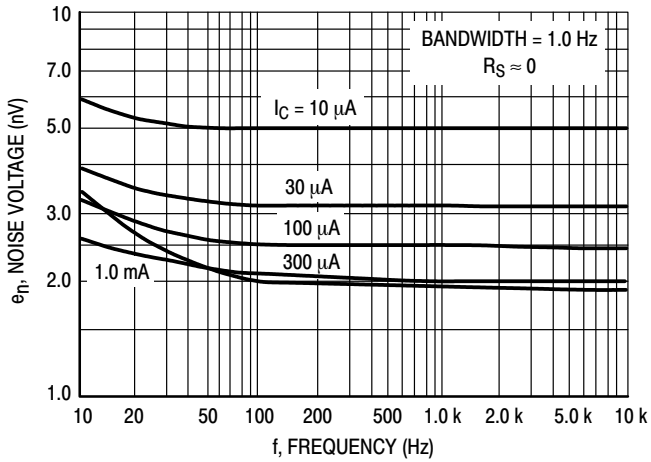

Figure 1. Noise Voltage

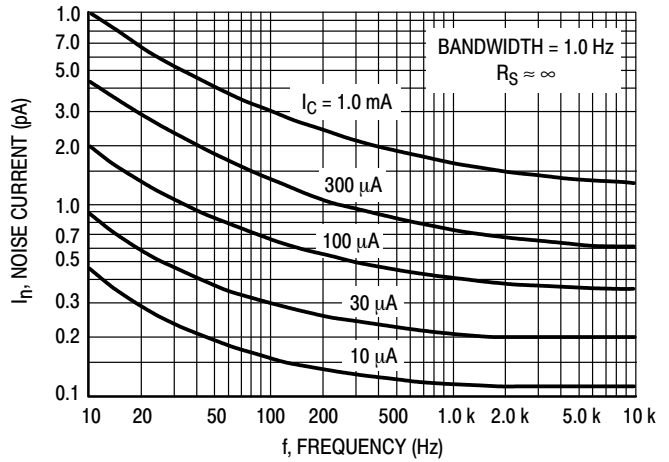

Figure 2. Noise Current

## NOISE FIGURE CONTOURS

( $V_{CE} = -5.0$  Vdc,  $T_A = 25^\circ\text{C}$ )

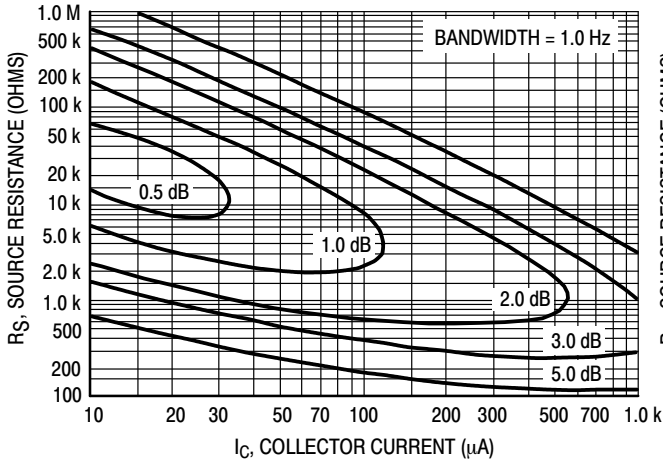

Figure 3. Narrow Band, 100 Hz

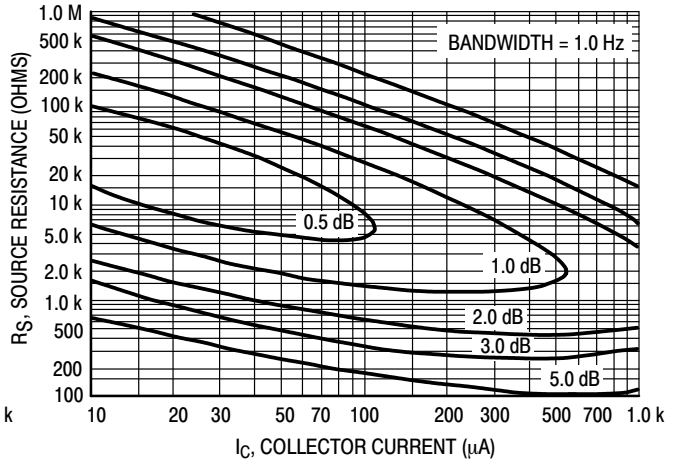

Figure 4. Narrow Band, 1.0 kHz

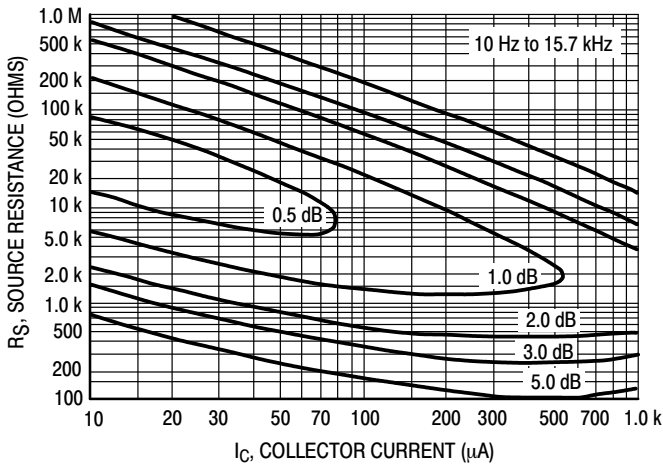

Figure 5. Wideband

Noise Figure is Defined as:

$$NF = 20 \log_{10} \left[ \frac{e_n^2 + 4KTR_S + I_n^2 R_S^2}{4KTR_S} \right]^{1/2}$$

$e_n$  = Noise Voltage of the Transistor referred to the input. (Figure 3)

$I_n$  = Noise Current of the Transistor referred to the input.

(Figure 4)

$K$  = Boltzman's Constant ( $1.38 \times 10^{-23}$  j/°K)

$T$  = Temperature of the Source Resistance (°K)

$R$  = Source Resistance (Ohms)

$S$

# BCW70LT1G

## TYPICAL STATIC CHARACTERISTICS

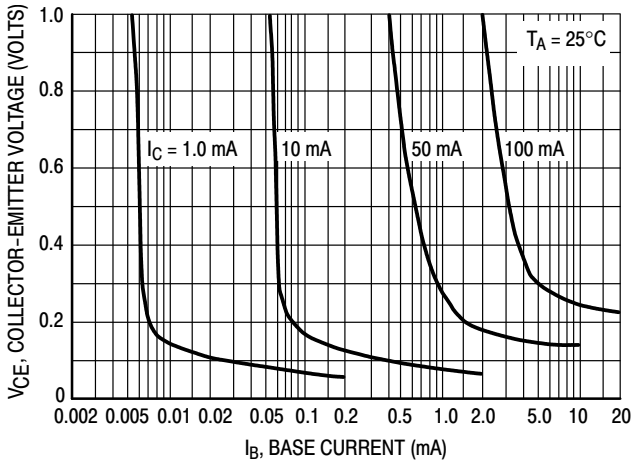

Figure 6. Collector Saturation Region

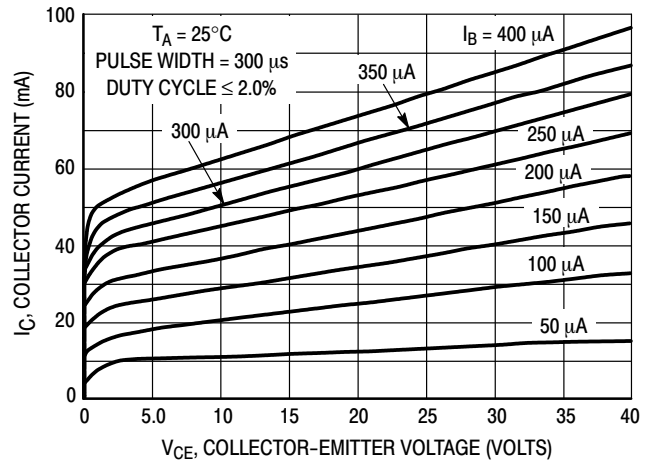

Figure 7. Collector Characteristics

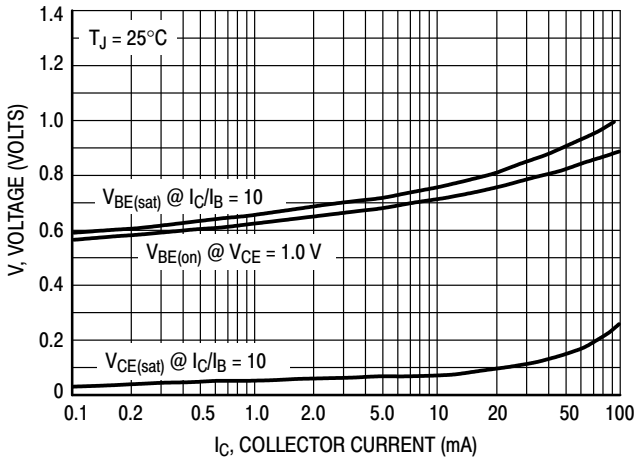

Figure 8. "On" Voltages

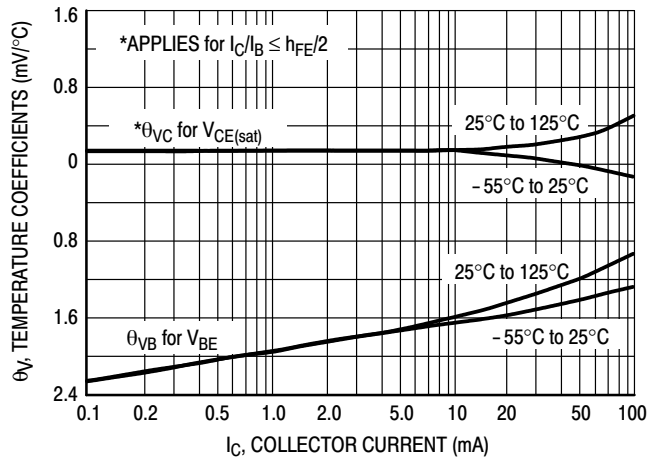

Figure 9. Temperature Coefficients

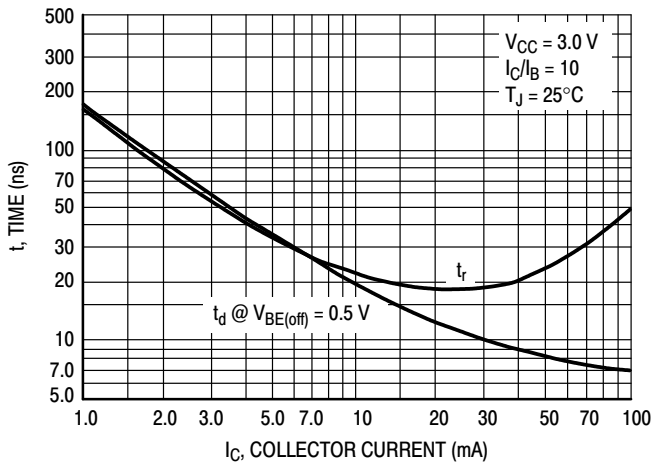

Figure 10. Turn-On Time

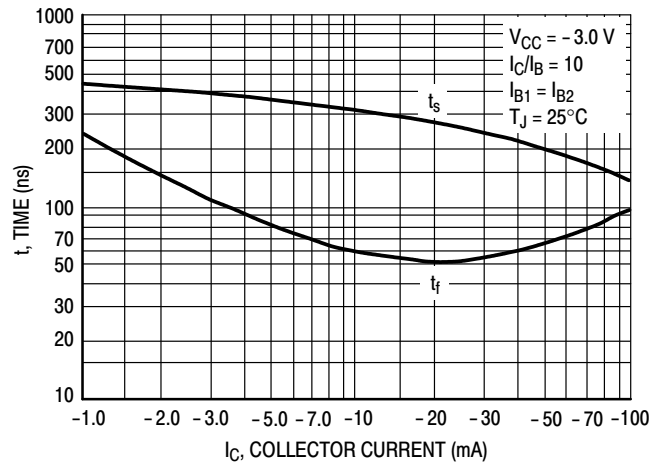

Figure 11. Turn-Off Time

# BCW70LT1G

## TYPICAL DYNAMIC CHARACTERISTICS

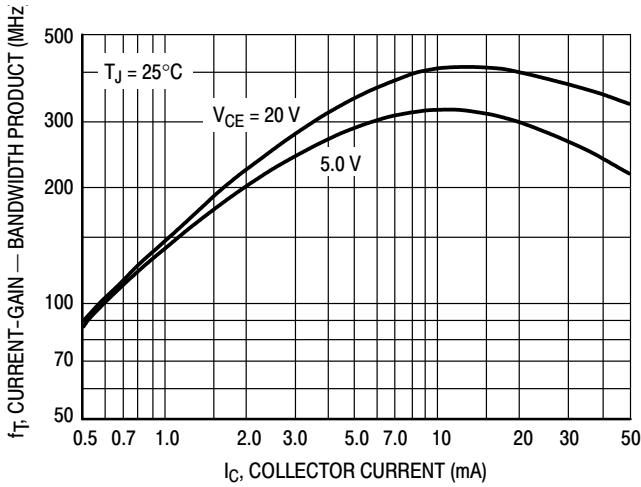

Figure 12. Current-Gain — Bandwidth Product

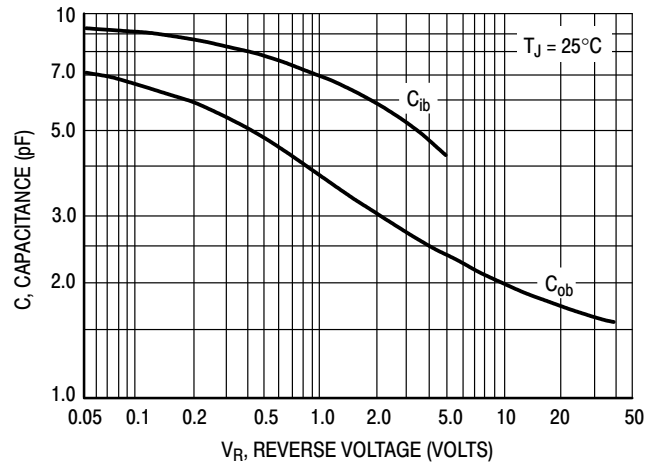

Figure 13. Capacitance

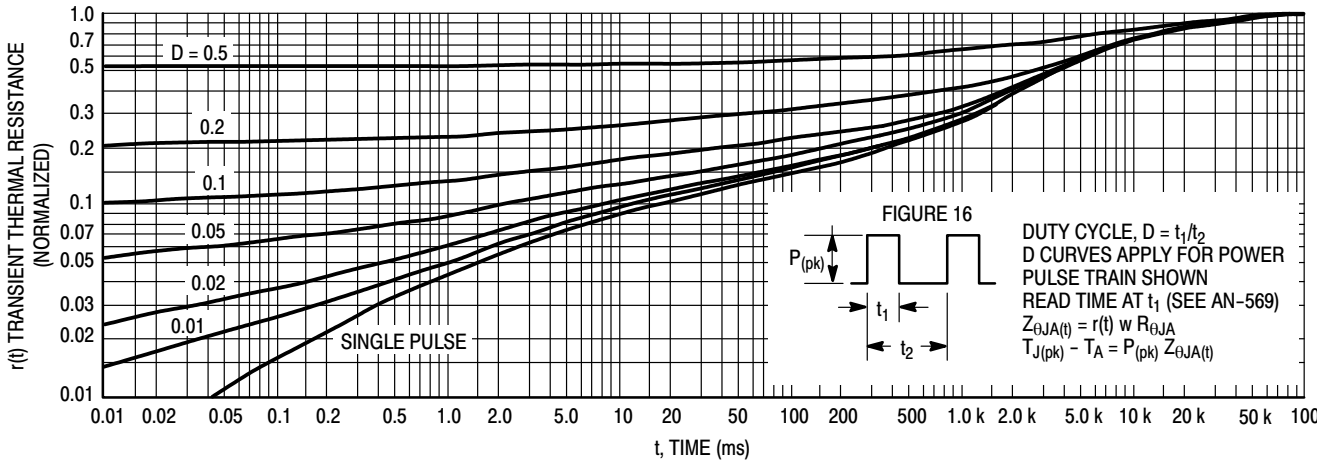

Figure 14. Thermal Response

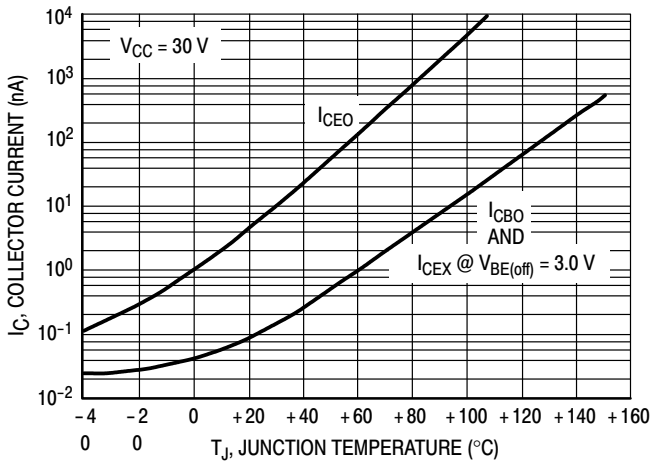

Figure 15. Typical Collector Leakage Current

### DESIGN NOTE: USE OF THERMAL RESPONSE DATA

A train of periodical power pulses can be represented by the model as shown in Figure 16. Using the model and the device thermal response the normalized effective transient thermal resistance of Figure 14 was calculated for various duty cycles.

To find  $Z_{\theta JA}(t)$ , multiply the value obtained from Figure 14 by the steady state value  $R_{\theta JA}$ .

Example:

Dissipating 2.0 watts peak under the following conditions:

$$t_1 = 1.0 \text{ ms}, t_2 = 5.0 \text{ ms} (D = 0.2)$$

Using Figure 14 at a pulse width of 1.0 ms and  $D = 0.2$ , the reading of  $r(t)$  is 0.22.

The peak rise in junction temperature is therefore

$$\Delta T = r(t) \times P_{(pk)} \times R_{\theta JA} = 0.22 \times 2.0 \times 200 = 88^\circ\text{C}.$$

For more information, see AN-569.

# BCW70LT1G

## PACKAGE DIMENSIONS

SOT-23 (TO-236)  
CASE 318-08  
ISSUE AN

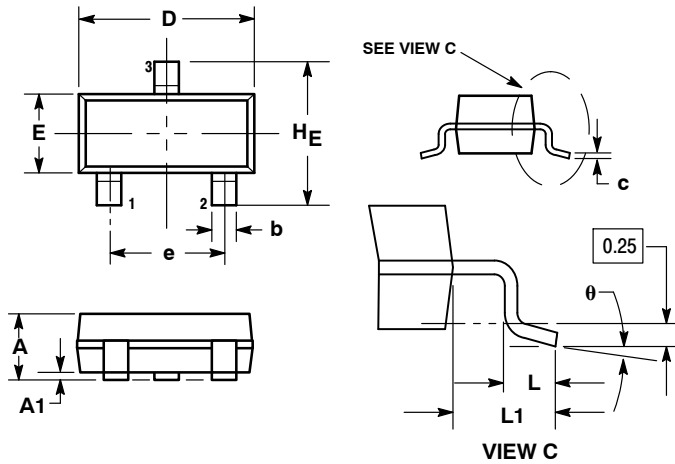

NOTES:

1. DIMENSIONING AND TOLERANCING PER ANSI Y14.5M, 1982.
2. CONTROLLING DIMENSION: INCH.
3. MAXIMUM LEAD THICKNESS INCLUDES LEAD FINISH THICKNESS. MINIMUM LEAD THICKNESS IS THE MINIMUM THICKNESS OF BASE MATERIAL.
4. 318-01 THRU -07 AND -09 OBSOLETE, NEW STANDARD 318-08.

DIM	MILLIMETERS			INCHES		
	MIN	NOM	MAX	MIN	NOM	MAX
A	0.89	1.00	1.11	0.035	0.040	0.044
A1	0.01	0.06	0.10	0.001	0.002	0.004
b	0.37	0.44	0.50	0.015	0.018	0.020
c	0.09	0.13	0.18	0.003	0.005	0.007
D	2.80	2.90	3.04	0.110	0.114	0.120
E	1.20	1.30	1.40	0.047	0.051	0.055
e	1.78	1.90	2.04	0.070	0.075	0.081
L	0.10	0.20	0.30	0.004	0.008	0.012
L1	0.35	0.54	0.69	0.014	0.021	0.029
HE	2.10	2.40	2.64	0.083	0.094	0.104

STYLE 6:

1. BASE
2. EMITTER
3. COLLECTOR

### SOLDERING FOOTPRINT\*

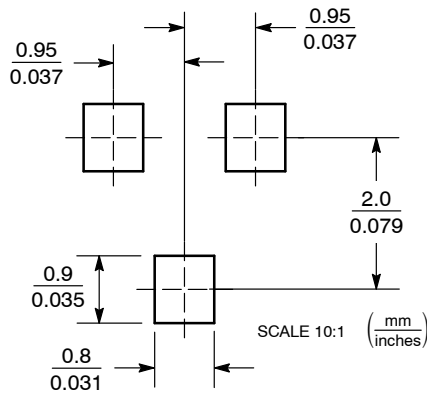

\*For additional information on our Pb-Free strategy and soldering details, please download the ON Semiconductor Soldering and Mounting Techniques Reference Manual, SOLDERRM/D.

ON Semiconductor and are registered trademarks of Semiconductor Components Industries, LLC (SCILLC). SCILLC reserves the right to make changes without further notice to any products herein. SCILLC makes no warranty, representation or guarantee regarding the suitability of its products for any particular purpose, nor does SCILLC assume any liability arising out of the application or use of any product or circuit, and specifically disclaims any and all liability, including without limitation special, consequential or incidental damages. "Typical" parameters which may be provided in SCILLC data sheets and/or specifications can and do vary in different applications and actual performance may vary over time. All operating parameters, including "Typicals" must be validated for each customer application by customer's technical experts. SCILLC does not convey any license under its patent rights nor the rights of others. SCILLC products are not designed, intended, or authorized for use as components in systems intended for surgical implant into the body, or other applications intended to support or sustain life, or for any other application in which the failure of the SCILLC product could create a situation where personal injury or death may occur. Should Buyer purchase or use SCILLC products for any such unintended or unauthorized application, Buyer shall indemnify and hold SCILLC and its officers, employees, subsidiaries, affiliates, and distributors harmless against all claims, costs, damages, and expenses, and reasonable attorney fees arising out of, directly or indirectly, any claim of personal injury or death associated with such unintended or unauthorized use, even if such claim alleges that SCILLC was negligent regarding the design or manufacture of the part. SCILLC is an Equal Opportunity/Affirmative Action Employer. This literature is subject to all applicable copyright laws and is not for resale in any manner.

### PUBLICATION ORDERING INFORMATION

**LITERATURE FULFILLMENT:**  
Literature Distribution Center for ON Semiconductor  
P.O. Box 5163, Denver, Colorado 80217 USA  
**Phone:** 303-675-2175 or 800-344-3860 Toll Free USA/Canada  
**Fax:** 303-675-2176 or 800-344-3867 Toll Free USA/Canada  
**Email:** orderlit@onsemi.com

**N. American Technical Support:** 800-282-9855 Toll Free  
USA/Canada  
**Europe, Middle East and Africa Technical Support:**  
Phone: 421 33 790 2910  
**Japan Customer Focus Center**  
Phone: 81-3-5773-3850

**ON Semiconductor Website:** [www.onsemi.com](http://www.onsemi.com)  
**Order Literature:** <http://www.onsemi.com/orderlit>  
For additional information, please contact your local Sales Representative