



ELECTRONICS

www.DataSheet4U.com

Approval

Product Information

ISSUE DATE : 2007-08-07

MODEL : LMS350GF08

**Note : The Product and specifications are subject to change without any notice.
Please ask for the latest Product Standards to guarantee the satisfaction of
your product requirements.**

PREPARED BY : LCD Mobile Display Development

LCD DIVISION

Samsung Electronics Co., Ltd.



Revision History

Date	Rev. No.	Page	Summary
Aug.07. 2007	000		Rev.000 was issued.

Contents

General Description	----- (5)
1. Absolute Maximum Ratings	----- (6)
1.1 Absolute Ratings Of Environment	
1.2 Electrical Absolute Ratings	
2. Optical Characteristics	----- (8)
3. Electrical Characteristics	----- (12)
3.1 TFT-LCD Module	
3.2 Back-light Unit	
4. Touch Screen Panel Specification	----- (14)
4.1 Electrical Characteristics	
4.2 Mechanical & Reliability Characteristics	
4.3 Integration Design Guide	
5. Block Diagram	----- (17)
5.1 TFT-LCD Module(Interface System Structure) with Back Light Unit	
5.2 Touch Screen Panel	
5.3 Back-light Unit	
6. Input Terminal Pin Assignment	----- (19)
6.1 Input Signal & Power	
6.2 Back-Light Unit	
6.3 Touch screen panel	
6.4 Input Signal, Basic Display colors and Gray Scale of Each Colors	
7. Operation Specifications	----- (22)
7.1 Serial Peripheral Interface	
7.2 Data Format for 24bit RGB Interface	
7.3 24bit RGB Interface Timing	
7.4 Electrical Specifications	
8. Power On/Off Sequence	----- (26)
8.1 Power On Sequence	
8.2 Display On Sequence	
8.3 Display Off Sequence	
8.4 Power Off Sequence	
8.5 Stand-by Sequence	
9. ResetB	----- (32)
10. Reliability Test Result	----- (33)
11. Outline Dimension	----- (35)
12. Application Circuit	----- (36)

Approval

13. Packing

----- (37)

14. Marking & Others

----- (38)

15. General Precaution

----- (39)

15.1 Handling

15.2 Storage

15.3 Operation

15.4 Others

General Description

www.DataSheet4U.com

* Description

LMS350GF08-001 is a TMR(Transmissive with Micro Reflective) type color active matrix TFT (Thin Film Transistor) liquid crystal display (LCD) that uses amorphous silicon TFT as a switching devices. This model is composed of a TFT-LCD module, a driver circuit and a back-light unit and a touch screen panel(TSP).

The resolution of a 3.5" contains 320xRGBx240 dots and can display up to 16.7M colors.

* Features

- Transmissive with Micro Reflective type and back-light with six LEDs are available.
- Using the Touch Screen Panel(Film to Film-Glass type).
- TN(Twisted Nematic) mode.
- Line inversion mode with stripe type.
- 24bit RGB Interface + Serial Peripheral Interface(SPI)
- De mode(Enable, Vsync, Hsync, Dotclk), SYNC(Vsync, Hsync, Dotclk) mode
- Gate Driver IC embeded on Panel(Double ASG)

* Applications

- Display terminals for P-CNS, PMP, Photo Printer, Voip-phone application products.

* General information

Items	Specification	Unit	Note
Display area	70.08(H) x 52.56(V)	mm	-
Driver element	a-Si TFT active matrix	-	-
Display colors	16.7M	colors	-
Number of pixels	320xRGB(H) x 240(V)	dot	-
Pixel arrangement	stripe type	-	-
Pixel pitch	0.219(H) x 0.219(V)	mm	-
Display mode	Normally White	-	-
Viewing direction	6	o'clock	-

* Mechanical information

Item		Min.	Typ.	Max.	Unit	Note
Module size	Horizontal(H)	76.70	76.90	77.10	mm	-
	Vertical(V)	63.70	63.90	64.10	mm	(1)
	Depth(D)	4.05	4.25	4.45	mm	(1)
Weight		-	42	46	g	-

Note (1) Not include FPC.

Refer to the Outline Dimension in the "10.Outline Dimension" for further information.

(2) Touch Screen Panel and Back-light unit are included.

1. Absolute Maximum Ratings

www.DataSheet4U.com

1.1 Environment

ITEM	MIN	MAX	REMARK
Storage Temperature	-30	70	Note(1)
Operating Temperature	-20	70	Note(2)(3)

Note(1) 90%RH maximum humidity, 60 maximum wet-bulb temperature

(2) When operated at a temperature lower than 0 ,
the LCD worked slowly and the screen appeared low-contrast images
due to the characteristics of LC(Liquid Crystal).

(3) If any fixed pattern is displayed on LCD for minutes,
image-sticking phenomenon may occur.

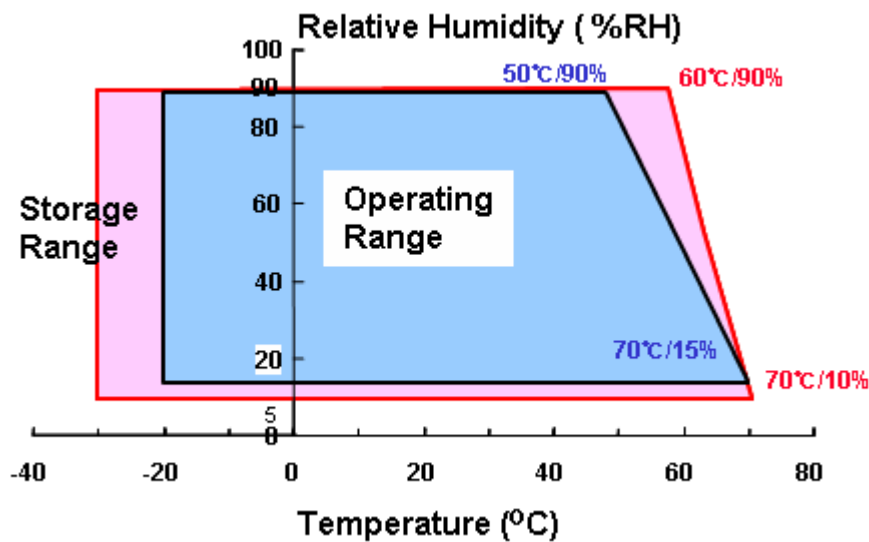

Temperature & Humidity Graph at Absolute Environment

1.2 Electrical Absolute Ratings

(1) TFT-LCD Module

(Ta = 25 ± 2°C, V_{ss}=GND=0)

Characteristics	Symbol	Min.	Max.	Unit	Note
Analog supply voltage	VCI	-0.3	7.0	V	-
Digital supply voltage	VDD	-0.3	5.0	V	-

(2) Back-Light Unit

(Ta = 25 ± 2°C)

Item	Symbol	Min.	Max.	Unit.	Note
Current	I _B		25	mA	(1)

Note (1) Permanent damage to the device may occur if maximum values are exceeded or reverse voltage is loaded.

Functional operation should be restricted to the conditions described under normal operating conditions.

2. Optical Characteristics

www.DataSheet4U.com

The following items are measured under stable conditions. The optical characteristics should be measured in a dark room or equivalent state with the methods shown in Note (1).

Measuring equipment: BM-7, SR-3, EZ-Contrast

fg

(Ta = 25 ± 2°C, VCI = 3.3V, VDD = 1.8V, IB = 20mA)

Item	Symbol	Condition	Min.	Typ.	Max.	Unit	Note	
Contrast ratio (Center point)	C/R		100	300	-	-	(2) SR-3	
Luminance of white (Center point)	YL	NOTE (1)	240	320	-	cd/m ²	(3) SR-3	
Response time	Rising:Tr	Tr+Tf	-	25	-	msec	(4) BM-7	
	Falling:Tf							
Color chromaticity (CIE 1931)	White	Wx	Normal Viewing Angle	0.261	0.311	0.361	-	(5) SR-3
		Wy		0.284	0.334	0.384		
	Red	Rx	0.561	0.611	0.661			
		Ry	0.305	0.355	0.405			
	Green	Gx	B/L On	0.296	0.346	0.396		
		Gy		0.503	0.553	0.603		
	Blue	Bx	0.096	0.146	0.196			
		By	0.078	0.128	0.178			
Viewing angle	Hor.	qL	C/R ³ 10	55	65	Degrees	(6) Ez-Contrast	
		qR		55	65			
	Ver.	fH	B/L On	40	50			
		fL		45	55			

Note (1) Test Equipment Setup

www.DataSheet4U.com

After stabilizing and leaving the panel alone at a given temperature for 30 min , the measurement should be executed. Measurement should be executed in a stable, windless, and dark room. 30 min after lighting the back-light. This should be measured in the center of screen.

Environment condition : $T_a = 25 \pm 2 \text{ }^\circ\text{C}$

Back-Light On condition

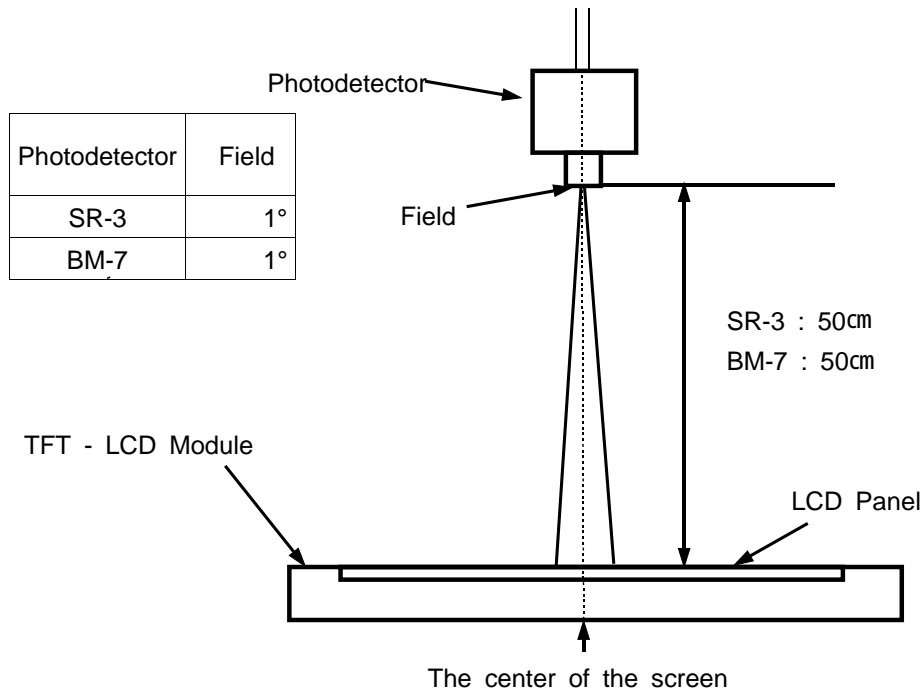

Note (2) Definition of Contrast Ratio (C/R) : Ratio of gray max (Gmax) & gray min (Gmin) at the center point

$$CR = \frac{G \text{ max}}{G \text{ min}}$$

* Gmax : Luminance with all pixels white

* Gmin : Luminance with all pixels black

Note (3) Definition of Luminance of White : Luminance of white at the center point

Note (4) Definition of Response time : Sum of T_r , T_f

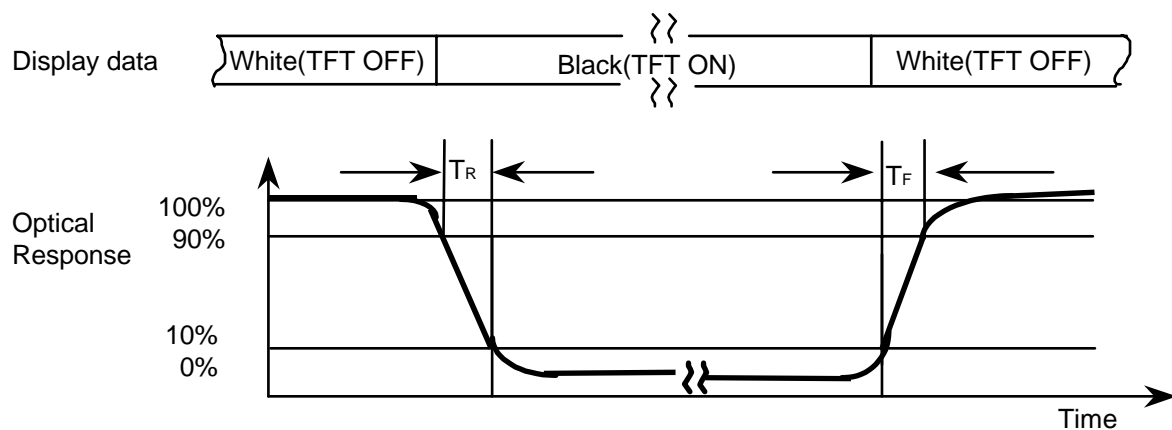

Note (5) Definition of Color Chromaticity (CIE 1931)

Color coordinate of white & red, green, blue at center point.

www.DataSheet4U.com
Note (6) Definition of Viewing Angle : Viewing angle range (CR 10)

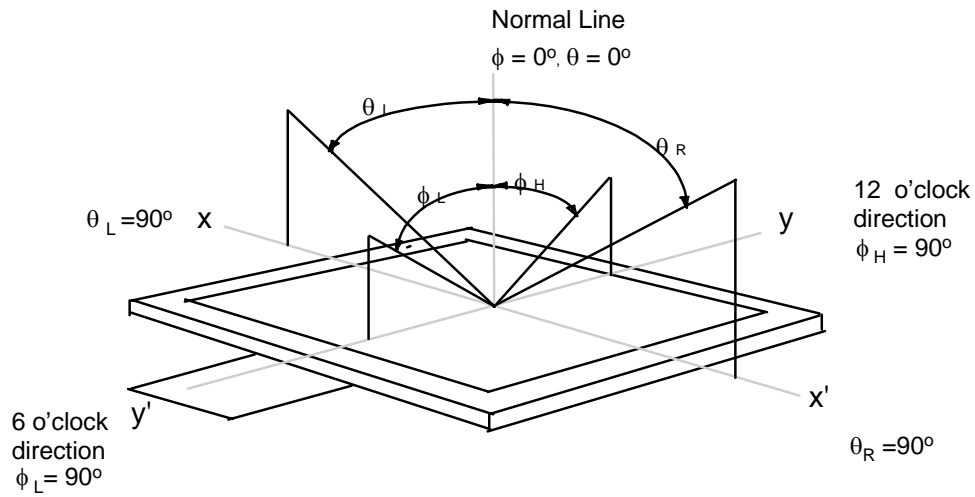

3. Electrical Characteristics

www.DataSheet4U.com

3.1 TFT-LCD Module

$T_a = 25 \pm 2^\circ\text{C}$

Characteristics		Symbol	Min.	Typ.	Max.	Unit	Note
Power supply voltage		VCI	3.0	3.3	3.5	V	-
IO Power supply voltage		VDD	1.8	3.3	3.5	V	-
Power Dissipation	Black	P_{FULL}	-	55	66	mW	-
	White	P	-	50	60		
Current Dissipation	Black	I_{FULL}	-	17	20	mA	
	White	I	-	15	18		
Frame frequency		f_{Frame}	-	60 (75)	-	Hz	-
Dot Clock		DCK	-	5.5 (6.8)	27	MHz	-
Serial Clock		XSCK			28	MHz	

To prevent a latch-up or DC operation of the LCD module, the power on/off sequence should be as the Chapter 8. Power On/Off Sequence.

- Note**
- (1) VDD = 3.3V, VCI = 3.3V $f_{Frame} = 60$ Hz, DOTCLK = 5.5 MHz
 - (2) Dissipation current check pattern

0 Gray black pattern

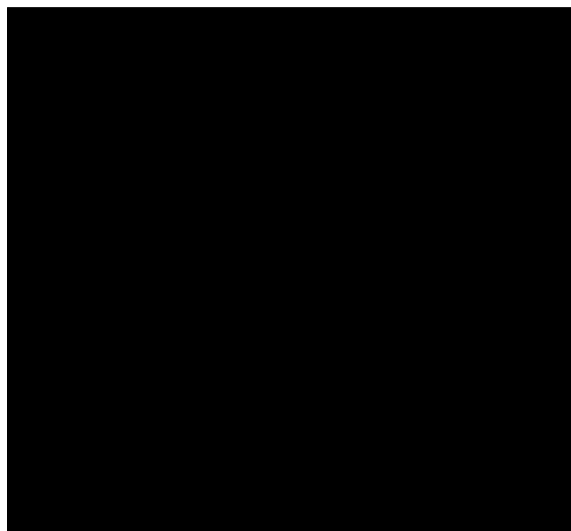

3.2 Back-Light unit

www.DataSheet4U.com

The back-light system is an edge-lighting type with **six** white LED(Light Emitting Diode)s.

(Ta=25 ± 2°C)

Item	Symbol	Min.	Typ.	Max.	Unit	Note
Current	I _B	-	20	-	mA	(1)
Power Consumption	P _{BL}	-	(400)	-	mW	(2)

Note (1) **Six** LEDs serial type.

(2) Where $I_B = 20\text{mA}$, $V_B = P_{BL} / I_B$

■ Ambient Temperature vs. Allowable Forward Current

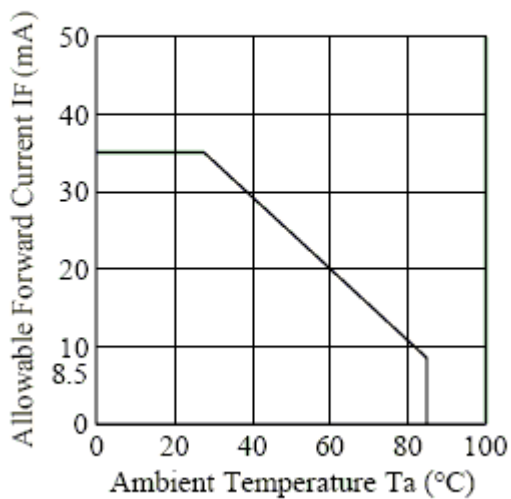

4. Touch Screen Panel Specifications

www.DataSheet4U.com

4-1. Electrical Characteristics

Item	Min.	Typ.	Max.	Unit	Note
Linearity	-1.5	-	1.5	%	Analog X and Y directions
Terminal resistance	200	460	900	Ω	X(Film side)
	200	350	900	Ω	Y(Film side)
Insulation resistance	25	-	-	M Ω	DC 25V
Voltage	-	-	7	V	DC
Chattering	-	-	10	ms	100k pull-up
Transparency	78	80	-	%	Non-glare

Caution (1) : Do not operate it with a thing except a polyacetal pen(tip R0.8mm or less) or a finger, especially those with hard or sharp tips such as a ball point pen or a mechanical pencil.

4-2. Mechanical & Reliability Characteristics

Item	Min.	Typ.	Max.	Unit	Note
Activation force	5		80	g	(1)
Durability-surface scratching	Write 100,000	-	-	characters	(2)
Durability-surface pitting	1,000,000	-	-	touches	(3)
Surface hardness	3	-	-	H	JIS K5400, ASTM D3363

Note (1) Stylus pen Input : R0.8mm polyacetal pen or Finger

(2) Measurement for Surface area

- Scratch 100,000 times straight line on the Film with a stylus change every 20,000times
- Force : 250gf
- Speed : 60mm/sec
- Stylus : R0.8 polyacetal tip

(3) Pit 1,000,000 times on the Film with a R8.0 silicon rubber.

- Force : 250gf
- Speed : 2times/sec

4-3. Integration Design Guide

- Avoid the design that Front-case overlap and press on the active area of the touch-panel.
- Give enough gap (over 0.5mm at compressed) between the front case and touch-panel to protect wrong operating.

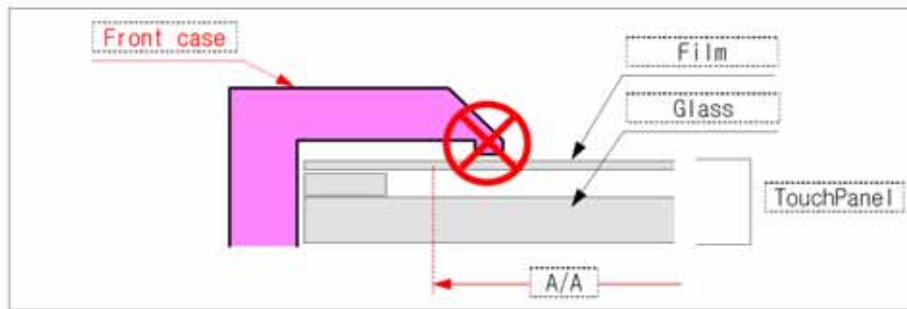

- Use a buffer material(Gasket) between the touch-panel and Front-case to protect damage and wrong operating.
- Avoid the design that buffer material overlap and press on the inside of touch-panel viewing area.

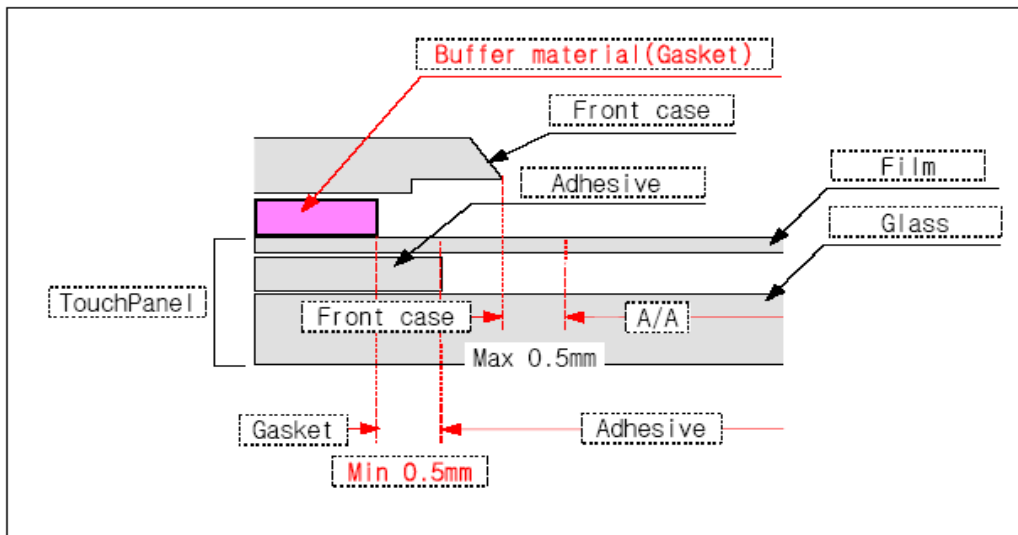

Approval

www.DataSheet4U.com

www.DataSheet4U.com

Doc . No	LMS350GF08	Rev.No	000	Page	16/40
----------	------------	--------	-----	------	-------

5. Block Diagram

www.DataSheet4U.com

5.1 TFT-LCD Module (Interface System Structure) with Back Light Unit

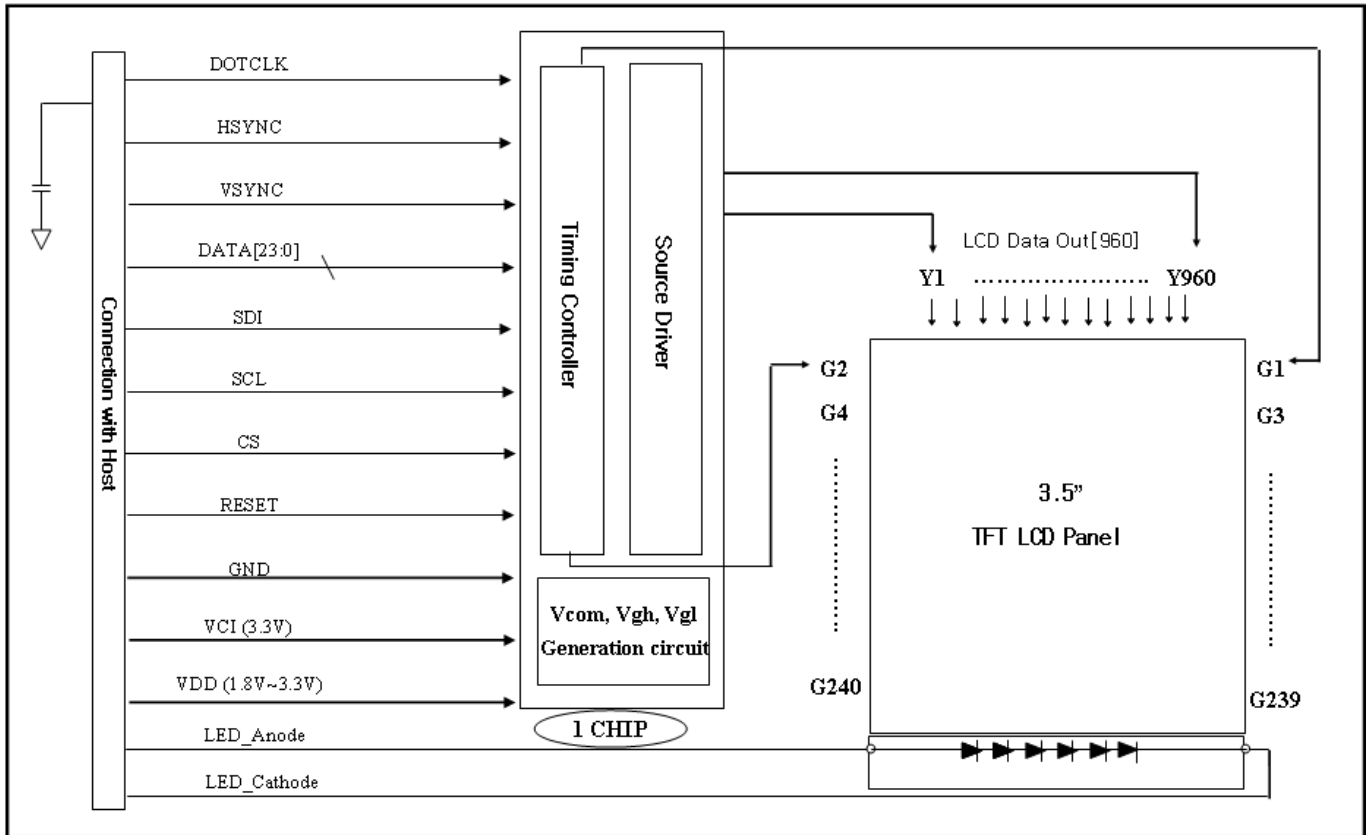

5.2 Touch Screen Panel

www.DataSheet4U.com

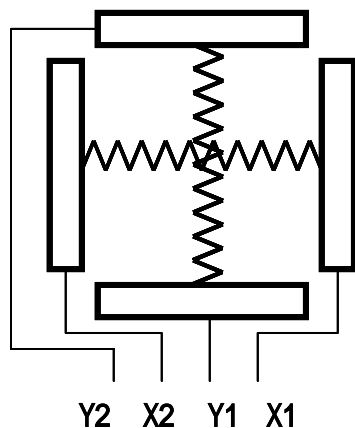

Top View

X : Lower electrode
Y : Upper electrode

5.3 Back-light Unit

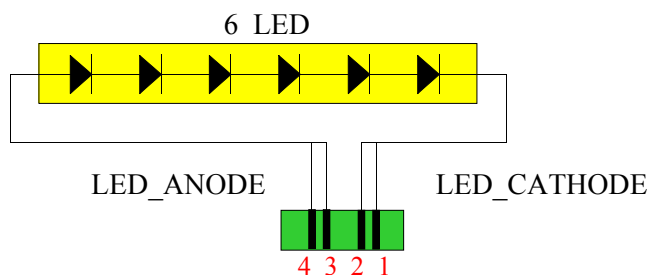

Pin No.	Symbol	I/O
1,2	LED_CATHODE	Cathode
3,4	LED_ANODE	Anode

6. Input Terminal Pin Assignment

www.DataSheet4U.com

6.1 Input Signal & Power (Connector type : 71Pin / 0.3mm pitch / Bottom contact)

- HIROSE : FH26-71S-0.3SHW

No	Symbol	Description	I/O	No	Symbol	Description	I/O
1,2	LED-	LED__Cathode	I	26	VC11	Stable Capacitor connection	O
3,4	LED+	LED__Anode	I	27,28	VCI	Main Power	I
5	GND	Ground	I	29	C23M	Stable Capacitor connection	O
6	X1	X_Right	I	30	C23P		
7	Y1	Y_Bottom	I	31	VCL	Stable Capacitor connection	O
8	X2	X_Left	I	32	VSSA	Ground	I
9	Y2	Y_Up	I	33	VCOMH	Stable Capacitor connection	O
10	GND	Ground	I	34	VCOML	Stable Capacitor connection	O
11	VGOFFL	Stable Capacitor connection	O	35	GVDD	Stable Capacitor connection	O
12	GND	Ground	I	36	RVDD	Stable Capacitor connection	O
13	VGL	Stable Capacitor connection	O	37	GND	Ground	I
14	GND	Ground	I	38,39	VDD	I/O Power	I
15	VGH	Stable Capacitor connection	O	40	VSYN	Vertical Synchronous Signal	I
16	C22P	Stable Capacitor connection	O	41	HSYN	Horizontal Synchronous Signal	I
17	C22M			42	DOTCLK	Data clock	I
18	C22P	Stable Capacitor connection	O	43	ENABLE	Data Enable (*NOTE)	I
19	C22M			44~51	DATA23~16	Red data(MSB ~ LSB)	I
20	AVDD	Stable Capacitor connection	O	52~59	DATA 15~8	Green data(MSB ~ LSB)	I
21	C11Pb	Stable Capacitor connection	O	60~67	DATA 7~0	Blue data(MSB ~ LSB)	I
22	C11Pb			68	SCL	Serial Clock	I
23	C11P	Stable Capacitor connection	O	69	CSB	Chip Select	I
24	C11M			70	SDI	Serial Data	I
25	VSSC	Ground	I	71	RESETB	Reset	I

* NOTE. Selects the RGB Interface mode.

(1) Connect Enable pin at GND in SYNC without Enable(DE) mode.

(2) Connect Enable pin at Enable in SYNC with Enable(DE) mode.

6.2 Back-Light Unit (Connector : 4 Pin FPC Solder type)

Pin No.	Symbol	Function
1,2	LED_CATHODE	LED Cathode
3,4	LED_ANODE	LED Anode

6.3 Touch Screen Panel (Connector : 4 Pin FPC Solder type)

Pin No.	Symbol	I/O	Function
6	X1	Right	Right electrode - differential analog
7	Y1	Bottom	Bottom electrode - differential analog
8	X2	Left	Left electrode - differential analog
9	Y2	Top	Top electrode - differential analog

6.4 Input Signal, Basic Display Colors and Gray Scale of Each Colors

COLOR	DISPLAY	DATA SIGNAL																												GRAY SCALE LEVEL
		RED							GREEN							BLUE														
		R0	R1	R2	R3	R4	R5	R6	R7	G0	G1	G2	G3	G4	G5	G6	G7	B0	B1	B2	B3	B4	B5	B6	B7					
BASIC COLOR	BLACK	0	0	0	0	0	0	0	0	0	0	0	0	0	0	0	0	0	0	0	0	0	0	0	0	0	0	0	-	
	BLUE	0	0	0	0	0	0	0	0	0	0	0	0	0	0	0	0	1	1	1	1	1	1	1	1	1	1	1	-	
	GREEN	0	0	0	0	0	0	0	0	1	1	1	1	1	1	1	1	0	0	0	0	0	0	0	0	0	0	0	-	
	CYAN	0	0	0	0	0	0	0	0	1	1	1	1	1	1	1	1	1	1	1	1	1	1	1	1	1	1	1	-	
	RED	1	1	1	1	1	1	1	1	0	0	0	0	0	0	0	0	0	0	0	0	0	0	0	0	0	0	0	-	
	MAGENTA	1	1	1	1	1	1	1	1	0	0	0	0	0	0	0	0	1	1	1	1	1	1	1	1	1	1	1	-	
	YELLOW	1	1	1	1	1	1	1	1	1	1	1	1	1	1	1	1	0	0	0	0	0	0	0	0	0	0	0	-	
	WHITE	1	1	1	1	1	1	1	1	1	1	1	1	1	1	1	1	1	1	1	1	1	1	1	1	1	1	1	-	
GRAY SCALE OF RED	BLACK	0	0	0	0	0	0	0	0	0	0	0	0	0	0	0	0	0	0	0	0	0	0	0	0	0	0	R0		
	DARK	1	0	0	0	0	0	0	0	0	0	0	0	0	0	0	0	0	0	0	0	0	0	0	0	0	0	R1		
		0	1	0	0	0	0	0	0	0	0	0	0	0	0	0	0	0	0	0	0	0	0	0	0	0	0	R2		
		:	:	:	:	:	:	:	:	:	:	:	:	:	:	:	:	:	:	:	:	:	:	:	:	:	:	R3~R252		
		:	:	:	:	:	:	:	:	:	:	:	:	:	:	:	:	:	:	:	:	:	:	:	:	:	:			
	LIGHT	1	0	1	1	1	1	1	1	0	0	0	0	0	0	0	0	0	0	0	0	0	0	0	0	0	0	R253		
		0	1	1	1	1	1	1	1	0	0	0	0	0	0	0	0	0	0	0	0	0	0	0	0	0	0	R254		
	RED	1	1	1	1	1	1	1	1	0	0	0	0	0	0	0	0	0	0	0	0	0	0	0	0	0	0	R255		
GRAY SCALE OF GREEN	BLACK	0	0	0	0	0	0	0	0	0	0	0	0	0	0	0	0	0	0	0	0	0	0	0	0	0	0	G0		
	DARK	0	0	0	0	0	0	0	0	1	0	0	0	0	0	0	0	0	0	0	0	0	0	0	0	0	0	G1		
		0	0	0	0	0	0	0	0	0	1	0	0	0	0	0	0	0	0	0	0	0	0	0	0	0	0	G2		
		:	:	:	:	:	:	:	:	:	:	:	:	:	:	:	:	:	:	:	:	:	:	:	:	:	:	G3~G252		
		:	:	:	:	:	:	:	:	:	:	:	:	:	:	:	:	:	:	:	:	:	:	:	:	:	:			
	LIGHT	0	0	0	0	0	0	0	0	1	0	1	1	1	1	1	1	0	0	0	0	0	0	0	0	0	0	G253		
		0	0	0	0	0	0	0	0	0	1	1	1	1	1	1	1	0	0	0	0	0	0	0	0	0	0	G254		
	GREEN	0	0	0	0	0	0	0	0	1	1	1	1	1	1	1	1	0	0	0	0	0	0	0	0	0	0	G255		
GRAY SCALE OF BLUE	BLACK	0	0	0	0	0	0	0	0	0	0	0	0	0	0	0	0	0	0	0	0	0	0	0	0	0	0	B0		
	DARK	0	0	0	0	0	0	0	0	0	0	0	0	0	0	0	0	1	0	0	0	0	0	0	0	0	0	B1		
		0	0	0	0	0	0	0	0	0	0	0	0	0	0	0	0	0	1	0	0	0	0	0	0	0	0	B2		
		:	:	:	:	:	:	:	:	:	:	:	:	:	:	:	:	:	:	:	:	:	:	:	:	:	:	B3~B252		
		:	:	:	:	:	:	:	:	:	:	:	:	:	:	:	:	:	:	:	:	:	:	:	:	:	:			
	LIGHT	0	0	0	0	0	0	0	0	0	0	0	0	0	0	0	0	1	0	1	1	1	1	1	1	1	1	B253		
		0	0	0	0	0	0	0	0	0	0	0	0	0	0	0	0	0	1	1	1	1	1	1	1	1	1	B254		
	BLUE	0	0	0	0	0	0	0	0	0	0	0	0	0	0	0	0	1	1	1	1	1	1	1	1	1	1	B255		

Note) Definition of Gray :

Rn : Red Gray, Gn : Green Gray, Bn : Blue Gray (n = Gray level)

Input Signal : 0 = Low level voltage, 1 = High level voltage

7. Operation Specifications

www.DataSheet4U.com

7.1 Serial Peripheral Interface

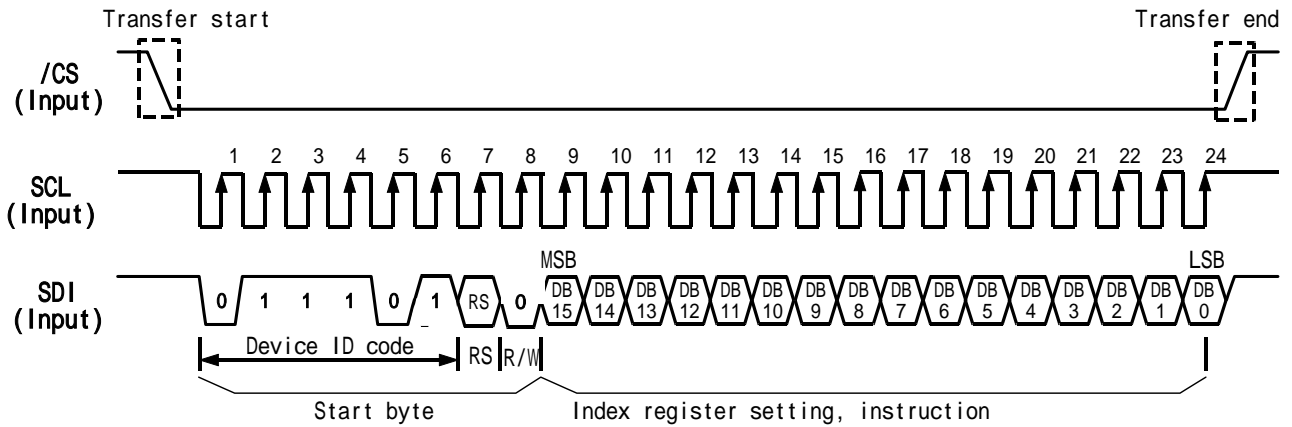

(Note) RS="0": Index data
RS="1": Instruction data

7.2 Data Format for 24bit RGB Interface

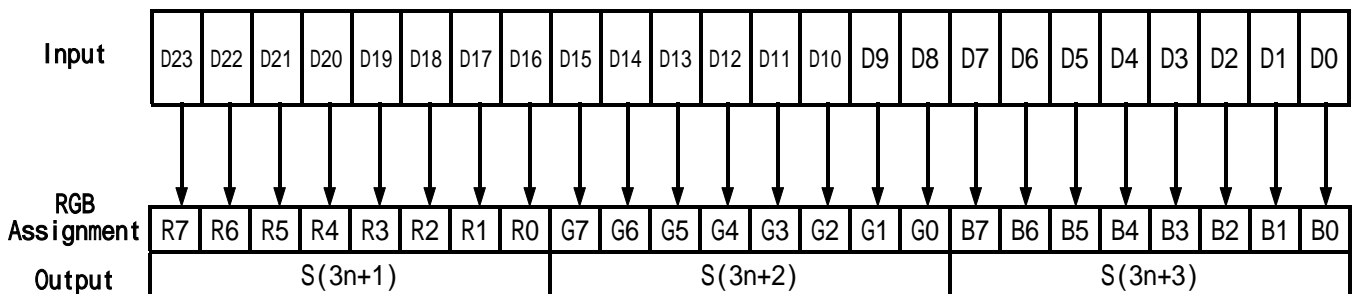

7.3 24bit RGB Interface Timing

www.DataSheet4U.com
- SYNC mode

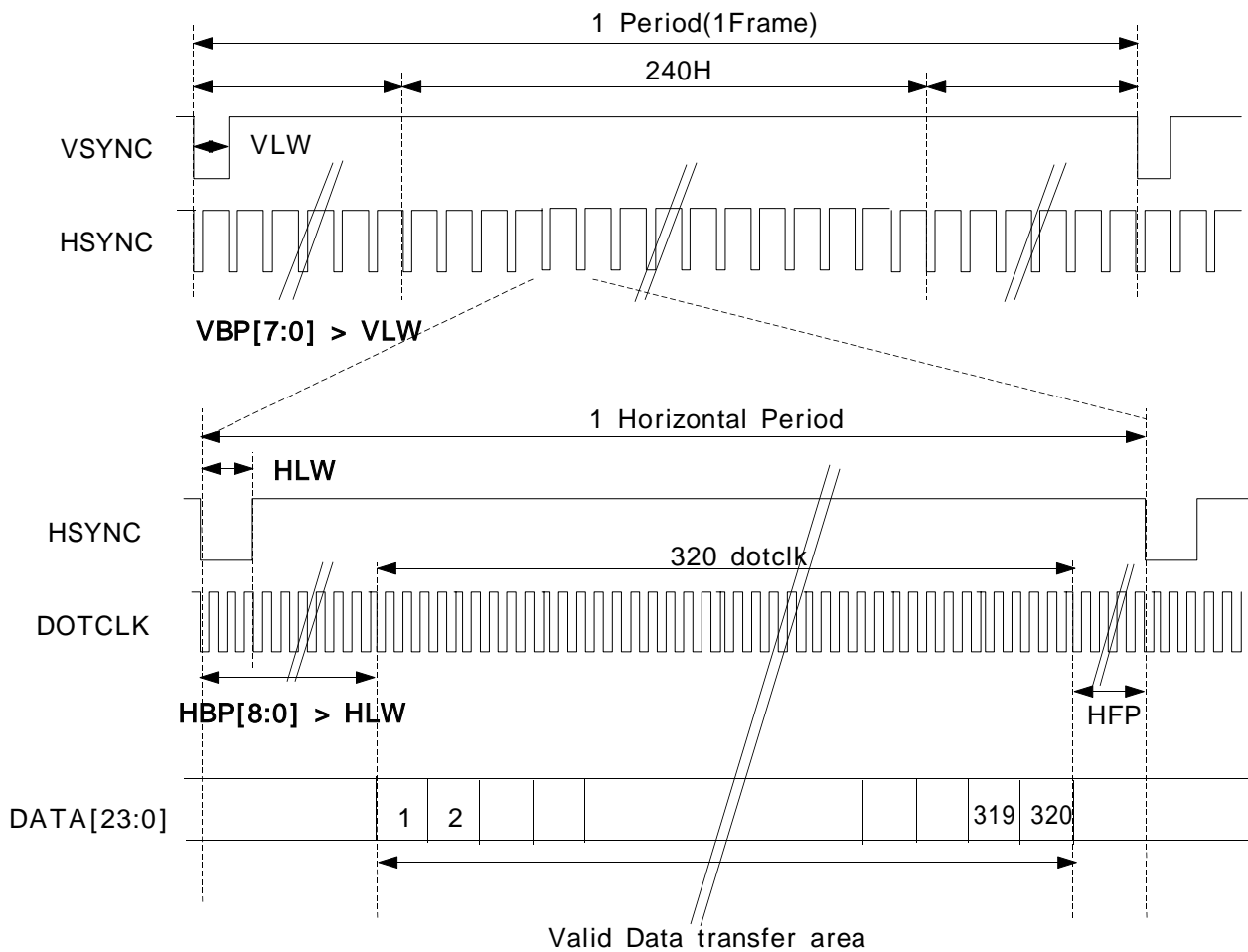

$$* \text{DOTCLK} = f_{\text{frame}} \times (240 + \text{VBP} + \text{VFP}) \times (320 + \text{HBP} + \text{HFP})$$

$$= 60\text{Hz} \times (240 + \text{VBP} + \text{VFP}) \times (320 + \text{HBP} + \text{HFP})$$

$$* \text{VBP} = 3, \text{VBP} > \text{VLW} = 2$$

$$* \text{HBP} = 8, \text{HBP} > \text{HLW} = 2$$

Note 1. Polarity register setting : VPL = 1, HPL = 1, DPL=0

2. The falling edge of DOTCLK is used to fetch display data

7.4 Electrical Specifications

www.DataSheet4U.com

a. RGB Data Interface Characteristics

VCI = 3.3V, T_A = -40 to +85°C

Item	Symbol	Min.	Max.	Unit
Vsync/Hsync Setup Time	t _{SYS}	20	-	ns
Vsync/Hsync Hold Time	t _{SYH}	20	-	
Dotclk Low Level Pulse Width	t _{DCLW}	50	-	
Dotclk High Level Pulse Width	t _{DCHW}	50	-	
Dotclk Cycle Time	t _{DCYC}	100	-	
Data Setup Time	t _{PDS}	40	-	
Data Hold Time	t _{PDH}	40	-	
Dotclk Rise/Fall Time	t _R , t _F	-	10	

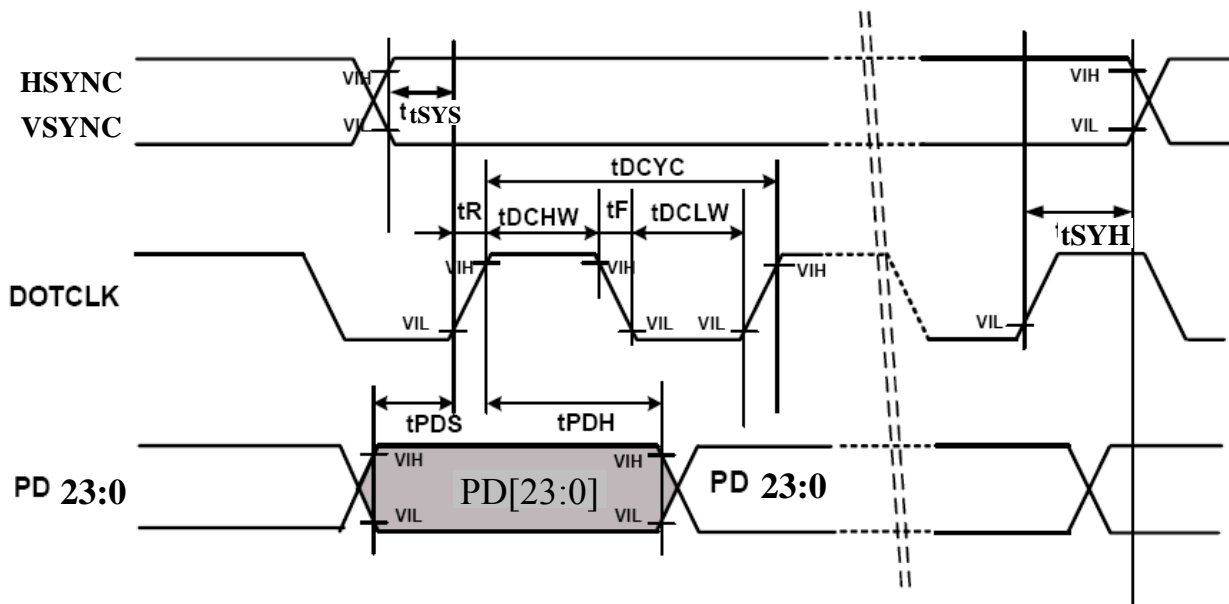

b. Clock Synchronized Serial Mode Characteristics

www.DataSheet4U.com

V_{CI} = 3.3V, T_A = -40 to +85°C

Item	Symbol	Min.	Max.	Unit
Serial Clock Cycle Time	t _{SCYC}	52	-	ns
Serial Clock rise/fall time	t _R ,t _F	-	5	
Pulse width high for write	t _{SCHW}	20	-	
Pulse width high for Read	t _{SCHR}	-	-	
Pulse width low for write	t _{SCLW}	60	-	
Pulse width high for Read	t _{SCLR}	-	-	
Chip Select Setup Time	t _{CSS}	20	-	
Chip Select Hold Time	t _{CSH}	96	-	
Serial Input Data Setup Time	t _{SIDS}	10	-	
Serial Input Data Hold Time	t _{SIDH}	20	-	
Serial Output Data delay Time	t _{SODD}	-	200	
Serial Output Data Hold Time	t _{SODH}	5	-	
Reset Low Pulse Width	t _{RES}	30	-	

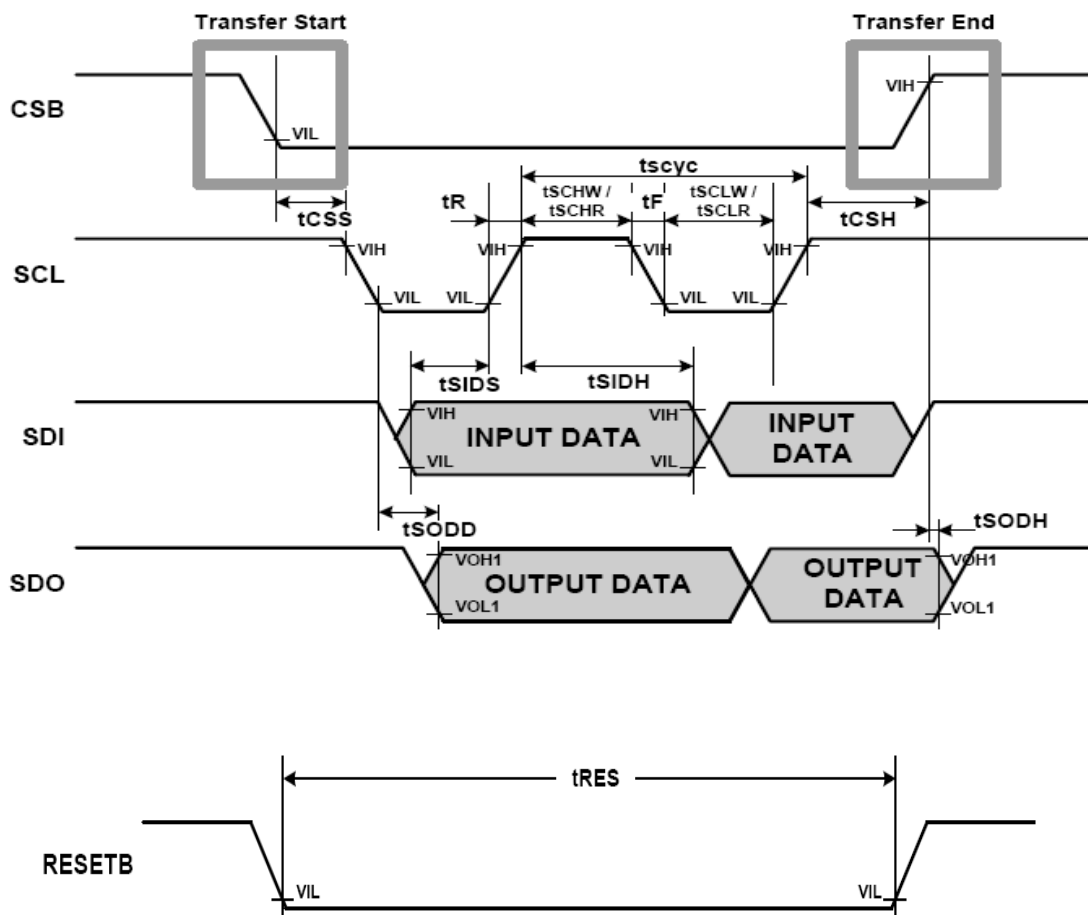

8. Power On/Off Sequence (Register Value can be changed)

www.DataSheet4U.com

8.1 Power On Sequence

< Power On Sequence >

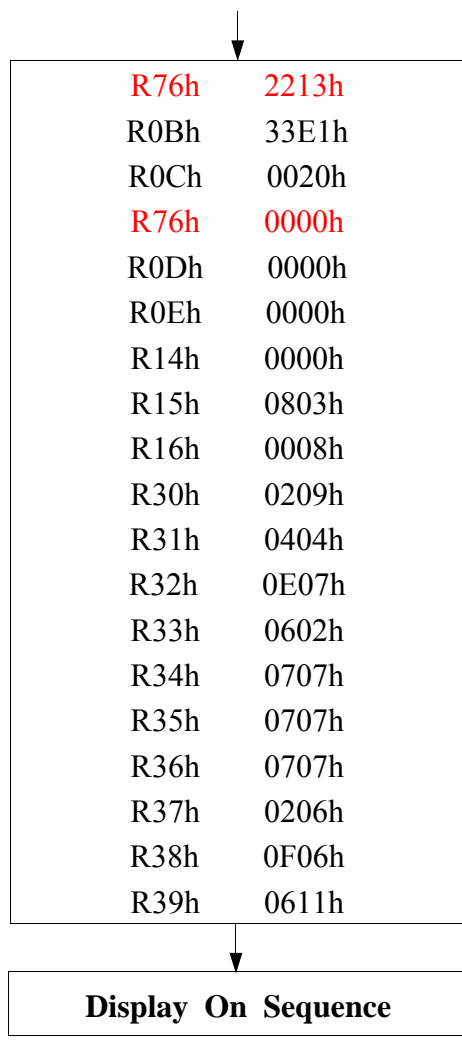
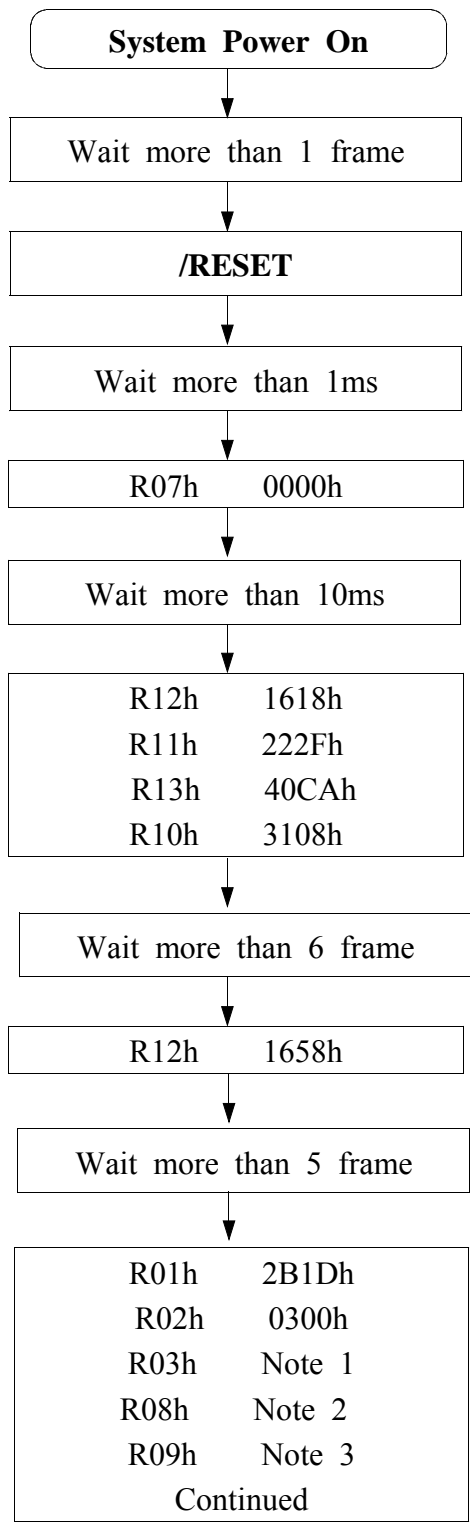

Note 1) RGB INTERFACE MODE

DB15	DB14	DB13	DB12	DB11	DB10	DB9	DB8	DB7	DB6	DB5	DB4	DB3	DB2	DB1	DB0
1	1	0	1	0	0	0	0	0	SYNC _MO	0	0	0	0	0	0

SYNC_MO	RGB Interface mode
0	SYNC with Enable(DE) Mode
1	SYNC without Enable(DE) Mode

Note 2) VBP (Vsync Back Porch)

DB15	DB14	DB13	DB12	DB11	DB10	DB9	DB8	DB7	DB6	DB5	DB4	DB3	DB2	DB1	DB0
0	0	0	0	0	0	0	0	VBP7	VBP6	VBP5	VBP4	VBP3	VBP2	VBP1	VBP0

VBP 7	VBP 6	VBP 5	VBP 4	VBP 3	VBP 2	VBP 1	VBP 0	Number of Raster Periods In the Back Porch
0	0	0	0	0	0	0	0	3
0	0	0	0	0	0	0	1	3
0	0	0	0	0	0	1	0	4
0	0	0	0	0	0	1	1	5
0	0	0	0	0	1	0	0	6
· · ·								· · ·
1	1	1	1	1	1	0	0	254
1	1	1	1	1	1	0	1	255
1	1	1	1	1	1	1	0	256
1	1	1	1	1	1	1	1	257

* The porch period should meet the following condition.

$$VBP \geq 3, VBP > VLW - 2$$

Note 3) HBP (Hsync Back Porch)

DB15	DB14	DB13	DB12	DB11	DB10	DB9	DB8	DB7	DB6	DB5	DB4	DB3	DB2	DB1	DB0
0	0	0	0	0	0	0	HBP8	HBP7	HBP6	HBP5	HBP4	HBP3	HBP2	HBP1	HBP0

HBP 8	HBP 7	HBP 6	HBP 5	HBP 4	HBP 3	HBP 2	HBP 1	HBP 0	Number of MCLKs In the Back Porch 24 bit (8 bit)
0	0	0	0	0	0	0	0	0	8 (24)
0	0	0	0	0	0	0	0	1	8 (24)
0	0	0	0	0	0	0	1	0	8 (24)
0	0	0	0	0	0	0	1	1	8 (24)
0	0	0	0	0	0	1	0	0	8 (24)
0	0	0	0	0	0	1	0	1	8 (24)
0	0	0	0	0	0	1	1	0	8 (24)
0	0	0	0	0	0	1	1	1	8 (24)
0	0	0	0	0	1	0	0	0	8 (24)
0	0	0	0	0	1	0	0	1	9 (27)
0	0	0	0	0	1	0	1	0	10 (30)
0	0	0	0	0	1	0	1	1	11 (33)
·									
·									
·									
1	1	1	1	1	1	1	0	1	509 (1527)
1	1	1	1	1	1	1	1	0	510 (1530)
1	1	1	1	1	1	1	1	1	511 (1533)

* The porch period should meet the following condition.

$$HBP \geq 8, HBP > HLW \geq 2$$

8.2 Display On Sequence

www.DataSheet4U.com

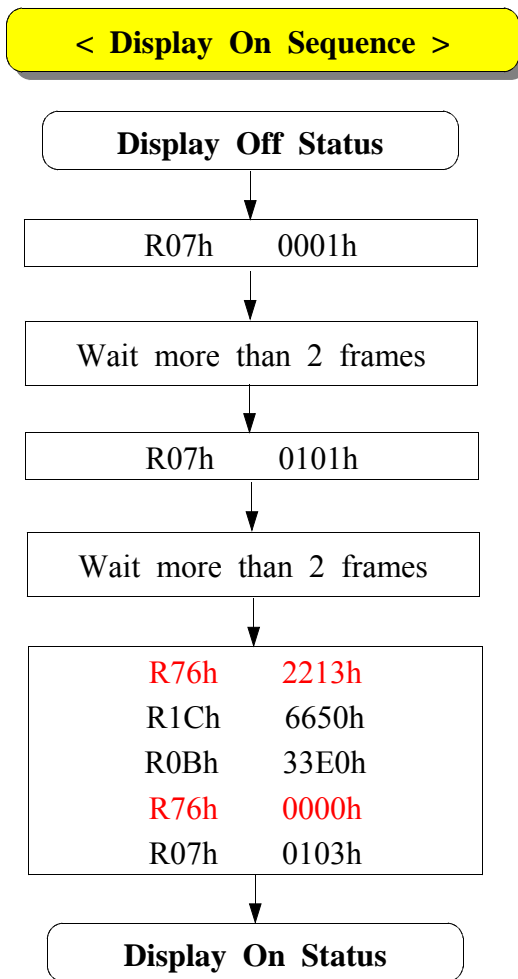

8.3 Display Off Sequence

www.DataSheet4U.com

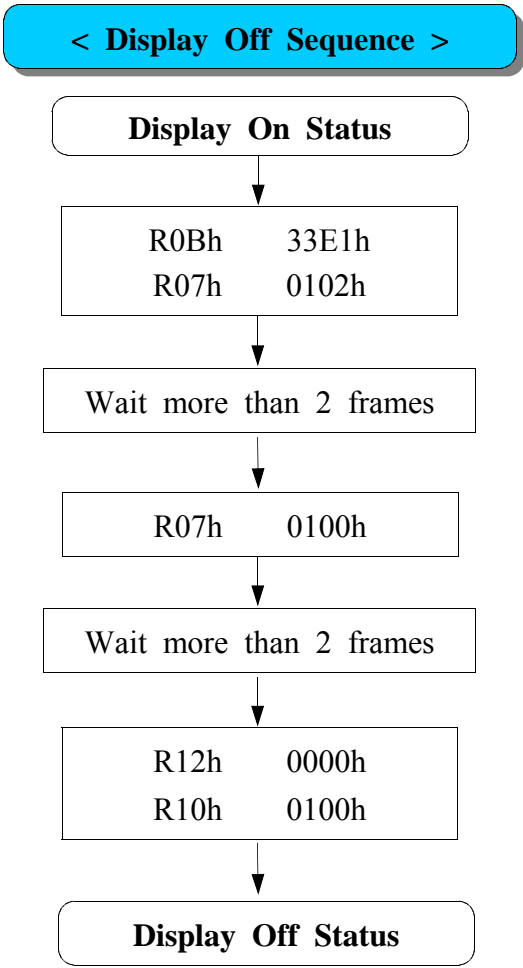

8.4 Power Off Sequence

www.DataSheet4U.com

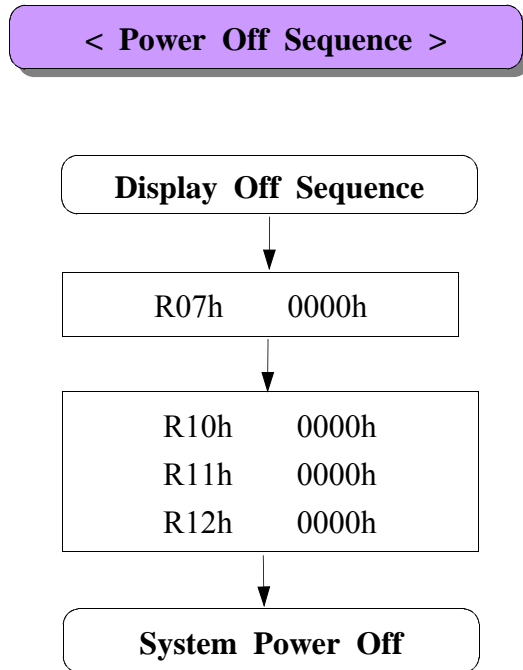

8.5 Stand-by Sequence

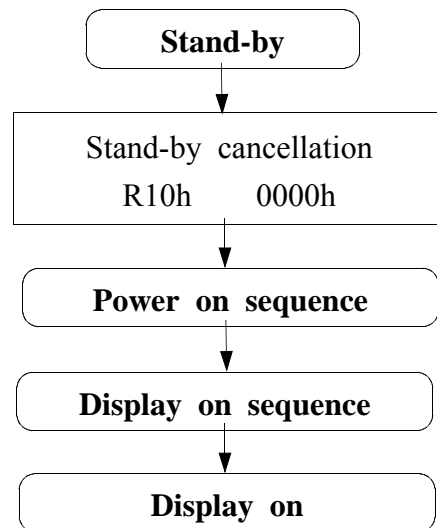
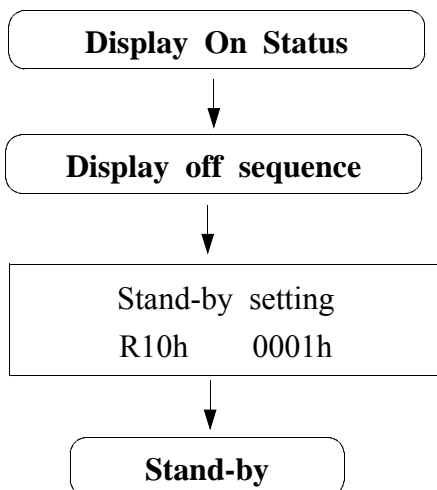

9. RESETB

www.DataSheet4U.com

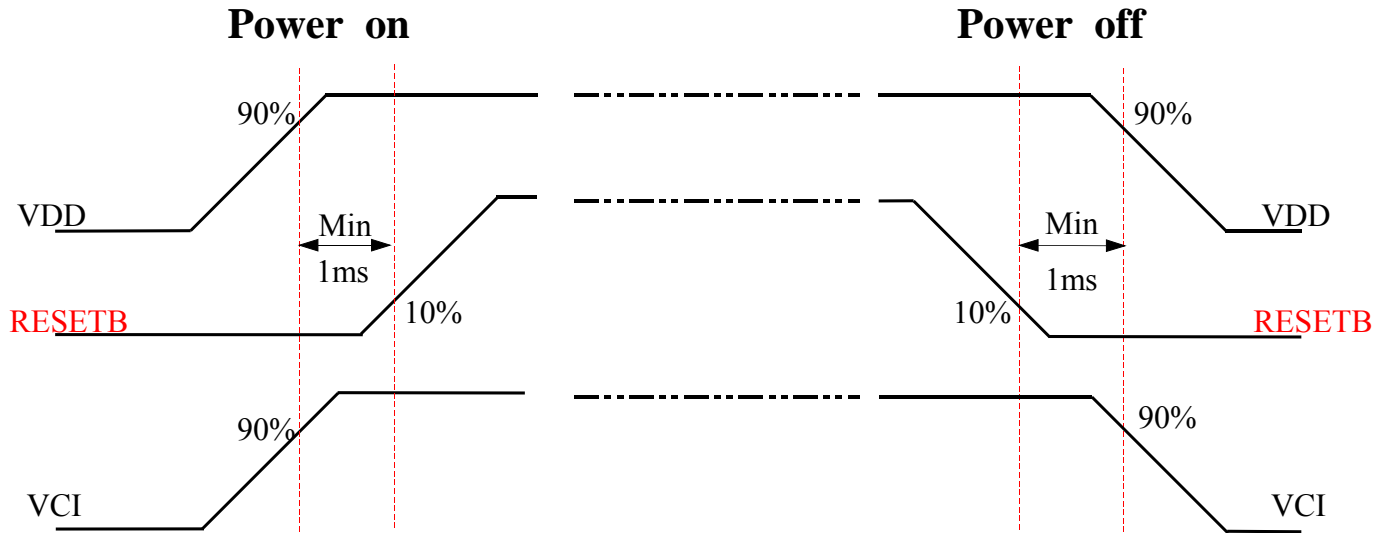

Note : VCI have to get more than 90% level of VCI before control signals are applied

10. Reliability Test Result

10.1 Condition

ITEM	CONDITION	REMARK	Test Result
High Temperature Operating Life-test	70 , 240HR		OK
Low Temperature Operating Life-test	-20 , 240HR		OK
Temperature Humidity Bias test	50 90%RH, 240HR		OK
Temperature Cycle ON/OFF test	-30 70 ON/OFF, 5CY	Note(1)	OK
High Temperature Storage test	70 , 240HR		OK
Low Temperature Storage test	-30 , 240HR		OK
Wet High Temperature Storage test	60 90%RH, 240HR		OK
Thermal Shock test	-30 70 , 100CY	Note(2)	OK
Electro-Static Discharge test	CONTACT: ±4 kV, 20times A I R: ±8 kV, 20times	Note(3)	OK
Box Vibration test	RANDOM 0.74Grms, 1HR/Y axis(SMALL BOX)	Note(4)	OK
Box Drop test	1 Corner 3 Edges 6 faces, 66cm(MEDIUM BOX)		OK
Crunch test	10 kgf, 30s, LCM and T/P don't break	Note(5)	PASS

Note(1) ON Time over 10 seconds, OFF Time under 10 seconds

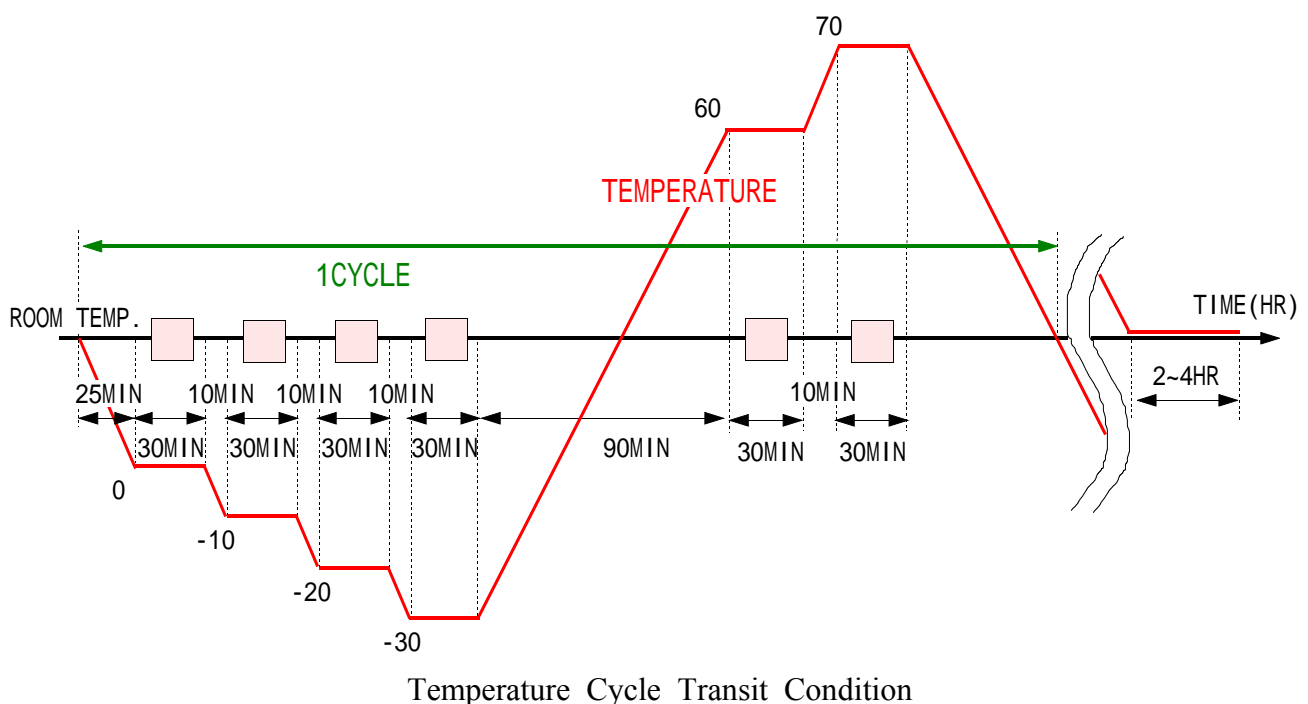

Note(2) STORAGE

www.DataSheet4U.com

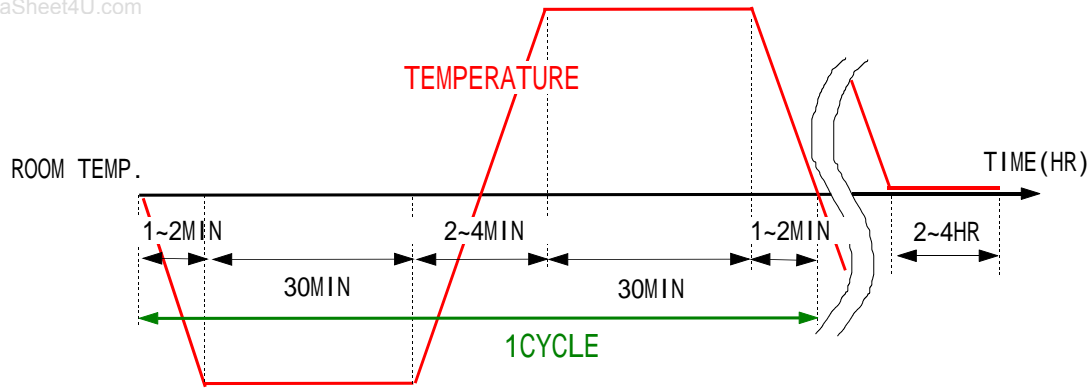

Note(3) Main-LCD, 5 times to every 4 corners of active area

Note(4) Basic transportation by common carrier environmental,
514.4 MIL-STD-810E

OVERAL L RMS LEVEL	BREAK POINT					
	FRQUENC Y	PSD VALUE	FRQUENC Y	PSD VALUE	FRQUENC Y	PSD VALUE
0.74G	10Hz	0.00650	121Hz	0.00300	340Hz	0.00003
	20Hz	0.00650	200Hz	0.00300	500Hz	0.00015
	120Hz	0.00020	240Hz	0.00150	-	-

Note(5)

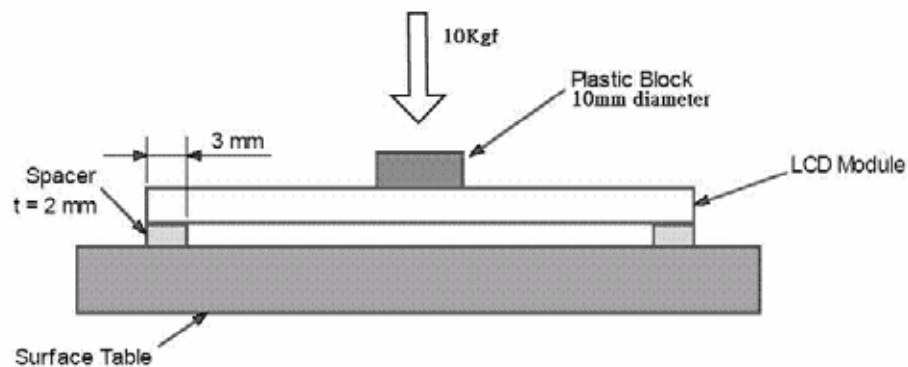

10.2 Judgement

- > Main LCD should work under the normal condition.
- > After the temperature and humidity test,
the luminance and CR(Contrast Ratio) should not be changed over 50% compared with those before the test.

11. Outline Dimension

Approval

www.DataSheet4U.com

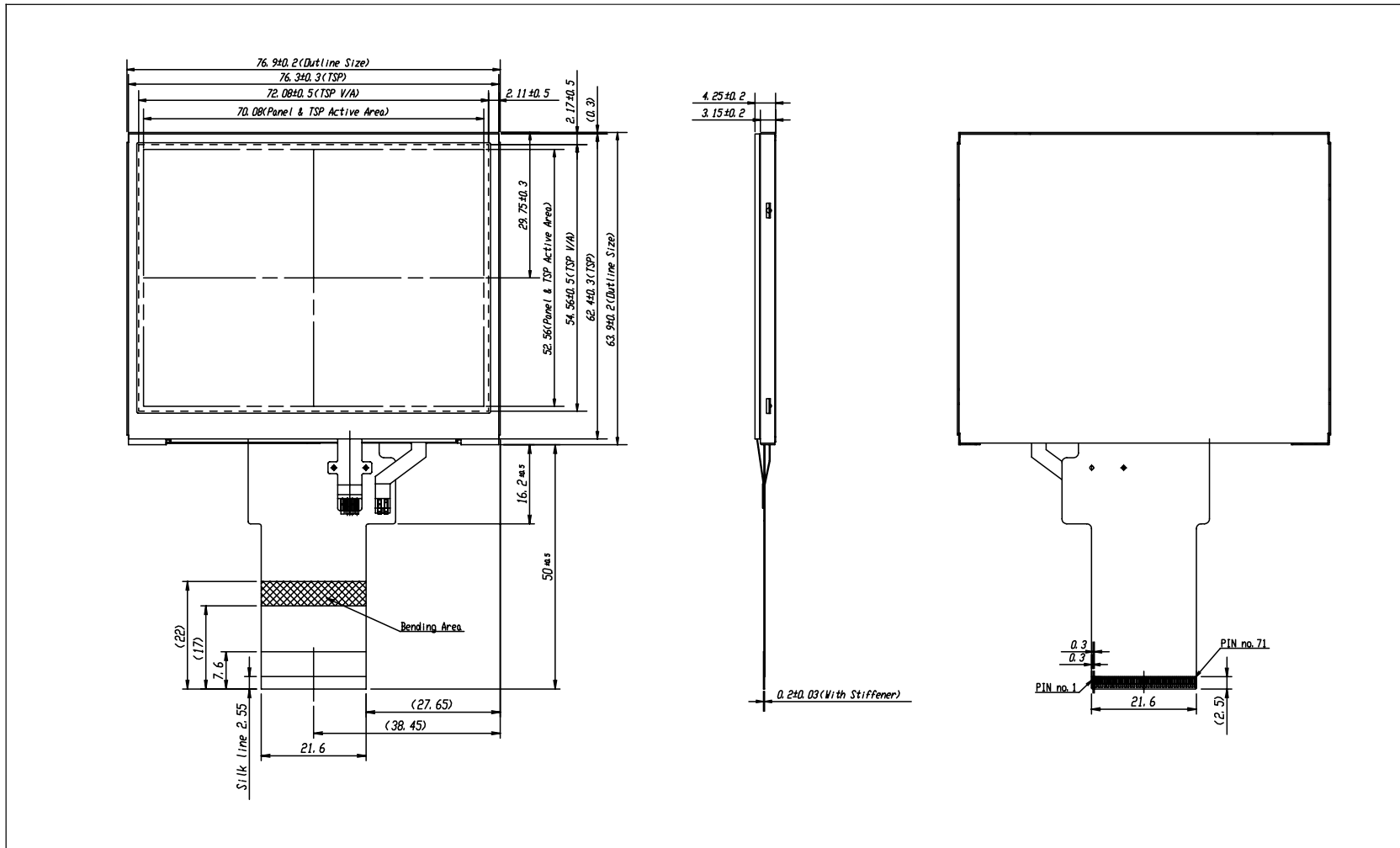

GENERAL TOLERANCE				REV	DATE	DISCUPTION OF REVISION			REASON	CHK' D BY
STEP	LEVEL 1	LEVEL 2	LEVEL 3	UNIT	mm	DRA'N BY	DES' D BY	CHK' D BY	APP' D BY	MODEL NAME
0 < X < 4	±0.05	±0.1	±0.2	SCALE	1/1	W. H. KIM	S. H. LEE	Y. B. CHU		LMS350GF08
4 < X < 16	±0.08	±0.15	±0.3	TOLERANCE		07.05.31	07.05.31	07.05.31		PART/SHEET NAME
16 < X < 64	±0.12	±0.25	±0.5	LEVEL 3						Outline dimension
64 < X < 256	±0.25	±0.4	±0.8	SAMSUNG ELECTRONICS			SPEC. NO			SHEET 1/1
										CODE NO.
										VER. 000

www.DataSheet4U.com

12. Application Circuit (Capacitor value can be changed)

Approval

www.DataSheet4U.com

PIN Assignment

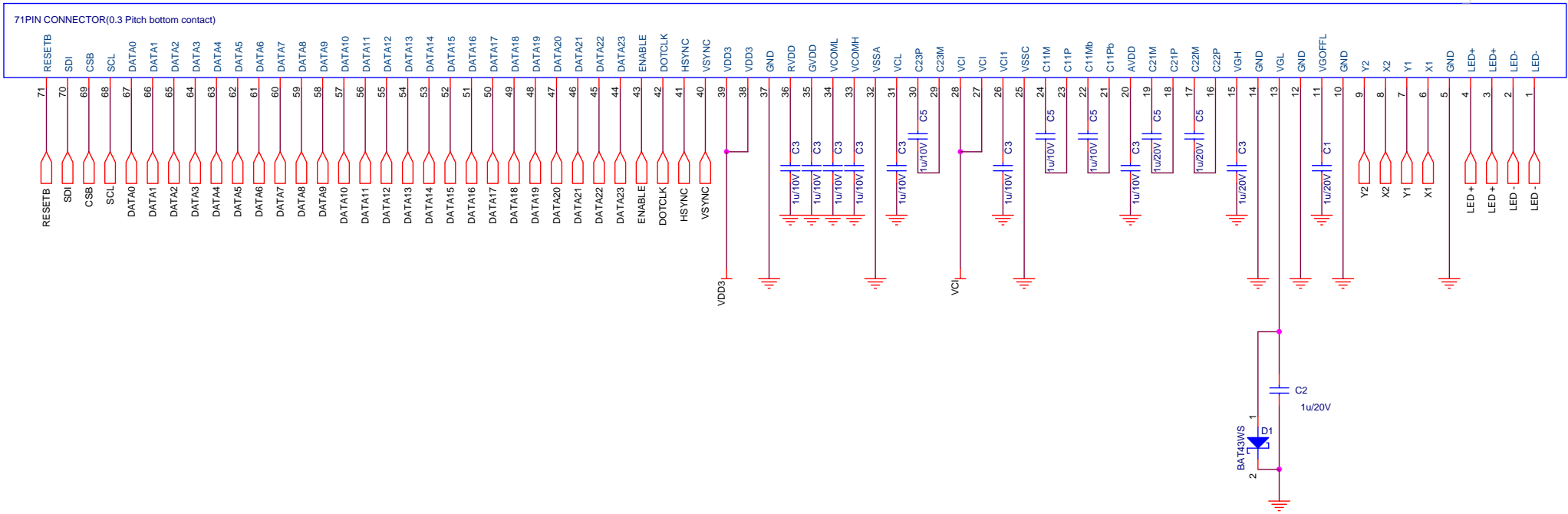

www.DataSheet4U.com

13. Packing

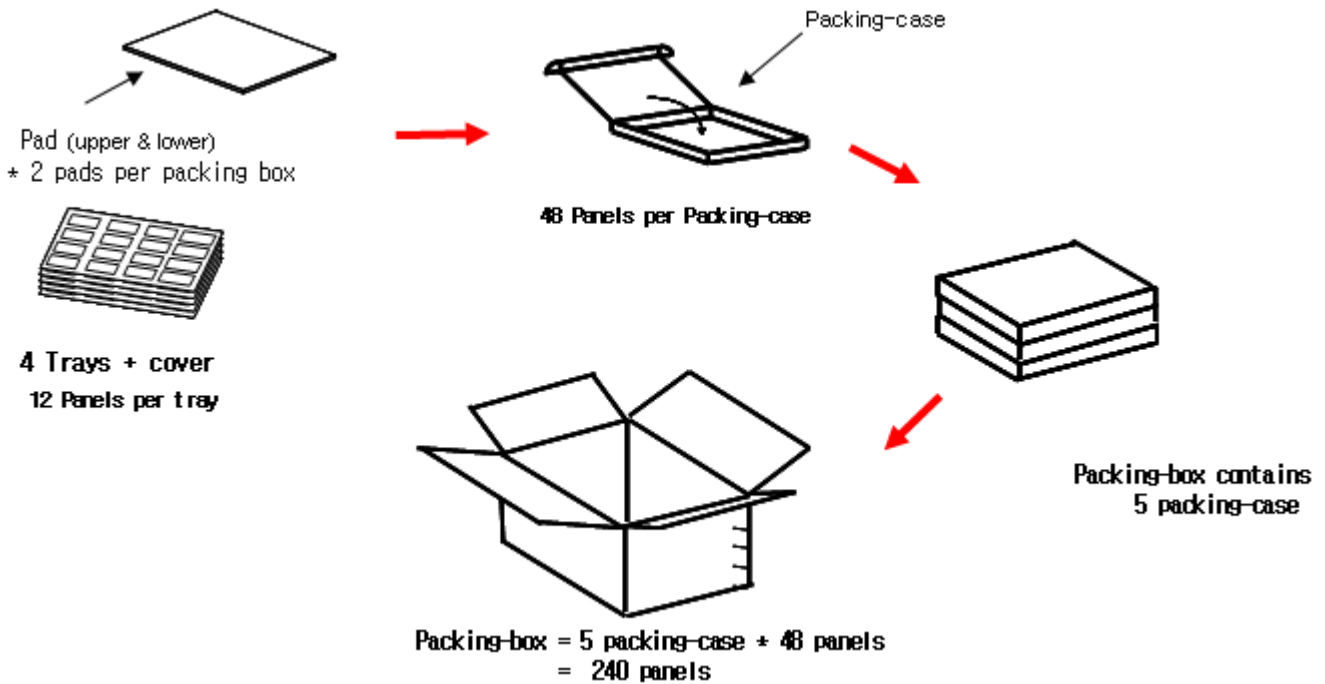

Note

- (1) Total : small box Approx. : 2.78 kg
Packing box Approx. : 14.8 kg
- (2) Size : 505(W) x 355(D) x 200(H)
- (3) Place the panels in the tray facing the direction shown in the figure.
- (4) Seal the packing-box. Affix the label-safety.

14. Marking & Others

A nameplate bearing followed by is affixed to a shipped product at the Specified location on each product.

14.1 Packing case attach

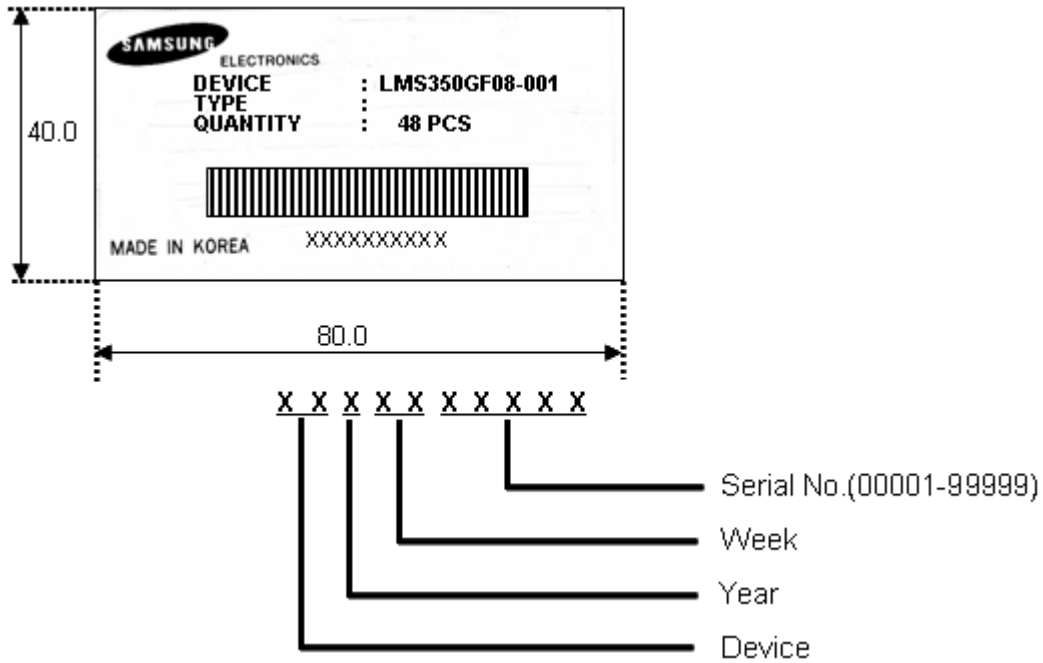

15. General Precautions

15.1 Handling

- (a) When the module is assembled, it should be attached to the system firmly. Be careful not to twist and bend the module.
- (b) Refrain from strong mechanical shock and / or any force to the module. In addition to damage, this may cause improper operation or damage to the module and back-light unit.
- (c) Note that polarizers are very fragile and could be easily damaged. Do not press or scratch the surface harder than a HB pencil lead.
- (d) Wipe off water droplets or oil immediately. If you leave the droplets for a long time, Staining and discoloration may occur.
- (e) If the surface of the polarizer is dirty, clean it using some absorbent cotton or soft cloth.
- (f) The desirable cleaners are water, IPA(Isopropyl Alcohol) or Hexane. Do not use Ketone type materials(ex. Acetone), Ethyl alcohol, Toluene, Ethyl acid or Methyl chloride. It might permanent damage to the polarizer due to chemical reaction.
- (g) If the liquid crystal material leaks from the panel, it should be kept away from the eyes or mouth. In case of contact with hands, legs or clothes, it must be washed away thoroughly with soap.
- (h) Protect the module from static , it may cause damage to the Integrated Gate Circuit.
- (i) Use finger-stalls with soft gloves in order to keep display clean during the incoming inspection and assembly process.
- (j) Do not disassemble the module.
- (k) Protection film for polarizer on the module shall be slowly peeled off just before use so that the electrostatic charge can be minimized.
- (l) Pins of I/F connector shall not be touched directly with bare hands

15.2 Storage

www.DataSheet4U.com

- (a) Do not leave the panel in high temperature, and high humidity for a long time. It is highly recommended to store the module with temperature from 0 to 35°C and relative humidity of less than 70%.
- (b) Do not store the TFT-LCD module in direct sunlight.
- (c) The module shall be stored in a dark place. It is prohibited to apply sunlight or fluorescent light during the store.

15.3 Operation

- (a) Do not connect, disconnect the module in the "Power On" condition.
- (b) Power supply should always be turned on/off by the "Power on/off sequence"

15.4 Others

- (a) The Liquid crystal is deteriorated by ultraviolet, do not leave it in direct sunlight and strong ultraviolet ray for many hours.
- (b) Avoid condensation of water. It may result in improper operation or disconnection of electrode.
- (c) Do not exceed the absolute maximum rating value. (the supply voltage variation, input voltage variation, variation in part contents and environmental temperature, and so on) Otherwise the panel may be damaged.
- (d) If the panel displays the same pattern continuously for a long period of time, it can be the situation when the image "Sticks" to the screen.
- (e) This panel has its circuitry FPC on the bottom side and should be handled carefully in order not to be stressed.
- (f) Avoid shortness between LED soldering pad and TSP soldering pad.