

■ Features :

- Universal AC input / Full range (up to 305VAC)
- Built-in active PFC function, PF>0.95
- Protections: Short circuit / Overload / Over voltage / Over temperature
- Cooling by free air convection
- Output constant current level adjustable
- 100% full load burn-in test
- Three in one dimming function (1~10Vdc or PWM signal or resistance)
- Suitable for built in LED lighting system
- Suitable for dry / damp location
- 3 years warranty



SPECIFICATION

| MODEL | HLP-40H-12 | HLP-40H-15 | HLP-40H-20 | HLP-40H-24 | HLP-40H-30 | HLP-40H-36 | HLP-40H-42 | HLP-40H-48 | HLP-40H-54 | | |
|--|---|--|--------------------------|----------------|--|------------------------------------|------------|------------|--------------------------|------------|--|
| OUTPUT | DC VOLTAGE | 12V | 15V | 20V | 24V | 30V | 36V | 42V | 48V | 54V | |
| | CONSTANT CURRENT REGION <small>Note.4</small> | 7.2~12V | 9~15V | 12~20V | 14.4~24V | 18~30V | 21.6~36V | 25.2~42V | 28.8~48V | 32.4~54V | |
| | RATED CURRENT | 3.33A | 2.67A | 2A | 1.67A | 1.34A | 1.12A | 0.96A | 0.84A | 0.75A | |
| | RATED POWER | 40W | 40W | 40W | 40.1W | 40.2W | 40.3W | 40.3W | 40.3W | 40.5W | |
| | RIPPLE & NOISE (max.) <small>Note.2</small> | 150mVp-p | 150mVp-p | 150mVp-p | 150mVp-p | 200mVp-p | 200mVp-p | 300mVp-p | 300mVp-p | 300mVp-p | |
| | VOLTAGE ADJ. RANGE | 10.8~13.5V | 13.5~17V | 17~22V | 22~27V | 27~33V | 33~40V | 40~46V | 44~53V | 49~58V | |
| | CURRENT ADJ. RANGE | Can be adjusted by internal potential meter or through output cable | | | | | | | | | |
| | | 2~3.33A | 1.6~2.67A | 1.2~2A | 1~1.67A | 0.8~1.34A | 0.67~1.12A | 0.58~0.96A | 0.5~0.84A | 0.45~0.75A | |
| | VOLTAGE TOLERANCE <small>Note.3</small> | ±2.5% | ±2.0% | ±1.0% | ±1.0% | ±1.0% | ±1.0% | ±1.0% | ±1.0% | ±1.0% | |
| | LINE REGULATION | ±0.5% | ±0.5% | ±0.5% | ±0.5% | ±0.5% | ±0.5% | ±0.5% | ±0.5% | ±0.5% | |
| LOAD REGULATION | ±2.0% | ±1.5% | ±1.0% | ±0.5% | ±0.5% | ±0.5% | ±0.5% | ±0.5% | ±0.5% | | |
| SETUP, RISE TIME <small>Note.6</small> | 1500ms, 80ms / 115VAC at full load | | | | | 1000ms, 80ms / 230VAC at full load | | | | | |
| HOLD UP TIME (Typ.) | 16ms/230VAC | | 16ms/115VAC at full load | | | | | | | | |
| INPUT | VOLTAGE RANGE <small>Note.5</small> | 90~305VAC | | 127~431VDC | | | | | | | |
| | FREQUENCY RANGE | 47~63Hz | | | | | | | | | |
| | POWER FACTOR (Typ.) | PF ≥ 0.95/230VAC | | | PF ≥ 0.98/115VAC at full load and rated output voltage | | | | PF ≥ 0.9 at 60~100% load | | |
| | EFFICIENCY (Typ.) | 87% | 87% | 88% | 88% | 89% | 89% | 89.5% | 89.5% | 90% | |
| | AC CURRENT (Typ.) | 0.43A / 115VAC | | 0.24A / 230VAC | | 0.23A / 277VAC | | | | | |
| | INRUSH CURRENT(Typ.) | COLD START 70A/230VAC | | | | | | | | | |
| | LEAKAGE CURRENT | <0.75mA / 277VAC | | | | | | | | | |
| PROTECTION | OVER CURRENT <small>Note.4</small> | 95~108% | | | | | | | | | |
| | OVER VOLTAGE | Protection type : Constant current limiting, recovers automatically after fault condition is removed | | | | | | | | | |
| | | 18~24V | 17.5~30V | 23~30V | 28~35V | 35~43V | 41~49V | 48~58V | 54~63V | 59~66V | |
| OVER TEMPERATURE | 85°C ±10°C (RTH2) | | | | | | | | | | |
| | Protection type : Shut down o/p voltage, re-power on to recover | | | | | | | | | | |
| ENVIRONMENT | WORKING TEMP. | -40~+70°C (Refer to "Derating Curve") | | | | | | | | | |
| | WORKING HUMIDITY | 20~95% RH non-condensing | | | | | | | | | |
| | STORAGE TEMP., HUMIDITY | -40~+80°C, 10~95% RH | | | | | | | | | |
| | TEMP. COEFFICIENT | ±0.03%/°C (0~50°C) | | | | | | | | | |
| | VIBRATION | 10~500Hz, 2G 12min./1cycle, period for 72min. each along X, Y, Z axes | | | | | | | | | |
| SAFETY & EMC | SAFETY STANDARDS | UL8750, EN61347-1, EN61347-2-13 approved ; Design refer to UL60950-1, TUV EN60950-1, EN60335-1 | | | | | | | | | |
| | WITHSTAND VOLTAGE | I/P-O/P:3.75KVAC I/P-FG:1.88KVAC O/P-FG:0.5KVAC | | | | | | | | | |
| | ISOLATION RESISTANCE | I/P-O/P, I/P-FG, O/P-FG:100M Ohms / 500VDC / 25°C / 70% RH | | | | | | | | | |
| | EMC EMISSION | Compliance to EN55015, EN61000-3-2 Class C (≥60% load) ; EN61000-3-3 | | | | | | | | | |
| | EMC IMMUNITY | Compliance to EN61000-4-2,3,4,5,6,8,11; EN61547, EN55024, light industry level (surge 4KV), criteria A | | | | | | | | | |
| OTHERS | MTBF | 287.9Khrs min. MIL-HDBK-217F (25°C) | | | | | | | | | |
| | DIMENSION | 147*53*27mm (L*W*H) | | | | | | | | | |
| | PACKING | 0.2Kg/72pcs/15.4Kg/1.09CUFT | | | | | | | | | |
| NOTE | <ol style="list-style-type: none"> 1. All parameters NOT specially mentioned are measured at 230VAC input, rated load and 25°C of ambient temperature. 2. Ripple & noise are measured at 20MHz of bandwidth by using a 12" twisted pair-wire terminated with a 0.1uf & 47uf parallel capacitor. 3. Tolerance : includes set up tolerance, line regulation and load regulation. 4. Constant current operation region is within 60%~100% rated output voltage. This is the suitable operation region for LED related applications, but please reconfirm special electrical requirements for some specific system design. 5. Derating may be needed under low input voltages. Please check the static characteristics for more details. 6. Length of set up time is measured at cold first start. Turning ON/OFF the power supply may lead to increase of the set up time. 7. The power supply is considered as a component that will be operated in combination with final equipment. Since EMC performance will be affected by the complete installation, the final equipment manufacturers must re-quality EMC Directive on the complete installation again. | | | | | | | | | | |

Mechanical Specification

Unit:mm

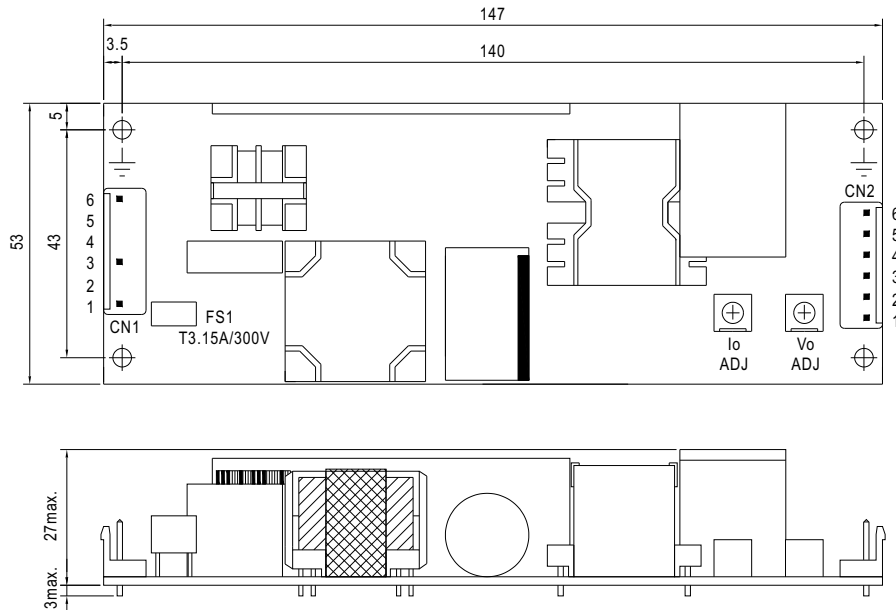

AC Input Connector (CN1) : JST B6P-VH or equivalent

| Pin No. | Assignment | Mating Housing | Terminal |
|---------|------------|-----------------------|--------------------------------|
| 1 | AC/L | JST VHR or equivalent | JST SVH-21T-P1.1 or equivalent |
| 2,4,5 | No Pin | | |
| 3 | AC/N | | |
| 6 | FG \perp | | |

DC Output Connector (CN2) : JST B6P-VH or equivalent

| Pin No. | Assignment | Mating Housing | Terminal |
|---------|------------|-----------------------|--------------------------------|
| 1 | DIM+ | JST VHR or equivalent | JST SVH-21T-P1.1 or equivalent |
| 2 | DIM- | | |
| 3,4 | -V | | |
| 5,6 | +V | | |

Block Diagram

fosc : 100KHz

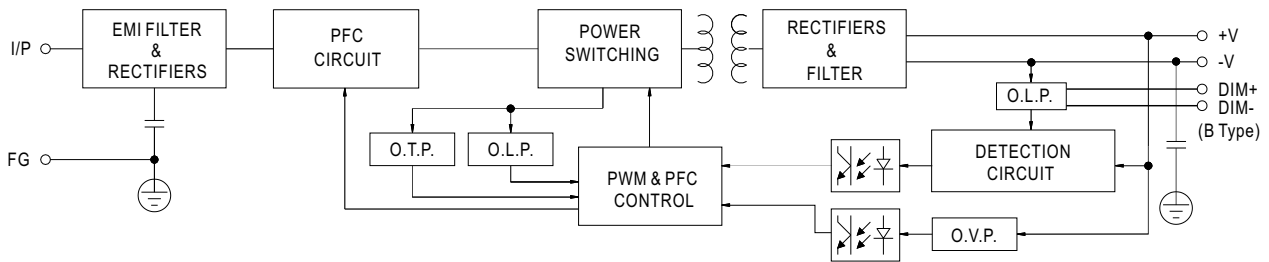

Derating Curve

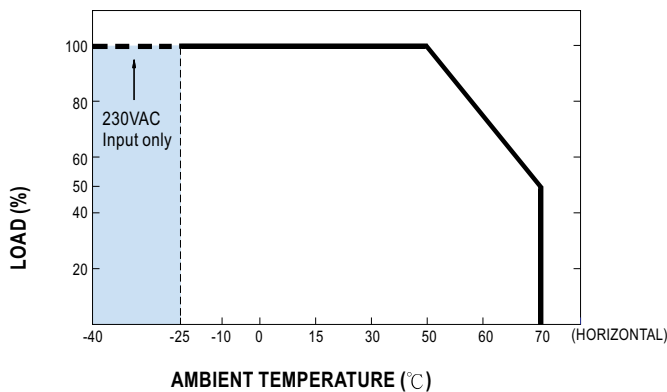

Static Characteristics

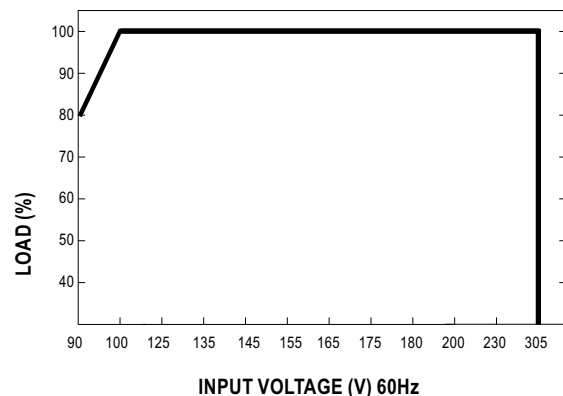

Power Factor Characteristic

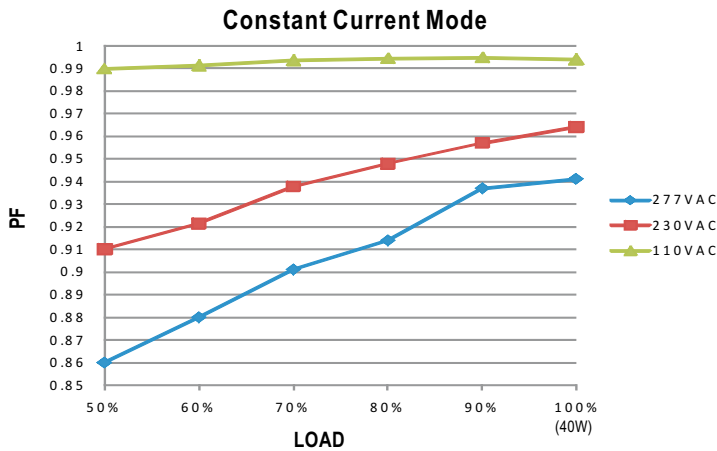

EFFICIENCY vs LOAD (48V Model)

HLP-40H series possess superior working efficiency that up to 90% can be reached in field applications.

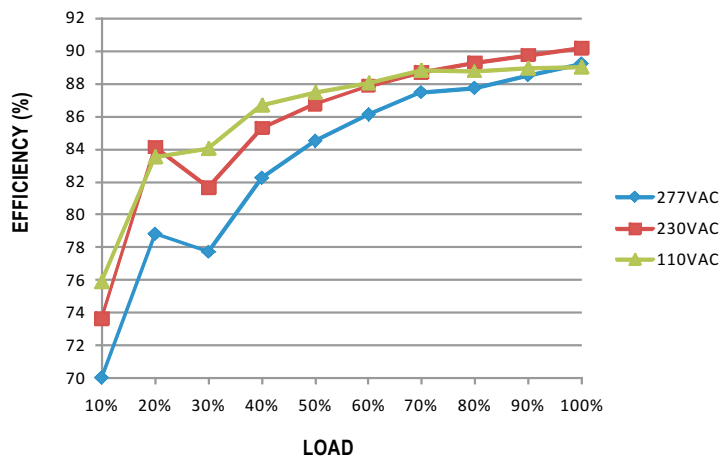

DRIVING METHODS OF LED MODULE

There are two major kinds of LED drive method "direct drive" and "with LED driver".

A typical LED power supply may either work in "constant voltage mode (CV) or constant current mode (CC)" to drive the LEDs.

Mean Well's LED power supply with CV+ CC characteristic can be operated at both CV mode (with LED driver, at area (A) and CC mode (direct drive, at area (B).

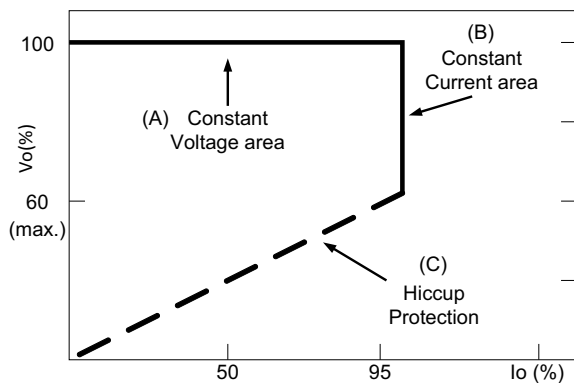

Typical LED power supply I-V curve

DIMMING OPERATION

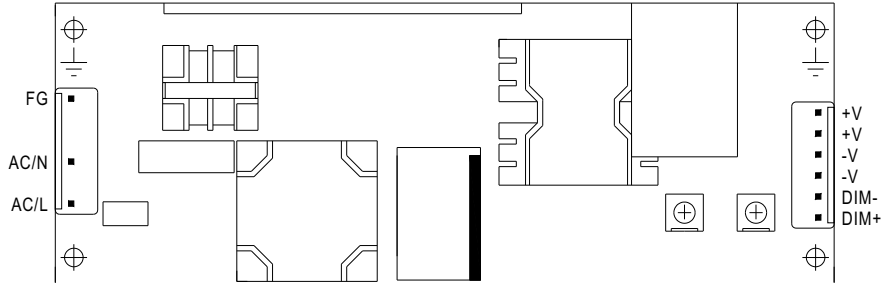

※ Output constant current level can be adjusted through output connector by 1~10VDC, PWM signal, or connecting a resistance between DIM+ and DIM-.

※ Please DO NOT connect "DIM-" to "-V".

※ Reference resistance value for output current adjustment (Typical)

| Resistance value | Single driver | 10KΩ | 20KΩ | 30KΩ | 40KΩ | 50KΩ | 60KΩ | 70KΩ | 80KΩ | 90KΩ | 100KΩ | OPEN |
|-----------------------------|--|--------|--------|--------|--------|--------|--------|--------|--------|--------|---------|----------|
| | Multiple drivers (N=driver quantity for synchronized dimming operation) | 10KΩ/N | 20KΩ/N | 30KΩ/N | 40KΩ/N | 50KΩ/N | 60KΩ/N | 70KΩ/N | 80KΩ/N | 90KΩ/N | 100KΩ/N | ----- |
| Percentage of rated current | | 10% | 20% | 30% | 40% | 50% | 60% | 70% | 80% | 90% | 100% | 95%~105% |

※ 1 ~ 10V dimming function for output current adjustment (Typical)

| Dimming value | 1V | 2V | 3V | 4V | 5V | 6V | 7V | 8V | 9V | 10V | OPEN |
|-----------------------------|-----|-----|-----|-----|-----|-----|-----|-----|-----|------|----------|
| Percentage of rated current | 10% | 20% | 30% | 40% | 50% | 60% | 70% | 80% | 90% | 100% | 95%~105% |

※ 10V PWM signal for output current adjustment (Typical): Frequency range : 100HZ ~ 3KHz

| Duty value | 10% | 20% | 30% | 40% | 50% | 60% | 70% | 80% | 90% | 100% | OPEN |
|-----------------------------|-----|-----|-----|-----|-----|-----|-----|-----|-----|------|----------|
| Percentage of rated current | 10% | 20% | 30% | 40% | 50% | 60% | 70% | 80% | 90% | 100% | 95%~105% |

※ Using the built-in dimming function can't turn the lighting fixture totally dark. Please refer to the connection method below to achieve 0% brightness of the lighting fixture connecting to the LED power supply unit.

Dimming connection diagram for turning the lighting fixture ON/OFF :

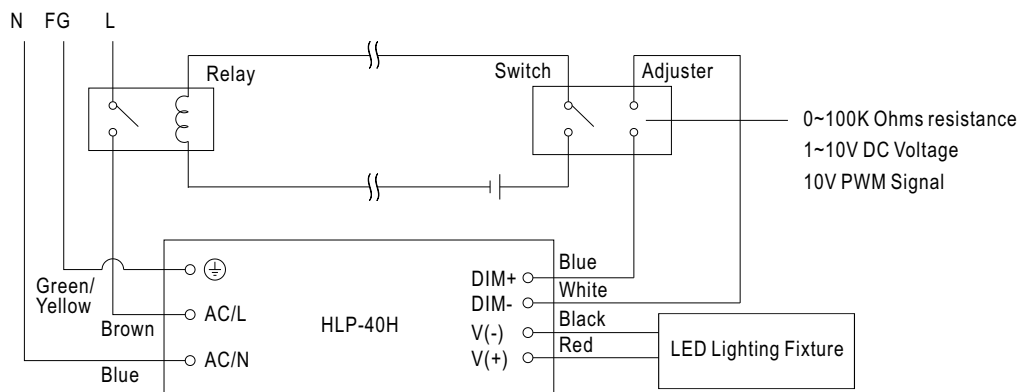

Using a switch and relay can turn ON/OFF the lighting fixture.

1. Output constant current level can be adjusted through output connector by connecting a resistor or 1~10Vdc or 10V PWM signal between DIM+ and DIM-.
2. The LED lighting fixture can be turned ON/OFF by the switch.