

### FEATURES

- **SUPER LOW NOISE FIGURE AND HIGH ASSOCIATED GAIN:**  
NF = 0.55 dB TYP.,  $G_a = 11.5$  dB TYP. @  $V_{DS} = 2$  V,  
 $I_D = 10$  mA,  $f = 12$  GHz
- **FLAT-LEAD 4-PIN THIN-TYPE SUPER MINIMOLD (M04) PACKAGE:**
- **GATE WIDTH:**  
 $W_g = 160$   $\mu$ m

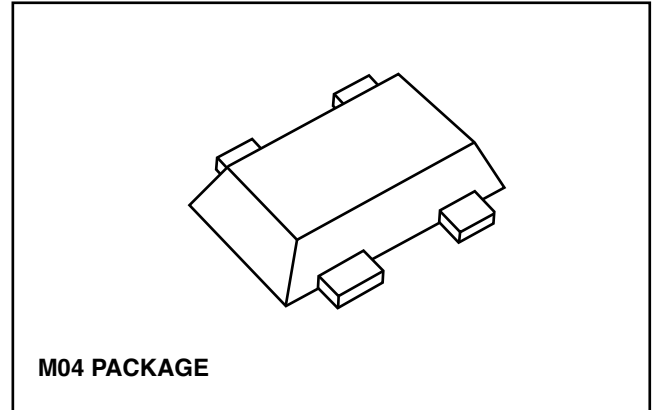

### APPLICATIONS

- DBS LNB gain-stage, Mix-stage
- Low noise amplifier for microwave communication system

### ORDERING INFORMATION

PART NUMBER	QUANTITY	PACKAGE	MARKING	SUPPLYING FORM
NE3503M04-A	50 pcs (Non reel)	4-Pin thin-type super minimold (Pb-Free)	V75	<ul style="list-style-type: none"> <li>• 8 mm wide embossed taping</li> <li>• Pin 1 (Source), Pin 2 (Drain) face the perforation side of the tape</li> </ul>
NE3503M04-T2-A	3 kpcs/reel			

**Remark** To order evaluation samples, contact your nearby sales office.  
Part number for sample order: NE3503M04-A

### ABSOLUTE MAXIMUM RATINGS ( $T_A = +25^\circ\text{C}$ )

PARAMETER	SYMBOL	RATINGS	UNIT
Drain to Source Voltage	$V_{DS}$	4.0	V
Gate to Source Voltage	$V_{GS}$	-3.0	V
Drain Current	$I_D$	$I_{DSS}$	mA
Gate Current	$I_G$	80	$\mu$ A
Total Power Dissipation	$P_{tot}$	125	mW
Channel Temperature	$T_{ch}$	+125	$^\circ\text{C}$
Storage Temperature	$T_{stg}$	-65 to +125	$^\circ\text{C}$

**Caution** Observe precautions when handling because these devices are sensitive to electrostatic discharge.

**RECOMMENDED OPERATING CONDITIONS** ( $T_A = +25^\circ\text{C}$ )

PARAMETER	SYMBOL	MIN.	TYP.	MAX.	UNIT
Drain to Source Voltage	$V_{DS}$	-	2	3	V
Drain Current	$I_D$	-	10	15	mA
Input Power	$P_{in}$	-	-	0	dBm

**ELECTRICAL CHARACTERISTICS** ( $T_A = +25^\circ\text{C}$ , unless otherwise specified)

PARAMETER	SYMBOL	TEST CONDITIONS	MIN.	TYP.	MAX.	UNIT
Gate to Source Leak Current	$I_{GSO}$	$V_{GS} = -3.0\text{ V}$	-	0.5	10	$\mu\text{A}$
Saturated Drain Current	$I_{DSS}$	$V_{DS} = 2\text{ V}, V_{GS} = 0\text{ V}$	15	40	70	mA
Gate to Source Cutoff Voltage	$V_{GS(off)}$	$V_{DS} = 2\text{ V}, I_D = 100\ \mu\text{A}$	-0.2	-0.7	-2.0	V
Transconductance	$g_m$	$V_{DS} = 2\text{ V}, I_D = 10\text{ mA}$	40	55	-	mS
Noise Figure	NF	$V_{DS} = 2\text{ V}, I_D = 10\text{ mA}, f = 12\text{ GHz}$	-	0.55	0.75	dB
Associated Gain	$G_a$		10.5	11.5	-	dB

**TYPICAL CHARACTERISTICS** ( $T_A = +25^\circ\text{C}$ , unless otherwise specified)

**TOTAL POWER DISSIPATION vs. AMBIENT TEMPERATURE**

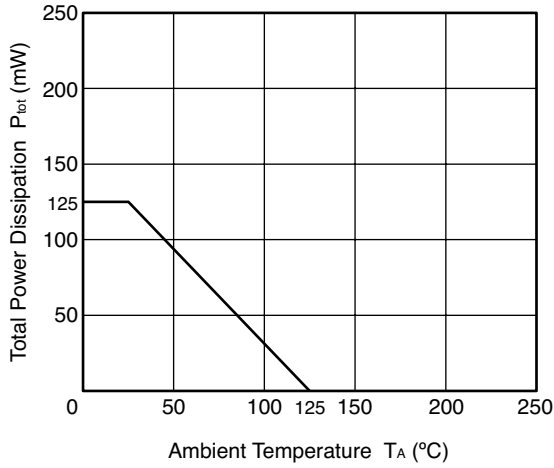

**DRAIN CURRENT vs. DRAIN TO SOURCE VOLTAGE**

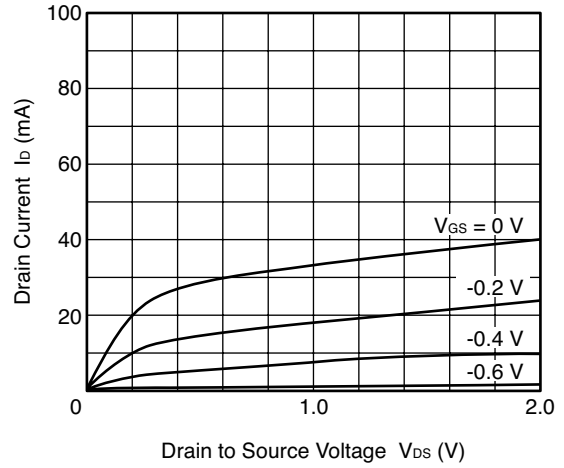

**DRAIN CURRENT vs. GATE TO SOURCE VOLTAGE**

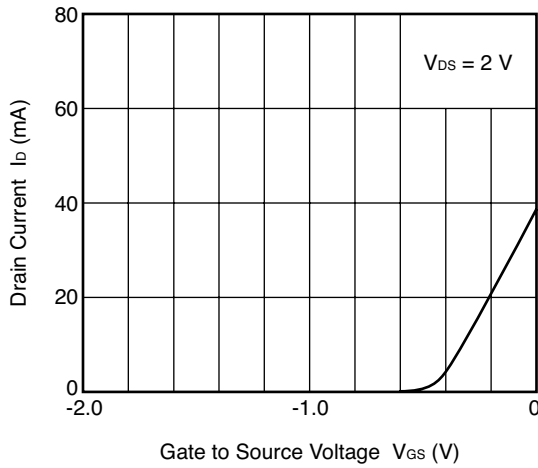

**MINIMUM NOISE FIGURE, ASSOCIATED GAIN vs. DRAIN CURRENT**

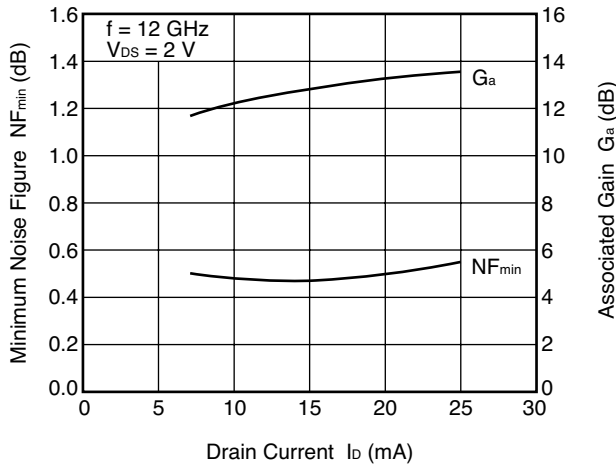

**MINIMUM NOISE FIGURE, ASSOCIATED GAIN vs. FREQUENCY**

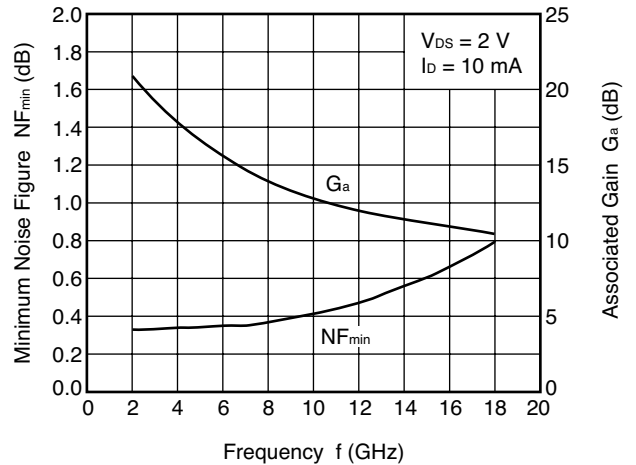

**PACKAGE DIMENSIONS**

FLAT-LEAD 4-PIN THIN-TYPE SUPER MINIMOLD (M04) (UNIT:mm)

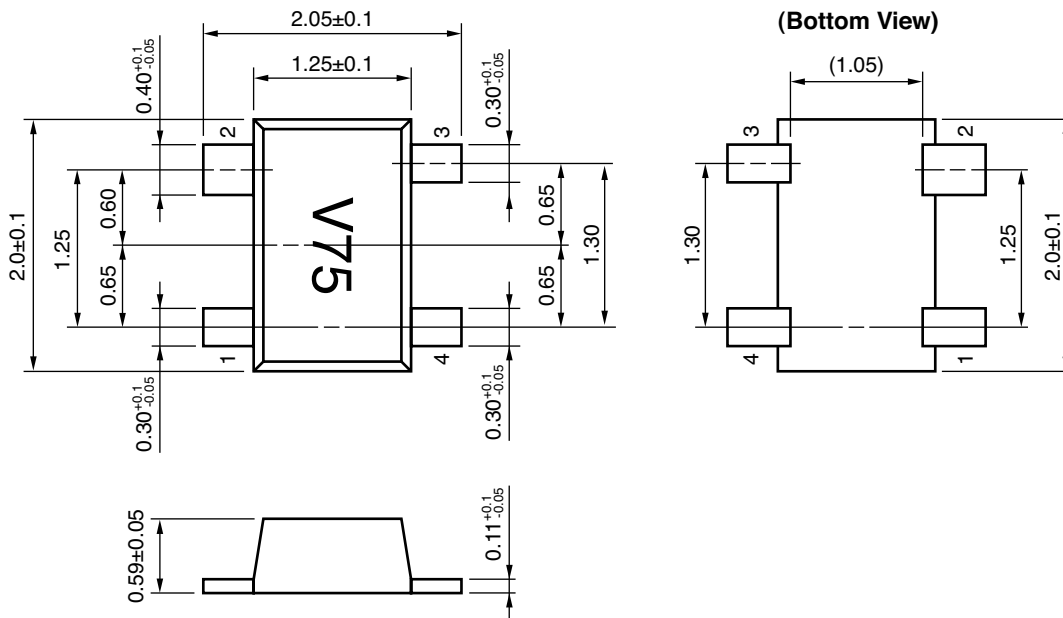
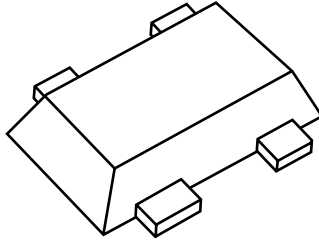
**PIN CONNECTIONS**

1. Source
2. Drain
3. Source
4. Gate

**MOUNTING PAD DIMENSIONS**  
**FLAT-LEAD 4-PIN THIN-TYPE SUPER MINIMOLD (M04) PACKAGE (UNIT:mm)**

Reference 1

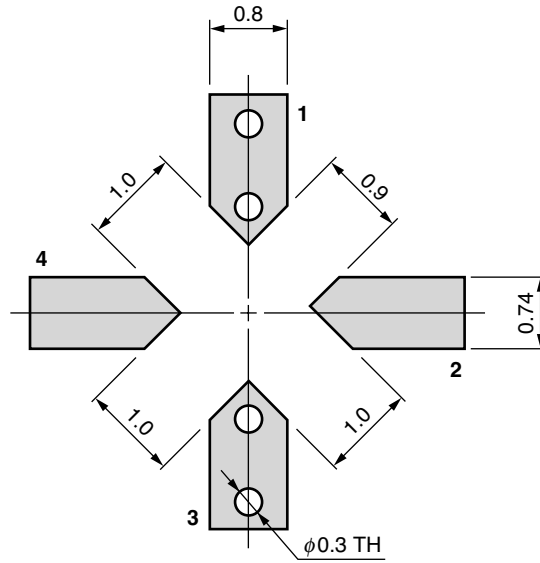

Reference 2

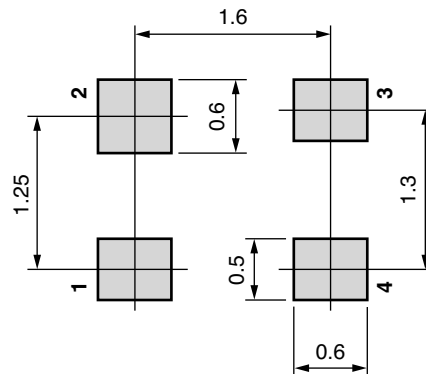

## RECOMMENDED SOLDERING CONDITIONS

This product should be soldered and mounted under the following recommended conditions. For soldering methods and conditions other than those recommended below, contact your nearby sales office.

Soldering Method	Soldering Conditions	Condition Symbol
Infrared Reflow	Peak temperature (package surface temperature) : 260°C or below Time at peak temperature : 10 seconds or less Time at temperature of 220°C or higher : 60 seconds or less Preheating time at 120 to 180°C : 120±30 seconds Maximum number of reflow processes : 3 times Maximum chlorine content of rosin flux (% mass) : 0.2%(Wt.) or below	IR260
Partial Heating	Peak temperature (pin temperature) : 350°C or below Soldering time (per side of device) : 3 seconds or less Maximum chlorine content of rosin flux (% mass) : 0.2%(Wt.) or below	HS350

**Caution** Do not use different soldering methods together (except for partial heating).

### Life Support Applications

These NEC products are not intended for use in life support devices, appliances, or systems where the malfunction of these products can reasonably be expected to result in personal injury. The customers of CEL using or selling these products for use in such applications do so at their own risk and agree to fully indemnify CEL for all damages resulting from such improper use or sale.

**CEL** California Eastern Laboratories, Your source for NEC RF, Microwave, Optoelectronic, and Fiber Optic Semiconductor Devices.

4590 Patrick Henry Drive • Santa Clara, CA 95054-1817 • (408) 988-3500 • FAX (408) 988-0279 • [www.cel.com](http://www.cel.com)

DATA SUBJECT TO CHANGE WITHOUT NOTICE

03/04/2005

Subject: Compliance with EU Directives

CEL certifies, to its knowledge, that semiconductor and laser products detailed below are compliant with the requirements of European Union (EU) Directive 2002/95/EC Restriction on Use of Hazardous Substances in electrical and electronic equipment (RoHS) and the requirements of EU Directive 2003/11/EC Restriction on Penta and Octa BDE.

CEL Pb-free products have the same base part number with a suffix added. The suffix –A indicates that the device is Pb-free. The –AZ suffix is used to designate devices containing Pb which are exempted from the requirement of RoHS directive (\*). In all cases the devices have Pb-free terminals. All devices with these suffixes meet the requirements of the RoHS directive.

This status is based on CEL’s understanding of the EU Directives and knowledge of the materials that go into its products as of the date of disclosure of this information.

Restricted Substance per RoHS	Concentration Limit per RoHS (values are not yet fixed)	Concentration contained in CEL devices	
		-A	-AZ
Lead (Pb)	< 1000 PPM	Not Detected	(*)
Mercury	< 1000 PPM	Not Detected	
Cadmium	< 100 PPM	Not Detected	
Hexavalent Chromium	< 1000 PPM	Not Detected	
PBB	< 1000 PPM	Not Detected	
PBDE	< 1000 PPM	Not Detected	

If you should have any additional questions regarding our devices and compliance to environmental standards, please do not hesitate to contact your local representative.

**Important Information and Disclaimer:** Information provided by CEL on its website or in other communications concerning the substance content of its products represents knowledge and belief as of the date that it is provided. CEL bases its knowledge and belief on information provided by third parties and makes no representation or warranty as to the accuracy of such information. Efforts are underway to better integrate information from third parties. CEL has taken and continues to take reasonable steps to provide representative and accurate information but may not have conducted destructive testing or chemical analysis on incoming materials and chemicals. CEL and CEL suppliers consider certain information to be proprietary, and thus CAS numbers and other limited information may not be available for release.

In no event shall CEL’s liability arising out of such information exceed the total purchase price of the CEL part(s) at issue sold by CEL to customer on an annual basis.

See CEL Terms and Conditions for additional clarification of warranties and liability.