

### DESCRIPTION

TOKO's CHM1608U Series is a multilayer ceramic balun transformer designed for a variety of wireless applications. TOKO's proprietary material and filter design expertise provide for excellent performance and exceptional reliability in this economical and compact integrated ceramic structure.

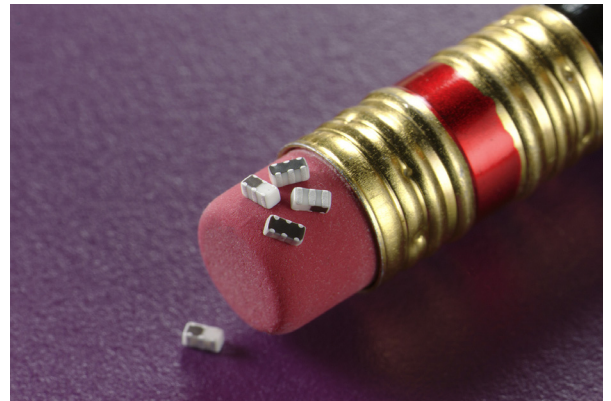

### FEATURES

- Miniature footprint: 1.6 x 0.8mm
- Low profile: 0.9 mm max.
- Integrated ceramic structure
- Operating temperature: - 55°C to + 125°C
- Reflow solderable

### DIMENSIONS

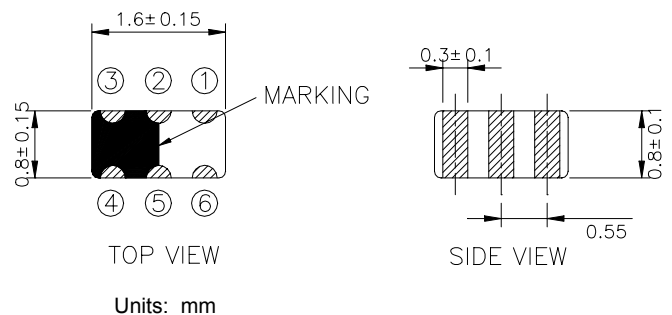

3	NC	2	DC Bias or GND	1	Balanced Port
4	Unbalanced Port	5	GND	6	Balanced Port

### ELECTRICAL SPECIFICATIONS

TOKO Part Number	Passband (MHz)	Unbalanced Port Impedance ( $\Omega$ )	Balanced Port Impedance ( $\Omega$ )	Insertion Loss (dB) max.	Return Loss (dB) min.	Phase Imbalance (deg.)	Amplitude Balance (deg.)
CHM1608U-F2R4AD	2400 - 2500	50	50	1.1	10	180 $\pm$ 8	0 $\pm$ 1.5
CHM1608U-F2R4BD	2400 - 2500	50	100	1.2	10	180 $\pm$ 8	0 $\pm$ 1.5
CHM1608U-F2R4CD	2400 - 2500	50	200	1.2	10	180 $\pm$ 8	0 $\pm$ 1.5

### CHM1608U-F2R4AD

**Insertion Loss and Return Loss**

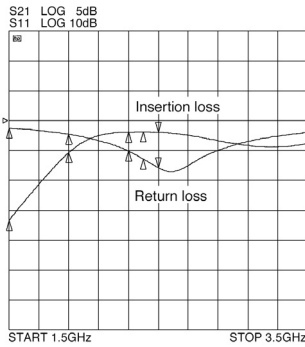

**Phase**

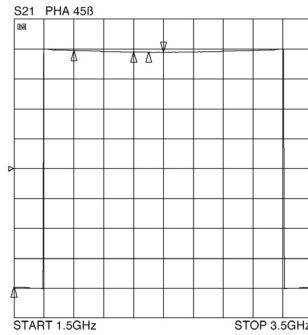

### CHM1608U-F2R4BD

**Insertion Loss and Return Loss**

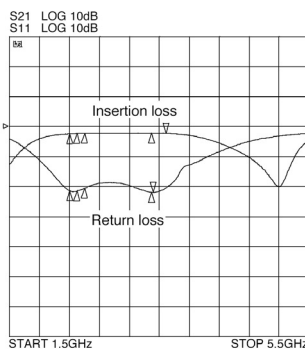

**Phase**

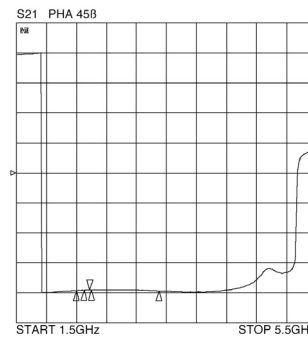

### CHM1608U-F2R4CD

**Insertion Loss and Return Loss**

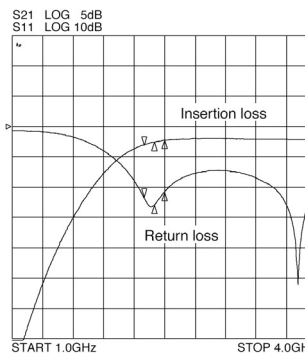

**Phase**

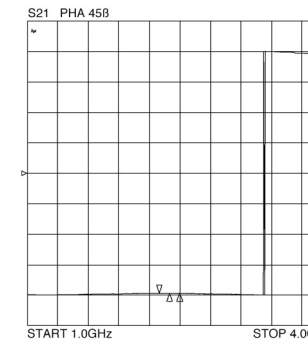

The information furnished by TOKO, Inc., is believed to be accurate and reliable. However, TOKO reserves the right to make changes or improvements in the design, specification, or manufacture of its products without further notice. TOKO does not assume any liability arising from the application or use of any product or circuit described herein, nor for infringements of patents or other rights of third parties which may result from the use of its products. No license is granted by implication or otherwise under any patent or patent rights of TOKO, Inc.