



COLOR TV

SERVICE MANUAL

CHASSIS : MC-049C

MODEL : 21FS2RLX

21FS2RLX-ZC

CAUTION

BEFORE SERVICING THE CHASSIS,
READ THE SAFETY PRECAUTIONS IN THIS MANUAL.

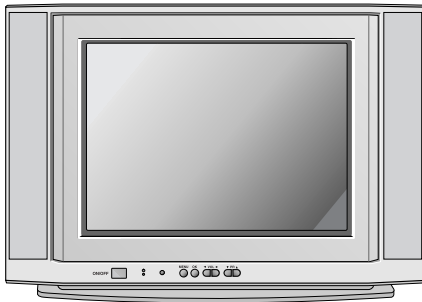

CONTENTS

Contents	2
Safety Precautions.....	3
Control Descriptions.....	4
Specifications	7
Adjustment Instructions	8
Trouble Shooting.....	12
Printed circuit board.....	16
Block Diagram.....	18
Exploded View	20
Exploded View Parts List	21
Replacement Parts List	22
SVC. Sheet.....	

SAFETY PRECAUTIONS

IMPORTANT SAFETY NOTICE

Many electrical and mechanical parts in this chassis have special safety-related characteristics. These parts are identified by Δ in the Schematic Diagram and Replacement Parts List.

It is essential that these special safety parts should be replaced with the same components as recommended in this manual to prevent X-RADIATION, Shock, Fire, or other Hazards.

Do not modify the original design without permission of manufacturer.

General Guidance

An **isolation Transformer should always be used** during the servicing of a receiver whose chassis is not isolated from the AC power line. Use a transformer of adequate power rating as this protects the technician from accidents resulting in personal injury from electrical shocks.

It will also protect the receiver and its components from being damaged by accidental shorts of the circuitry that may be inadvertently introduced during the service operation.

If any fuse (or Fusible Resistor) in this TV receiver is blown, replace it with the specified.

When replacing a high wattage resistor (Oxide Metal Film Resistor, over 1W), keep the resistor 10mm away from PCB.

Keep wires away from high voltage or high temperature parts.

Due to high vacuum and large surface area of picture tube, extreme care should be used in **handling the Picture Tube**. Do not lift the Picture tube by its Neck.

X-RAY Radiation

Warning:

The source of X-RAY RADIATION in this TV receiver is the High Voltage Section and the Picture Tube. For continued X-RAY RADIATION protection, the replacement tube must be the same type tube as specified in the Replacement Parts List.

To determine the presence of high voltage, use an accurate high impedance HV meter.

Adjust brightness, color, contrast controls to minimum.

Measure the high voltage.

The meter reading should indicate

23.5 ; 15KV: 14-19 inch, 26 ; 15KV: 19-21 inch,

29.0 ; 15KV: 25-29 inch, 30.0 ; 15KV: 32 inch

If the meter indication is out of tolerance, immediate service and correction is required to prevent the possibility of premature component failure.

Before returning the receiver to the customer,

always perform an **AC leakage current check** on the exposed metallic parts of the cabinet, such as antennas, terminals, etc., to be sure the set is safe to operate without damage of electrical shock.

Leakage Current Cold Check(Antenna Cold Check)

With the instrument AC plug removed from AC source, connect an electrical jumper across the two AC plug prongs. Place the AC switch in the on position, connect one lead of ohm-meter to the AC plug prongs tied together and touch other ohm-meter lead in turn to each exposed metallic parts such as antenna terminals, phone jacks, etc.

If the exposed metallic part has a return path to the chassis, the measured resistance should be between $1M\Omega$ and $5.2M\Omega$.

When the exposed metal has no return path to the chassis the reading must be infinite.

An other abnormality exists that must be corrected before the receiver is returned to the customer.

Leakage Current Hot Check (See below Figure)

Plug the AC cord directly into the AC outlet.

Do not use a line Isolation Transformer during this check.

Connect 1.5K/10watt resistor in parallel with a 0.15uF capacitor between a known good earth ground (Water Pipe, Conduit, etc.) and the exposed metallic parts.

Measure the AC voltage across the resistor using AC voltmeter with 1000 ohms/volt or more sensitivity.

Reverse plug the AC cord into the AC outlet and repeat AC voltage measurements for each exposed metallic part. Any voltage measured must not exceed 0.75 volt RMS which is corresponds to 0.5mA.

In case any measurement is out of the limits specified, there is possibility of shock hazard and the set must be checked and repaired before it is returned to the customer.

Leakage Current Hot Check circuit

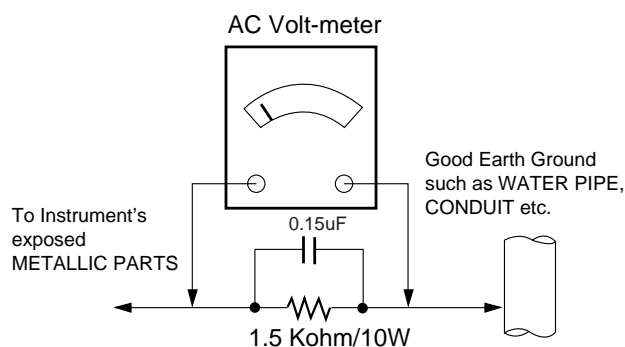

DESCRIPTION OF CONTROLS

All the functions can be controlled with the remote control handset. Some functions can also be adjusted with the buttons on the front panel of the set.

Remote control handset

Before you use the remote control handset, please install the batteries. See the next page.

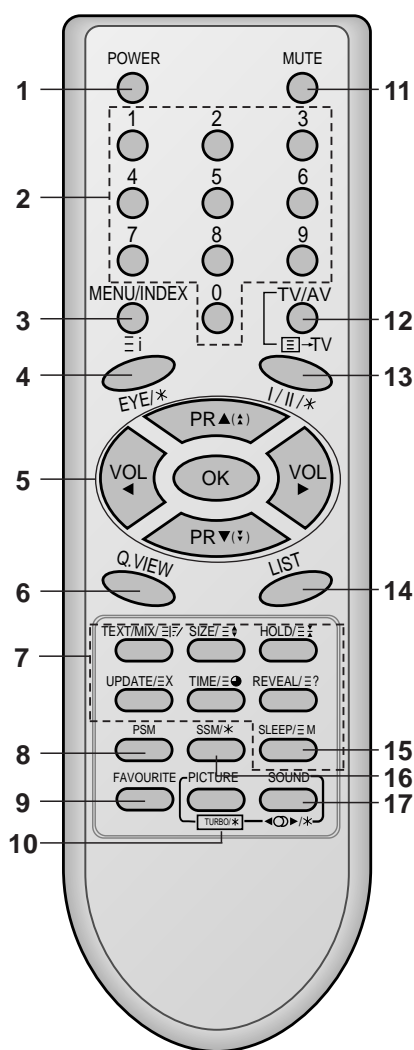

(With TELETEXT)

1. **POWER**
switches the set on from standby or off to standby.
2. **NUMBER BUTTONS**
switches the set on from standby or directly select a number.
3. **MENU (or INDEX)**
selects a menu.
selects an index page in the teletext mode (only TELETEXT models). (option)
4. **EYE/* (option)**
switches the eye function on or off.
5. **▲ / ▼ (Programme Up/Down)**
selects a programme or a menu item.
switches the set on from standby.
scans programmes automatically.
◀ / ▶ (Volume Up/Down)
adjusts the volume.
adjusts menu settings.
OK
accepts your selection or displays the current mode.
6. **Q.VIEW**
returns to the previously viewed programme.
7. **TELETEXT BUTTONS (option)**
These buttons are used for teletext.
For further details, see the 'Teletext' section.
8. **PSM (Picture Status Memory)**
recalls your preferred picture setting.
9. **FAVOURITE**
selects a favorite programme.
10. **TURBO PICTURE / SOUND BUTTON (option)**
selects Turbo picture and sound.

11. MUTE

switches the sound on or off.

12. TV/AV

selects TV or AV mode.
switches the set on from standby.

13. I/II/* (option)

selects the language during dual language broadcast. (option)
selects the sound output.

14. LIST

displays the programme table.

15. SLEEP

sets the sleep timer.

16. SSM/* (Sound Status Memory) (option)

recalls your preferred sound setting.

17. SURROUND (◀▶)/* (option)

selects surround sound.

*** : No function**

COLOURED BUTTONS : These buttons are used for teletext (only TELETEXT models) or programme edit.

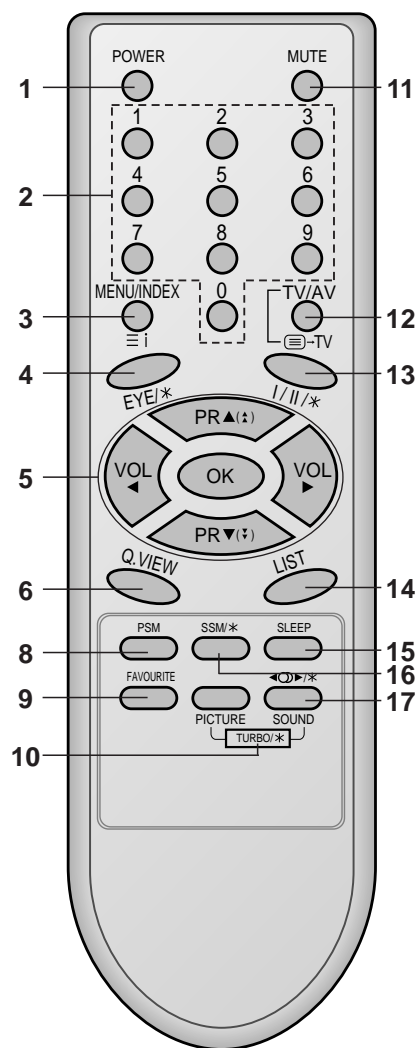

(Without TELETEXT)

Front panel

21FS2 series

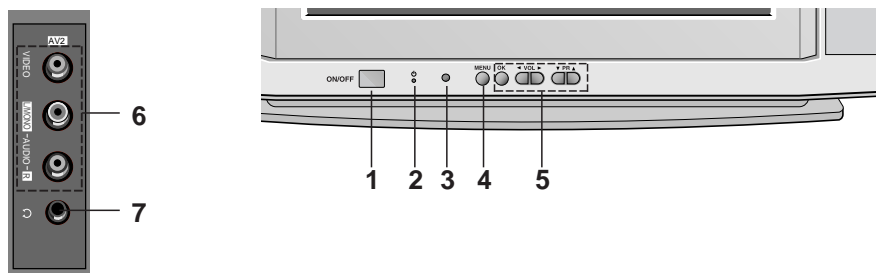

Side panel

1. **MAIN POWER (ON/OFF)**
switches the set on or off.
2. **POWER/STANDBY INDICATOR**
illuminates brightly when the set is in standby mode.
dims when the set is switched on.
3. **REMOTE CONTROL SENSOR**
Note : Only use the supplied remote control handset. (When you use others, they'll be not able to function.)
4. **MENU**
selects a menu.
5. **OK**
accepts your selection or displays the current mode.
◀ / ▶ (Volume Up/Down)
adjusts the volume.
adjusts menu settings.
▲ / ▼ (Programme Up/Down)
selects a programme or a menu item.
switches the set on from standby.
6. **AUDIO/VIDEO IN SOCKETS (AV2) (option)**
Connect the audio/video out sockets of external equipment to these sockets.
7. **HEADPHONE SOCKET (option)**
Connect the headphone plug to this socket.

Note : Shown is a simplified representation of front or side panel. Here shown may be somewhat different from your set.

SPECIFICATIONS

Note : Specification and others are subject to change without notice for improvement.

■ Scope

This specification can be applied to all the television related to MC-049C Chassis.

■ Test and Inspection Method

- 1) Capacity : Follow LG electronics TV testing Standard.
- 2) Another Required Standard
 - EMI : Following CE Standard (EN55020, EN55013)
 - Safety : Following CB Standard (EN55013)

■ Requirement for Test

Testing for standard of each par must be followed in below condition.

- 1) Temperature : $20 \pm 5^{\circ}\text{C}$
(But, CST must be tested $40 \pm 5^{\circ}\text{C}$. Humidity : 50%)
- 2) Relative Humidity : $65 \pm 10\%$
- 3) Power : Standard input Voltage (110-240V~, 50/60Hz)
- 4) Measurement must be performed after heat-run more than 20min.
- 5) Adjusting Standard for this chassis is followed a special standard.

■ General Specification

No	Item	Specification	Remark
1	Receiving System	1) PAL/SECAM BG 2) PAL/SECAM DK 3) PAL I/I 4) NTSC M 5) SECAM-L/L' 6) NTSC 4.43(AV)	For EU/ For Non EU
2	Receiving Channel	1) VHF : E2 ~ E12 UHF : E21 ~ E69 CATV : S1 ~ S20 HYPER : S21 ~ S41 2) L/L' : B,C,D	For EU/ For Non EU
		3) VHF : 02 ~ 13 UHF : 14~ 69 CATV : 02 ~ 71	NTSC-M (Multi - model)
3	Input Voltage	110-240V~, 50/60Hz 240V~, 50Hz	Non EU EU
4	Market	EU,CIS, China, Asia, Africa	Initial Model -> for EU
5	Screen Size	F 21"	SUPER SLIM
6	Tuning System	FVS 100Program	
7	Operating Environment	1) Temp. : 0 ~ 45 deg 2) Humidity: 85% under	200 PR. (OPTION)
8	Storage Environment	1) Temp. : -20 ~ 60 deg 2) Humidity: 85% under	

ADJUSTMENT INSTRUCTIONS

1. Application Object

These instructions are applied to all of the color TV, MC-049C.

2. Notes

- (1) Because this is not a hot chassis, it is not necessary to use an isolation transformer. However, the use of isolation transformer will help protect test instrument.
- (2) Adjustment must be done in the correct order. But the adjustment can be changed by consideration of mass production.
- (3) The adjustment must be performed in the circumstance of $25\pm 5^{\circ}\text{C}$ of temperature and $65\pm 10\%$ of relative humidity if there is no specific designation.
- (4) The input AC voltage of the receiver must keep rating voltage in adjusting.
- (5) The receiver must be operated for about 15 minutes prior to the adjustment.

3. Focus adjustment

3.1. Preliminary steps

Tune the TV set to receive a digital pattern.
(SVC mode: Automatically mode change the STANDARD mode)

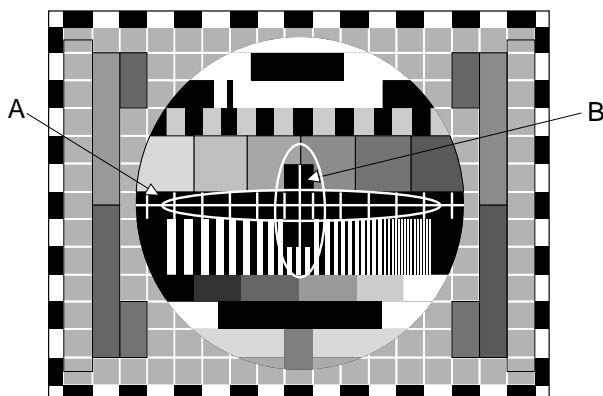

<Fig 1. PAL Digital Pattern(EU05CH)>

3.2. Adjustment Method

1) Single Focus CPT

Adjust the upper Focus volume of FBT for the best focus of horizontal line A, vertical line B.

4. Screen voltage adjustment

- (1) Receive the PAL or SECAM(NTSC) signal into RF mode regardless of channel.
- (2) If you press the "ADJ" button in LINE SVC mode (IN-START button), the LINE SVC mode changes to screen adjustment mode.
- (3) Adjust the screen volume of FBT jack, When width line is seen turn the FBT screen volume at the position of disappearance it.
- (4) Press the TV/AV button to exit SVC mode.

5. White balance adjustment

NOTE : When adjusting white balance automatically, connect the adjustment JIG in SVC mode. (When pressing ,MUTE button on remote control, it changes to CPU OFF MODE and screen displays "AUTO".)

- (1) Receive 100% white pattern.
- (2) Adjust LOW Light status(4.5FL) of CUT R, CUT B at CUT G:80.
- (3) Adjust HIGH Light status(35FL) of WDR R, WDR B at WDR G:400.
- (4) Repeat above step (2) and (3) for the best condition each status of High Light and Low Light.

<Table 1> White Balance Color analyzer

Menu	EU	N-EU
X	288	266
Y	295	273
Color Temperature	9000°K	13000°K

<Table 2> White Balance Initial Data

Menu	Menu	Range	DATA
LOW LIGHT	CUT R	0 ~ 511	80
	CUT G	0 ~ 511	80
	CUT B	0 ~ 511	80
HIGH LIGHT	WDR R	0 ~ 511	400
	WDR G	0 ~ 511	400
	WDR B	0 ~ 511	400

<Table 3> White Balance Initial Data

1. IC

	Name	Maker	Algorithm		
VCD IC	VCT49xyi	Micronas	0	A	0
EP_ROM	24C16	ST, ATMEL			

2. White balance IIC Parameter

Program	TWBeng_v049	Program	TWBeng_v049	Speed	Delay
Vcd Slave	BCF0	Eprom_Slave	AC	1	30

	R_Amp	R_Cut	B_Amp	B_Cut
Program	TWBeng_v049	TWBeng_v049	TWBeng_v049	TWBeng_v049
Sub Add	1C8	1C3	1CA	1C5
Start Bit	12	12	12	12
Stop Bit	4	4	4	4
Offset	0	0	0	0
Polarity	1	1	1	1
EP_Rom_S	9091	8A8B	9495	8E8F

Speed/ Plus	1	1	1	1

<CAUTION> W/B Program "Twbeng_v049"
 - W/B adjustment after Cutoff
 : Instart -> adj. -> mute(cutoff)-> tv/av(wb)
 Release key is EXIT key
 - W/B adjustment
 : Instart -> mute(cpuoff)
 Release key is TV/AV key

6.Sub-Brightness adjustment

6-1. Preparation for Adjustment

- (1) Tune the TV set to receive an Digital pattern(EU05CH).
- (2) Deflection setting data adjustment is operate by SVC communicator.
- (3) Enter the Sub-Brightness mode by selection SERVICE1 on SERVICE MENU after pressing LINE SVC MODE(IN-START KEY).
- (4) Use the CH ▲,▼ key to select adjustment item.
- (5) Use the VOL ◀,▶ key to increase/decrease data.

6.2 Adjustment

After authorizing a PAL signal, adjust up to the point which divide one or two volume in Gray Scale of the bottom screen.

7.Deflection setting Data Adjustment

7.1 Adjustment preparation

- (1) Tune the TV set to receive an Digital pattern(EU05CH).
- (2) Deflection setting data adjustment is operate by SVC communicator.
- (3) Enter the deflection adjustment mode by selection SERVICE1 on SERVICE MENU after pressing LINE SVC MODE(IN-START KEY).
- (4) Use the CH ▲,▼ key to select adjustment item.
- (5) Use the VOL ◀,▶ key to increase/decrease data.

7.2 Adjustment

- (1) After authorizing a PAL signal, adjust to N50ch .
- (2) After adjusting a PAL signal, authorize and notify to NTSC(US13ch), adjust NTSC if necessary.

* After finishing deflection adjustment,press the ENTER button to enter or exit in SVC mode.

< Term explanation >

- (1) VL(Vertical Linearity) adjustment:
Adjust the top & bottom size of inner circle to be equal.
- (2) VA (Vertical Amplitude) adjustment:
Adjust so that the circle of a digital circle pattern should be located interval of 6~7mm from the effective screen of the CPT.
- (3) SC (S correction) adjustment:
Adjust so that all distance between each lattice width of top/center/bottom are to be the same.

* Setting the CPT Default(Initial data) value like that, because it is decide by CPT DY value

- (4) VS (Vertical Shift) adjustment:
Adjust so that the geometric vertical center line is in accord with vertical center line of CPT.
- (5) HS(Horizontal Shift) adjustment:
Adjust so that the geometric horizontal center line is in accord with horizontal center line of CPT.
- (6) EW(Hor. Width) adjustment
Adjust until the outmost left and right lattice of received pattern is accord with 25% of other lattice width.
- (7) ET(Trapezoidal) adjustment
Adjust to make the length of top horizontal line same with it of the bottom horizontal line.
- (8) EP(Pin Cushion) adjustment
Adjust so that middle portion of the outermost left and right vertical line look like parallel with vertical lines of the CPT.
- (9) ANGLE adjustment
When you adjust the angle, adjust correctly raster of left/right screen.
- (10) Bow adjustment
After finished EP adjustment, adjust until symmetrize upper and lower corner of the screen.
- (11) UPCOR/LOCOR(Upper/Lower Corner) adjustment
After finished EP adjustment,adjust vertical line of left-top, right-top, left-bottom, right-bottom of screen to the best straight line.

<Table 4> Initial value of deflection setting

Menu	Variable range	N50Hz(PAL) FLAT 21"	N60Hz(NTSC) FLAT 21"
VS	-512~511	150	140
VA	-512~511	-12	-12
VL	-512~511	140	140
SC	-512~511	6	6
HS	32~2047	100	123

8. How to inspect condition of a transmission and reception in FM TRANSMITTER MODEL.

- FM TRANSMITTER's efficiency inspections is executed to a finished in a final inspection phase.
- FM TRANSMITTER is a function which receives voice-signal by an exclusive remote control and earphone, transmits a FM through transmitter of inner part in MICOM BOADR to TV sound(MONITOR OUTPUT)
- If the received frequency which set up in OSD is being tunned without using an exclusive remote control ,it is available to receive in a general FM receiver.

- (1) Execute in channel generating voice-signal.
- (2) Select a transmitted frequency in MENU OSD.
MENU -> SOUND -> TRANSMITTER
-> Select frequency(87.7MHZ)
- (3) A received frequency in an exclusive remote control or received FM Radio is tuned by 87.7MHz which is same as frequency in OSD.
- (4) Check out whether a signal generating to MAIN SPEAKER generates in earphone or receiver or not.
- (5) There is no alternation and setting of adjusted DATA in the process of inspecting FM TX.

9.OPTION Adjustment

9-1. Preparation for Adjustment

- 1) This option adjustment decides function in accordance with model. Press IN-START button on SVC communicator, then adjust the option at OPTION1 mode.
- 2) Mark the option adjustment data like [111,111,111,111] in BOM.

9-2. Adjustment Method

OPTION data input

- 1) Function : YES, No function : NO
- 2) Select each OPTION function by the CH Up/Down button and then set up each OPTION(yes or no) by the VOL Up/Down button.

9-3. OPTION 1

Option	Code	Function
INCH	0	21A
	1	21B
	2	21C
	3	29F/25F
	4	28WF/32WF
	5	28N
	6	34F
SYS	7	29N/25N
	0	BG/I/DK
	1	BG/I/DK/L
	2	BG/I/DK/M
SOUND	3	BG/L
	0	RF STEREO
	1	AV STEREO
	2	MONO
CH+AU	3	MONO DUAL
	0	No using
	1	Using

9-4. OPTION2

Option	Code	Function
AV2	0	Without AV2
	1	With AV2
DVD	0	Without DVD
	1	With DVD
SCART1	0	Without SCART
	1	With SCART
GAME	0	Without GAME function
	1	With GAME function
EYE	0	Without EYE
	1	With EYE
TX	0	With PIP
	1	Without PIP
KEY	0	6,8 KEY
	1	4 KEY
DEGAU	0	Without DEGAU
	1	Whit DEGAU

9-5. OPTION3

Option	Code	Function
TEXT	0	Without TEXT (200PR)
	1	With TEXT (100PR)
TOP	0	FLOP
	1	TOP
ACMS	0	Without ACMS
	1	With ACMS
I 2 SV	0	Without I 2 SV
	1	With I 2 SV
VOL	0	VOL 0
	1	VOL 1
TSEAR	0	Without TURBO SEARCH
	1	With TURBO SEARCH
T P-S	0	Without TURBO PICTURE/ SOUND
	1	With TURBO PICTURE/ SOUND
HDEV	0	Without HDEV
	1	With HDEV

9-6. OPTION4

Option	Code	Function
OSD L	0	ENG ONLY
	1	EU-5EA
	2	EU ETC
	3	GREECE
	4	EU-ALL
	5	FARSI
	6	ARAB URDU
	7	E+HINDI
	8	E+I+M+V
	9	E+THAI
	10	E+CHINA
TXT L	0	WEST EU
	1	EAST EU1
	2	TURKEY EU
	3	EAST EU2
	4	CYRILLIC1
	5	CYRILLIC2
	6	CYRILLIC3
	7	TURK GRE1
	8	TURK GRE2
	9	TURK GRE3
	10	ARAB FRA
	11	ARAB ENG
	12	ARAB HEB1
	13	ARAB HEB2
	14	FARS ENG
	15	FARS FA
	16	FARS ALL
	17	AUTO
HOTEL	0	WITHOUT HDEV
	1	WITH HDEV
MAX V	0~	SETTING VOL MAX
	100	

9-7. OPTION5 Function

Option	Code	Function
LNA	0	Without LAN
	1	With LAN
A2_ST	0	Without A2_ST
	1	With A2_ST
ECO	0	Without SCART
	1	With SCART
TILT	0	Without TILT
	1	With TILT
BOOST	0	Without BOOST
	1	With BOOST
2SCRT	0	With 2SCRT
	1	Without 2SCRT
CHINA	0	Without CHINA
	1	With CHINA
SSLIM	0	Without SSLIM CPT
	1	Whit SSLIM CPT

TROUBLE SHOOTING

RF- STEREO MODEL

PICTURE O.K / NO SOUND

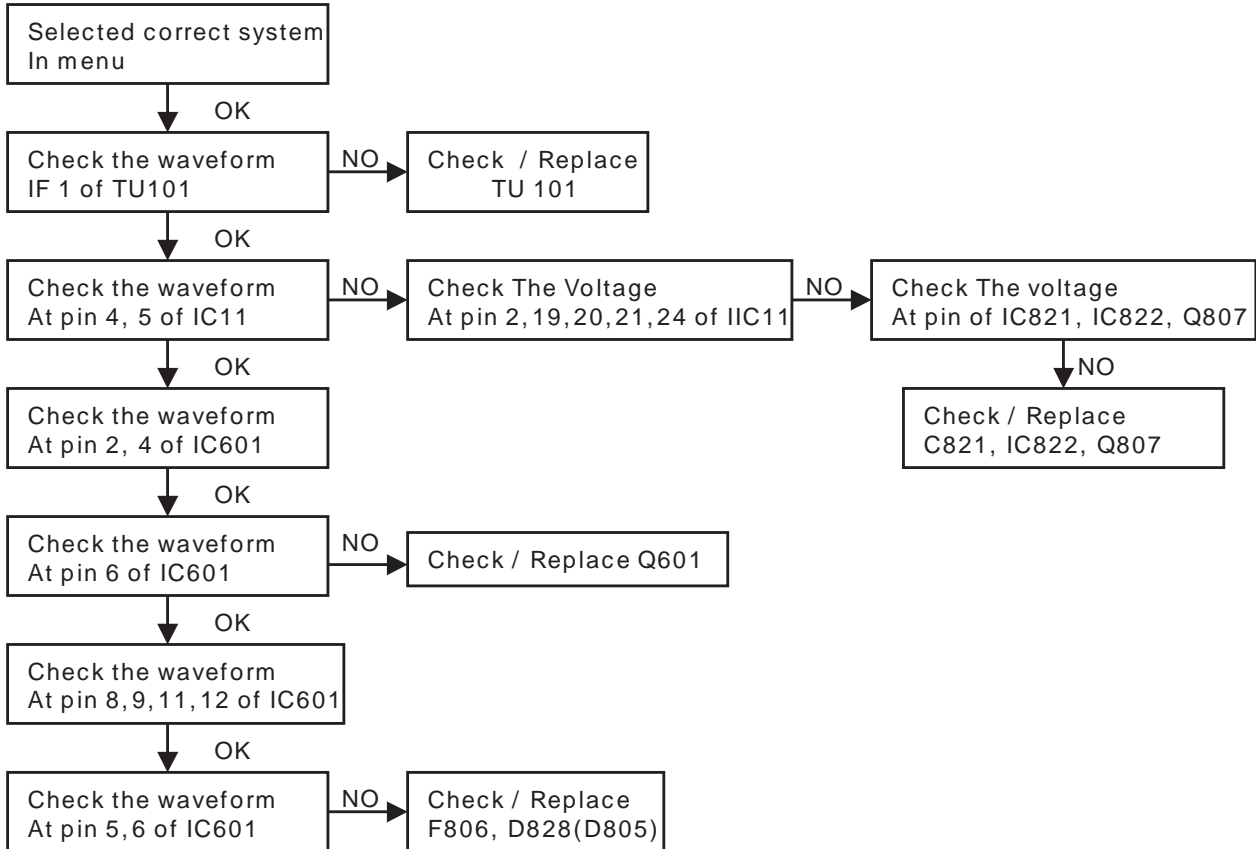

No Raster / Sound OK (1/2)

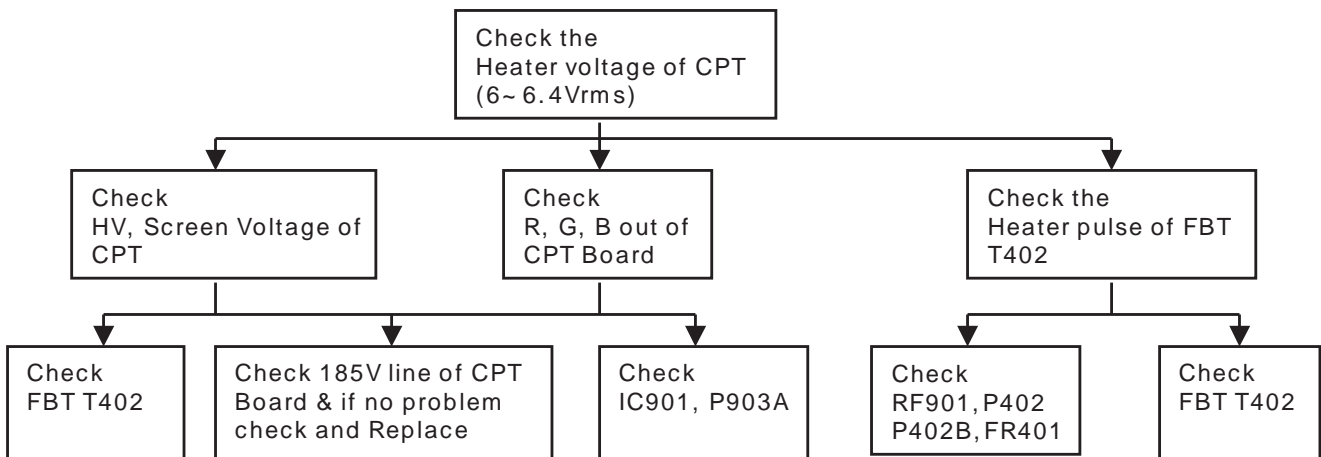

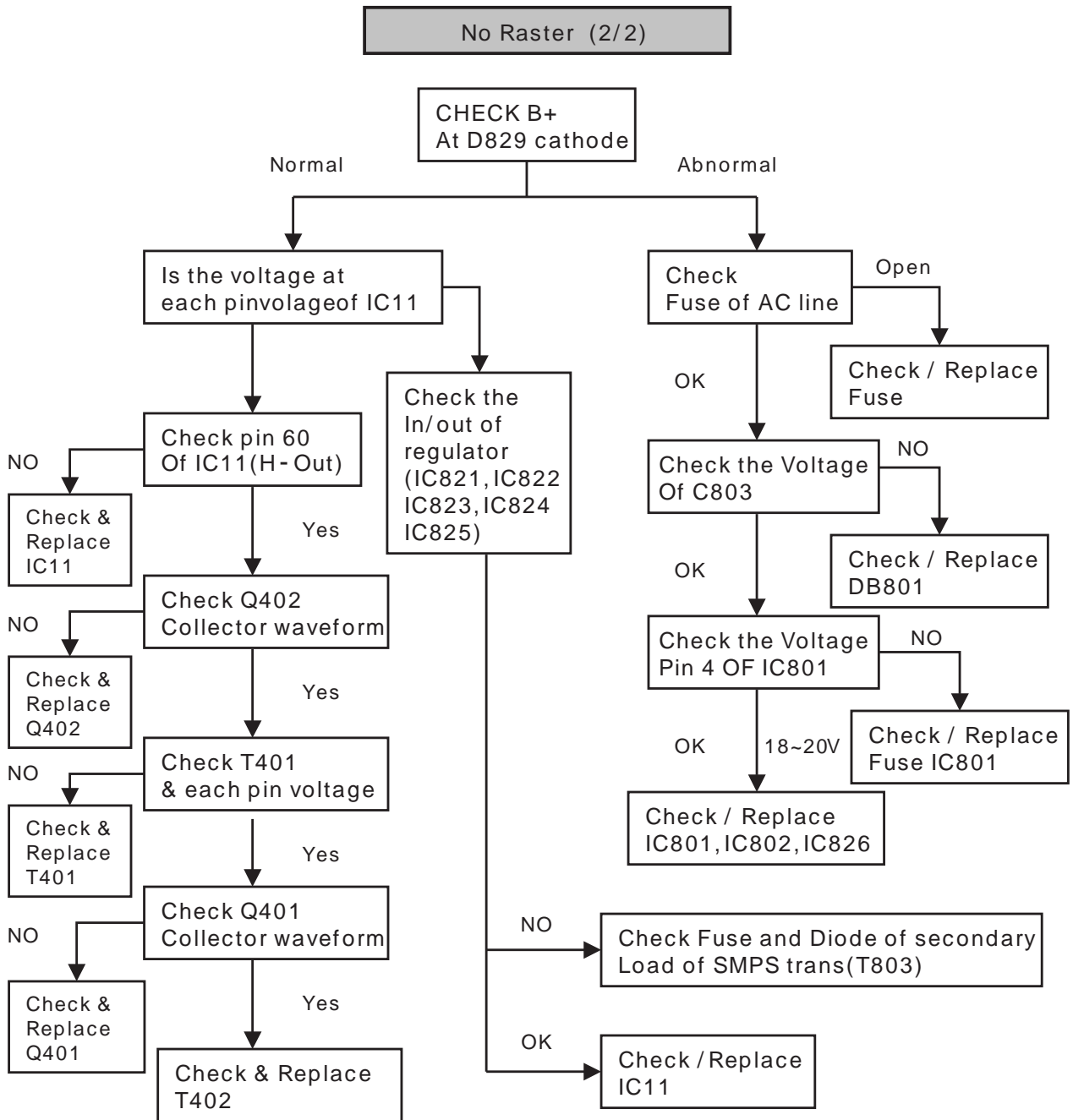

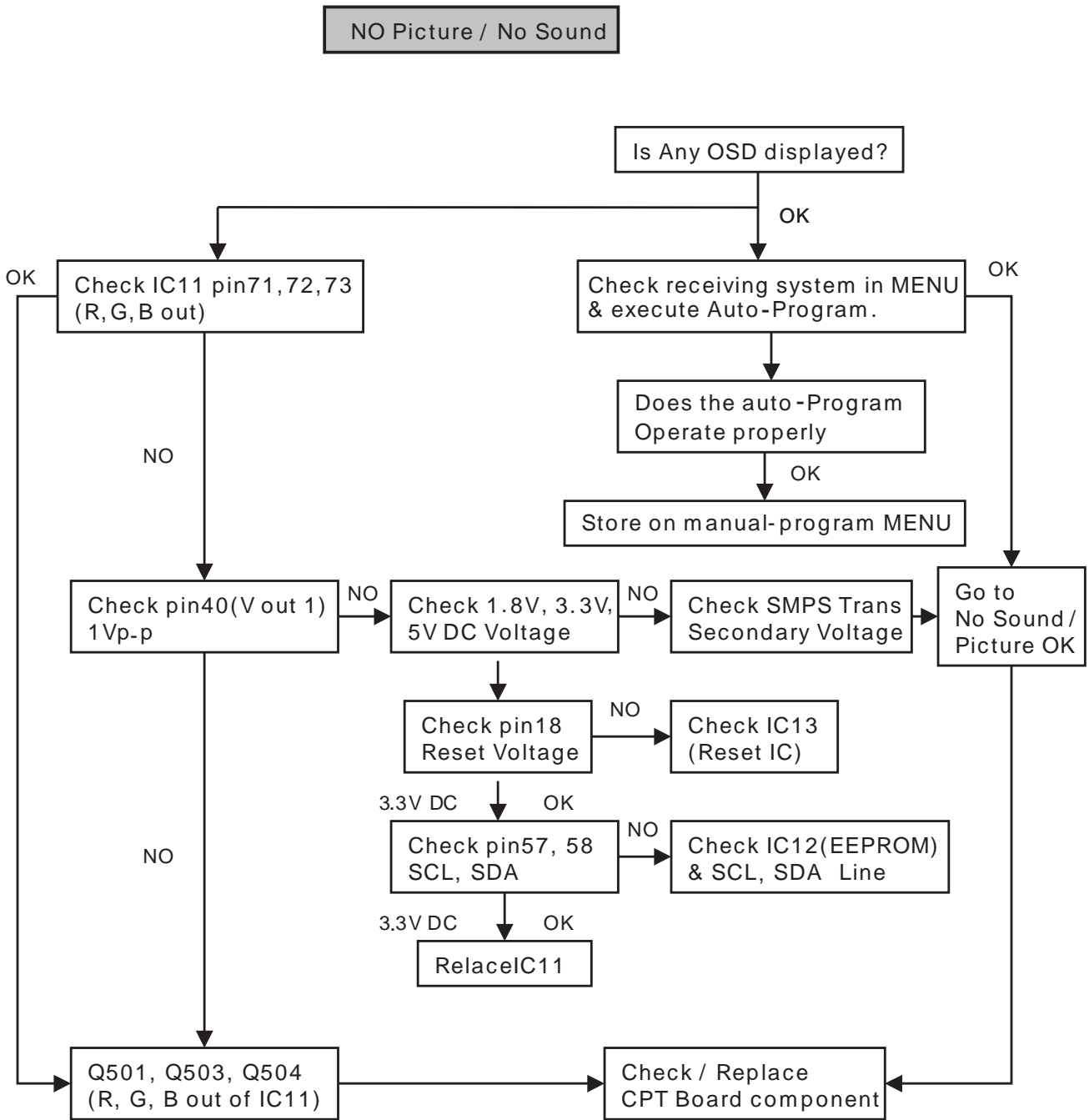

AV STERRO / MONO MODEL

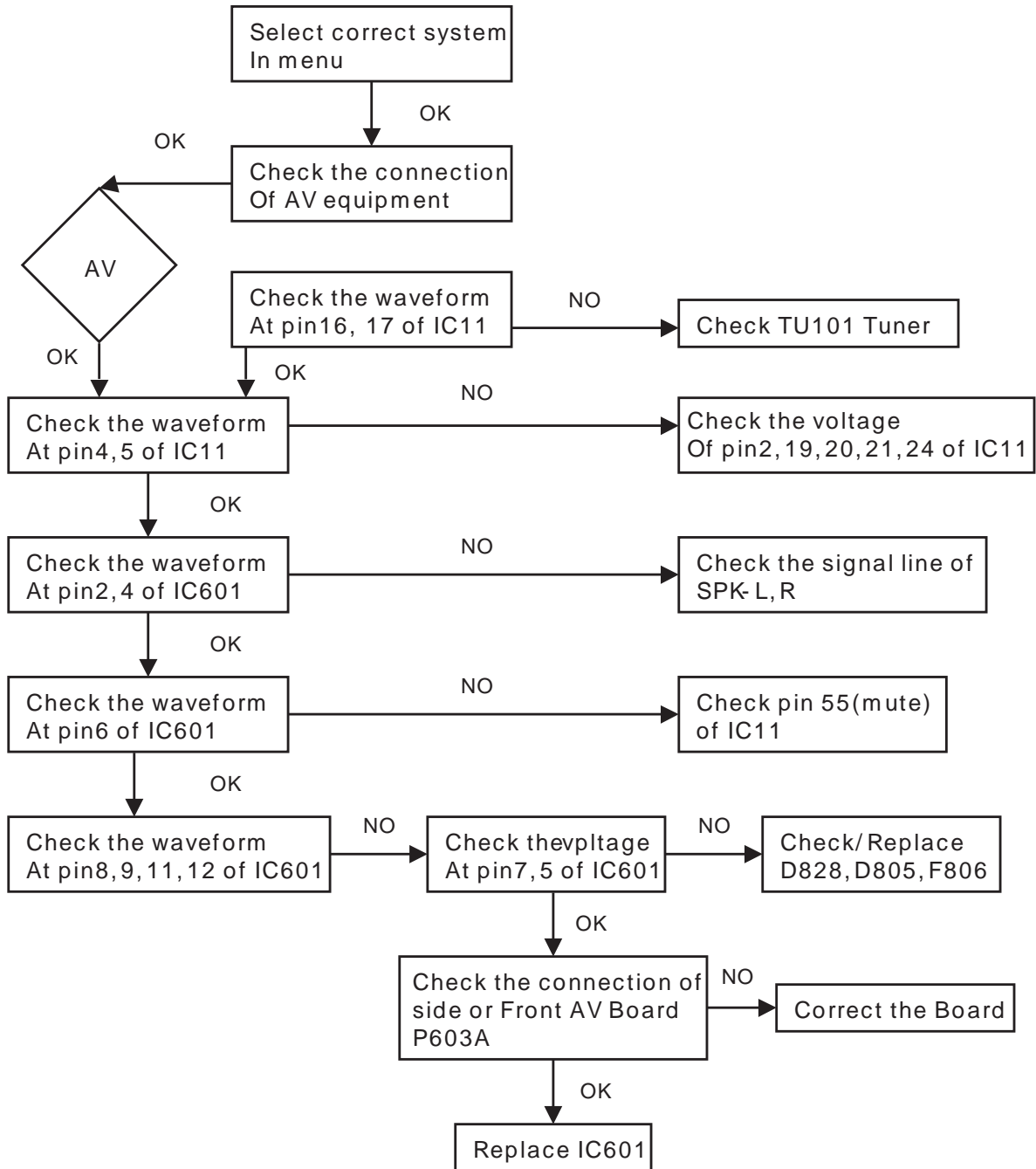

PRINTED CIRCUIT BOARD

MAIN

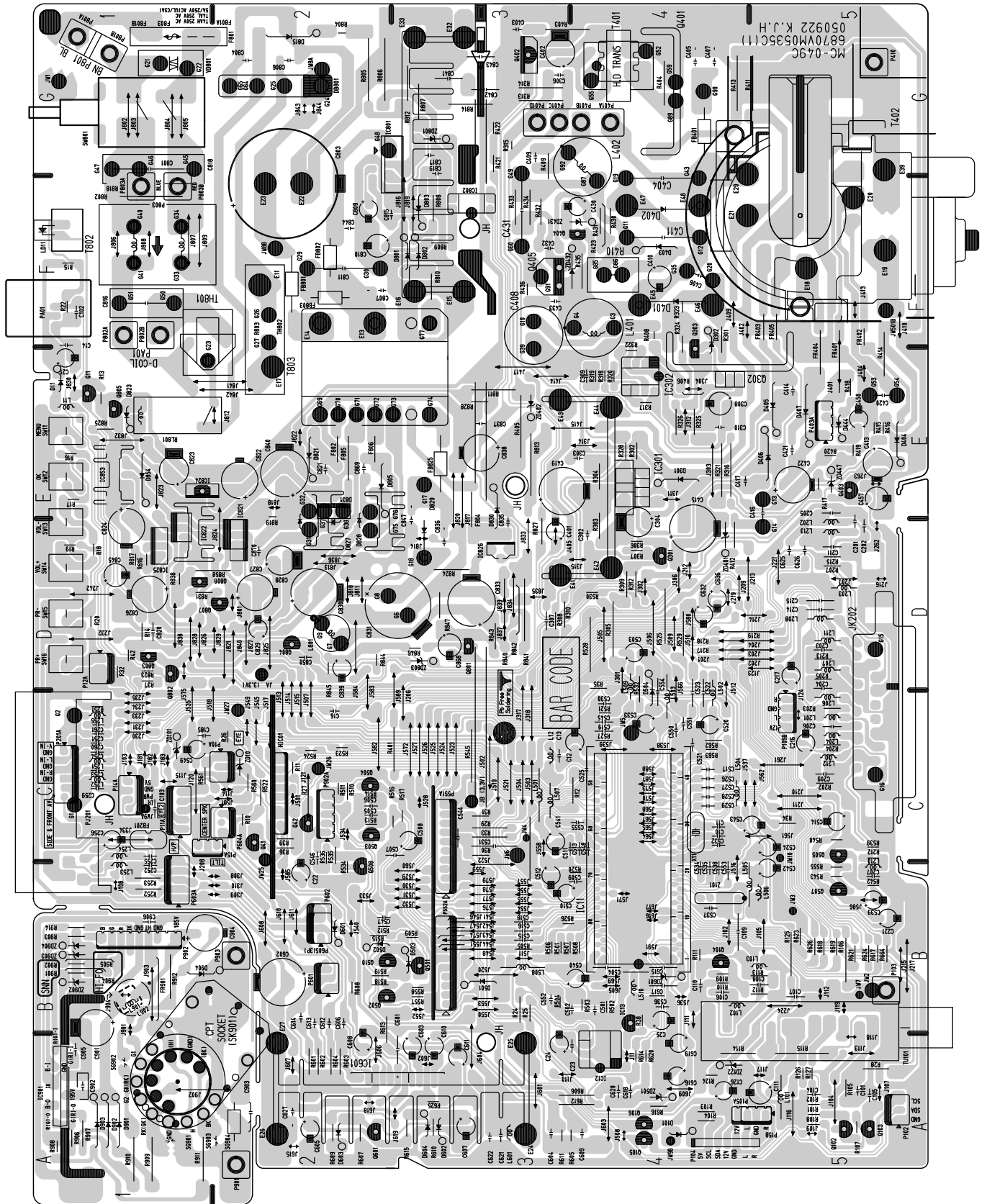

BLOCK DIAGRAM

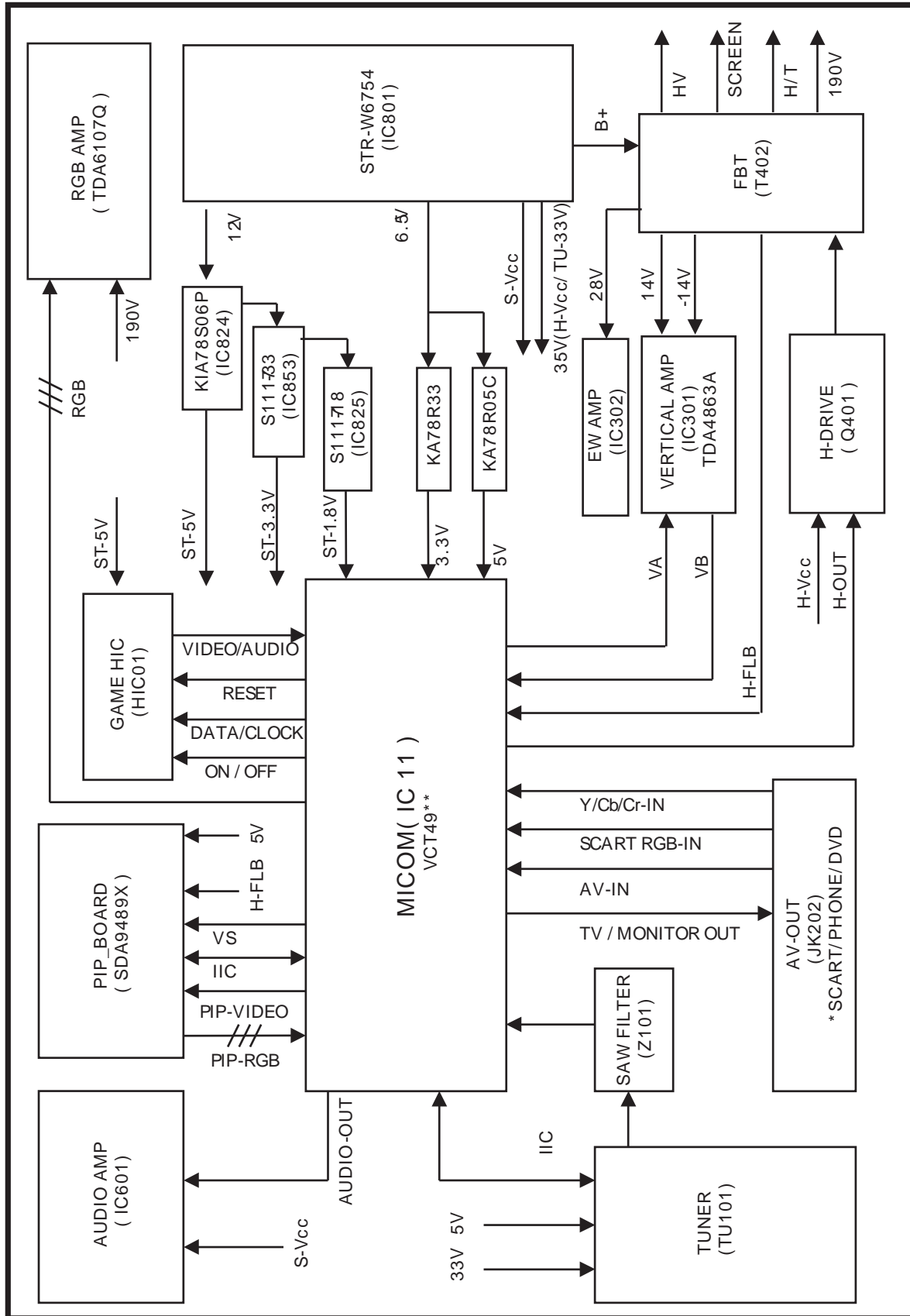

MEMO

EXPLODED VIEW

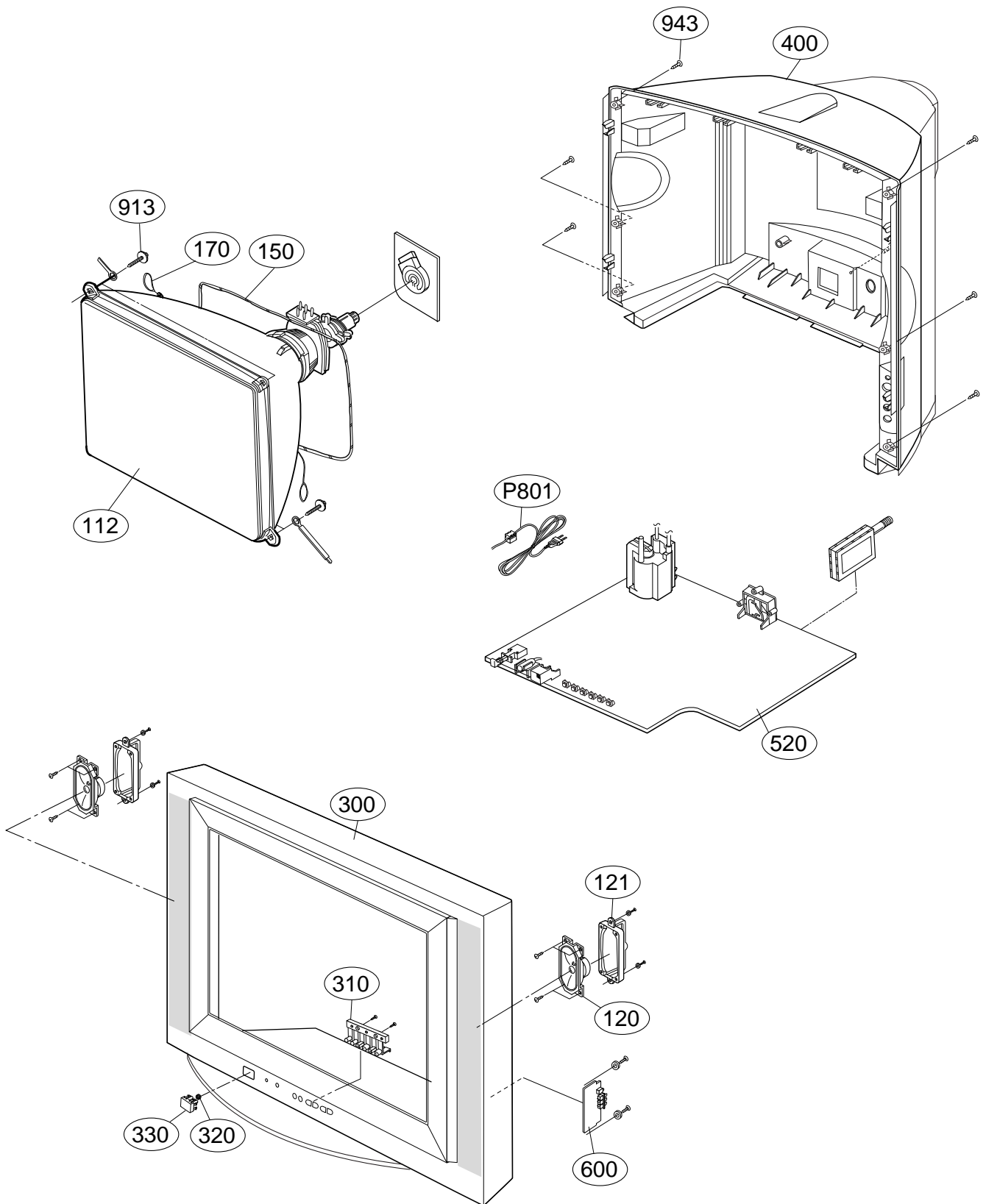

EXPLODED VIEW PARTS LIST

The components identified by mark Δ is critical for safety.
Replace only with part number specified.

LOCA. No.	PART No.	DESCRIPTIONS
Δ 112	6335921002B	CPT ASSEMBLY, A51ERS420X N N(+0.40G) 0G SUPER SLIM, ITC
120	6400VA0001A	SPEAKER,FULLRANGE KK BUKDOO 8 OHM 5/12W 82 DB 110*50
121	4810V01183A	BRACKET, SPEAKER RP-21FX40 SC023A ABS LGERS
Δ 150	6140VC2007N	COIL,DEGAUSSING 1UEW 0.60PIE 44TS 2500MM 11OHM 21INCH SUPER SLIM
Δ 170	170-A01D	CPT EARTH(19")
300	3091V00866D	CABINET ASSEMBLY, 21FS2RLX-TC NO BRAND MC049C SUPER SLIM
310	5020V01127A	BUTTON. CONTROL 21FS2R ABS, HF-380 6KEY SUPERSLIM"
320	320-062H	SPRING, COIL
330	5020V01126A	BUTTON, POWER 21FS2R ABS, HF-380 1KEY SUPERSLIM"
400	3809V00621H	BACK COVER ASSEMBLY, 21FS2RLX-ZC 1PHONE SUPER SLIM MC049C
520	6871VMMH55J	PWB(PCB) ASSEMBLY,MAIN M.I MC049C 21FS2RLX-ZC NUPLLEP SY-MA.CKD
600	6871VSMR18D	PWB(PCB) ASSEMBLY,SUB M.I MC049C (21FS2) 21FS2 SIDE-AV M/I
913	332-057B	SCREW,DRAWING ASSY,HEXAGON HEAD
943	1PTF0403116	SCREW TAP TITE(P),TRUSS HEAD + D4.0 L16.0 MSWR3/FZB
Δ P801	6410VEH001E	POWER CORD, 174-009Q LGESY LOCAL VDE/SEMKO 2410MM 300 BLACK

REPLACEMENT PARTS LIST

For Capacitor & Resistors, the characters at 2nd and 3rd digit in the P/No. means as follows;	CC, CX, CK, CN : Ceramic CQ : Polyester CE : Electrolytic	RD : Carbon Film RS : Metal Oxide Film RN : Metal Film RF : Fusible
---	---	--

LOCA. NO	PART NO	DESCRIPTION
IC		
IC12	OIMMR00010A	24LC16B-I/PG(LEAD FREE) MICRO
IC13	OIFA752700A	KA75270Z 3 TP RE-SET IC MC-007
IC301	OIPMGPH002A	TDA4863A 7P SOT524-1 ST VERTICAL OUTPUT
IC302	OIKE455800E	KIA4558 8DIP DUAL OP AMP -
IC601	OIPMGSA024C	LA42152LG-E SANYO SIP 12P ST 15W
IC801	OIPMGSK016B	STR-W6754 SANKEN 7PIN T0220F ST
IC802	OILI817000G	LTV817M-VB 4P,DIP BK PHOTO COUPLER
IC821	OIMCRKE019A	KIA78R33API KEC 4P TO220 ST 3.3V 1A
IC822	OIMCRKE018A	KIA78R05API KEC 4P TO220 ST 5V 1A
IC824	OIMCRKE020A	KIA78S06P KEC 3P TO-92 TP 6V 0.15A
IC825	OIMCRAU003A	S1117-18PIC 3P TO220F ST 1.8V 1A
IC826	OISK110000A	SE110N(LF12) 3P 110V ERROR AMP -
IC853	OIMCRAU004A	S1117-33PIC 3P TO220F ST 3.3V 1A
IC901	OIPH610700B	TDA6107JF/N3 9P ST RGB AMP
TRANSISTOR		
Q104	OTR319709AB	KTC3197 TP KEC TO92 NPN
Q11	OTR126609AA	KTA1266-Y(KTA1015) TP KEC TO92 PNP
Q301	OTR198009BA	2SA1980Y TP AUK
Q302	OTR205900AB	KTD2059-Y TO-220IS BK KEC
Q303	OTR127409AB	KTA1274-Y TO-92L TP KEC
Q401	OTRSA10001C	2SD2689LS SANYO ST TO220F 1500V 10A
Q402	OTR233109AA	KSC2331-Y TP SAMSUNG TO-92L -
Q404	OTR322800AB	KTC3228-Y(KTC2383), BK KEC
Q405	OTFFC00011A	FQPF11N40C BK TO-220FM 400V 10.5A
Q501	OTR198009BA	2SA1980Y TP AUK
Q502	OTR198009BA	2SA1980Y TP AUK
Q503	OTR198009BA	2SA1980Y TP AUK
Q504	OTR198009BA	2SA1980Y TP AUK
Q505	OTR534309AA	2SC5343Y TP AUK
Q507	OTR198009BA	2SA1980Y TP AUK
Q508	OTR534309AA	2SC5343Y TP AUK
Q510	OTR534309AA	2SC5343Y TP AUK
Q601	OTR198009BA	2SA1980Y TP AUK
Q802	OTR534309AA	2SC5343Y TP AUK
Q803	OTR102009AB	KRC102M(KRC1202) KEC TP
Q805	OTR534309AA	2SC5343Y TP AUK
Q807	OTR127409AB	KTA1274-Y TO-92L TP KEC
Q808	OTR102009AB	KRC102M(KRC1202) KEC TP
DIODE		
D301	ODR140059AC	1N4005GP TP DO41 600V 1.0A
D302	ODS141489AB	1N4148 TP GRANDE - 20V -
D401	ODD410000AD	RU4AM(LF-L1) BK SANKEN L-TMD6.5
D402	ODD410000AC	RU4DS,LF-L1 SANKEN SANKEN
D403	ODRTW00164B	RGP15J TP52 DO15 .V 1.5A 50A 250NSEC
D404	ODR060009AA	TVR06J TP DO41 600V 0.6A

LOCA. NO	PART NO	DESCRIPTION
D405	ODRTW00164B	RGP15J TP52 DO15 .V 1.5A 50A 250NSEC
D406	ODRTW00164B	RGP15J TP52 DO15 .V 1.5A 50A 250NSEC
D407	ODR060009AA	TVR06J TP DO41 600V 0.6A
D501	ODS141489AB	1N4148 TP GRANDE - 20V
D502	ODS141489AB	1N4148 TP GRANDE - 20V
D503	ODS141489AB	1N4148 TP GRANDE - 20V
D504	ODS141489AB	1N4148 TP GRANDE - 20V
D601	ODS141489AB	1N4148 TP GRANDE - 20V
D602	ODS141489AB	1N4148 TP GRANDE - 20V
D603	ODS141489AB	1N4148 TP GRANDE - 20V
D604	ODS141489AB	1N4148 TP GRANDE - 20V
D801	ODD100009AM	EU1ZV(1) TP E/EO-TMD 200V 0.25A
D802	ODR100009FA	EU1DGR TP DO41 200V 1.0A 30A 50NSEC
D803	ODR100009FA	EU1DGR TP DO41 200V 1.0A 30A 50NSEC
D815	ODR060009AA	TVR06J TP DO41 600V 0.6A
D821	ODR060009AA	TVR06J TP DO41 600V 0.6A
D823	ODS141489AB	1N4148 TP GRANDE - 20V -
D827	ODRTW00141A	SFAF504G ST ITO220 200V 5A .A .SEC 10UA
D828	ODRTW00141A	SFAF504G ST ITO220 200V 5A .A .SEC 10UA
D829	ODD300009AC	RU3AMV(1) TP R-TMD 600V 1.5A 50A 0.4US
D830	ODR060009AA	TVR06J TP DO41 600V 0.6A
D854	ODR060009AA	TVR06J TP DO41 600V 0.6A
D901	ODR210009AC	BAV21 TP DO35 200V 0.2A 1A 50SEC 100A
D902	ODR210009AC	BAV21 TP DO35 200V 0.2A 1A 50SEC 100A
D903	ODR210009AC	BAV21 TP DO35 200V 0.2A 1A 50SEC 100A
D904	ODR140049AC	1N4004A T-81 TP DO41 500V 1.0A 30A - 10UA
DB801	ODRTW00131C	TS6P05G ST TSOP-6 600V 6A .A .SEC .A
ZD122	ODZ330009DG	GDZJ33B TP GRANDE DO34 0.5W 33.0V
ZD401	ODZ510009BF	GDZ5.1B TP GRANDE DO34 0.5W 5.1V 0.02A
ZD402	ODZ240009BH	GDZJ24B TP GRANDE DO34 0.5W 24.0V
ZD431	ODZ470009EF	GDZJ4.7B TP DO34 0.5W 4.7V 5MA PF
ZD432	ODZ120009AF	MTZJ12B TP ROHM-K DO34 - 12V 5UA
ZD501	ODZ110009CF	GDZJ11B TP GRANDE DO34 0.5W 11.0V
ZD601	ODZ820009BF	GDZJ8.2B TP GRANDE DO34 0.5W 8.2V
ZD801	ODZ620009AH	MTZJ6.2A TP ROHM-K DO34 0.5W 6.2V 150UA
ZD803	ODZ510009AK	GDZJ5.1B TP GRANDE DO34 0.5W 5.1V
CAPACITOR		
C10	OCX2200K409	22PF D 50V 5% SL TA52
C101	OCQ2721N409	0.0027UF D 100V 5% PE TP5
C103	OCN1040K949	0.1UF D 50V 80%,-20% F(Y5V) TA52
C104	OCN1030F679	10000PF D 16V 20% X5R TA52
C106	OCN1030F679	10000PF D 16V 20% X5R TA52
C107	OCN1030F679	10000PF D 16V 20% X5R TA52
C108	OCN1030F679	10000PF D 16V 20% X5R TA52
C109	OCN1030F679	10000PF D 16V 20% X5R TA52
C11	OCX2200K409	22PF D 50V 5% SL TA52
C110	OCN1030F679	10000PF D 16V 20% X5R TA52
C111	OCE227DD618	220UF STD 10V 20% FL TP 5

For Capacitor & Resistors, the characters at 2nd and 3rd digit in the P/No. means as follows;	CC, CX, CK, CN : Ceramic CQ : Polyester CE : Electrolytic	RD : Carbon Film RS : Metal Oxide Film RN : Metal Film RF : Fusible
--	---	--

LOCA. NO	PART NO	DESCRIPTION	LOCA. NO	PART NO	DESCRIPTION
C12	0CE107DD618	100UF STD 10V 20% FL TP 5	C422	0CE475DR618	4.7UF STD 250V 20% FL TP 5
C1202	0CN1010K519	100PF D 50V 10% B(Y5P) TA52	C430	0CE106BK618	10UF KME TYPE 50V 20% FL TP 5
C1203	0CN1010K519	100PF D 50V 10% B(Y5P) TA52	C431	181-010E	PP 400V 0.12UF J
C1247	0CN2210K519	220PF D 50V 10% B(Y5P) TA52	C432	0CQ1041N509	0.1UF D 100V 10% PE TP5
C1248	0CN2210K519	220PF D 50V 10% B(Y5P) TA52	C433	0CQ1021N509	0.001UF D 100V 10% PE TP5
C1258	0CE107DD618	100UF STD 10V 20% FL TP 5	C501	0CQ3931N509	0.039UF D 100V 10% PE TP5
C1259	0CE107DD618	100UF STD 10V 20% FL TP 5	C502	0CQ3931N509	0.039UF D 100V 10% PE TP5
C126	0CE475DK618	4.7UF STD 50V 20% FL TP 5	C503	0CE475DK618	4.7UF STD 50V 20% FL TP 5
C1260	0CE226DF618	22UF STD 16V 20% FL TP 5	C504	0CN1040K949	0.1UF D 50V 80%,-20% F(Y5V) TA52
C13	0CN1040K949	0.1UF D 50V 80%,-20% F(Y5V) TA52	C505	0CN2710K519	270PF D 50V 10% B(Y5P) TA52
C14	0CN1020K519	1000PF D 50V 10% B(Y5P) TA52	C506	0CN2710K519	270PF D 50V 10% B(Y5P) TA52
C185	0CN1040K949	0.1UF D 50V 80%,-20% F(Y5V) TA52	C507	0CN1040K949	0.1UF D 50V 80%,-20% F(Y5V) TA52
C203	0CN4710K519	470PF D 50V 10% B(Y5P) TA52	C508	0CE107DD618	100UF STD 10V 20% FL TP 5
C204	0CN4710K519	470PF D 50V 10% B(Y5P) TA52	C509	0CN1040K949	0.1UF D 50V 80%,-20% F(Y5V) TA52
C205	0CN1010K519	100PF D 50V 10% B(Y5P) TA52	C510	0CE475DK618	4.7UF STD 50V 20% FL TP 5
C206	0CN4710K519	470PF D 50V 10% B(Y5P) TA52	C511	0CN1040K949	0.1UF D 50V 80%,-20% F(Y5V) TA52
C209	0CN4710K519	470PF D 50V 10% B(Y5P) TA52	C512	0CE107DD618	100UF STD 10V 20% FL TP 5
C21	0CE107DD618	100UF STD 10V 20% FL TP 5	C513	0CN1040K949	0.1UF D 50V 80%,-20% F(Y5V) TA52
C211	0CN1010K519	100PF D 50V 10% B(Y5P) TA52	C514	0CE107DD618	100UF STD 10V 20% FL TP 5
C214	0CN4710K519	470PF D 50V 10% B(Y5P) TA52	C515	0CN1040K949	0.1UF D 50V 80%,-20% F(Y5V) TA52
C215	0CN4710K519	470PF D 50V 10% B(Y5P) TA52	C516	0CN1040K949	0.1UF D 50V 80%,-20% F(Y5V) TA52
C216	0CE226DF618	22UF STD 16V 20% FL TP 5	C517	0CN1040K949	0.1UF D 50V 80%,-20% F(Y5V) TA52
C217	0CE226DF618	22UF STD 16V 20% FL TP 5	C518	0CN1040K949	0.1UF D 50V 80%,-20% F(Y5V) TA52
C221	0CE476DF618	47UF STD 16V 20% FL TP 5	C519	0CN1010K519	100PF D 50V 10% B(Y5P) TA52
C23	0CN1040K949	0.1UF D 50V 80%,-20% F(Y5V) TA52	C520	0CE107DD618	100UF STD 10V 20% FL TP 5
C24	0CE226DD618	22UF STD 10V 20% FL TP 5	C521	0CN1040K949	0.1UF D 50V 80%,-20% F(Y5V) TA52
C25	0CE105DK618	1UF STD 50V 20% FL TP 5	C523	0CN1040K949	0.1UF D 50V 80%,-20% F(Y5V) TA52
C261	0CN4710K519	470PF D 50V 10% B(Y5P) TA52	C524	0CE107DD618	100UF STD 10V 20% FL TP 5
C303	0CQ1041N409	0.1UF D 100V 5% PE TP5	C525	0CN3310K519	330PF D 50V 10% B(Y5P) TA52
C304	0CE107DJ618	100UF STD 35V 20% FL TP 5	C526	0CN1040K949	0.1UF D 50V 80%,-20% F(Y5V) TA52
C306	0CQ3331N509	0.033UF D 100V 10% PE TP5	C527	0CN1040K949	0.1UF D 50V 80%,-20% F(Y5V) TA52
C308	0CE476DK618	47UF STD 50V 20% FL TP 5	C528	0CN1040K949	0.1UF D 50V 80%,-20% F(Y5V) TA52
C309	0CN4710K519	470PF D 50V 10% B(Y5P) TA52	C529	0CN1040K949	0.1UF D 50V 80%,-20% F(Y5V) TA52
C310	0CQ1031N509	0.01UF D 100V 10% PE TP5	C530	0CN1010K519	100PF D 50V 10% B(Y5P) TA52
C402	0CE475DK618	4.7UF STD 50V 20% FL TP 5	C531	0CN1010K519	100PF D 50V 10% B(Y5P) TA52
C403	0CQ1521N509	0.0015UF D 100V 10% PE TP5	C532	0CN1040K949	0.1UF D 50V 80%,-20% F(Y5V) TA52
C404	181-015N	MPP 1600V 0.015UF H	C533	0CE107DD618	100UF STD 10V 20% FL TP 5
C405	181-033R	2KV B 102K TP7.5(TEMP.+85)	C534	0CN1040K949	0.1UF D 50V 80%,-20% F(Y5V) TA52
C406	181-009S	PP 200V 0.027UF K	C535	0CN1040K949	0.1UF D 50V 80%,-20% F(Y5V) TA52
C407	181-033R	2KV B 102K TP7.5(TEMP.+85)	C536	0CN1040K949	0.1UF D 50V 80%,-20% F(Y5V) TA52
C408	0CE685BK652	6.8UF KME TYPE 50V 20% FM7.5 BP(S)	C537	0CN1040K949	0.1UF D 50V 80%,-20% F(Y5V) TA52
C409	0CK2220W515	2200PF D 500V 10% B(Y5P) TR	C538	0CN1040K949	0.1UF D 50V 80%,-20% F(Y5V) TA52
C410	0CE105BR618	1UF KME TYPE 250V 20% FL TP 5	C540	0CE107DD618	100UF STD 10V 20% FL TP 5
C411	181-013Z	MPP 400V 0.30UF J	C541	0CE107DD618	100UF STD 10V 20% FL TP 5
C413	0CE107DJ618	100UF STD 35V 20% FL TP 5	C542	0CE107DD618	100UF STD 10V 20% FL TP 5
C414	0CK2710W515	270PF D 500V 10% B(Y5P) TR	C543	0CE107DD618	100UF STD 10V 20% FL TP 5
C415	0CE108DH618	1000UF STD 25V 20% FL TP 5	C545	0CX2200K409	22PF D 50V 5% SL TA52
C416	181-009R	PP 200V 0.022UF K	C546	0CN1510K519	150PF D 50V 10% B(Y5P) TA52
C417	0CK2710W515	270PF D 500V 10% B(Y5P) TR	C547	0CN2710K519	270PF D 50V 10% B(Y5P) TA52
C419	0CE108DH618	1000UF STD 25V 20% FL TP 5	C548	0CN1040K949	0.1UF D 50V 80%,-20% F(Y5V) TA52
C420	181-009R	PP 200V 0.022UF K	C550	0CN1040K949	0.1UF D 50V 80%,-20% F(Y5V) TA52
C421	0CK2710W515	270PF D 500V 10% B(Y5P) TR	C552	0CQ3331N509	0.033UF D 100V 10% PE TP5

For Capacitor & Resistors, the characters at 2nd and 3rd digit in the P/No. means as follows;	CC, CX, CK, CN : Ceramic	RD : Carbon Film
	CQ : Polyester	RS : Metal Oxide Film
	CE : Electrolytic	RN : Metal Film
		RF : Fusible

LOCA. NO	PART NO	DESCRIPTION
C554	0CN1020K519	1000PF D 50V 10% B(Y5P) TA52
C555	0CX2200K409	22PF D 50V 5% SL TA52
C601	0CN1040K949	0.1UF D 50V 80%,-20% F(Y5V) TA52
C602	0CE108DH618	1000UF STD 25V 20% FL TP 5
C603	0CE475DK618	4.7UF STD 50V 20% FL TP 5
C604	0CQ2231N509	0.022UF D 100V 10% PE TP5
C605	0CE476DF618	47UF STD 16V 20% FL TP 5
C606	181-007C	MPE ECQ-V1H104JL3(TR), 50V 0.1UF
C607	0CE106DF618	10UF STD 16V 20% FL TP 5
C608	0CE106DF618	10UF STD 16V 20% FL TP 5
C609	0CQ2231N509	0.022UF D 100V 10% PE TP5
C610	0CE475DK618	4.7UF STD 50V 20% FL TP 5
C611	0CE476DH618	47UF STD 25V 20% FL TP 5
C612	181-007C	MPE ECQ-V1H104JL3(TR), 50V 0.1UF
C613	181-007C	MPE ECQ-V1H104JL3(TR), 50V 0.1UF
C614	181-007C	MPE ECQ-V1H104JL3(TR), 50V 0.1UF
C615	0CN1040K949	0.1UF D 50V 80%,-20% F(Y5V) TA52
C616	0CE476DD618	47UF STD 10V 20% FL TP 5
C617	0CN1040K949	0.1UF D 50V 80%,-20% F(Y5V) TA52
C618	0CN1010K519	100PF D 50V 10% B(Y5P) TA52
C619	0CE105DK618	1UF STD 50V 20% FL TP 5
C620	0CN1010K519	100PF D 50V 10% B(Y5P) TA52
C625	0CQ5631N409	0.056UF D 100V 5% PE TP5
C626	0CQ5631N409	0.056UF D 100V 5% PE TP5
C627	0CK1030K945	0.01UF D 50V 80%,-20% F(Y5V) TR
C632	0CQ5631N409	0.056UF D 100V 5% PE TP5
C636	0CQ5631N409	0.056UF D 100V 5% PE TP5
C803	181-001E	LUG 120UF 400V 20% T
C804	0CK10201515	1000PF D 1KV 10% B(Y5P) TR
C806	0CK10201515	1000PF D 1KV 10% B(Y5P) TR
C807	181-091P	SL 270PF 1KV 10%,-10% R/TP TP5
C809	0CE105DK618	1UF STD 50V 20% FL TP 5
C810	0CE336DK618	33UF STD 50V 20% FL TP 5
C811	181-011B	0.001UF D 1.6KV J M/PP NI FM20
C815	0CK8210K515	820PF D 50V 10% B(Y5P) TR
C816	0CQZVBK002A	A.C 275V 0.1UF M (S=15)
C817	0CK1040K945	0.1UF D 50V 80%,-20% F(Y5V) TR
C818	0CQZVBK002C	A.C 275V 0.22UF K (S=22.5)
C819	0CK1520K515	1500PF D 50V 10% B(Y5P) TR
C820	0CN1040K949	0.1UF D 50V 80%,-20% F(Y5V) TA52
C821	0CK4710W515	470PF D 500V 10% B(Y5P) TR
C822	0CE477BH618	470UF KME TYPE 25V 20% FL TP 5
C823	0CE477DD618	470UF STD 10V 20% FL TP 5
C824	0CE108DD618	1000UF STD 10V 20% FL TP 5
C826	0CE108DD618	1000UF STD 10V 20% FL TP 5
C827	0CE108DD618	1000UF STD 10V 20% FL TP 5
C828	0CE477BF618	470UF KME TYPE 16V 20% FL TP 5
C829	0CE335CK636	3.3UF SHL,SD 50V 20% FM5 BP(D) TP
C830	0CE108DH618	1000UF STD 25V 20% FL TP 5
C831	0CE227DP61A	220UF STD 160V 20% FL TP 7.5
C833	0CE107CP618	100UF SHL,SD 160V 20% FL TP 5
C835	0CK4710W515	470PF D 500V 10% B(Y5P) TR

LOCA. NO	PART NO	DESCRIPTION
C836	181-091X	R 560PF 2KV 10%,-10% R/TP TP7.5
C837	0CQ4731N509	0.047UF D 100V 10% PE TP5
C838	0CE227DK618	220UF STD 50V 20% FL TP 5
C840	0CE228BF618	2200UF KME TYPE 16V 20% FL TP 5
C843	181-120K	2200PF 4KV M E FMTW LEAD 4.5
C845	0CE107DD618	100UF STD 10V 20% FL TP 5
C870	181-091P	SL 270PF 1KV 10%,-10% R/TP TP5
C901	0CE475DR618	4.7UF STD 250V 20% FL TP 5
C902	0CH3104P56C	0.1UF 630V 10% X7R 4532 R/TP
C903	181-033S	2KV B 122K TP7.5
C904	0CE475DR618	4.7UF STD 250V 20% FL TP 5
C908	0CH3104P56C	0.1UF 630V 10% X7R 4532 R/TP
COIL & INDUCTOR		
J210	0LA0102K119	INDUCTOR,AXIAL LEAD 10UH 10% A 2.3 X 3.4
J840	0LA0102K119	INDUCTOR,AXIAL LEAD 10UH 10% A 2.3 X 3.4
L101	0LA0102K139	INDUCTOR,AXIAL LEAD 10UH 10% A 4.0 X 10.5
L103	0LA0101K119	INDUCTOR,AXIAL LEAD 1UH 10% A 2.3 X 3.4
L11	0LA0102K119	INDUCTOR,AXIAL LEAD 10UH 10% A 2.3 X 3.4
L12	0LA0101K119	INDUCTOR,AXIAL LEAD 1UH 10% A 2.3 X 3.4
L1202	0LA0102K119	INDUCTOR,AXIAL LEAD 10UH 10% A 2.3 X 3.4
L1203	0LA0102K119	INDUCTOR,AXIAL LEAD 10UH 10% A 2.3 X 3.4
L1253	0LA0102K119	INDUCTOR,AXIAL LEAD 10UH 10% A 2.3 X 3.4
L1254	0LA0102K119	INDUCTOR,AXIAL LEAD 10UH 10% A 2.3 X 3.4
L201	0LA0102K119	INDUCTOR,AXIAL LEAD 10UH 10% A 2.3 X 3.4
L204	0LA0102K119	INDUCTOR,AXIAL LEAD 10UH 10% A 2.3 X 3.4
L206	0LA0102K119	INDUCTOR,AXIAL LEAD 10UH 10% A 2.3 X 3.4
L207	0LA0102K119	INDUCTOR,AXIAL LEAD 10UH 10% A 2.3 X 3.4
L208	0LA0102K119	INDUCTOR,AXIAL LEAD 10UH 10% A 2.3 X 3.4
L211	0LA0102K119	INDUCTOR,AXIAL LEAD 10UH 10% A 2.3 X 3.4
L213	0LA0102K119	INDUCTOR,AXIAL LEAD 10UH 10% A 2.3 X 3.4
L401	150-717J	COIL,CHOKECHOKE 560UH (E/W)
L402	6140VY0020C	COIL,LINEARITYJS-E016 24.0UH 25% 1UEW
L501	0LA0102K119	INDUCTOR,AXIAL LEAD 10UH 10% A 2.3 X 3.4
L502	0LA0102K119	INDUCTOR,AXIAL LEAD 10UH 10% A 2.3 X 3.4
L504	0LA0101K119	INDUCTOR,AXIAL LEAD 1UH 10% A 2.3 X 3.4
L505	0LA0102K119	INDUCTOR,AXIAL LEAD 10UH 10% A 2.3 X 3.4
L506	0LA0102K119	INDUCTOR,AXIAL LEAD 10UH 10% A 2.3 X 3.4
L507	0LA0101K119	INDUCTOR,AXIAL LEAD 1UH 10% A 2.3 X 3.4
L508	0LA0101K119	INDUCTOR,AXIAL LEAD 1UH 10% A 2.3 X 3.4
L801	150-C02F	COIL,CHOKE82UH PHY TURN
T401	151-C02F	TRANSFORMER,H-DRIVE,EI-19,BULK
T803	6170VMCA13V	TRANSFORMER,SMPS[COIL] EER4215 300UH
CONNECTOR		
C1	6631V25014H	3P 2.5MM 800MM R-H UL1007 AWG26
C2	6631V80008J	4P 8.0MM 550MM H-H UL1007AWG18
P102	366-932B	IL-G-03P LGC 2.5MM S/T STICK
P1205	387-A06H	6P 2.5MM 450MM H-B UL1007AWG26
P1206	387-A05H	5P 2.5MM 450MM H-B UL1007AWG26
P201A	366-932E	GIL-G-06P LGC 6PIN 2.54MM STICK
P401	366-043K	35929-0410 MOLEX 4PIN 8.0-6.0MM

For Capacitor & Resistors, the characters at 2nd and 3rd digit in the P/No. means as follows;	CC, CX, CK, CN : Ceramic CQ : Polyester CE : Electrolytic	RD : Carbon Film RS : Metal Oxide Film RN : Metal Film RF : Fusible
--	---	--

LOCA. NO	PART NO	DESCRIPTION
P601	366-932B	IL-G-03P LGC 2.5MM S/T STICK
P602	366-932C	IL-G-04P LGC 2.5MM S/T STICK
P603A	366-932D	GIL-G-05P LGC 5PIN 2.54MM STICK
P801A	366-009D	2.36PAI 1P . K/M AUTO
P801B	366-009D	2.36PAI 1P . K/M AUTO
P802A	366-009D	2.36PAI 1P . K/M AUTO
P802B	366-009D	2.36PAI 1P . K/M AUTO
P902	387-603E	9P 2.5MM 430MM B-B UL1007AWG26
P903	366-009D	2.36PAI 1P . K/M AUTO

RESISTOR

F802	0RP0050H709	0.05 OHM 1/2 W 10% TA52
F804	0RP0050H709	0.05 OHM 1/2 W 10% TA52
F805	0RP0020J809	0.02 OHM 1 W 20% TA52
F806	0RP0020J809	0.02 OHM 1 W 20% TA52
FR402	0RP0050H709	0.05 OHM 1/2 W 10% TA52
FR403	0RP0050H709	0.05 OHM 1/2 W 10% TA52
FR404	0RP0050H709	0.05 OHM 1/2 W 10% TA52
FR405	0RP0050H709	0.05 OHM 1/2 W 10% TA52
J201	0RD1000F609	100 OHM 1/6 W 5% TA52
J211	0RD1000F609	100 OHM 1/6 W 5% TA52
J262	0RD0102F609	10 OHM 1/6 W 5% TA52
J263	0RD0102F609	10 OHM 1/6 W 5% TA52
R102	0RD6801F609	6.8K OHM 1/6 W 5.00% TA52
R109	0RD0562F609	56 OHM 1/6 W 5.00% TA52
R110	0RD8200F609	820 OHM 1/6 W 5.00% TA52
R111	0RD0682F609	68 OHM 1/6 W 5.00% TA52
R112	0RD1501F609	1.5K OHM 1/6 W 5% TA52
R113	0RD3000F609	300 OHM 1/6 W 5.00% TA52
R12	0RD1000F609	100 OHM 1/6 W 5% TA52
R124	0RD2202F609	22K OHM 1/6 W 5% TA52
R125	0RD8200A609	820 OHM 1/2 W(7.0) 5.00% TA52
R1254	0RD2200A609	220 OHM 1/2 W(7.0) 5.00% TA52
R1255	0RD2200A609	220 OHM 1/2 W(7.0) 5.00% TA52
R126	0RD1000F609	100 OHM 1/6 W 5% TA52
R127	0RD1000F609	100 OHM 1/6 W 5% TA52
R13	0RD1301F609	1.3K OHM 1/6 W 5.00% TA52
R14	0RD4701F609	4.7K OHM 1/6 W 5% TA52
R15	0RD3300F609	330 OHM 1/6 W 5.00% TA52
R16	0RD2200F609	220 OHM 1/6 W 5.00% TA52
R17	0RD3000F609	300 OHM 1/6 W 5.00% TA52
R18	0RD3300F609	330 OHM 1/6 W 5.00% TA52
R19	0RD3900F609	390 OHM 1/6 W 5% TA52
R20	0RD4300F609	430 OHM 1/6 W 5.00% TA52
R202	0RD0752F609	75 OHM 1/6 W 5.00% TA52
R203	0RD0752F609	75 OHM 1/6 W 5.00% TA52
R204	0RD0752F609	75 OHM 1/6 W 5.00% TA52
R205	0RD0752F609	75 OHM 1/6 W 5.00% TA52
R207	0RD5602F609	56K OHM 1/6 W 5% TA52
R212	0RD0752F609	75 OHM 1/6 W 5.00% TA52
R213	0RD0752F609	75 OHM 1/6 W 5.00% TA52
R215	0RD2402F609	24K OHM 1/6 W 5.00% TA52

LOCA. NO	PART NO	DESCRIPTION
R217	0RD1000F609	100 OHM 1/6 W 5% TA52
R218	0RD1000F609	100 OHM 1/6 W 5% TA52
R24	0RD1000F609	100 OHM 1/6 W 5% TA52
R25	0RD1000F609	100 OHM 1/6 W 5% TA52
R28	0RD0682F609	68 OHM 1/6 W 5.00% TA52
R29	0RD1000F609	100 OHM 1/6 W 5% TA52
R30	0RD3301F609	3.3K OHM 1/6 W 5.00% TA52
R301	0RD1501A609	1.5K OHM 1/2 W(7.0) 5.00% TA52
R302	0RN4302F409	43K OHM 1/6 W 1.00% TA52
R302	0RN4702F409	47K OHM 1/6 W 1.00% TA52
R303	0RD2400A609	240 OHM 1/2 W(7.0) 5.00% TA52
R304	0RD0561A609	5.6 OHM 1/2 W(7.0) 5.00% TA52
R305	0RD1002F609	10K OHM 1/6 W 5% TA52
R306	0RD1002F609	10K OHM 1/6 W 5% TA52
R307	0RD3601F609	3.6K OHM 1/6 W 5.00% TA52
R308	0RN7502F409	75K OHM 1/6 W 1.00% TA52
R309	0RD2001F609	2K OHM 1/6 W 5% TA52
R31	0RD3301F609	3.3K OHM 1/6 W 5.00% TA52
R310	0RN7502F409	75K OHM 1/6 W 1.00% TA52
R312	0RD4701F609	4.7K OHM 1/6 W 5% TA52
R313	0RD0201A609	2 OHM 1/2 W(7.0) 5.00% TA52
R314	0RD0201A609	2 OHM 1/2 W(7.0) 5.00% TA52
R315	0RS2700K619	270 OHM 2 W 5% TR
R316	0RD1000F609	100 OHM 1/6 W 5% TA52
R317	0RD2702F609	27K OHM 1/6 W 5.00% TA52
R318	0RN2001F409	2K OHM 1/6 W 1.00% TA52
R319	0RN8202F409	82K OHM 1/6 W 1.00% TA52
R32	0RD3301F609	3.3K OHM 1/6 W 5.00% TA52
R320	0RD1001F609	1K OHM 1/6 W 5% TA52
R321	0RD0561A609	5.6 OHM 1/2 W(7.0) 5.00% TA52
R322	0RD1501F609	1.5K OHM 1/6 W 5% TA52
R323	0RD2702F609	27K OHM 1/6 W 5.00% TA52
R324	0RD4700F609	470 OHM 1/6 W 0.05 TA52
R325	0RD2701A609	2.7K OHM 1/2 W(7.0) 5.00% TA52
R326	0RD1501A609	1.5K OHM 1/2 W(7.0) 5.00% TA52
R328	0RN4302F409	43K OHM 1/6 W 1.00% TA52
R328	0RN4702F409	47K OHM 1/6 W 1.00% TA52
R33	0RD1000F609	100 OHM 1/6 W 5% TA52
R35	0RD1000F609	100 OHM 1/6 W 5% TA52
R37	0RD1000F609	100 OHM 1/6 W 5% TA52
R38	0RD1002F609	10K OHM 1/6 W 5% TA52
R401	0RD2701A609	2.7K OHM 1/2 W(7.0) 5.00% TA52
R403	0RD5600A609	560 OHM 1/2 W(7.0) 0.05 TA52
R404	0RD0332A609	33 OHM 1/2 W(7.0) 5.00% TA52
R405	0RS8200K607	820 OHM 2 W 5.00% TA62
R408	0RS0221K619	2.2 OHM 2 W 5% TR
R409	0RD1801A609	1.8K OHM 1/2 W(7.0) 5.00% TA52
R410	0RMZVBK002D	15K OHM 5W +/-5% RSR V-TYPE
R411	0RS5102H609	51K OHM 1/2 W 5.00% TA52
R412	0RD7501A609	7.5K OHM 1/2 W(7.0) 5.00% TA52
R413	0RS2202H609	22K OHM 1/2 W 5.00% TA52
R414	0RS1001H609	1K OHM 1/2 W 5.00% TA52

For Capacitor & Resistors, the characters at 2nd and 3rd digit in the P/No. means as follows;	CC, CX, CK, CN : Ceramic	RD : Carbon Film
	CQ : Polyester	RS : Metal Oxide Film
	CE : Electrolytic	RN : Metal Film
		RF : Fusible

LOCA. NO	PART NO	DESCRIPTION	LOCA. NO	PART NO	DESCRIPTION
R415	0RD1002F609	10K OHM 1/6 W 5% TA52	R563	0RD0752F609	75 OHM 1/6 W 5.00% TA52
R416	0RD6801F609	6.8K OHM 1/6 W 5.00% TA52	R601	0RD0221A609	2.2 OHM 1/2 W(7.0) 5.00% TA52
R417	0RD8203F609	820K OHM 1/6 W 5.00% TA52	R602	0RD0221A609	2.2 OHM 1/2 W(7.0) 5.00% TA52
R42	0RD4701F609	4.7K OHM 1/6 W 5% TA52	R603	0RD0221A609	2.2 OHM 1/2 W(7.0) 5.00% TA52
R421	0RD3600F609	360 OHM 1/6 W 5.00% TA52	R604	0RD0221A609	2.2 OHM 1/2 W(7.0) 5.00% TA52
R422	0RD1002F609	10K OHM 1/6 W 5% TA52	R605	0RD1001F609	1K OHM 1/6 W 5% TA52
R430	0RD4301F609	4.3K OHM 1/6 W 5.00% TA52	R606	0RD4301F609	4.3K OHM 1/6 W 5.00% TA52
R431	0RD1503F609	150K OHM 1/6 W 5% TA52	R607	0RD1002F609	10K OHM 1/6 W 5% TA52
R432	0RD4703F609	470K OHM 1/6 W 5.00% TA52	R608	0RD1001F609	1K OHM 1/6 W 5% TA52
R433	0RD1003A609	100K OHM 1/2 W(7.0) 5.00% TA52	R609	0RD1000F609	100 OHM 1/6 W 5% TA52
R434	0RD1003A609	100K OHM 1/2 W(7.0) 5.00% TA52	R610	0RD1802F509	18K OHM 1/6 W 2.00% TA52
R435	0RD1002F609	10K OHM 1/6 W 5% TA52	R611	0RD1001F609	1K OHM 1/6 W 5% TA52
R436	0RD1000F609	100 OHM 1/6 W 5% TA52	R612	0RD4301F609	4.3K OHM 1/6 W 5.00% TA52
R501	0RD3301F609	3.3K OHM 1/6 W 5.00% TA52	R613	0RD0221F609	2.2 OHM 1/6 W 5.00% TA52
R502	0RN6801F409	6.8K OHM 1/6 W 1.00% TA52	R614	0RD1000F609	100 OHM 1/6 W 5% TA52
R503	0RN6801F409	6.8K OHM 1/6 W 1.00% TA52	R615	0RD1001F609	1K OHM 1/6 W 5% TA52
R504	0RD6801F609	6.8K OHM 1/6 W 5.00% TA52	R616	0RD2700F609	270 OHM 1/6 W 5% TA52
R505	0RD1000F609	100 OHM 1/6 W 5% TA52	R617	0RD6801F609	6.8K OHM 1/6 W 5.00% TA52
R506	0RD2202F609	22K OHM 1/6 W 5% TA52	R618	0RD6801F609	6.8K OHM 1/6 W 5.00% TA52
R507	0RD3300F609	330 OHM 1/6 W 5.00% TA52	R619	0RD6801F609	6.8K OHM 1/6 W 5.00% TA52
R508	0RD1201F609	1.2K OHM 1/6 W 5% TA52	R620	0RD1000F609	100 OHM 1/6 W 5% TA52
R509	0RD3600F609	360 OHM 1/6 W 5.00% TA52	R621	0RD6801F609	6.8K OHM 1/6 W 5.00% TA52
R510	0RD3600F609	360 OHM 1/6 W 5.00% TA52	R624	0RD6801F609	6.8K OHM 1/6 W 5.00% TA52
R511	0RD3600F609	360 OHM 1/6 W 5.00% TA52	R664	0RD6801F609	6.8K OHM 1/6 W 5.00% TA52
R512	0RD0332F609	33 OHM 1/6 W 5.00% TA52	R803	180-822N	RWR 7W 1.0 OHM J PD
R513	0RD0332F609	33 OHM 1/6 W 5.00% TA52	R804	0RS4702K619	47K OHM 2 W 5% TR
R514	0RD0332F609	33 OHM 1/6 W 5.00% TA52	R805	0RS4702K607	47K OHM 2 W 5.00% TA62
R515	0RD1600F609	160 OHM 1/6 W 5.00% TA52	R806	180-A01N	0.18 OHM 2 W 5% TA62 PRW
R516	0RD1600F609	160 OHM 1/6 W 5.00% TA52	R807	0RD2200A609	220 OHM 1/2 W(7.0) 5.00% TA52
R517	0RD1600F609	160 OHM 1/6 W 5.00% TA52	R808	0RD1501F609	1.5K OHM 1/6 W 5% TA52
R518	0RD0222F609	22 OHM 1/6 W 5.00% TA52	R809	0RD1001F609	1K OHM 1/6 W 5% TA52
R519	0RD2701F609	2.7K OHM 1/6 W 5% TA52	R810	0RD0182F609	18 OHM 1/6 W 5.00% TA52
R520	0RD1001F609	1K OHM 1/6 W 5% TA52	R814	0RK8204H609	8.2M OHM 1/2 W 5.00% TA52
R521	0RD3002F609	30K OHM 1/6 W 5.00% TA52	R816	0RD1001F609	1K OHM 1/6 W 5% TA52
R522	0RD0302F609	30 OHM 1/6 W 5.00% TA52	R817	0RD0302F609	30 OHM 1/6 W 5.00% TA52
R523	0RD1000F609	100 OHM 1/6 W 5% TA52	R818	0RKZVTA001K	0.47M OHM 1/2 W 5% TA52
R524	0RD1000F609	100 OHM 1/6 W 5% TA52	R819	0RF0470K619	0.47 OHM 2 W 5% TR
R526	0RD1201F609	1.2K OHM 1/6 W 5% TA52	R823	0RD4701F609	4.7K OHM 1/6 W 5% TA52
R527	0RD2702F609	27K OHM 1/6 W 5.00% TA52	R825	0RD4701F609	4.7K OHM 1/6 W 5% TA52
R530	0RD5101F609	5.1K OHM 1/6 W 5.00% TA52	R827	0RD1001F609	1K OHM 1/6 W 5% TA52
R532	0RD1000F609	100 OHM 1/6 W 5% TA52	R828	0RD1501F609	1.5K OHM 1/6 W 5% TA52
R534	0RD1201F609	1.2K OHM 1/6 W 5% TA52	R831	0RD2201F609	2.2K OHM 1/6 W 5.00% TA52
R535	0RD2200F609	220 OHM 1/6 W 5.00% TA52	R838	0RD4701F609	4.7K OHM 1/6 W 5% TA52
R536	0RD1801F609	1.8K OHM 1/6 W 5.00% TA52	R858	0RD4701F609	4.7K OHM 1/6 W 5% TA52
R539	0RD1002F609	10K OHM 1/6 W 5% TA52	R903	0RD2200F609	220 OHM 1/6 W 5.00% TA52
R540	0RD4702F609	47K OHM 1/6 W 5% TA52	R904	0RD2200F609	220 OHM 1/6 W 5.00% TA52
R542	0RD8200F609	820 OHM 1/6 W 5.00% TA52	R905	0RD2200F609	220 OHM 1/6 W 5.00% TA52
R543	0RD9100F609	910 OHM 1/6 W 5.00% TA52	R906	0RD1000F609	100 OHM 1/6 W 5% TA52
R545	0RD1002F609	10K OHM 1/6 W 5% TA52	R907	0RD1000F609	100 OHM 1/6 W 5% TA52
R555	0RD6800F609	680 OHM 1/6 W 5% TA52	R908	0RD1000F609	100 OHM 1/6 W 5% TA52
R557	0RD3301F609	3.3K OHM 1/6 W 5.00% TA52	R909	0RCZVTA002D	1/2 W 1.5K,10%,PLIKOR(HIGH SURGE)
R558	0RD3001F609	3K OHM 1/6 W 5.00% TA52	R910	0RCZVTA002D	1/2 W 1.5K,10%,PLIKOR(HIGH SURGE)

SVC. SHEET : 3854VA0204A-S



P/NO : 3828VD0219E

Dec., 2005
Printed in Korea