



CYPRESS

PRELIMINARY

CYM9244, CYM9245
CYM9246, CYM9247

128K/256K Cache Module Family for the OPTi 802GP Chip Set

Features

- 128 Kbyte (CYM9244 & CYM9246), 256 Kbyte (CYM9245 & CYM9247), secondary cache modules
- Ideal for Intel™ 486 systems with the OPTi 802GP chip-set
- Zero-wait-state operations at 33 MHz
- Constructed using cost-effective CMOS asynchronous SRAMs
- On-board decoupling capacitors offer improved noise immunity
- 112-position Burndy connector, part # CELP2X56SC3Z48
- 5V (±5%) power supply

• TTL-compatible inputs/outputs

Functional Description

These modules are designed to function as the secondary cache in Intel 486-based systems with the OPTi 802GP chip-set. Each module contains either one or two banks of 32-bit wide data SRAMs, an 8-bit wide tag RAM, and a single-bit dirty RAM with separate I/O (CYM9246 and CYM9247 only). The addresses for the data SRAMs are buffered by an on-board latch. Asynchronous CMOS SRAMs are used to provide a low-cost, low-power, and zero-wait-state solution for CPU speeds up to 33 MHz. Multiple ground

pins and on-board decoupling capacitors ensure maximum protection from noise.

Each module interfaces with the rest of the system via a 112-pin Burndy connector. All components on the cache module are surface mounted on a multi-layer epoxy laminate (FR-4) board. The package dimensions are 3.15" x 0.365" x 1.1". All inputs and outputs of the CYM9244, CYM9245, CYM9246, and CYM9247 cache modules are TTL compatible and operate from a single 5V power supply. The contact pins are plated with 100 micro-inches of nickel covered by 10 micro-inches of gold flash.

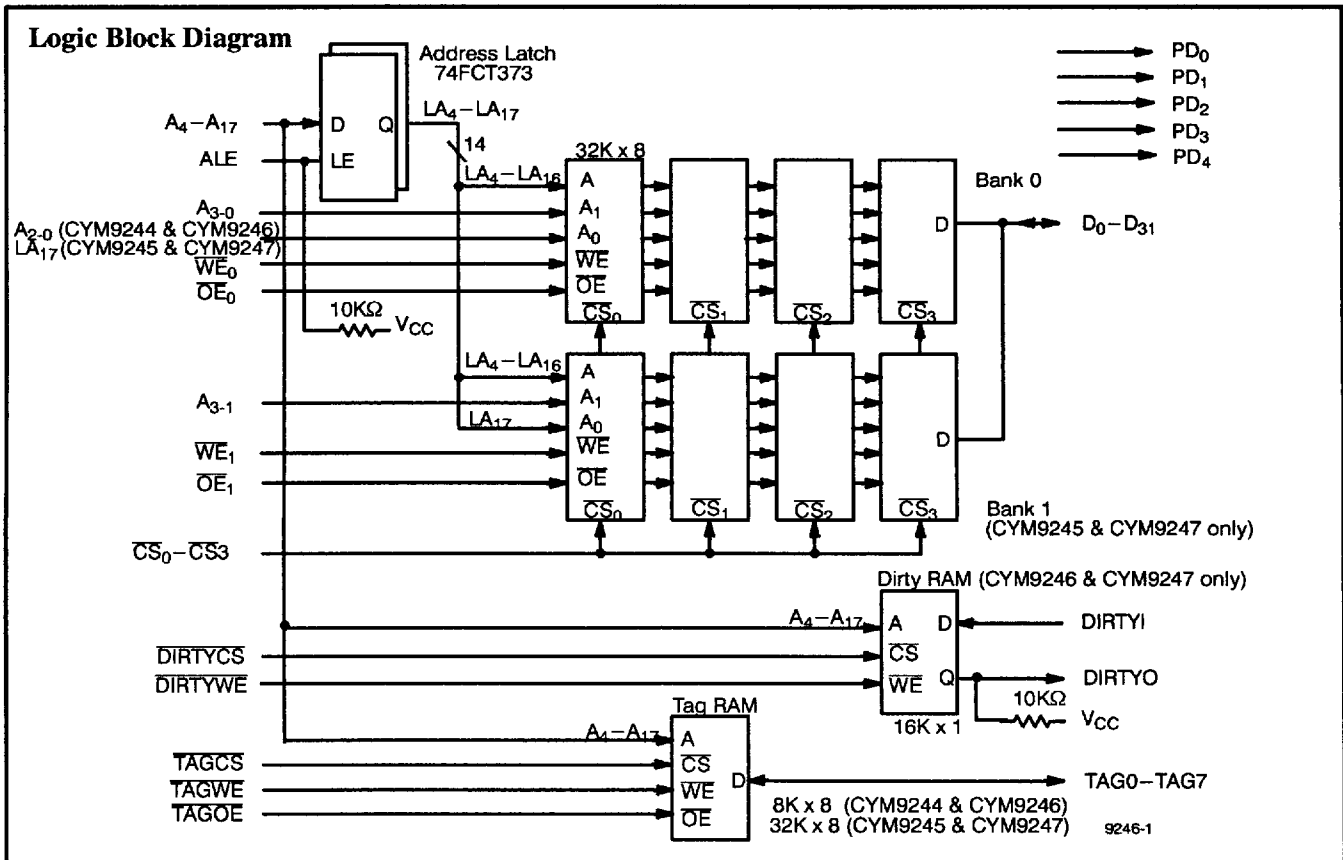

Selection Guide

	CYM9244PB-20C	CYM9245PB-20C	CYM9246PB-20C	CYM9247PB-20C
Cache Size (KB)	128	256	128	256
Data SRAM (ns)	20	20	20	20
Dirty SRAM (ns)			20	20
Tag/Valid SRAM (ns)	15	15	15	15

Intel is a trademark of Intel Corporation.

Cypress Semiconductor Corporation • 3901 North First Street • San Jose • CA 95134 • 408-943-2600

March 1995

■ 2589662 0017153 088 ■

Pin Configuration
**Dual Read-out SIMM
Top View**

GND	57	1	GND
D ₀	58	2	D ₁
D ₂	59	3	D ₃
D ₄	60	4	D ₅
D ₆	61	5	D ₇
V _{CC}	62	6	V _{CC}
NC	63	7	NC
D ₈	64	8	D ₉
D ₁₀	65	9	D ₁₁
D ₁₂	66	10	D ₁₃
GND	67	11	GND
D ₁₄	68	12	D ₁₅
D ₁₆	69	13	D ₁₇
D ₁₈	70	14	D ₁₉
D ₂₀	71	15	D ₂₁
V _{CC}	72	16	V _{CC}
D ₂₂	73	17	D ₂₃
NC	74	18	NC
D ₂₄	75	19	D ₂₅
D ₂₆	76	20	D ₂₇
GND	77	21	GND
D ₂₈	78	22	D ₂₉
D ₃₀	79	23	D ₃₁
(CYM9244 & CYM9246) A ₂₋₀	80	24	A ₂₋₁ (not used)
A ₃₋₀	81	25	A ₃₋₁ (CYM9245 & CYM9247)
V _{CC}	82	26	V _{CC}
A ₄	83	27	A ₅
A ₆	84	28	A ₇
A ₈	85	29	A ₉
A ₁₀	86	30	A ₁₁
A ₁₂	87	31	A ₁₃
A ₁₄	88	32	A ₁₅
A ₁₆	89	33	A ₁₇
A ₁₈	90	34	NC
GND	91	35	GND
(CYM9246 & CYM9247) DIRTYI	92	36	DIRTYO (CYM9246 & CYM9247)
TAG0	93	37	TAG1
TAG2	94	38	TAG3
TAG4	95	39	TAG5
GND	96	40	GND
TAG6	97	41	TAG7
NC	98	42	NC
TAGCS	99	43	ALE
TAGWE	100	44	CS ₀
V _{CC}	101	45	V _{CC}
GND	102	46	GND
TAGOE	103	47	CS ₁
(CYM9246 & CYM9247) DIRTYWE	104	48	CS ₂
(CYM9246 & CYM9247) DIRTYCS	105	49	CS ₃
V _{CC}	106	50	V _{CC}
OE ₀	107	51	OE ₁ (CYM9245 & CYM9247)
WE ₀	108	52	WE ₁ (CYM9245 & CYM9247)
PD ₀	109	53	PD ₁
PD ₂	110	54	PD ₃
PD ₄	111	55	NC
GND	112	56	GND

9246-2

Maximum Ratings

(Above which the useful life may be impaired. For user guidelines, not tested.)

 Storage Temperature -55°C to $+125^{\circ}\text{C}$
 Ambient Temperature with
 Power Applied -0°C to $+70^{\circ}\text{C}$
 Supply Voltage to Ground Potential -0.5V to $+7.0\text{V}$
 DC Voltage Applied to Outputs
 in High Z State -0.5V to $+7.0\text{V}$

 DC Input Voltage -0.5V to $+7.0\text{V}$
 Output Current into Outputs (LOW) 20 mA

Operating Range

Range	Ambient Temperature	V _{CC}
Commercial	0°C to +70°C	5V ± 5%

Electrical Characteristics Over the Operating Range

Parameter	Description	Test Conditions	CYM9244, CYM9245, CYM9246, CYM9247		Unit
			Min.	Max.	
V _{OH}	Output HIGH Voltage	V _{CC} =Min., I _{OH} =-4.0 mA	2.4		V
V _{OL}	Output LOW Voltage	V _{CC} =Min., I _{OL} =8.0 mA		0.4	V
V _{IH}	Input HIGH Voltage		2.2	V _{CC} +0.3	V
V _{IL}	Input LOW Voltage		-0.5	0.8	V
I _{CC}	V _{CC} Operating Supply Current (CYM9244)	V _{CC} =Max., I _{OUT} =0 mA, f=f _{MAX} =1/t _{RC}		950	mA
I _{CC}	V _{CC} Operating Supply Current (CYM9245)	V _{CC} =Max., I _{OUT} =0 mA, f=f _{MAX} =1/t _{RC}		1700	mA
I _{CC}	V _{CC} Operating Supply Current (CYM9246)	V _{CC} =Max., I _{OUT} =0 mA, f=f _{MAX} =1/t _{RC}		1050	mA
I _{CC}	V _{CC} Operating Supply Current (CYM9247)	V _{CC} =Max., I _{OUT} =0 mA, f=f _{MAX} =1/t _{RC}		1800	mA

Presence Detect Table

	PD ₄	PD ₃	PD ₂	PD ₁	PD ₀
CYM9244	NC	NC	NC	NC	GND
CYM9245	NC	NC	NC	GND	NC
CYM9246	GND	NC	NC	NC	GND
CYM9247	GND	NC	NC	GND	NC

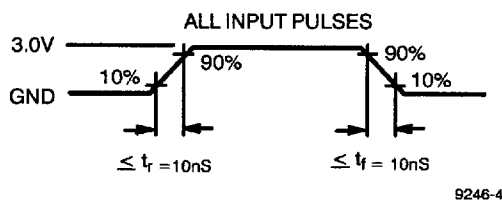
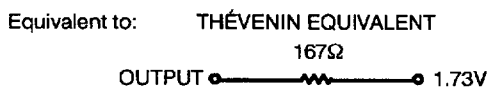
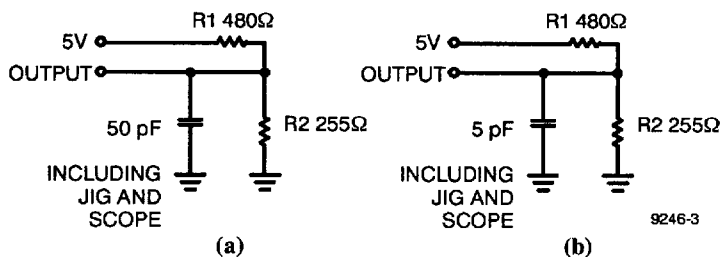
AC Test Loads and Waveforms



Switching Characteristics

Parameter	Description	Min.	Max.	Unit
ALE Timing				
t _{LE}	ALE HIGH to Change in Latched Address	8.5		ns
t _{PD}	Address Propagation Delay Through FCT373A Latch		5.2	ns
Data SRAM Read Timing				
t _{RC}	Read Cycle Time ^[1]	27		ns
t _{AA1}	Address Access Time (A ₄ –A ₁₇ , Latch Transparent)		27	ns
t _{AA2}	Address Access Time (A ₂₋₀ , A ₃₋₀ , A ₃₋₁ , No Latch Path)		22	ns
t _{OHA}	Output Hold from Address Change ^[2]	3		ns
t _{OE}	$\overline{OE}[1:0]$ LOW to Output Valid		11	ns
t _{CE}	$\overline{CS}[7:0]$ LOW to Data Output Valid		22	ns
t _{LZOE}	$\overline{OE}[1:0]$ LOW to Low Z ^[2]	0		ns
t _{HZOE}	$\overline{OE}[1:0]$ HIGH to High Z ^[2]		11	ns
t _{LZCE}	$\overline{CS}[7:0]$ LOW to Low Z ^[2]	3		ns
t _{HZCE}	$\overline{CS}[7:0]$ HIGH to High Z ^[2]		11	ns
t _{PU}	$\overline{CS}[7:0]$ LOW to Power-Up ^[2]	0		ns
t _{PD}	$\overline{CS}[7:0]$ HIGH to Power-Down ^[2]		22	ns
Tag SRAM Read Timing				
t _{TRC}	Tag Read Cycle Time ^[1]	17		ns
t _{TAA}	Tag Address Access Time		17	ns
t _{OHA}	Tag Output Hold from Address Change ^[2]	3		ns
t _{TCS}	\overline{TAGCS} LOW to Tag Valid		17	ns
t _{TOE}	$\overline{TAGO\overline{E}}$ LOW to Tag Valid		9	ns
t _{TLZOE}	$\overline{TAGO\overline{E}}$ LOW to Tag Low Z ^[2]	0		ns
t _{THZOE}	$\overline{TAGO\overline{E}}$ HIGH to Tag High Z ^[2]		10	ns
t _{TLZCE}	\overline{TAGCS} LOW to Tag Low Z ^[2]	3		ns
t _{THZCE}	\overline{TAGCS} HIGH to Tag High Z ^[2]		10	ns
t _{TPU}	\overline{TAGCS} LOW to Tag RAM Power-Up ^[2]	0		ns
Dirty SRAM Read Timing (CYM9246 & CYM 9247)				
t _{DRC}	Dirty Read Cycle Time ^[1]	22		ns
t _{DAA}	Dirty Address Access Time		22	ns
t _{DOHA}	DIRTYO Hold from Address Change ^[2]	1		ns
t _{DCS}	$\overline{DIRTYCS}$ LOW to DIRTYO Valid		20	ns
t _{DLZCE}	$\overline{DIRTYCS}$ LOW to DIRTYO Low Z ^[2]	5		ns
t _{DHZCE}	$\overline{DIRTYCS}$ HIGH to DIRTYO High Z ^[2]		10	ns
t _{DPU}	$\overline{DIRTYCS}$ LOW to Dirty RAM Power-Up ^[2]	0		ns
t _{DPD}	$\overline{DIRTYCS}$ HIGH to Dirty RAM Power-Down ^[2]		17	ns



Switching Characteristics (continued)

Parameters	Description	Min.	Max.	Units
Data SRAM Write Timing				
t _{WC}	Write Cycle Time ^[1]	27		ns
t _{SCE}	CS[7:0] LOW to End of Write ^[1]		22	ns
t _{AW1}	Address Set-Up to End of Write (A ₄ –A ₁₇) ^[1]	20		ns
t _{AW2}	Address Set-Up to End of Write (A ₂₋₀ , A ₃₋₀ , A ₃₋₁ , No Latch Path) ^[1]	15		ns
t _{HA}	Address Hold from End of Write ^[2]	0		ns
t _{SA}	Address Set-Up to Start of Write ^[2]	0		ns
t _{PWE}	WE[1:0] Pulse Width ^[1]	15		ns
t _{SD}	Data Set-Up to End of Write ^[2]	12		ns
t _{HD}	Data Hold from End of Write ^[2]	0		ns
t _{LZWE}	WE[1:0] LOW to High Z ^[2]		12	ns
t _{HZWE}	WE[1:0] HIGH to Low Z ^[2]	3		ns
Tag SRAM Write Timing				
t _{TWC}	Tag Write Cycle Time ^[1]	17		ns
t _{TSCE}	TAGCS LOW to End of Tag Write ^[1]	10		ns
t _{TAW}	Address Set-Up to End of Tag Write ^[1]	10		ns
t _{THA}	Address Hold from End of Tag Write ^[2]	0		ns
t _{TSA}	Address Set-Up to Start of Tag Write ^[2]	0		ns
t _{TWPE}	TAGWE Pulse Width ^[1]	10		ns
t _{TSD}	Tag Set-Up to End of Tag Write ^[2]	11		ns
t _{THD}	Tag Hold from End of Tag Write ^[2]	0		ns
t _{TLZWE}	TAGWE LOW to Tag High Z ^[2]		9	ns
t _{THZWE}	TAGWE HIGH to Tag Low Z ^[2]	3		ns
Dirty SRAM Write Timing (CYM9246 & CYM9247)				
t _{DWC}	Dirty Write Cycle Time ^[1]	27		ns
t _{DDW}	DIRTYI Set-Up to End of Dirty Write ^[1]	12		ns
t _{DDHW}	DIRTYI Hold from End of Dirty Write ^[1]	0		ns
t _{DSCE}	DIRTYCS LOW to End of Dirty Write ^[2]	12		ns
t _{DAW}	Address Set-Up to End of Dirty Write ^[2]	16		ns
t _{DHA}	Address Hold from End of Dirty Write ^[2]	0		ns
t _{DSA}	Address Set-Up to Start of Dirty Write ^[2]	0		ns
t _{DWPE}	DIRTYWE Pulse Width ^[1]	12		ns
t _{DLZWE}	DIRTYWE LOW to DIRTYO pulled HIGH ^[2]		9	ns
t _{DHZWE}	DIRTYWE HIGH to DIRTYO Low Z ^[2]	5		ns

Notes:

1. Tested initially and after any design or process changes that may affect these parameters.
2. Parameters guaranteed by design, not tested.

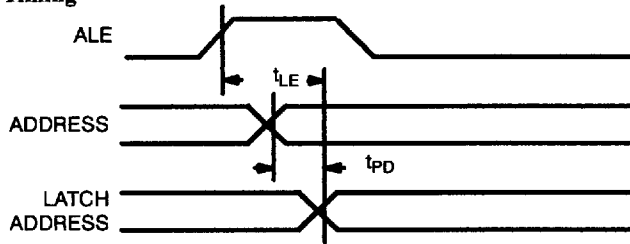
Switching Waveforms
ALE Timing

9246-5

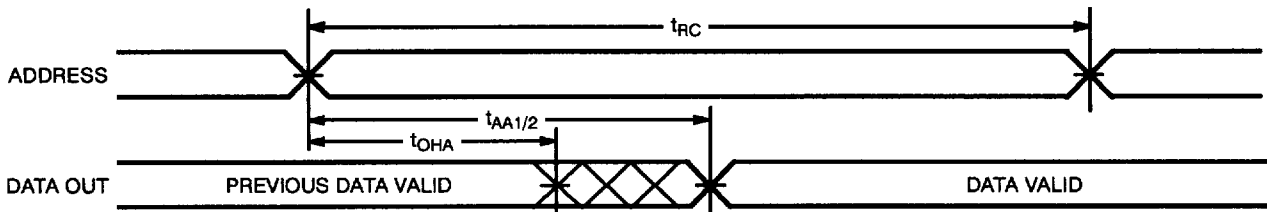
Data Read Cycle No. 1^[3, 4]

9246-6

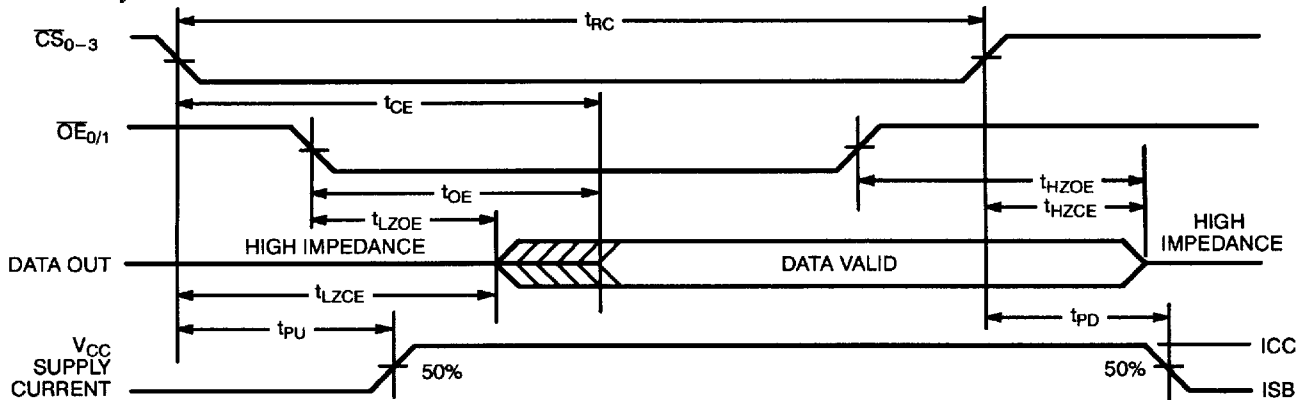
Data Read Cycle No. 2^[14, 5]

9246-7

Notes:

3. Device is continuously selected. $\overline{OE}_{0/1}, \overline{CS}_{0-3} = V_{IL}$.
4. $\overline{WE}_{0/1}$ is HIGH for read cycle.
5. Address valid prior to or coincident with \overline{CS}_{0-3} transition LOW.
6. The internal write time of the memory is defined by the overlap of \overline{CS} LOW and \overline{WE} LOW. Both signals must be LOW to initiate a write and

either signal can terminate a write by going HIGH. The data input set-up and hold timing should be referenced to the rising edge of the signal that terminates the write.

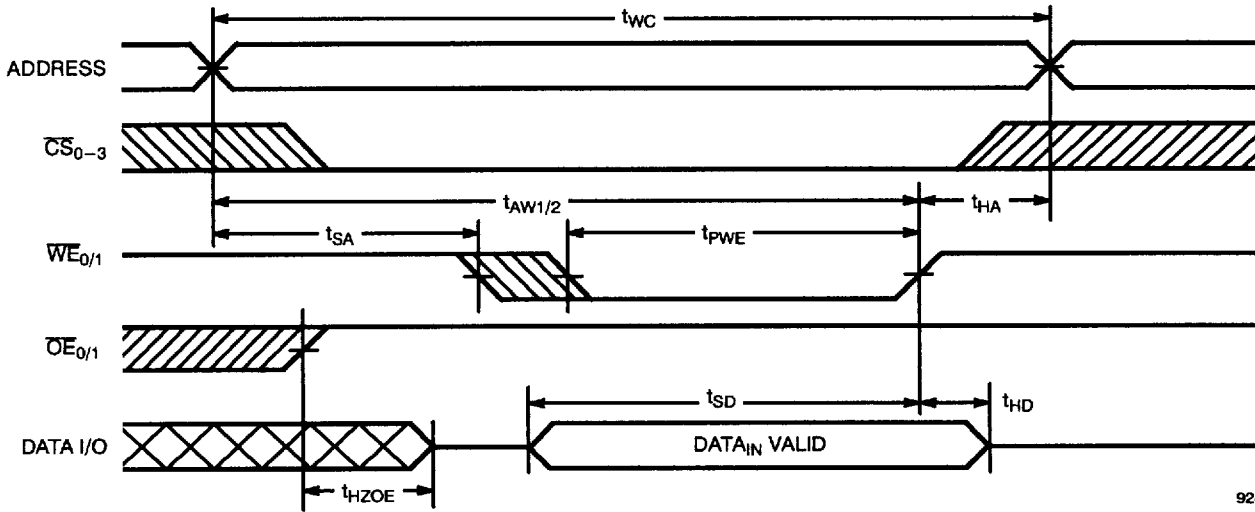
Switching Waveforms (continued)
Data Write Cycle No. 1 (\overline{WE} Controlled)[6, 7, 8]

9246-8

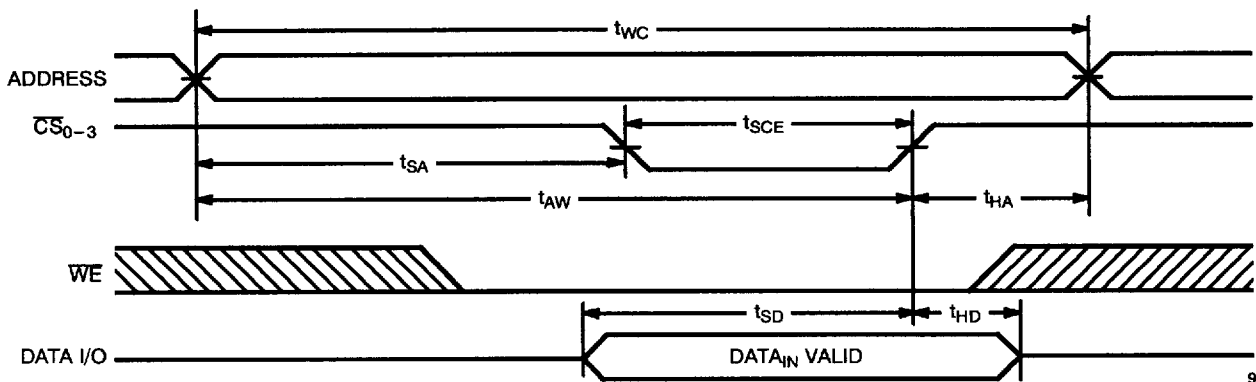
Data Write Cycle No. 2 ($\overline{CS}[0-3]$ Controlled)[16, 17, 8]

9246-9

Notes:

 7. Data I/O is high impedance if $\overline{OE}_{0/1} = V_{IH}$.

 8. If $\overline{CS}_0 - \overline{CS}_3$ goes HIGH simultaneously with WE HIGH, the output remains in a high-impedance state.

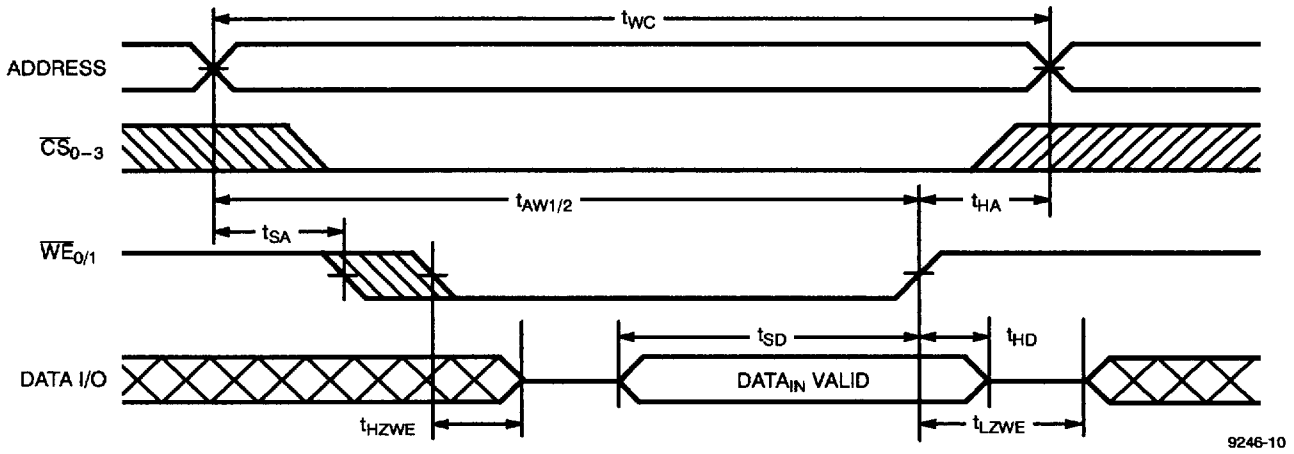
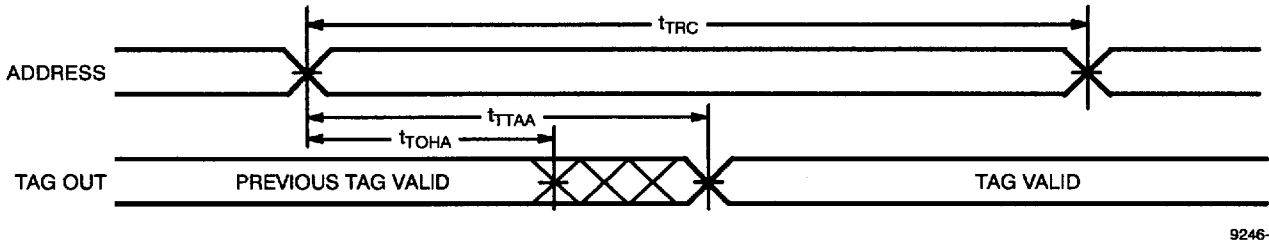
Data Write Cycle No. 3 (\overline{WE} Controlled, \overline{OE} LOW)^[8, 9]

Tag Read Cycle No. 1^[10, 11]

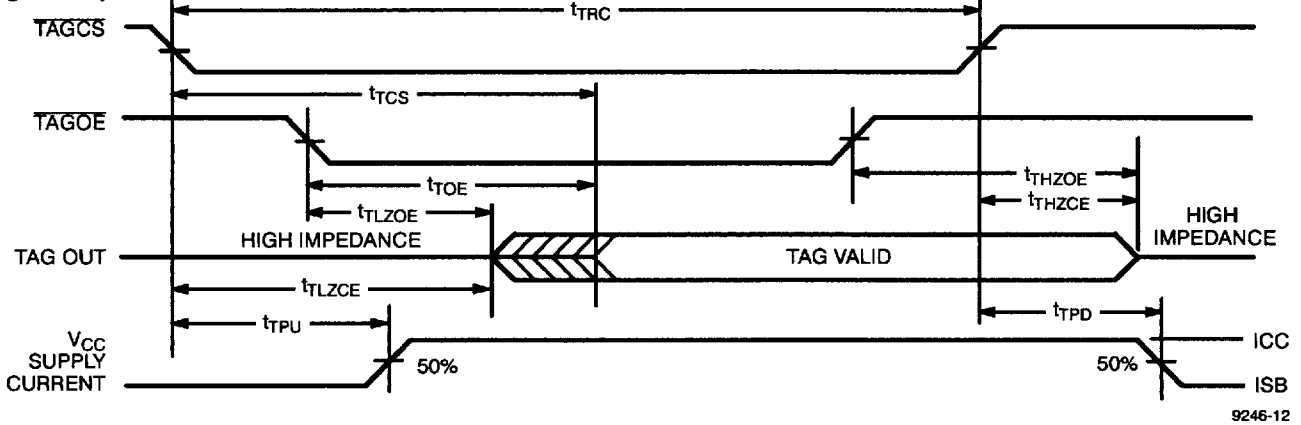
Notes:

9. The minimum write cycle time for write cycle #3 (\overline{WE} controlled, \overline{OE} LOW) is the sum of t_{HZWE} and t_{SD} .
10. Device is continuously selected. \overline{TAGOE} , $\overline{TAGCS} = V_{IL}$.
11. \overline{TAGWE} is HIGH for read cycle.

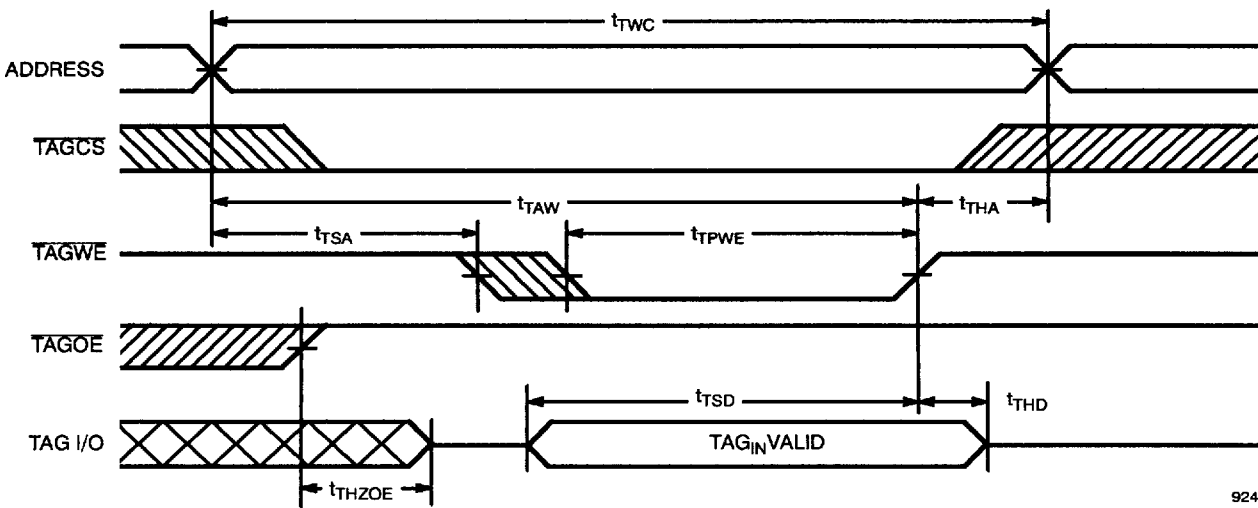
Switching Waveforms (continued)
Tag Read Cycle No. 2^[11, 12]

9246-12

Tag Write Cycle No. 1 (TAGWE Controlled)^[13, 14, 15]

9246-13

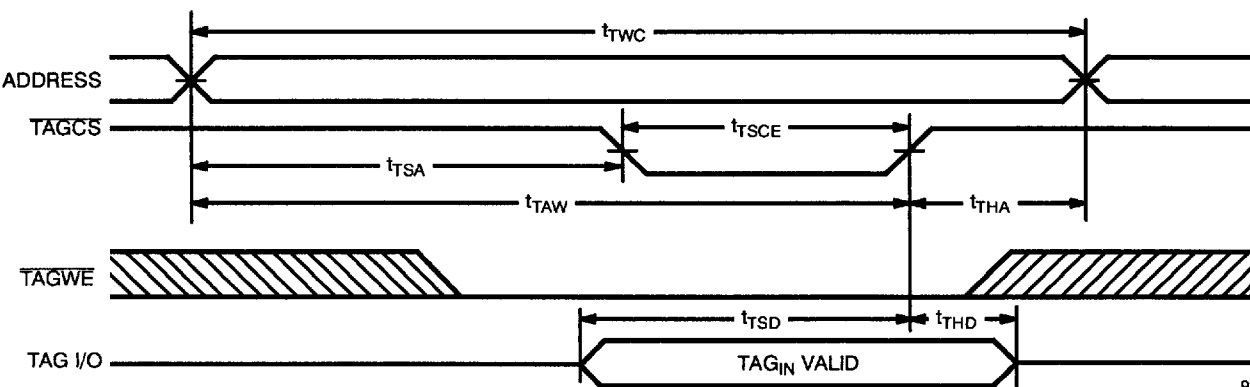
Tag Write Cycle No. 2 (TAGCS Controlled)^[13, 14, 15]

9246-14

Notes:

12. Address valid prior to, or coincident with TAGCS transition LOW.
 13. The internal write time of the memory is defined by the overlap of TAGCS LOW and TAGWE LOW. Both signals must be LOW to initiate a write and either signal can terminate a write by going HIGH. The

- data input set-up and hold timing should be referenced to the rising edge of the signal that terminates the write.
 14. TAG I/O is high impedance if TAGOE = LOW.

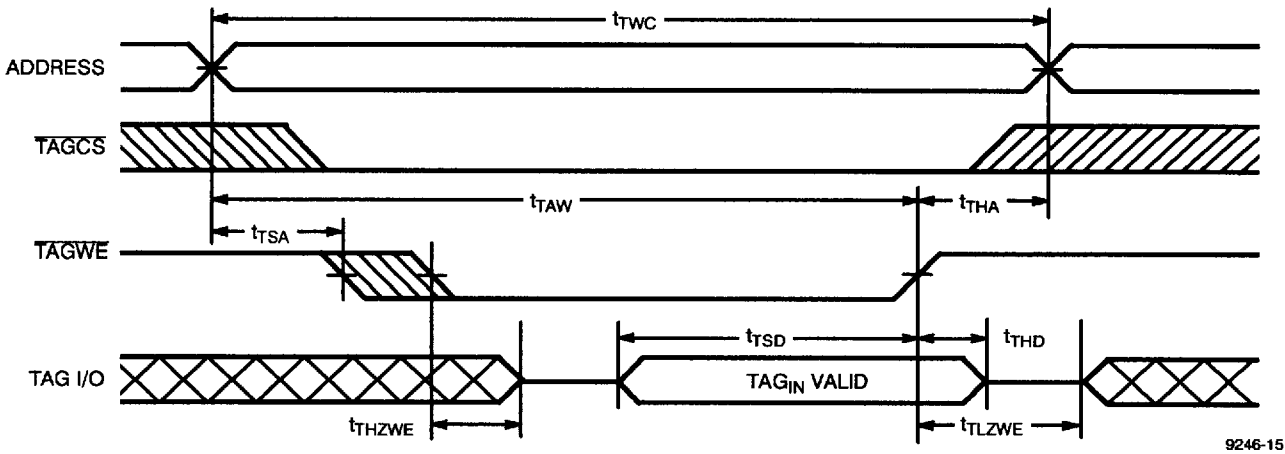
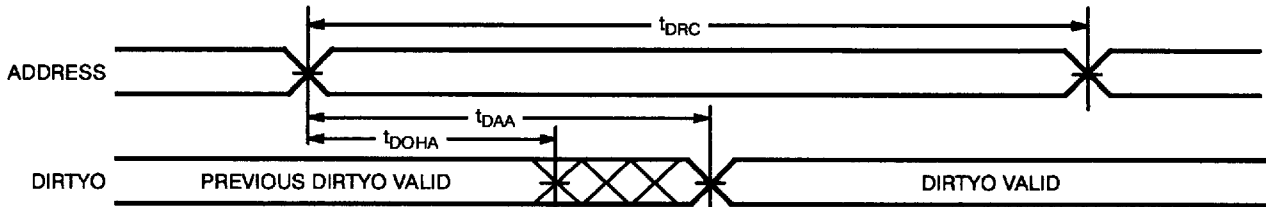
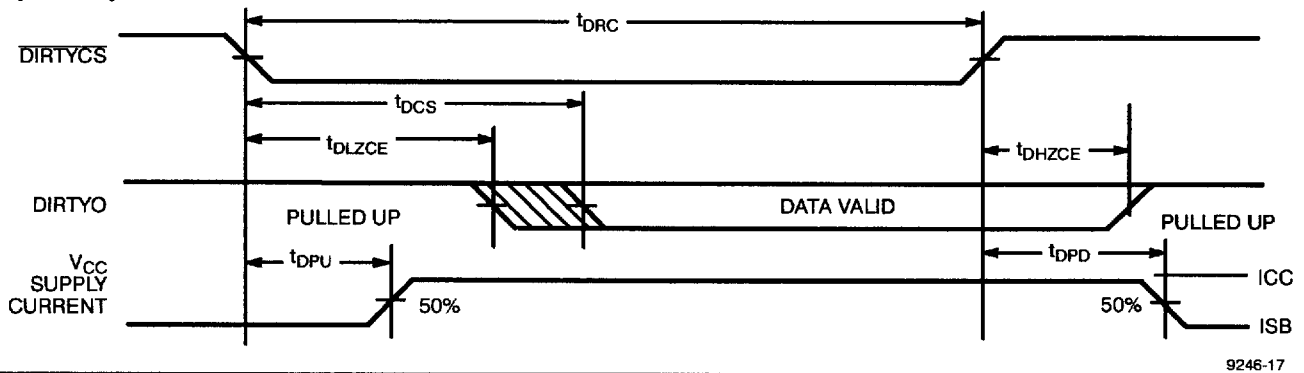
Switching Waveforms (continued)
Tag Write Cycle No. 3 ($\overline{\text{TAGWE}}$ Controlled, $\overline{\text{TAGE}}$ LOW)^[15]

Dirty Read Cycle No. 1^[16, 17]

Dirty Read Cycle No. 2^[11, 18]

Notes:

15. If $\overline{\text{TAGE}}$ goes HIGH simultaneously with $\overline{\text{TAGE}}$ HIGH, the output remains in a high-impedance state.

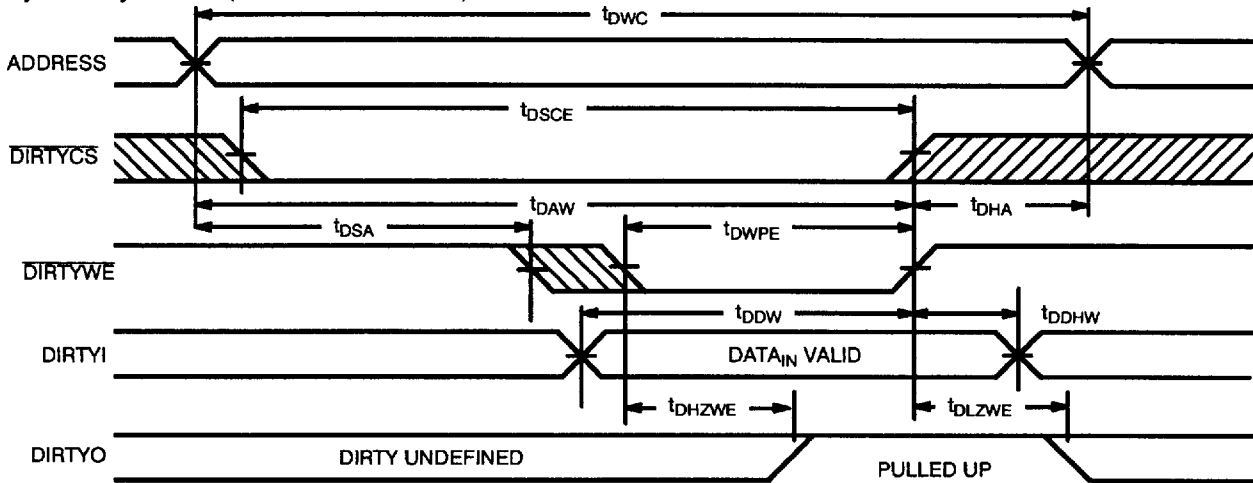
16. $\overline{\text{DIRTYWE}}$ is high for read cycle.

17. Device is continuously selected, $\overline{\text{DIRTYCS}} = V_{IL}$.

18. Address valid prior to or coincident with $\overline{\text{DIRTYCS}}$ transition LOW.

Switching Waveforms (continued)
Dirty Write Cycle No. 1 (DIRTYWE Controlled)^[19]

9246-18

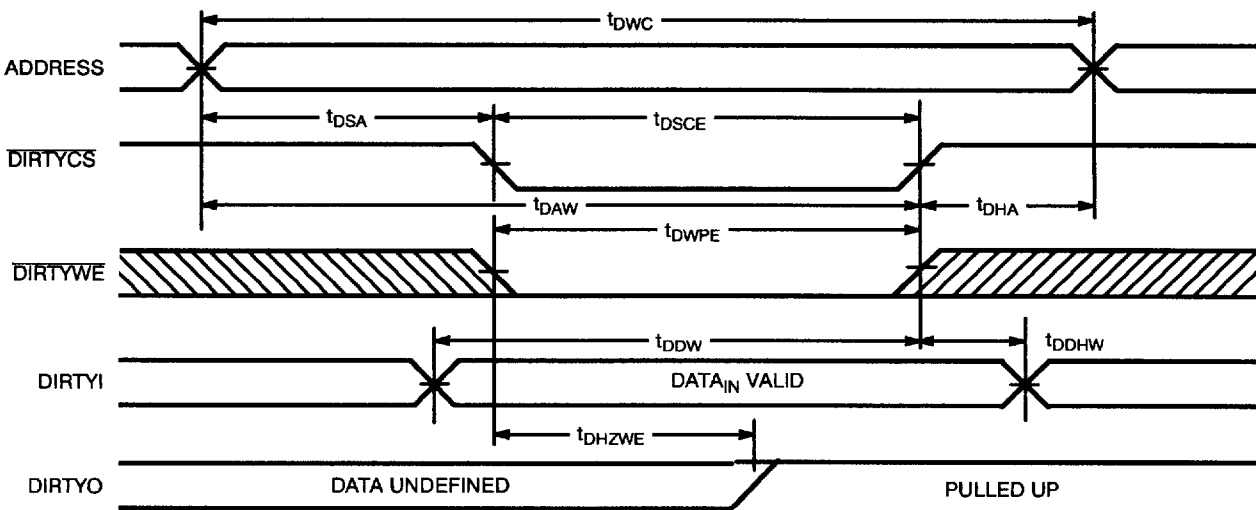
Dirty Write Cycle No. 2 (DIRTYCS Controlled)^[19, 20]

9246-19

Notes:

19. The internal write time of the memory is defined by the overlap of DIRTYCS LOW and DIRTYWE LOW. Both signals must be LOW to initiate a write and either signal can terminate a write by going HIGH. The data input set-up and hold timing should be referenced to the rising edge of the signal that terminates the write.
20. If DIRTYCS goes HIGH simultaneously with DIRTYWE HIGH, the output remains in a high-impedance state.



Ordering Information

Cache Memory Size	Ordering Code	Package Name	Package Type	Operating Range
128 Kbyte	CYM9244PB-20C	PB17	112-Pin Dual-Readout SIMM	Commercial
256 Kbyte	CYM9245PB-20C	PB18	112-Pin Dual-Readout SIMM	Commercial
128 Kbyte	CYM9246PB-20C	PB17	112-Pin Dual-Readout SIMM	Commercial
256 Kbyte	CYM9247PB-20C	PB18	112-Pin Dual-Readout SIMM	Commercial

Document #: 38-M-00072

Package Diagrams

112-Pin Dual-Readout SIMM PB17

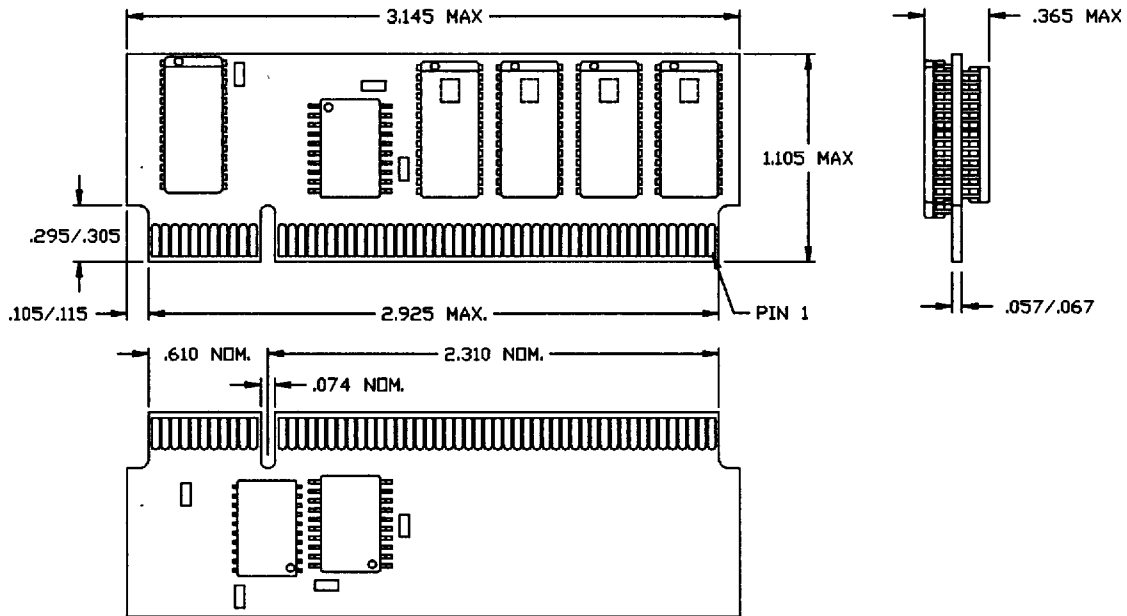

112-Pin Dual-Readout SIMM PB18

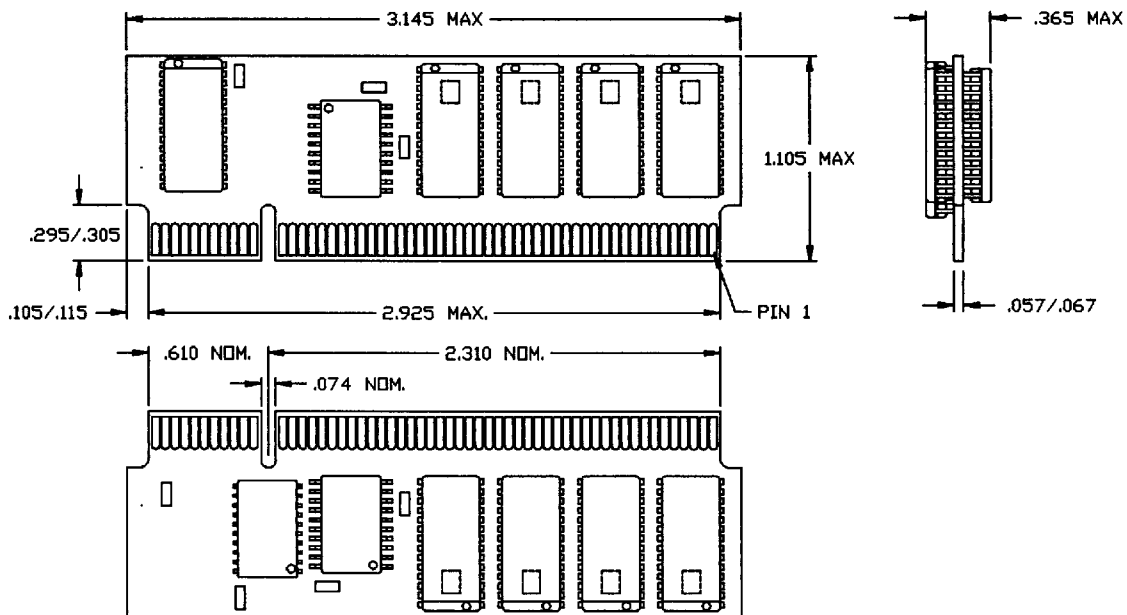

© Cypress Semiconductor Corporation, 1994. The information contained herein is subject to change without notice. Cypress Semiconductor Corporation assumes no responsibility for the use of any circuitry other than circuitry embodied in a Cypress Semiconductor Corporation product. Nor does it convey or imply any license under patent or other rights. Cypress Semiconductor does not authorize its products for use as critical components in life-support systems where a malfunction or failure of the product may reasonably be expected to result in significant injury to the user. The inclusion of Cypress Semiconductor products in life-support systems applications implies that the manufacturer assumes all risk of such use and in so doing indemnifies Cypress Semiconductor against all damages.