

D/A Converter Series for Electronic Adjustments

Standard 8bit 4ch · 6ch Type D/A Converters



BH2227FV, BH2228FV

No.11052EBT04

●Description

The BH2227FV and BH2228FV ICs are 8bit R-2R-type D/A converters with 4 and 6 channels, respectively. Optimized circuitry allows two output voltages to be supplied (3V/5V). Furthermore, the built-in RESET function ensures that the output voltage at all channels is Low during power up. A broad power supply voltage range is available (2.7V-5.5V), providing design flexibility.

●Features

- 1) Suitable for 2 independent power sources (3V/5V)
- 2) Built-in RESET function
- 3) High speed output response characteristics
- 4) 3-line serial interface
- 5) Broad power supply voltage range: 2.7V-5.5V

●Applications

DVCs, DSCs, DVDs, CD-Rs, CD-RWs

●Lineup

Parameter	BH2227FV	BH2228FV
Power source voltage range	2.7 to 5.5V	2.7 to 5.5V
Number of channels	4ch	6ch
Current consumption	0.9mA	0.9mA
Differential non linearity error	±1.0LSB	±1.0LSB
Integral non linearity error	±1.5LSB	±1.5LSB
Output current performance	±1.0mA	±1.0mA
Settling time	100µs	100µs
Data transfer frequency	10MHz	10MHz
Input method	CMOS	CMOS
Data latch method	CSB method	CSB method
Package	SSOP-B14	SSOP-B14

●Absolute Maximum Ratings(Ta=25°C)

Parameter	Symbol	Limits	Unit	Remarks
Power source voltage	VCC	-0.3 to 7.0	V	-
Terminal voltage	VIN	-0.3 to VCC	V	-
Storage temperature range	TSTG	-55 to 125	°C	-
Power dissipation	PD	400*1	mW	-

*1 Derated at 4.0mW/ °C at Ta>25°C

*2 This product is not robust against radiation.

● Recommended Operating Conditions(Ta=25°C)

Parameter	Symbol	Limits			Unit	Remarks
		Min.	Typ.	Max.		
VDD power source voltage	VDD	2.7	-	5.5	V	-
VFS voltage to be impressed	VFS	2.7	-	5.5	V	-
Terminal input voltage range	VIN	0	-	VDD	V	-
Analog output current	IO	-1.0	-	1.0	mA	-
Action temperature range	TOPR	-20	-	85	°C	-
Serial clock frequency	FCLK	-	1.0	10.0	MHz	-
Limit load capacity	CL	-	-	0.1	μF	-

● Electrical Characteristics(Unless otherwise specified, VDD=VFS=3.0V, RL=OPEN, CL=0pF, Ta=25°C)

Parameter	Symbol	Limits			Unit	Conditions
		Min.	Typ.	Max.		
<Current consumption>						
VDD system	IDD	-	0.5	1.5	mA	VDD=5V, CLK=1MHz
VFS system	IFS	-	0.3	0.9	mA	
<Logic interface>						
L input voltage	VIL	VSS	-	0.6	V	VDD=5.0V
H input voltage	VIH	2.4	-	VDD	V	VDD=5.0V
Input current	IIN	-10	-	10	μA	
<Buffer amplifier>						
Output zero scale voltage	ZS	VSS	-	0.1	V	00h setting, at no load
		VSS	-	0.3	V	00h setting, IOL=1.0mA
Output full scale voltage	FS1	VDD-0.1	-	VDD	V	FFh setting, at no load
		VDD-0.3	-	VDD	V	FFh setting, IOH=1.0mA
	FS2	VFS-0.1	-	VFS	V	FFh setting, at no load
		VFS-0.3	-	VFS	V	FFh setting, IOH=1.0mA
<D/A converter precision>						
Differential non linearity error	DNL	-1.0	-	1.0	LSB	Input code 02H to FDH
Integral non linearity error	INL	-1.5	-	1.5	LSB	Input code 02H to FDH
VDD power source voltage rise time	trVDD	100	-	-	μs	VDD=0→2.7
Power ON reset release voltage	VPOR	-	1.9	-	V	

● Timing Chart (Unless otherwise specified, VDD = VFS = 3.0V, RL = OPEN, CL = 0pF, Ta = 25°C)

Parameter	Symbol	Limits			Unit	Conditions
		MIN.	TYP.	MAX.		
CLK L level time	tCLKL	50	-	-	ns	
CLK H level time	tCLKH	50	-	-	ns	
DI setup time	tsDI	20	-	-	ns	
DI hold time	thDI	40	-	-	ns	
CSB setup time	tsCSB	50	-	-	ns	
CSB hold time	thCSB	50	-	-	ns	
CSB H level time	tCSBH	50	-	-	ns	
D/A Output settling time	tOUT	-	-	100	μs	CL=50pF,RL=10kΩ

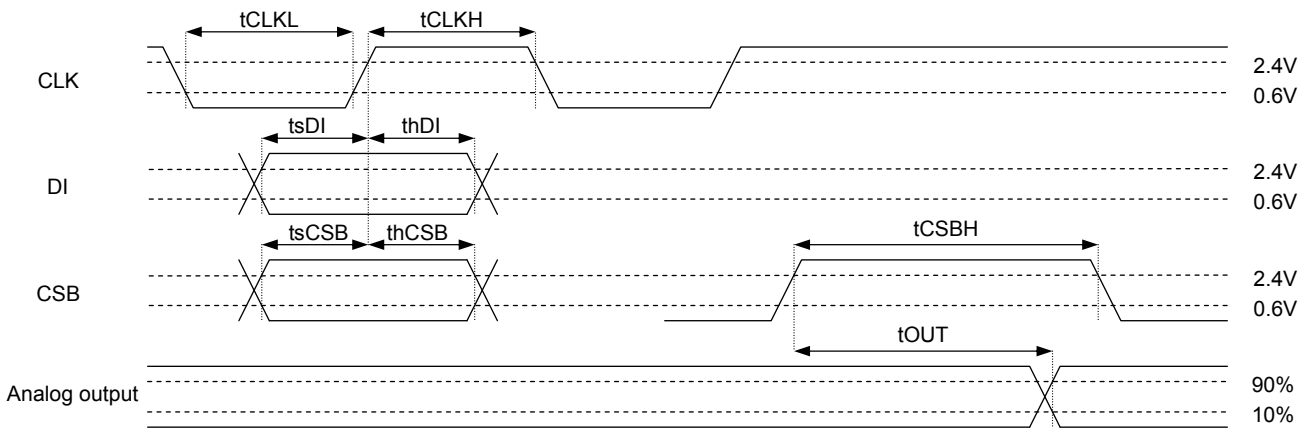

Fig.1

●Terminal Description / Block Diagrams

(BH2227FV)

Terminal	Terminal name	Function
1	AO1	Analog output terminal
2	AO2	
3	TESTMONI1	Test terminal (OPEN at normal use)
4	TESTMONI2	
5	AO3	Analog output terminal
6	AO4	
7	NC	Internally not connected yet
8	NC	
9	VDD	Power source terminal (AO3, 4 full scale voltage use in common)
10	CSB	Chip select signal input terminal
11	CLK	Serial clock input terminal
12	DI	Serial data input terminal
13	VFS	AO1,2 full scale Voltage setting terminal
14	VSS	Ground terminal

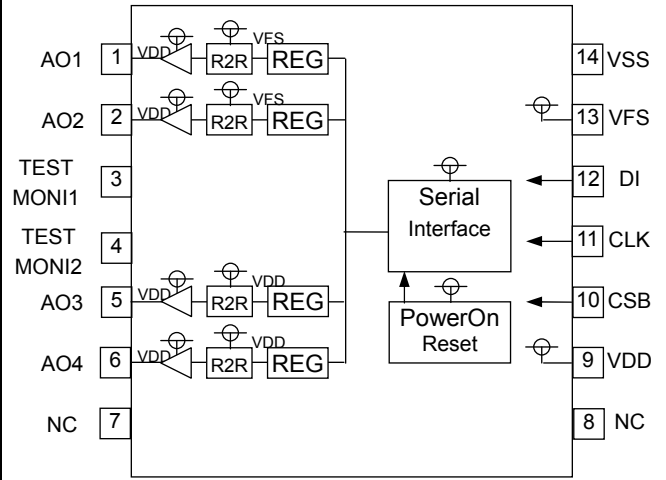

Fig.2

(BH2228FV)

Terminal	Terminal name	Function
1	AO1	Analog output terminal
2	AO2	
3	AO3	
4	AO4	
5	AO5	
6	AO6	
7	NC	Internally not connected yet
8	NC	
9	VDD	Power source terminal (AO4~6 full scale voltage use in common)
10	CSB	Chip select signal input terminal
11	CLK	Serial clock input terminal
12	DI	Serial data input terminal
13	VFS	AO1,2,3 full scale Voltage setting terminal
14	VSS	Ground terminal

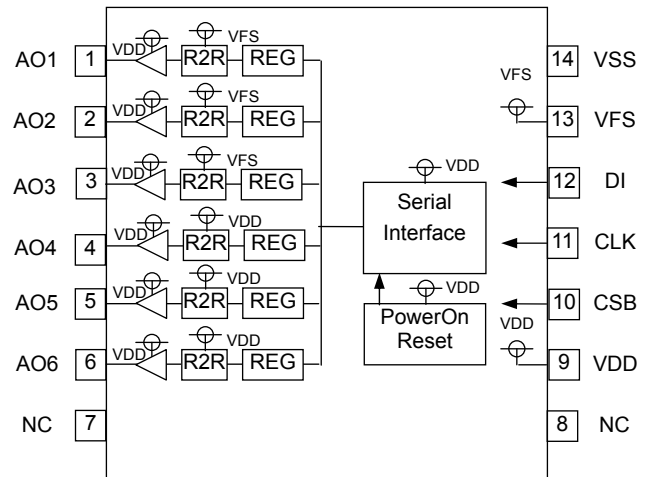

Fig.3

●Equivalent Circuits

Terminal	Equivalent circuit	Terminal	Equivalent circuit
AO1 AO2 AO3 AO4 AO5 AO6		DI CLK CSB	

Fig.4 Equivalent circuit

● Operation Description

Command Transmission

The Control command consists of 3-lines of 12bit serial input data (MSB first).

Data is read at the rise edge of CLK, and data becomes valid in the CSB Low area (before the CSB rise for 12bit data).

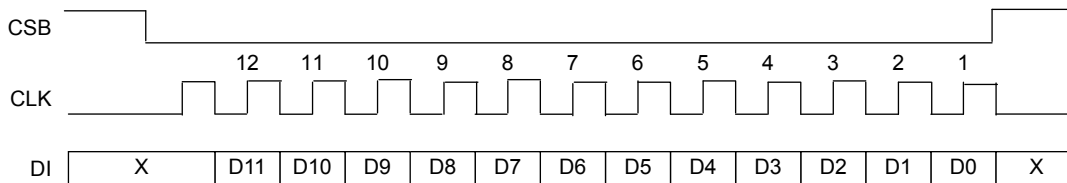

Fig.5

Data Settings

D0	D1	D2	D3	D4	D5	D6	D7	Setting
0	0	0	0	0	0	0	0	GND
1	0	0	0	0	0	0	0	(VDD or VFS-GND)/256x1
0	1	0	0	0	0	0	0	(VDD or VFS-GND)/256x2
1	1	0	0	0	0	0	0	(VDD or VFS-GND)/256x3
0	0	1	0	0	0	0	0	(VDD or VFS-GND)/256x4
~								~
0	1	1	1	1	1	1	1	(VDD or VFS-GND)/256x254
1	1	1	1	1	1	1	1	(VDD or VFS-GND)/256x255

Note: Initial status D[7:0]=00h

Channel Settings

D8	D9	D10	D11	BH2227FV	BH2228FV
0	0	0	0	Inconsequential	Inconsequential
0	0	0	1	AO1	AO1
0	0	1	0	AO2	AO2
0	0	1	1	Inconsequential	AO3
0	1	0	0	Inconsequential	AO4
0	1	0	1	AO3	AO5
0	1	1	0	AO4	AO6
0	1	1	1	Inconsequential	Inconsequential
1	0	0	0	Inconsequential	Inconsequential
1	0	0	1	Inconsequential	Inconsequential
1	0	1	0	Inconsequential	Inconsequential
1	0	1	1	Inconsequential	Inconsequential
1	1	0	0	Inconsequential	Inconsequential
1	1	0	1	Inconsequential	Inconsequential
1	1	1	0	Inconsequential	Inconsequential
1	1	1	1	Inconsequential	Inconsequential

●Electrical Characteristics Curves

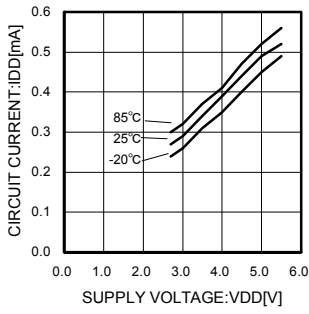

Fig.6 VDD current consumption

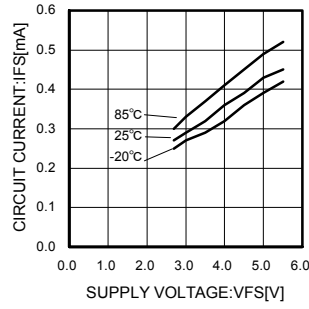

Fig.7 VFS current consumption

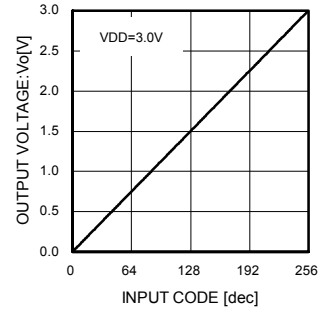

Fig.8 Output voltage characteristic

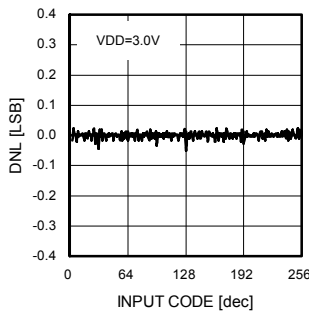

Fig.9 Differential non linearity error

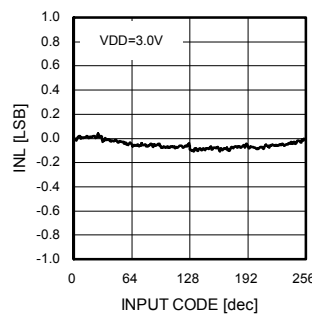

Fig.10 Integral non linearity error

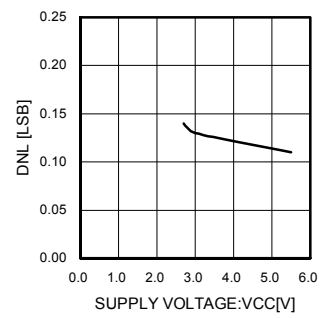

Fig.11 Power source voltage to differential non linearity error

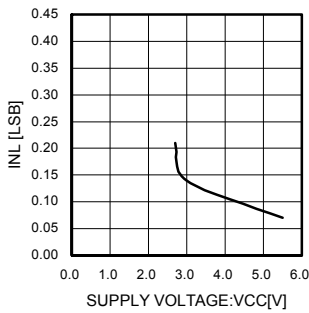

Fig.12 Power source voltage to integral non linearity error

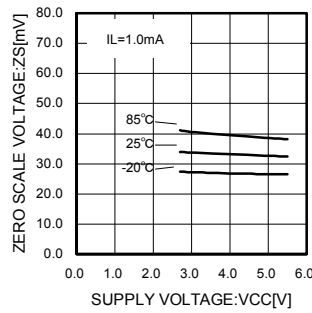

Fig.13 Output zero scale voltage

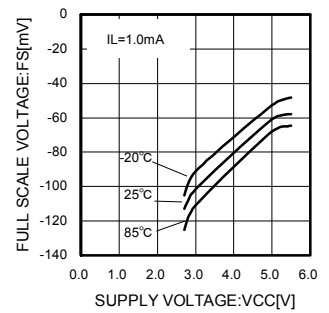

Fig.14 Output full scale voltage

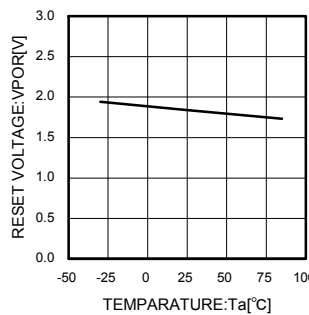

Fig.15 Reset release voltage

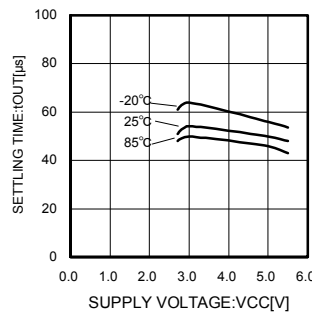

Fig.16 Settling time

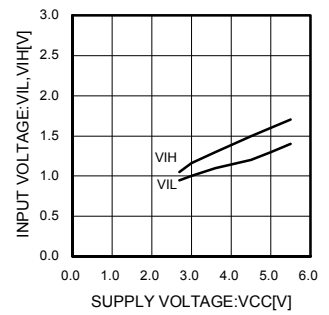

Fig.17 Input voltage

● Operation Notes

(1) Absolute maximum ratings

Operating or testing the device over the maximum specifications may damage the part itself as well as peripheral components. Therefore, please ensure that the specifications are not exceeded.

(2) GND potential

Ensure that the GND terminal is at the lowest potential under all operating conditions.

(3) Thermal design

Use a thermal design that allows for a sufficient margin regarding power dissipation (Pd) under actual operating conditions.

(4) Terminal shorts and mis-mounting

Incorrect orientation or misalignment of the IC when mounting to the PCB may damage part. Short-circuits caused by The introduction of foreign matter between the output terminals or across the output and power supply or GND may also result in destruction.

(5) Operation in a strong magnetic field

Operation in a strong electromagnetic field may cause malfunction.

(6) Set the power source voltage so that $V_{DD} \geq V_{FS}$.

(7) Reset function

The power on reset circuit, which initializes internal settings, may malfunction during abrupt power ons. Therefore, set the time constant so as to satisfy the power source rise time.

● Thermal Derating Curve

• SSOP-B14

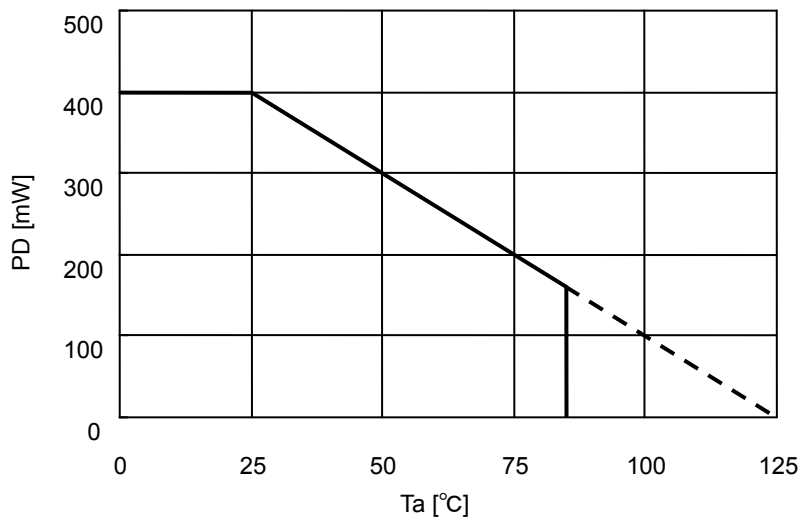

Board size : 70 x 70 x 1.6mm Material : FR4 glass epoxy board (copper foil area less than 3%)

Fig.18

●Ordering part number

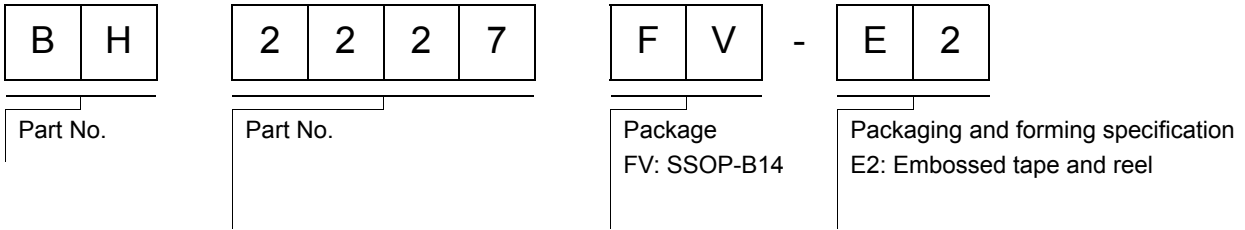

SSOP-B14

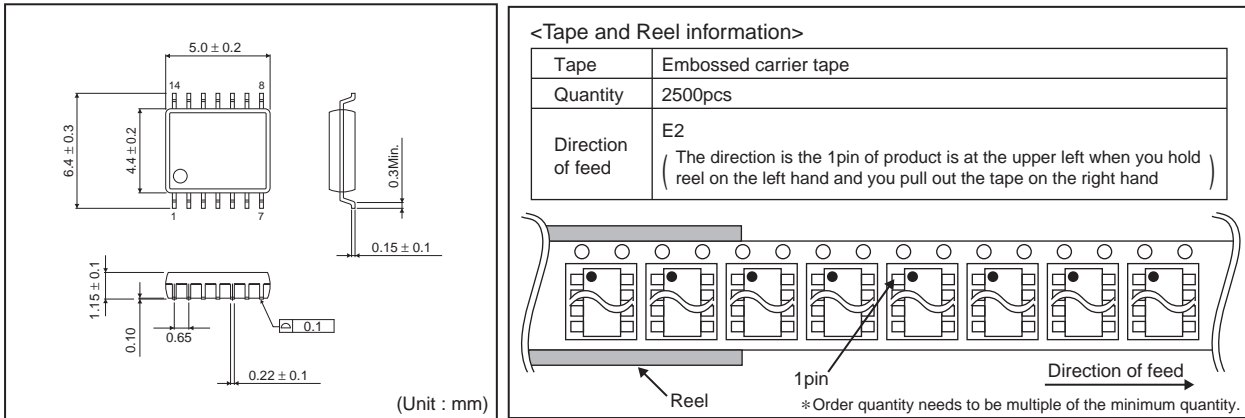

Notes

No copying or reproduction of this document, in part or in whole, is permitted without the consent of ROHM Co.,Ltd.

The content specified herein is subject to change for improvement without notice.

The content specified herein is for the purpose of introducing ROHM's products (hereinafter "Products"). If you wish to use any such Product, please be sure to refer to the specifications, which can be obtained from ROHM upon request.

Examples of application circuits, circuit constants and any other information contained herein illustrate the standard usage and operations of the Products. The peripheral conditions must be taken into account when designing circuits for mass production.

Great care was taken in ensuring the accuracy of the information specified in this document. However, should you incur any damage arising from any inaccuracy or misprint of such information, ROHM shall bear no responsibility for such damage.

The technical information specified herein is intended only to show the typical functions of and examples of application circuits for the Products. ROHM does not grant you, explicitly or implicitly, any license to use or exercise intellectual property or other rights held by ROHM and other parties. ROHM shall bear no responsibility whatsoever for any dispute arising from the use of such technical information.

The Products specified in this document are intended to be used with general-use electronic equipment or devices (such as audio visual equipment, office-automation equipment, communication devices, electronic appliances and amusement devices).

The Products specified in this document are not designed to be radiation tolerant.

While ROHM always makes efforts to enhance the quality and reliability of its Products, a Product may fail or malfunction for a variety of reasons.

Please be sure to implement in your equipment using the Products safety measures to guard against the possibility of physical injury, fire or any other damage caused in the event of the failure of any Product, such as derating, redundancy, fire control and fail-safe designs. ROHM shall bear no responsibility whatsoever for your use of any Product outside of the prescribed scope or not in accordance with the instruction manual.

The Products are not designed or manufactured to be used with any equipment, device or system which requires an extremely high level of reliability the failure or malfunction of which may result in a direct threat to human life or create a risk of human injury (such as a medical instrument, transportation equipment, aerospace machinery, nuclear-reactor controller, fuel-controller or other safety device). ROHM shall bear no responsibility in any way for use of any of the Products for the above special purposes. If a Product is intended to be used for any such special purpose, please contact a ROHM sales representative before purchasing.

If you intend to export or ship overseas any Product or technology specified herein that may be controlled under the Foreign Exchange and the Foreign Trade Law, you will be required to obtain a license or permit under the Law.



Thank you for your accessing to ROHM product informations.
More detail product informations and catalogs are available, please contact us.

ROHM Customer Support System

<http://www.rohm.com/contact/>