

INTERNATIONAL RECTIFIER

INTERNATIONAL RECTIFIER 

T-39-19

HEXFET® TRANSISTORS

**P-CHANNEL
50 VOLT
POWER MOSFETs**

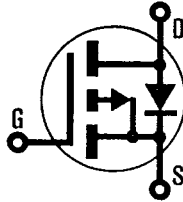

**IRF9Z20
IRF9Z22**

**-50 Volt, 0.28 Ohm, HEXFET
TO-220AB Plastic Package**

The HEXFET® technology is the key to International Rectifier's advanced line of power MOSFET transistors. The efficient geometry and unique processing of the HEXFET design achieve very low on-state resistance combined with high transconductance and extreme device ruggedness.

The P-Channel HEXFETs are designed for application which require the convenience of reverse polarity operation. They retain all of the features of the more common N-Channel HEXFETs such as voltage control, very fast switching, ease of paralleling, and excellent temperature stability.

P-Channel HEXFETs are intended for use in power stages where complementary symmetry with N-Channel devices offers circuit simplification. They are also very useful in drive stages because of the circuit versatility offered by the reverse polarity connection. Applications include motor control, audio amplifiers, switched mode converters, control circuits and pulse amplifiers.

Product Summary

Part Number	V _{DS}	R _{DS(on)}	I _D
IRF9Z20	-50V	0.28Ω	-9.7A
IRF9Z22	-50V	0.33Ω	-8.9A

Features:

- P-Channel Versatility
- Compact Plastic Package
- Fast Switching
- Low Drive Current
- Ease of Paralleling
- Excellent Temperature Stability

CASE STYLE AND DIMENSIONS

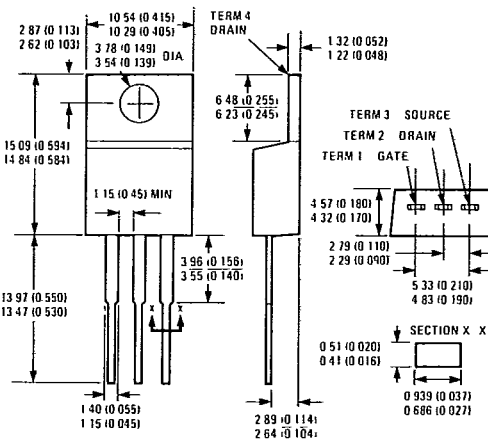
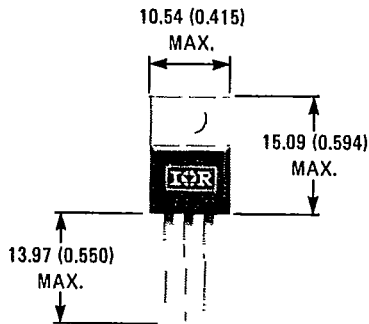

Case Style TO-220AB
Dimensions in Millimeters and (Inches)

Absolute Maximum Ratings

Parameter	IRF9Z20	IRF9Z22	Units
V _{DS} Drain - Source Voltage ①	-50	-50	V
V _{DGR} Drain - Gate Voltage (R _{GS} = 20 kΩ) ①	-50	-50	V
I _D @ T _C = 25°C Continuous Drain Current	-9.7	-8.9	A
I _D @ T _C = 100°C Continuous Drain Current	-6.1	-5.6	A
I _{DM} Pulsed Drain Current ②	-39	-36	A
V _{GS} Gate - Source Voltage	±20		V
P _D @ T _C = 25°C Max. Power Dissipation	40		W
Linear Derating Factor	0.32		W/K ③
i _{LM} Inductive Current, Clamped	-39 (See Fig. 14), L = 100μH	-36	A
i _L Unclamped Inductive Current (Avalanche Current) ③	(See Fig. 15) -2.2		A
T _J Operating Junction and Storage Temperature Range	-55 to 150		°C
T _{stg} Lead Temperature	300 (0.063 in. (1.6mm) from case for 10s)		°C

Electrical Characteristics @ T_C = 25°C (Unless Otherwise Specified)

Parameter	Type	Min.	Typ.	Max.	Units	Test Conditions
BV _{DSS} Drain - Source Breakdown Voltage	IRF9Z20 IRF9Z22	-50	-	-	V	V _{GS} = 0V I _D = -250 μA
V _{GS(th)} Gate Threshold Voltage	ALL	-2.0	-	-4.0	V	V _{DS} = V _{GS} , I _D = -250 μA
I _{GSS} Gate-Source Leakage Forward	ALL	-	-	-500	nA	V _{GS} = -20V
I _{GSS} Gate-Source Leakage Reverse	ALL	-	-	500	nA	V _{GS} = 20V
I _{DSS} Zero Gate Voltage Drain Current	ALL	-	-	-250 -1000	μA	V _{DS} = Max. Rating, V _{GS} = 0V V _{DS} = Max. Rating × 0.8, V _{GS} = 0V, T _C = 125°C
I _{D(on)} On-State Drain Current ④	IRF9Z20 IRF9Z22	-9.7 -8.9	-	-	A	V _{DS} > I _{D(on)} × R _{DS(on)max} , V _{GS} = -10V
R _{DS(on)} Static Drain-Source On-State Resistance ④	IRF9Z20 IRF9Z22	-	0.20 0.28	0.28 0.33	Ω	V _{GS} = -10V, I _D = -5.6A
g _{fs} Forward Transconductance ④	ALL	2.3	3.5	-	S(l)	V _{DS} = 2 × V _{GS} , I _{DS} = -5.6A
C _{iss} Input Capacitance	ALL	-	460	-	pF	V _{GS} = 0V, V _{DS} = -25V, f = 1.0 MHz
C _{oss} Output Capacitance	ALL	-	320	-	pF	See Fig. 10
C _{rss} Reverse Transfer Capacitance	ALL	-	58	-	pF	
t _{d(on)} Turn-On Delay Time	ALL	-	8.2	12	ns	V _{DD} = -25V, I _D ≈ -9.7A, R _G = 18Ω, R _D = 2.4Ω
t _r Rise Time	ALL	-	57	86	ns	See Fig. 16
t _{d(off)} Turn-Off Delay Time	ALL	-	12	18	ns	(MOSFET switching times are essentially independent of operating temperature.)
t _f Fall Time	ALL	-	25	38	ns	
Q _g Total Gate Charge (Gate-Source Plus Gate-Drain)	ALL	-	17	26	nC	V _{GS} = -10V, I _D = -9.7A, V _{DS} = 0.8 Max. Rating. See Fig. 17 for test circuit. (Gate charge is essentially independent of operating temperature.)
Q _{gs} Gate-Source Charge	ALL	-	4.1	6.2	nC	
Q _{gd} Gate-Drain ("Miller") Charge	ALL	-	5.7	8.6	nC	
L _D Internal Drain Inductance	ALL	-	4.5	-	nH	Measured from the drain lead, 6mm (0.25 in.) from package to center of die.
L _S Internal Source Inductance	ALL	-	7.5	-	nH	Measured from the source lead, 6mm (0.25 in.) from package to source bonding pad.

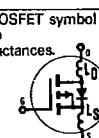

Thermal Resistance

Parameter	Units	Value	Notes
R _{thJC} Junction-to-Case	K/W ⑤	3.1	
R _{thCS} Case-to-Sink	K/W ⑤	1.0	Mounting surface flat, smooth, and greased.
R _{thJA} Junction-to-Ambient	K/W ⑤	80	Typical socket mount

Source-Drain Diode Ratings and Characteristics

I_S	Continuous Source Current (Body Diode)	IRF9Z20	-	-	-9.7	A	Modified MOSFET symbol showing the integral reverse P-N junction rectifier.
		IRF9Z20	-	-	-8.9	A	
I_{SM}	Pulse Source Current (Body Diode) ③	IRF9Z22	-	-	-39	A	
		IRF9Z22	-	-	-36	A	
V_{SD}	Diode Forward Voltage ②	ALL	-	-	-6.3	V	$T_C = 25^\circ\text{C}, I_S = -9.7\text{A}, V_{GS} = 0\text{V}$
t_{rr}	Reverse Recovery Time	ALL	56	110	280	ns	$T_J = 25^\circ\text{C}, I_F = -9.7\text{A}, dI_F/dt = 100\text{A}/\mu\text{s}$
Q_{RR}	Reverse Recovered Charge	ALL	0.17	0.34	0.85	μC	$T_J = 25^\circ\text{C}, I_F = -9.7\text{A}, dI_F/dt = 100\text{A}/\mu\text{s}$
t_{on}	Forward Turn-on Time	ALL	Intrinsic turn-on time is negligible. Turn-on speed is substantially controlled by $L_S + L_D$.				

① $T_J = 25^\circ\text{C}$ to 150°C ② Repetitive Rating: Pulse width limited by max. junction temperature. See Transient Thermal Impedance Curve (Fig. 5).
 ③ @ $V_{dd} = -25\text{V}, T_J = 25^\circ\text{C}$ ④ Pulse Test: Pulse width $\leq 300 \mu\text{s}$, Duty Cycle $\leq 2\%$
 ⑤ $K/W = ^\circ\text{C}/\text{W}$ $L = 100 \mu\text{H}, R_G = 25\Omega$

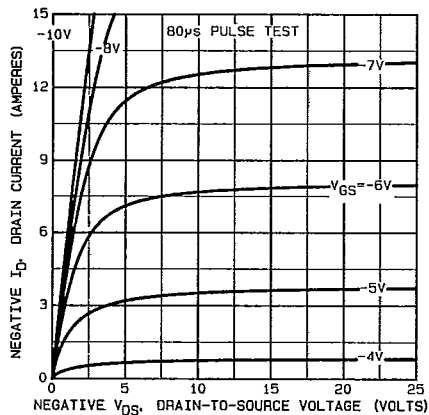

Fig. 1 — Typical Output Characteristics

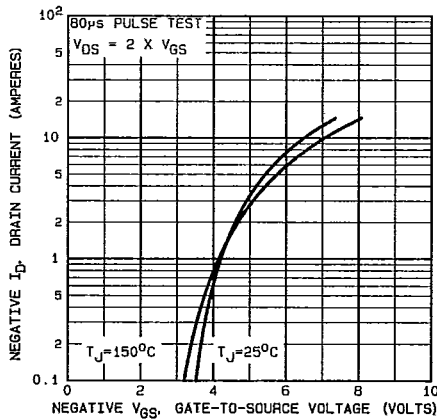

Fig. 2 — Typical Transfer Characteristics

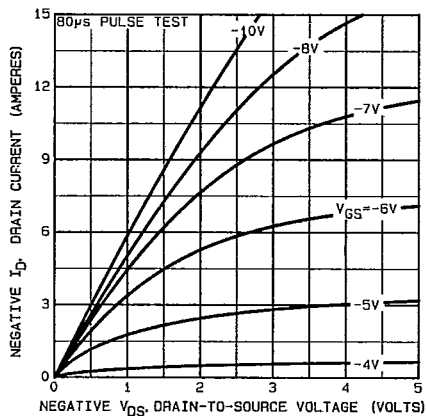

Fig. 3 — Typical Saturation Characteristics

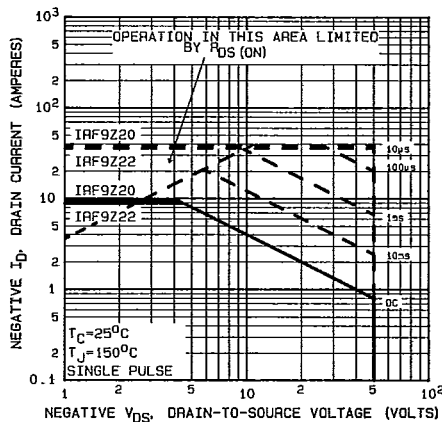

Fig. 4 — Maximum Safe Operating Area

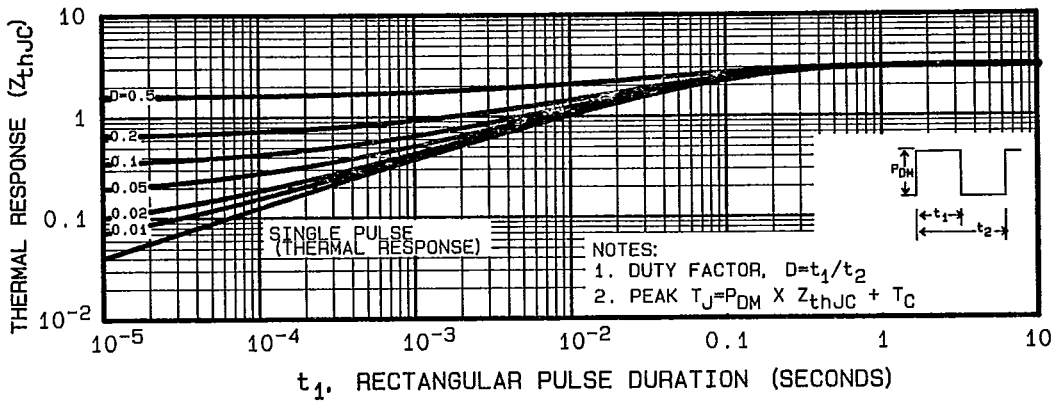

Fig. 5 — Maximum Effective Transient Thermal Impedance, Junction-to-Case Vs. Pulse Duration

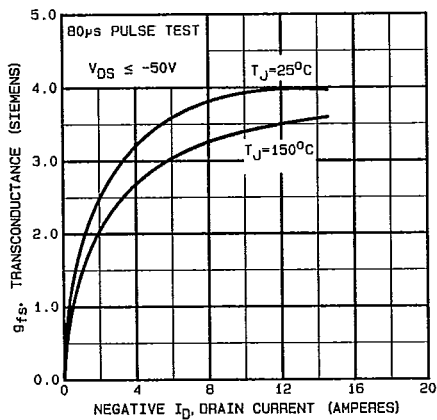

Fig. 6 — Typical Transconductance Vs. Drain Current

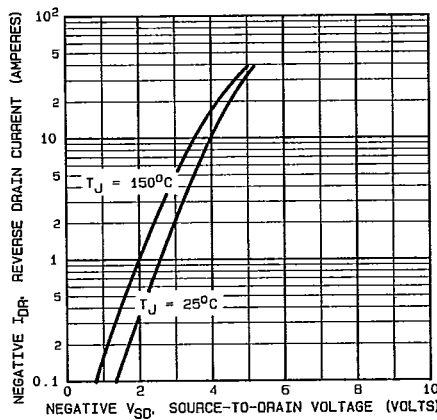

Fig. 7 — Typical Source-Drain Diode Forward Voltage

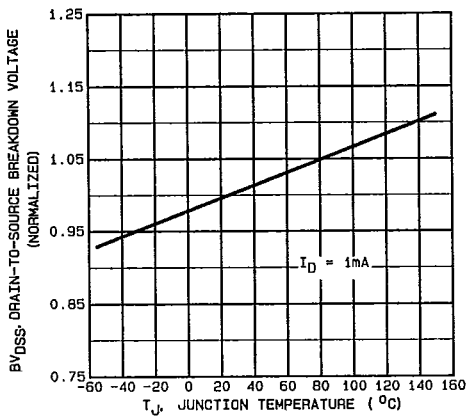

Fig. 8 — Breakdown Voltage Vs. Temperature

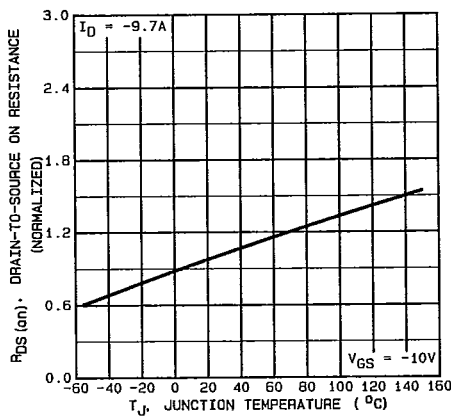

Fig. 9 — Normalized On-Resistance Vs. Temperature

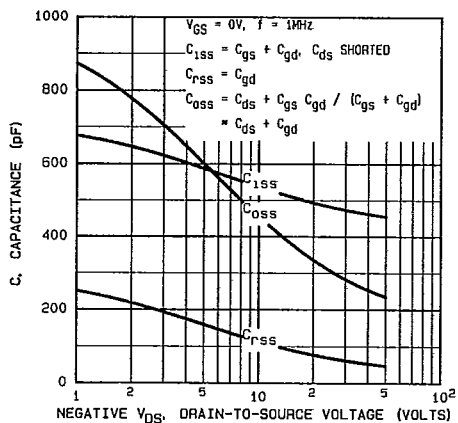

Fig. 10 — Typical Capacitance Vs. Drain-to-Source Voltage

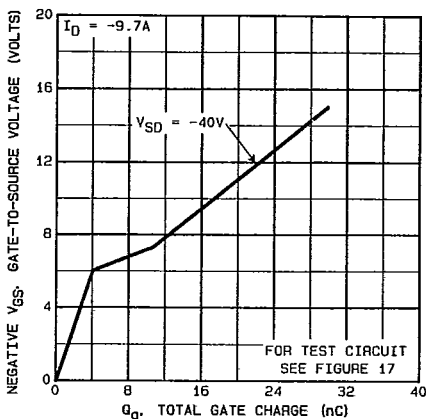

Fig. 11 — Typical Gate Charge Vs. Gate-to-Source Voltage

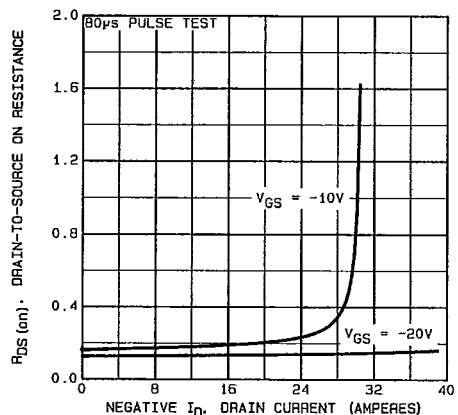

Fig. 12 — Typical On-Resistance Vs. Drain Current

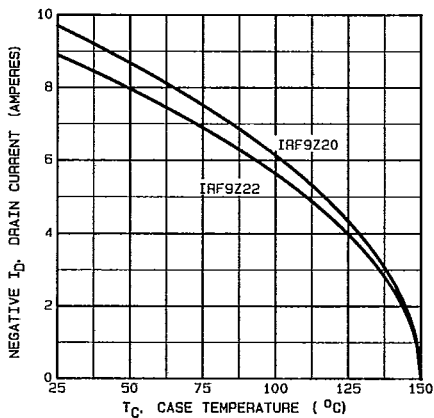

Fig. 13 — Maximum Drain Current Vs. Case Temperature

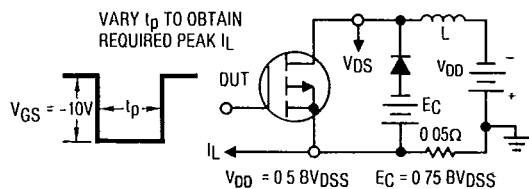

Fig. 14a — Clamped Inductive Test Circuit

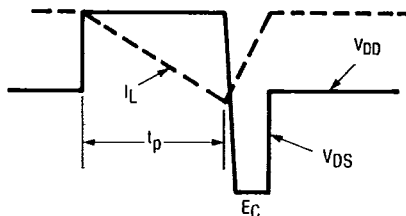

Fig. 14b — Clamped Inductive Waveforms

IRF9Z20, IRF9Z22 Devices

11E D 4855452 0008635 2

INTERNATIONAL RECTIFIER

T-39-19

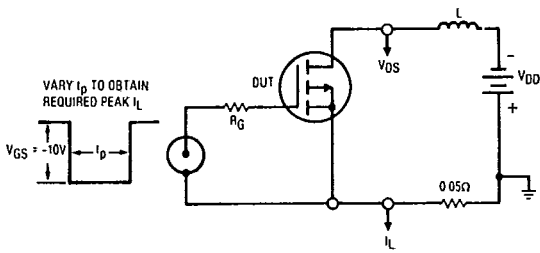

Fig. 15a — Unclamped Inductive Test Circuit

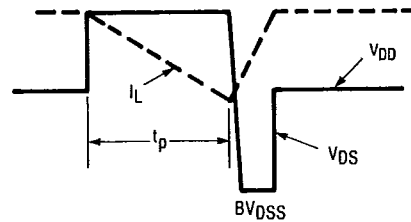

Fig. 15b — Unclamped Inductive Load Test Waveforms

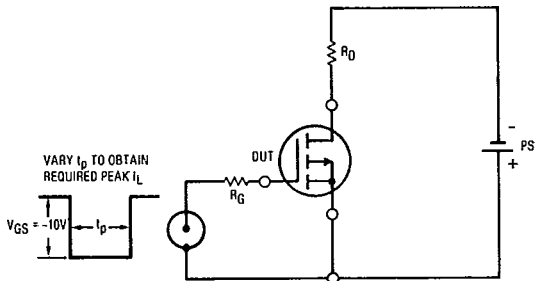

Fig. 16 — Switching Time Test Circuit

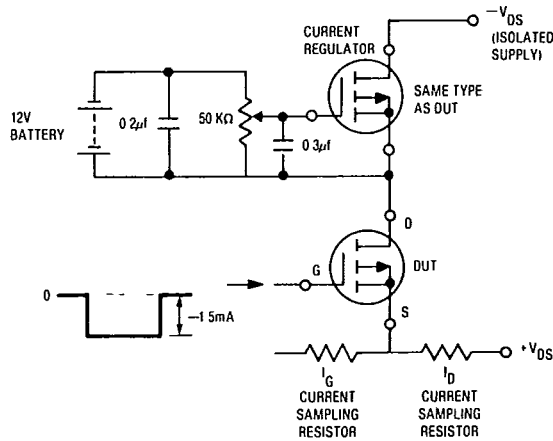
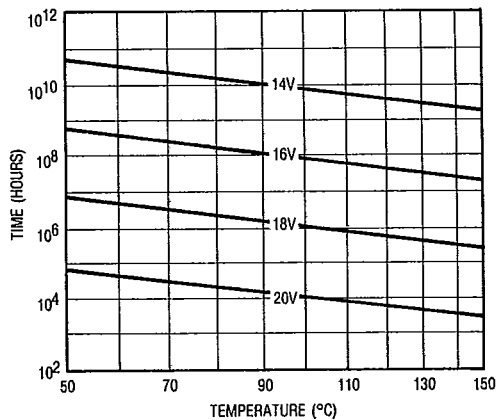
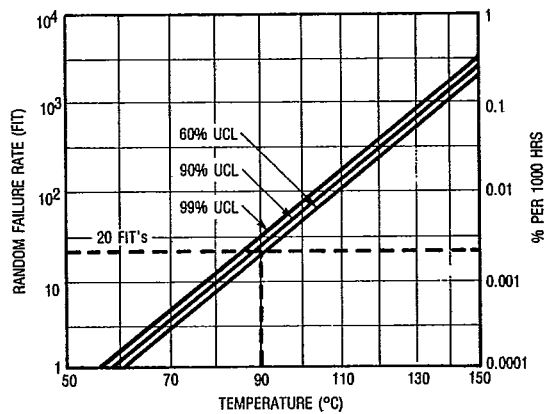

Fig. 17 — Gate Charge Test Circuit



*Fig. 18 — Typical Time to Accumulated 1% Gate Failure



*Fig. 19 — Typical High Temperature Reverse Bias (HTRB) Failure Rate

*The data shown is correct as of April 15, 1987. This information is updated on a quarterly basis; for the latest reliability data, please contact your local IR field office.