

MC1307P

DEVICE DISCONTINUED – CONSULT FACTORY

MONOLITHIC FM MULTIPLEX STEREO DEMODULATOR

... designed to derive the left and right channel audio information from the detected composite signal.

- Capable of Operation Over a Wide Power Supply Range – 8.0 – 14 Vdc
- Built-in Stereo-Indicator Lamp Driver

FM MULTIPLEX STEREO DEMODULATOR SILICON MONOLITHIC INTEGRATED CIRCUIT

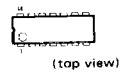

PLASTIC PACKAGE
CASE 646

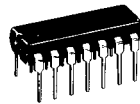
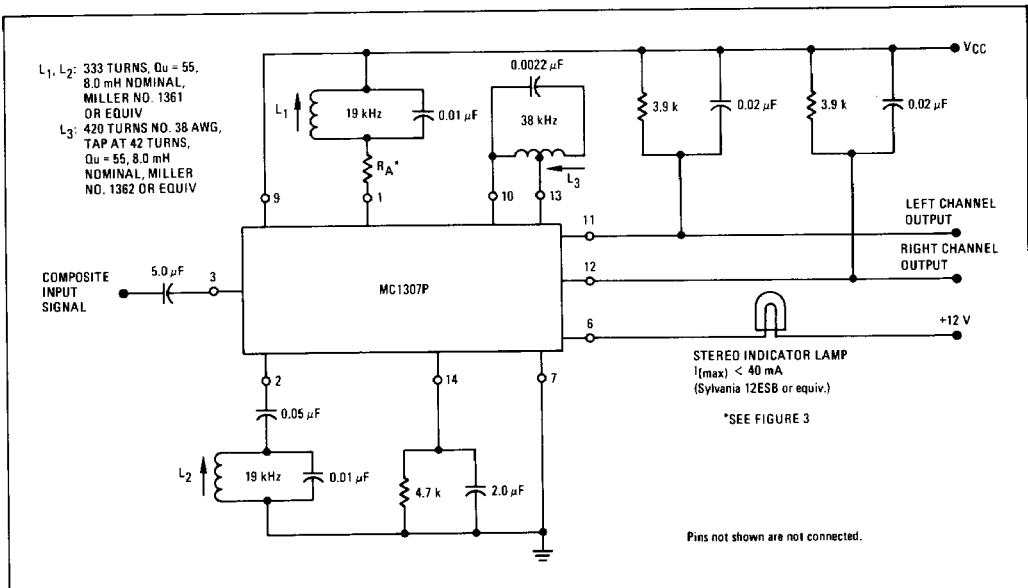

FIGURE 1 – TYPICAL CIRCUIT CONFIGURATION



TYPICAL DC VOLTAGES (All measured using a VTVM with respect to Pin 7 (lamp on), $R_A = 180$ ohms, see Figure 3)

Pin Numbers	1	2	3	4	5	6	7	8	9	10	11	12	13	14
$V_{CC} = 8.5$ Vdc	8.5	2.7	3.6	—	—	0.8	0	—	8.5	4.4	6.2	6.2	4.4	1.5
$V_{CC} = 12$ Vdc	12	2.9	3.9	—	—	0.9	0	—	12	4.7	9.7	9.7	4.7	1.7

See Packaging Information Section for outline dimensions.

FIGURE 2 – CIRCUIT SCHEMATIC

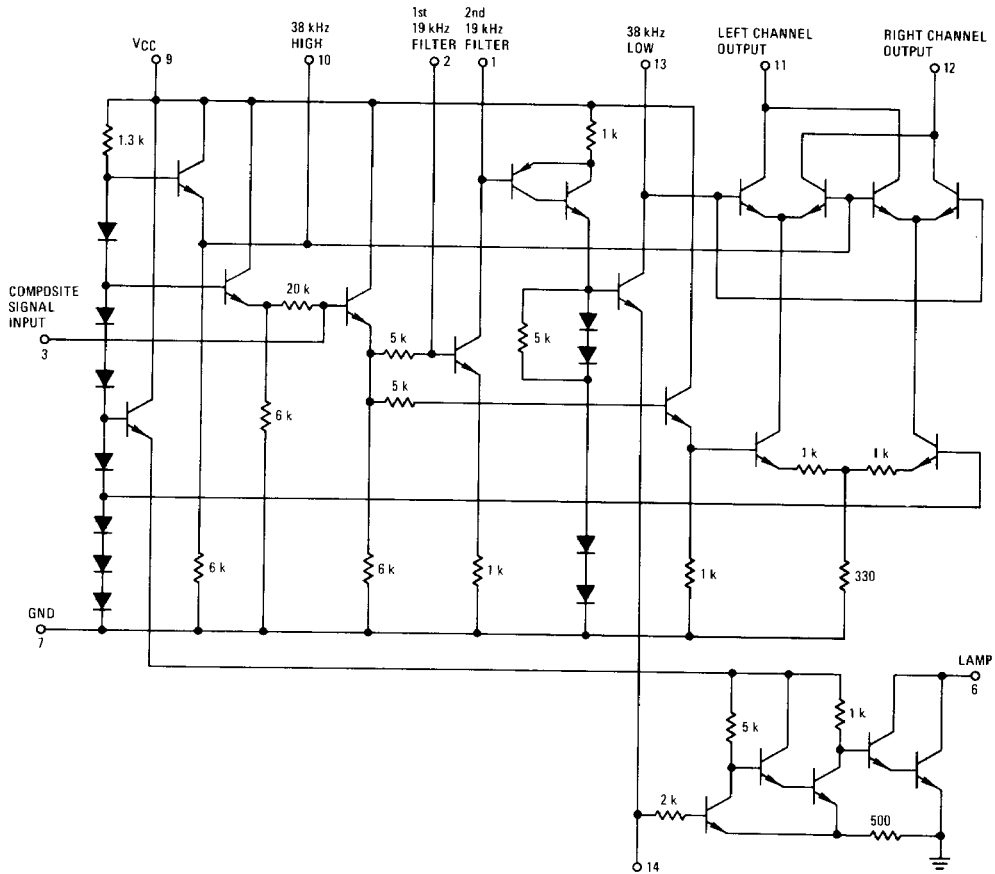

MAXIMUM RATINGS ($T_A = +25^{\circ}\text{C}$ unless otherwise noted.)

Rating	Value	Unit
Power Supply Voltage (Pins 1, 6, 9, 11, 12) (Pin 7 is grounded)	+22	Vdc
Lamp Driver Current	40	mA _{dc}
Power Dissipation (Package Limitation) Derate above $T_A = +25^{\circ}\text{C}$	625	mW
Operating Temperature Range (Ambient)	0 to +75	$^{\circ}\text{C}$
Storage Temperature Range	-65 to +150	$^{\circ}\text{C}$

www.DataS

MC1307P (continued)

ELECTRICAL CHARACTERISTICS ($V_{CC} = 12 \text{ Vdc}$, $T_A = +25^\circ\text{C}$, tests made with a $75 \mu\text{s}$ de-emphasis network ($3.9 \text{ k}\Omega$, $0.02 \mu\text{F}$) unless otherwise noted.)

Characteristic	Min	Typ	Max	Unit
Input Impedance ($f = 1.0 \text{ kHz}$)	12	20	—	$\text{k}\Omega$
Stereo Channel Separation (See Note 1) ($f = 100 \text{ Hz}$) ($f = 1.0 \text{ kHz}$) ($f = 10 \text{ kHz}$)	— 20 —	35 40 30	— — —	dB
Total Harmonic Distortion (See Notes 1 and 2) (Modulation Frequency = 1.0 kHz)	—	0.5	1.0	%
Channel Balance (Monaural Input = 200 mV [rms]) (Monaural, Left and Right Outputs)	—	0.5	—	dB
Ultrasonic Frequency Rejection (See Note 3) (19 kHz) (38 kHz)	— —	25 20	— —	dB
Inherent SCA Rejection (without filter) ($f = 60 \text{ kHz}$, 67 kHz and 74 kHz) (See Note 3)	—	50	—	dB
Lamp Indicator ($R_A = 180 \Omega$) (Minimum 19 kHz input level for lamp "on") (Maximum 19 kHz input level for lamp "off")	— 5.0	16 14	25 —	mV (rms)
Power Dissipation ($V_{CC} = 12 \text{ V}$) (Without lamp) (With lamp)	— —	140 170	300 300	mW

Note 1 — Measurement made with 200 mV (rms) Standard Multiplex Composite Signal where $L = 1$, $R = 0$ or $R = 1$, $L = 0$. Standard Multiplex Composite Signal is here defined as a signal containing left and/or right audio information with a 10% (19 kHz) pilot signal in accordance with FCC regulations.

Note 2 — Distortion specification also applies to Monaural Signal.

Note 3 — Referenced to 1.0 kHz output signal with Standard Multiplex Composite Input Signal.

TYPICAL CHARACTERISTICS

FIGURE 3 — DISTORTION COMPONENTS IN AUDIO SIGNAL

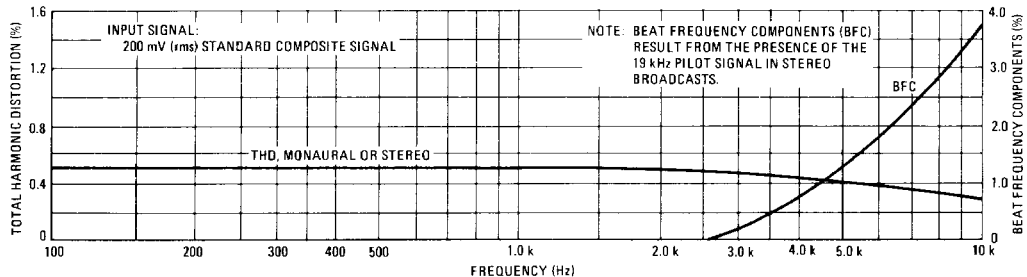

TYPICAL CHARACTERISTICS (continued)

FIGURE 4 – TOTAL HARMONIC DISTORTION

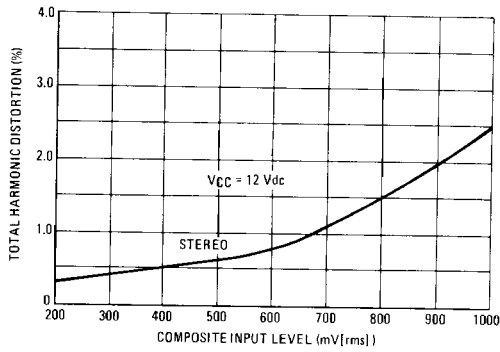

FIGURE 5 – MULTIPLEX SENSITIVITY

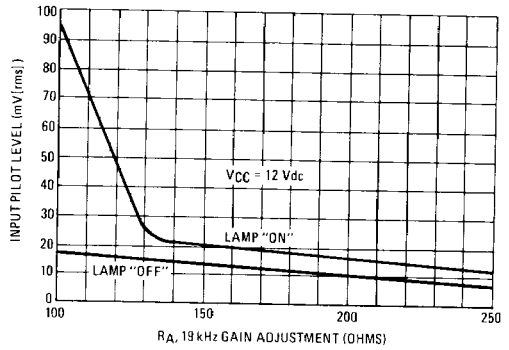

FIGURE 6 – CHANNEL SEPARATION

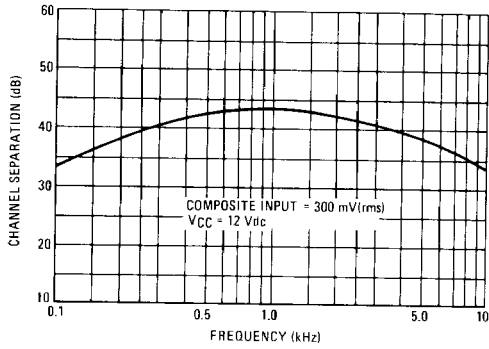

FIGURE 7 – CHANNEL SEPARATION

