

# KENWOOD

DPC-MP727  
DPC-MP922

PORTABLE COMPACT DISC PLAYER

## INSTRUCTION MANUAL

Note:  
This instruction manual is for common use with the 2 models above.

### Unpacking

Unpack the unit carefully and make sure that all accessories are put aside so they will not be lost.

Examine the unit for any possibility of shipping damage. If your unit is damaged or fails to operate, notify your dealer immediately. If your unit was shipped to you directly, notify the shipping company without delay. Only the consignee (the person or company receiving the unit) can file a claim against the carrier for shipping damage.

We recommend that you retain the original carton and packing materials for use should you transport or ship the unit in the future.

### Before using the rechargeable batteries

The rechargeable batteries comes non-charged condition. Read "Recharging the batteries" carefully and charge the batteries before use.

In addition to normal audio CDs (CD-DA), this equipment is capable of playing back media on which MP3 and WMA files have been stored.



KENWOOD CORPORATION

## Specifications

### Standards

Signal reading format ..... Non-contact signal reading (semi-conductor laser)

### Characteristics

Frequency characteristics ..... 20Hz to 20kHz, +/-3dB  
Headphone output (16 Ω, 1kHz) ..... 9mW + 9mW  
LINE OUT output level/impedance ..... MAX 0.85V/10k

### Power supply

External DC supply ..... DC 4.5 to 5.1V  
Size AA alkaline batteries available on the open market (LR6/AA x 2 or 4) ..... DC 3V  
Rechargeable batteries (NB-150 x 2) ..... DC 2.4V

Maximum external dimensions (width x height x depth) ..... 129mm x 32mm x 138mm  
(5-1/16" x 1-1/4" x 5-7/16")

Weight (net) ..... 260g (0.6lb)

### Battery life expectancy (during continual repeated playback)

Battery	When D.A.S.C. is off	When D.A.S.C. is on	During MP3/WMA file playback
Size AA alkaline batteries available on the open market (LR6/AA x 2)	Approximately 9 hours	Approximately 10 hours	Approximately 10 hours
Size AA alkaline batteries available on the open market (LR6/AA x 4)	Approximately 18 hours	Approximately 22 hours	Approximately 22 hours
Rechargeable battery (NB-150 x 2)	Approximately 7 hours	Approximately 8 hours	Approximately 8 hours

### Note:

KENWOOD follows a policy of continuous advancements in development. For this reason specifications may be changed without notice.

### Accessories

The accessories marked by an asterisk (\*) are provided only for some areas.

Details	DPC-MP727	DPC-MP922
AC adapter	1	1
Headphones	1	1
Remote controller (Except for U.S.A., Canada and Australia)	*1	—
Rechargeable batteries (Except for U.S.A., Canada, U.K. and Europe)	*1 pair	—
External battery case	1	1
Battery carrying case (Except for U.S.A., Canada, U.K. and Europe)	*1	—
Car cassette adapter (CAC-3A)	—	1
Car battery adapter	—	1
AC plug adapter (Except for U.S.A., Canada, Australia, U.K. and Europe)	*1	—

The standard accessories vary depending on the model of the unit. The accessories which are not standard are optionally available. For details, please consult your dealer.

## KENWOOD

### For your records

Record the serial number, found on the back of the unit, in the spaces designated on the warranty card, and in the space provided below. Refer to the model and serial numbers whenever you call upon your dealer for information or service on this product.

Model \_\_\_\_\_ Serial Number \_\_\_\_\_

## Media that can be played back with this equipment

### Usable media apart from audio CDs (CD-DA)

Usable media : CD-ROM, CD-R, CD-RW  
Usable formats : ISO9660 level 1 and level 2 (excluding expanded formats)  
Files that can be played back: MP3 and WMA files

## Creating media for playing back on this equipment

### Compressing MP3 and WMA files

Please set up the transfer bit rate setting for the compression software when compressing MP3 and WMA files as follows:

MP3 Files : 128kbps recommended (32kbps-320kbps)  
WMA Files : 128kbps recommended (64kbps-160kbps)

- This unit is compatible with 32kHz, 44.1kHz (recommended) and 48kHz sampling frequencies.

### Categorizing folders

As MP3 and WMA files are compressed into high-quality sound files at an extremely high rate of compression, it is possible to record several times more tracks than audio CDs onto a single medium. It is therefore convenient to split the tracks into different folders by genre, artist or album for retrieval and repeat playback purposes.

- A maximum of 23 folders or a maximum of 200 files can be stored on a single media.
- There are cases where it is not possible to save folders in the desired sequence depending on the software being used.

### Naming files

Single-byte characters between A and Z, single-byte numerals between 0 and 9, and the single-byte underscore (\_) can be used when naming files. A maximum of twelve characters can be displayed. Ensure that the ".MP3" (MP3 files) or ".WMA" (WMA files) extension logs are attached to all file names.

- Never add the MP3 or WMA extension logs to any files other than MP3 and WMA files. If the MP3 or WMA extension logs are added to any files other than MP3 and WMA files, the equipment will assume that they can be played back, and this will produce loud noises in the headphones, resulting in damage of adverse effects.

### Hint for when naming folders and files

When media containing MP3 and WMA files are played back on this equipment, the sequence in which each track is played back will be the same as the sequence in which they were saved. It is possible to set up the playback sequence by adding numbers from between 01 and 99 to the front of the folder and the file name when saving the file.

- There are cases where it is not possible to save files in the desired sequence depending on the software being used.

### Additional information

Depending on the MP3 and WMA compression software in use, it is possible to save track titles, artist names and other information together with each sound file as additional information.

Although it is possible to display pre-recorded title and artist information with this information, it is necessary to ensure that this information has been entered in single-byte alphanumeric characters (Up to a maximum of 30 alphanumeric characters for each.).

- The method of entering title and artist information will differ in accordance with the compression software. Refer to the compression software's instruction manual or help file.

### Confirming media and files

Check to ascertain that MP3 and WMA files can be played back correctly on the personal computer in use prior to saving them onto the media. Check to ensure that the saved file can be played back normally.

- It is not possible to confirm that files can be played back correctly while they are being saved onto the media.

### When saving files onto media

Ensure that the session is closed or finalized when data has been written on media. There are cases where media on which the session has not been closed or finalized will not be played back correctly with this equipment.

- There are cases where the folder names and file names will not be displayed correctly depending on the software used to save them.
- Do not store files or folders other than MP3 and WMA on media to be played back with this equipment.
- It is recommended that ten or less sessions are stored when recording MP3 and WMA files onto a medium.
- There are cases where playback is not possible when MP3 and WMA files (CD-ROM) and music CD information (CD-DA) are saved on the same media.

## Safety precautions

⚠ Caution: Read this page carefully to ensure safe operation.

**WARNING: TO PREVENT FIRE OR ELECTRIC SHOCK, DO NOT EXPOSE THIS APPLIANCE TO RAIN OR MOISTURE.**

## IMPORTANT SAFEGUARDS

Please read all of the safety and operating instructions before operating this unit. For best results, follow all warnings placed on the unit and adhere to the operating and use instructions. These safety and operating instructions should be retained for future reference.

- Power sources** — The unit should be connected to a power supply only of the type described in the operating instructions or as marked on the appliance.
- Power-cord protection** — Power-supply cords should be routed so that they are not likely to be walked on or pinched by items placed upon or against them. Pay particular attention to cords at plugs, convenience receptacles, and the point where they exit from the unit.
- Enclosure removal** — Never remove the enclosure. If the internal parts are touched accidentally, a serious electric shock might occur.
- Drop** — Do not drop the unit or apply strong shock to it. (Damage due to dropping the unit is not covered by the warranty.)
- Ventilation** — Avoid hindering the ventilation of the unit by covering it with a cloth, etc.
- Abnormal smell** — If an abnormal smell or smoke is detected, immediately turn the power OFF and pull out the power cord. Contact your dealer or nearest service center.
- Heat** — Avoid placing the unit under direct sunlight or near a source of heat such as heating equipment. Particularly, never leave it in an automobile or on the dashboard.
- Temperature** — The unit may not function properly if used at extremely low, or freezing temperatures. The ideal ambient temperature is above +5°C (41°F).
- Water and moisture** — The unit should not be used near water — for example, near a bathtub, washbowl, kitchen sink, laundry tub, in a wet basement, or near a swimming pool, etc.
- Dust and moisture** — Avoid places where is dusty or where the humidity is high.
- Vibrations** — Avoid placing the unit on an unstable place such as a shelf or in a place subject to vibrations.
- Magnetic fields** — Keep the unit away from sources of magnetic fields such as TV sets, speaker systems, radios, motorized toys or magnetized objects.
- Cleaning** — Do not use volatile solvents such as alcohol, paint thinner, gasoline, or benzene, etc. to clean the cabinet. Use a clean dry cloth.
- Nonuse periods** — The power cord of the unit should be unplugged from the outlet when left unused for a long period of time.
- Damage requiring service** — The unit should be serviced by qualified service personnel when:
  - The power-supply cord or the plug has been damaged.
  - Objects have fallen, or liquid has been spilled into the unit.
  - The unit has been exposed to rain.
  - The unit does not appear to operate normally or exhibits a marked change in performance.
  - The unit has been dropped, or the enclosure damaged.
- Servicing** — The user should not attempt to service the unit beyond that described in the operating instructions. All other servicing should be referred to qualified service personnel.
- CAUTION** — TO PREVENT ELECTRIC SHOCK DO NOT USE THE AC PLUG WITH AN EXTENSION CORD, RECEPTACLE OR OTHER OUTLET UNLESS THE BLADES CAN BE FULLY INSERTED TO PREVENT BLADE EXPOSURE.

### Notes on using through car stereo

- In case of abnormality such as smoke production, immediately unplug the car battery adapter from the cigar lighter socket.
- Do not leave the products or batteries in the car, particularly above the dashboard, for this may lead to malfunction or damage due to solar heat.
- If the unit is connected to a car stereo using an audio cord, noise may sometimes interfere.

## Before applying power

⚠ Caution: Read this page carefully to ensure safe operation.

### AC adaptors are designed for operation as follows.

U.S.A. and Canada ..... AC 120 V only  
Australia ..... AC 240 V only  
Europe and U.K. .... AC 230 V only  
\*Other countries ..... AC 110-120 / 220 -240 V switchable

### For the U.S.A.

#### FCC WARNING:

This equipment may generate or use radio frequency energy. Changes or modifications to this equipment may cause harmful interference unless the modifications are expressly approved in the instruction manual. The user could lose the authority to operate this equipment if an unauthorized change or modification is made.

#### NOTE:

This equipment has been tested and found to comply with the limits for a CLASS B digital device, pursuant to Part 15 of the FCC Rules. These limits are designed to provide reasonable protection against harmful interference in a residential installation. This equipment may cause harmful interference to radio communications, if it is not installed and used in accordance with the instructions. However, there is no guarantee that interference will not occur in a particular installation. If this equipment does cause harmful interference to radio or television reception, which can be determined by turning the equipment off and on, the user is encouraged to try to correct the interference by one or more of the following measures:

- Reorient or relocate the receiving antenna.
- Increase the separation between the equipment and receiver.
- Connect the equipment into an outlet on a circuit different from that to which the receiver is connected.
- Consult the dealer or an experienced radio/TV technician for help.

### For CANADA

#### NOTICE:

This Class B digital apparatus complies with Canadian ICES-003.

### \*For other countries

#### AC voltage selection

This unit operates on 110-120 or 220-240 AC voltage. The AC voltage selector switch on the AC adapter is set to the voltage that prevails in the area to which the unit is shipped. Before connecting the power cord to your AC outlet, make sure that the setting position of this switch matches your line voltage. If not, it must be set to your voltage in accordance to the following direction.

#### Note:

Our warranty does not cover damage caused by excessive line voltage due to improper setting of the AC voltage selector switch.

#### AC voltage selector switch

Move switch lever to match your line voltage with a small screwdriver or other pointed tool.

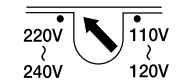

The marking of products using lasers (Except for some areas).

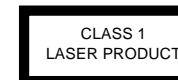

The marking is located on the bottom side says that this product has been classified as Class 1. It means that there is no danger of hazardous radiation outside the product.

## Part names

### Player

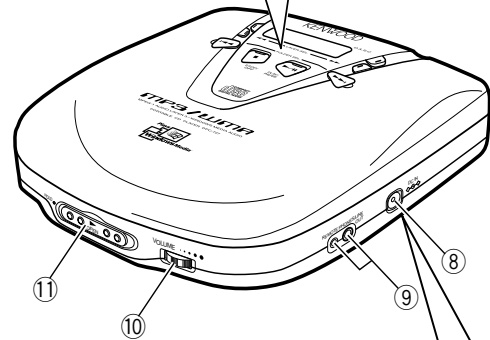
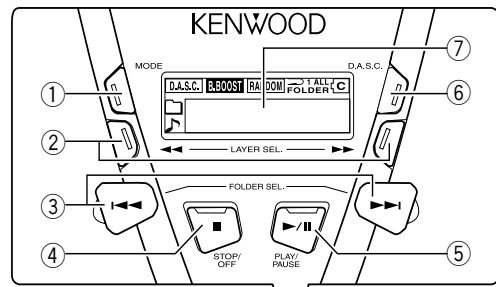

#### Using the AC adapter\*

Do not use anything other than the AC adapter supplied.

- Note that the power will be switched off when the cable is plugged in or unplugged from the player's DC IN terminal.

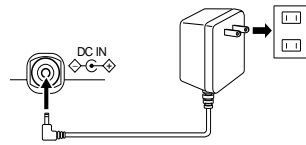

\* Shape of AC adapter may differ depending on the sales area.

- MODE key**  
Used to switch between the playback mode, the display mode and other modes.
- ◀▶ keys**  
Used for fast forward and fast reverse, and to select folders.
- ◀▶ keys**  
Used to search the beginning of tracks, to set up the various modes, and to select folders.
- STOP/OFF key**  
Used to stop, to switch off the power supply, and to recharge the batteries.
- PLAY/PAUSE key**  
Used for playback, pausing, and to switch on the power supply.
- D.A.S.C. (Digital Anti-Shock Circuit) key**  
Used to switch across to the sound skip guard function.
- Liquid crystal display**
- DC IN (external power supply terminal)**  
Used for connecting the AC adapter supplied.  
Used for connecting the car battery adapter when using a car battery for playback purposes.
- REMOTE PHONES/LINE OUT terminals**  
Used for connecting the remote controller or headphones supplied.  
Used for connecting an amplifier or speakers built into amplifiers when used as a LINE OUT terminal.  
Used for connecting the car cassette adapter when using for playing back car audio units.
- VOLUME knob**  
Used to adjust the volume.
- OPEN/HOLD switch**  
Used when the top cover is to be opened and when switching the hold function between on and off.

### Liquid crystal display

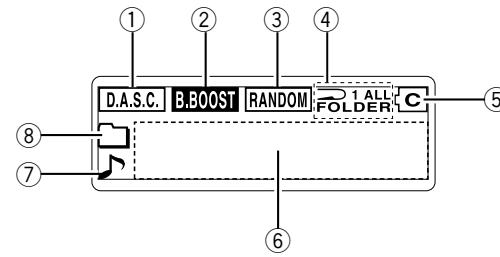

- D.A.S.C. display**  
Illuminated when the sound skip guard function is on.
- B.BOOST display**  
Illuminated when the bass tones have been boosted.
- RANDOM display**  
Illuminated when random playback has been selected.
- Repeat display**  
Illuminated when repeat playback has been selected.
- Battery display**  
Illuminated when the batteries are being recharged.
- Information display area**  
Displays track numbers, amount of time elapsed, titles and other disc information, and the status of the equipment.
- ♪ mark**  
Illuminated if files that can be played back are contained within the selected folder when media on which MP3 and WMA files are stored has been inserted into the player (blinks during folder selection).
- 📁 mark**  
Illuminated if other folders are contained within the selected folder when media on which MP3 and WMA files are stored has been inserted into the player (blinks during folder selection).

### Remote controller (DPC-MP727) (Except for U.S.A., Canada and Australia)

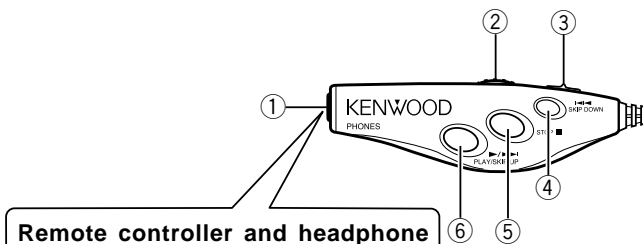

#### Remote controller and headphone connections

- The headphones are connected to the PHONES terminal on the remote controller. The headphones can also be connected directly to the player when the remote controller is disconnected.

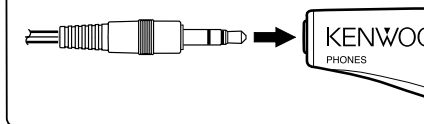

- PHONES terminal**  
Used to connect the headphones.
- VOLUME knob**  
Used to adjust the volume.
- HOLD switch**  
Used to switch the hold function between on and off.
- ◀◀ key (SKIP DOWN)**  
Used for searching for the beginning of tracks, etc.
- STOP ■ key**  
Used to stop the player and switch off the power.
- ▶▶ key (PLAY/SKIP UP)**  
Used for playing and searching for the beginning of tracks, etc.

## Inserting and recharging the batteries

### Inserting the batteries in the player

- Open the cover.**
- Taking care over the positive (+) and negative (-) poles, insert the batteries.**  
Insert from the positive (+) side.
  - When running the player on normal dry-cell batteries, use size AA alkaline batteries (LR6) available on the open market.
  - As playback time will be greatly reduced when manganese batteries are used, ensure that size AA alkaline batteries are used.
  - Make sure that both batteries are replaced when changing batteries.
  - Do not use rechargeable batteries and size AA alkaline batteries together.
- Close the cover.**

### Using the external battery case

Using the battery case together with the rechargeable batteries or size AA alkaline batteries set in the player will provide extended periods of continual play.

- Remove the cover on the battery case.**
- Taking care over the positive (+) and negative (-) poles, insert the size AA alkaline batteries.**
  - It is not possible to recharge the batteries with the external battery case.
  - As playback time will be greatly reduced when manganese batteries are used, ensure that size AA alkaline batteries are used.
  - Make sure that both batteries are replaced when changing batteries.
- Close the cover.**
- Attach the case to the player.**

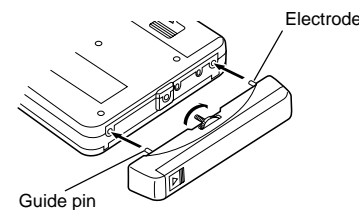

#### Caution:

Remove the battery case from the player when it is not to be used for long periods of time. As the dry-cell batteries will recharge the rechargeable batteries, the dry-cell batteries will run out quickly. Also, ensure that the batteries are removed from the case.

### Recharging the batteries

Refer to the "Accessories" table.

- Ensure that only the rechargeable batteries supplied with the player (NB-150) or sold separately (NB-130) are used. Batteries other than special Kenwood batteries must not be used under any circumstances.
- Remove the external battery case.

- Insert the rechargeable batteries in the player, and then connect the AC adapter.**
- Switch the power off.**
- Wait for five seconds, press the STOP key twice in succession, and then confirm that the symbol is illuminated.**



- The recharge timer will be switched off after approximately six hours. The power will be switched off once recharging is complete.

- Disconnect the AC adapter from the player once recharging is complete.**

## Avoiding miss-operations

It is possible to avoid miss-operations when the player is placed in a bag with the use of the hold function that prevents all keys, with the exception of special keys, from being operated.

#### Player:

Slide the OPEN/HOLD key to the HOLD position.

When on hold:



When the hold is cancelled:



- All keys on the player, with the exception of the OPEN/HOLD switch and the volume knob, will stop operating.
- Slide the OPEN/HOLD switch to the central position to cancel the hold function and resume operations.
- The operation keys on the remote control will not be set in the hold mode when the OPEN/HOLD switch on the player is set in the HOLD position.

#### Remote controller (DPC-MP727):

Slide the HOLD switch to the HOLD position.

When on hold:

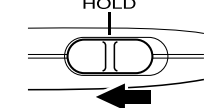

When the hold is cancelled:

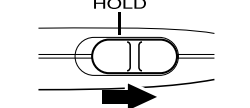

- All keys on the remote controller, with the exception of the volume knob, will stop operating.
- Slide the HOLD key to the off position to cancel the hold function and resume operations.

## Sound skip guard function (D.A.S.C.)

Sound skipping caused by vibrations, etc., is prevented by recording the sound data into the memory and then playing it back from the memory. The D.A.S.C. function will always be activated with MP3 and WMA files (approximately 110 seconds when saved with a transmission bit rate of 128kbps and a sampling frequency of 44.1kHz).

### Sound skip guard function mechanism

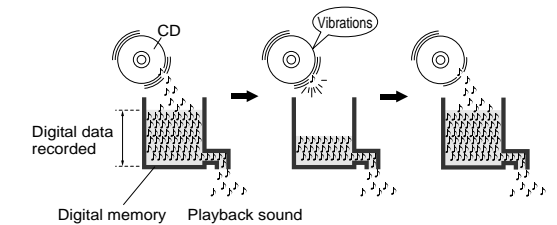

- There are cases where, depending on the degree of the vibrations, the memory data will be used up and the sound skip guard function will be temporarily disabled.

### D.A.S.C. setup (Audio CDs (CD-DA) only)

Press the D.A.S.C. key.

The display will alternate between the following whenever the key is pressed.

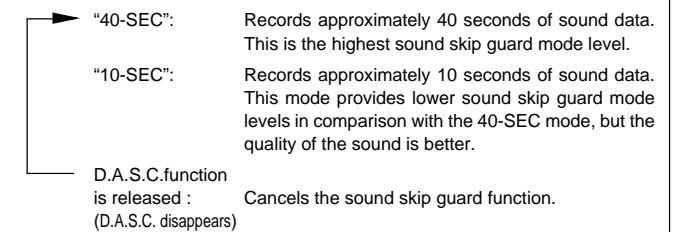

- Sound being played back will be cut off when switching between modes.
- The D.A.S.C. setting will become 40-SEC when the top cover is opened.

## Loading disc

- 1 Slide the OPEN/HOLD switch in the direction of the arrow to open the top cover.



- 2 Load the disc.

Ensure that the side with the label is facing upwards.

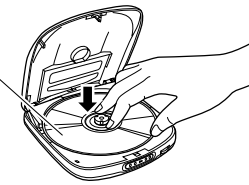

- Press the area around the hole until the central axis clicks into place.

- 3 Close the top cover.

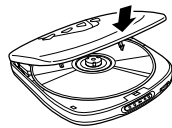

- Press the front of the cover in the center until it clicks firmly into place.

## Playing back audio CDs (CD-DA)

### Sequentially from the first track.

- 1 Check to ascertain that the OPEN/HOLD switch is set in the central position.

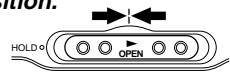

- The hold function is cancelled when the OPEN/HOLD switch is in the central position. Ensure that the hold function has been cancelled when operating the player with the use of player keys.

- 2 Press the PLAY/PAUSE key.

- The power supply will be switched on and playback will commence from the first track.
- The same operations can be performed by pressing the ►►► key on the remote controller.

- 3 Turn the VOLUME knob to adjust the volume.

- The volume knob on the remote controller is not interlinked with the volume level of the player. The volume to which the player has been adjusted will be effective when the volume on the remote controller has been turned up full.

### Searching for the beginning of tracks

#### Press the ◀◀◀ or ▶▶▶ keys.

▶▶▶: Press to select the next track.  
◀◀◀: Press to select the previous track.

- The beginning of the required track will be located in accordance with the number of times the keys are pressed.
- Press the ◀◀◀ key once during playback to return to the beginning of the track.
- The same operations can be performed by pressing the ◀◀◀ or ▶▶▶ keys on the remote controller.

### Fast forward/fast reverse

#### Player only:

Press the ►►► (fast forward) or ◀◀◀ (fast reverse) keys continuously during playback.

- Playback will recommence from the place the key is released.
- High-speed fast forward and fast reverse is possible when in the pause mode.

### Pausing during playback

#### Player only:

Press the PLAY/PAUSE key during playback.

- The track number and the amount of time elapsed for the track being played back will blink in the information display area, and playback will be paused.
- Press the PLAY/PAUSE key once again to resume playback.

### Stopping playback

#### Press the STOP key.

- The total number of tracks and the total time will be displayed in the information display area.
- The location that playback was stopped will be memorized automatically when the STOP/OFF key is pressed. Playback will be resumed from the memorized location when the ► key is pressed as long as the disc is not replaced or the power switched off.
- The same operations can be performed by pressing the STOP key on the remote controller.

## Playing back audio CDs (CD-DA)

### Switching off the power

Press the STOP key when playback has been halted.

- The same operations can be performed by pressing the STOP key on the remote controller.

### Auto power-off function

The power will be switched off automatically in order to preserve battery power after three or more minutes have elapsed in the stop mode.

## Setting up with the MODE key

It is possible to amend the sound quality and playback styles, and the display style with the use of the MODE key.

The following mode settings will change alternately as follows whenever the MODE key is pressed.

- ▶ **B.BOOST setting:**  
Boosts the bass tones that tend to be suppressed when music is listened to on the headphones.
  - ▶ **Playback mode setting:**  
Enables repeated playback and random playback.
  - ▶ **Display setting:**  
Enables the number of tracks on the CD and time information to be viewed.
- End the procedure by pressing the MODE key.

### Boosting the bass tones (B.BOOST setting)

- 1 Press the MODE key repeatedly to make the [BB off] or [BB on] displays blink.

Perform the next operation within eight seconds.

- 2 Press the ◀◀◀ or ▶▶▶ key.

The display will switch between the following whenever these keys are pressed.

- ▶ **BB off:** Cancels the bass boost function.
- ▶ **BB on:** Boosts the bass tones.

- The B.BOOST setting is canceled when the top cover is opened.

### Repeat playback and random playback (Playback mode setting)

- 1 Press the MODE key repeatedly until the playback mode is displayed.

The currently set mode will blink once the playback mode has been reached.

- 2 Press the ◀◀◀ or ▶▶▶ keys to select the playback mode.

The display will switch between the following whenever these keys are pressed.

- ▶ **OFF:** Cancels repeat playback and random playback.
- ▶ **ONE:** Repeats a single track.  
Repeats the track being played back or the track selected.
- ▶ **ALL:** Repeats all tracks.  
(Folder repeat (FOLD) when CD-ROMs are being played back.)  
Repeats all tracks. (Repeats all files in the folder.)
- ▶ **RANDOM:** Random playback (can only be selected when playback is stopped).  
Randomly selects tracks for playback. Playback will stop once all tracks have been played back. (Random playback can only be canceled when playback is stopped. The Folder Search and Folder Select functions cannot be used when the random mode is in effect.)

- The preset playback mode will be displayed with an icon.
- The B.BOOST setting is canceled when the top cover is opened.

### Viewing CD information (Display setting)

#### Player only:

- 1 Press the MODE key repeatedly to select the CD information display mode.

The currently set mode will blink once the CD information display mode has been reached.

- 2 Press the ◀◀◀ or ▶▶▶ keys to change the display mode.

The display will switch between the following whenever these keys are pressed.

#### When stopped:

- ▶ Total number of tracks
- ▶ Total amount of time

#### During playback:

- ▶ Track number being played back
- ▶ Amount of time elapsed for the track

## Playing back MP3 and WMA files

It is not possible to play back folders (up to 23) and files (up to 200) that exceed the maximum limitations of the media.

If the copyright is in effect for a WMA file, "PROTECTED FILE" will be displayed for that particular file and the player will move onto the next file.

A certain amount of time is required for the player to confirm the media on which MP3 and WMA files have been recorded before playback will commence.

### Playback

Insert the media, and then confirm that the hold function has been released before continuing with subsequent operations.

- 1 Press the PLAY/PAUSE key.

- The power will be switched on and playback will commence.
- The same operation can be performed by pressing the PLAY/PAUSE button on the remote controller.
- The files will be played back in the sequence in which they were recorded (written).
- The □ mark will be displayed when a folder exists in the next layer.
- The ♪ mark will be displayed when a file exists in the next layer.

- 2 Turn the VOLUME knob to adjust the volume.

### Stopping

Press the STOP button.

- The same operation can be performed by pressing the STOP button on the remote controller.

### Searching for the beginning of files

Press the ◀◀◀ or ▶▶▶ keys.

- The beginning of the required file will be located in accordance with the number of times the keys are pressed. Keep the key pressed down to skip consecutively through the files to be played back.
- If the ◀◀◀ key is pressed once during playback, playback will return to the beginning of the file.
- A certain amount of time may be required when searching for the beginning of files depending on the number of files and the situation of the folder layers.

### Pausing during playback

#### Player only:

Press the PLAY/PAUSE key during playback.

- The mode currently set will blink in the display area, and playback will be paused.
- Press the PLAY/PAUSE key once again to resume playback.

### Fast forward and fast reverse

#### Note:

Fast forwarding and fast reversing is not possible with MP3 and WMA files.

### Conceptual diagram of a media directory

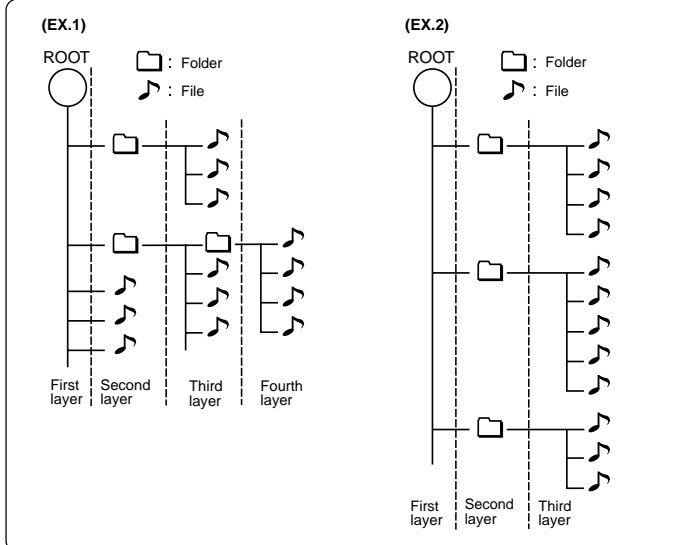

## Playing back MP3 and WMA files

## Using the MODE key for operations

It is possible to search for folders, and amend the sound quality, playback styles and the display style with the use of the MODE key.

The following mode settings will change alternately as follows whenever the MODE key is pressed.

- ▶ **Folder search** (folder search/folder select)
  - ▶ **B.BOOST setting** (boosts the bass tones)
  - ▶ **Playback mode setting**
  - ▶ **Display setting**
- End the procedure by pressing the MODE key.

- The B.BOOST setting and the playback mode setting are the same for audio CDs. Refer to the explanations in the section of CDs.

### Searching for folders (during playback)

Sequentially selects folders.

- 1 Press the MODE key during playback to make the "FOLDER" display blink.

- Perform the next operation within eight seconds.

- 2 Press the ▶▶▶ or ◀◀◀ keys to select the required folder.

▶▶▶ key: Selects the next folder in the sequence it was written.

◀◀◀ key: Selects the previous folder in the sequence it was written.

- The folder name will be displayed inside parenthesis "( )".
- Playback will automatically start from the first file in the folder once a folder has been selected.
- A certain amount of time may be required when searching for folders depending on the number of files and the situation of the folder layers.
- The player will return to the first folder in which files exist when the STOP key is pressed.

### Selecting folders (when stopped)

Selects the folders to be played back directly regardless of the order in which it was written (operated from the player).

- 1 Press the MODE key when stopped to make the "FOLDER" display blink and press the PLAY/PAUSE key to enter the folder selection mode.

- The □ and ♪ marks will blink during folder selection.

- 2 Press the ▶▶▶ or ◀◀◀ keys to select a folder in the same layer.

▶▶▶ key: Selects the next folder in the same layer.

◀◀◀ key: Selects the previous folder in the same layer.

Press the ▶▶ or ◀◀ keys to move to the layer.

▶▶ key: Moves to the lower layer.

◀◀ key: Moves to the higher layer.

- The folder name will be displayed inside parenthesis "( )".
- The □ mark will blink if another folder exists within the selected folder. The ♪ mark will blink if a file exists within the selected folder.
- Press the STOP button to return to ROOT.

- 3 Select the required folder, and then press the PLAY/PAUSE key.

- Playback will start from the first file in the selected folder.
- Files in the next folder will be played back when no files exist in the selected folder.

### Viewing the information contained in the media (Display setting)

This function allows media information, such as the folder and file titles and the number of files contained on the media, to be viewed.

- 1 Press the MODE key to enter the media display mode.
- The currently set mode will blink once the media display mode has been reached.
  - Perform the following operation within eight seconds.

- 2 Press the ◀◀◀ or ▶▶▶ keys to change the display.

The display will switch between the following information whenever these keys are pressed.

#### When stopped:

- ▶ Folder title ( )
- ▶ Total number of files in the folder ( )
- ▶ The total number of files on the media [ ]

#### During playback:

- ▶ The name of the file being played back
- ▶ Title and artist information
- ▶ Folder title ( )
- ▶ Number of the file being played back
- ▶ The amount of time elapsed for the file

## Battery consumption display

The following black-and white inverted mark will be displayed at the liquid crystal display's information display area when the batteries are running low.



The timing for displaying the black-and white inverted marker for indicating the consumption level of the batteries will differ in accordance with the battery type.

Battery type	Timing for displaying the black-and white inverted marker	Action
Rechargeable batteries	When the remaining capacity of the batteries is low	The power will be automatically switched off after a certain period of time. Recharge the batteries.
Alkaline dry-cell batteries	When approximately half of the battery life has been used	Playback is possible while the display is blinking.
When both rechargeable batteries and alkaline dry-cell batteries are used together	When approximately half of the alkaline battery life has been used	Playback is possible while the display is blinking.

Recharge the rechargeable batteries, or replace them with new batteries if alkaline batteries are in use.  
When the batteries run out, the power will be switched off automatically.

## Getting the best out of your player

### Precautions when using rechargeable batteries (NB-150 Nickel-Metal Hydrogen rechargeable batteries)

- Do not use any rechargeable batteries other than the ones specially required by the player. Failure to observe this may result in damage.
- Nickel-Metal Hydrogen rechargeable batteries are used with the player. Owing to the characteristics of these batteries, it is necessary to recharge them at least once every two months even when they have not been used.
- It is possible to recharge the batteries approximately 300 times.
- Replace the rechargeable batteries when the amount of time they can be used is minimal even after recharging (use NB-130 batteries sold separately.)
- A small amount of current will be consumed even when the power to the player is switched off. It is therefore recommended that the batteries are removed if the player will not be used for a long period of time.
- Place the rechargeable batteries in the battery carrying case supplied when carrying them around. There is a risk of the positive and negative poles being shorted if they come into contact with key holders or other metallic objects when carried in a pocket.

The rechargeable batteries have a tendency to become warm when recharged and during use. This is not a defect.

Ensure that the instruction manual supplied with rechargeable batteries is read thoroughly when purchased separately for models that do not include them.

### For rechargeable battery

#### WARNING

- Use specified charger only.
- Do not disassemble or mutilate, may cause burns.
- Do not incinerate or heat, may cause burns, burst or release toxic materials.
- Do not short circuit, may cause burns.
- Keep away from children.

## Problems?

There are cases where problems that appear to indicate a defect are in fact attributable to other causes. In this event, check the problem against the table below to ascertain what the trouble is. (There are cases where requests for service owing to problems attributable to the causes outlined in the table will be charged.)

Symptom	Cause	Recovery
Nothing happens when the operation keys are pressed.	<ul style="list-style-type: none"> <li>The HOLD switch on the player or remote controller is set to HOLD.</li> <li>The batteries have run out.</li> <li>The AC adapter or car battery adapter are not connected.</li> <li>The format of the disc in use is wrong, or it has not been finalized.</li> <li>The wrong procedure has been performed for MODE key operations, or the method of selecting the folder and file is incorrect.</li> </ul>	<ul style="list-style-type: none"> <li>Cancel the HOLD function.</li> <li>Replace both alkaline batteries, or recharge the rechargeable batteries.</li> <li>Connect the adapter properly.</li> <li>Create a disc in a format that can be used. Use only discs that have been correctly finalized.</li> <li>Perform the procedure for playing back MP3 discs and WMA discs correctly.</li> </ul>
No sound is emitted from the headphones.	<ul style="list-style-type: none"> <li>The headphones have not been plugged in far enough.</li> <li>The volume has been turned down on the player or remote controller.</li> </ul>	<ul style="list-style-type: none"> <li>Plug the headphones firmly into the PHONES terminal.</li> <li>Adjust the volume on the player and remote controller.</li> </ul>
The sound skips or breaks up.	<ul style="list-style-type: none"> <li>The D.A.S.C. function (sound skip guard) is switched off.</li> <li>The power of the vibrations exceeds the capabilities of the D.A.S.C. function.</li> <li>The disc is soiled.</li> <li>The lens is soiled.</li> <li>The batteries are running out.</li> </ul>	<ul style="list-style-type: none"> <li>Switch the D.A.S.C. function on.</li> <li>Place the player in a location with minimal vibrations.</li> <li>Clean the disc.</li> <li>Clean the lens.</li> <li>Replace or recharge the batteries.</li> </ul>
White noise can be heard.	<ul style="list-style-type: none"> <li>The headphones plug is soiled.</li> <li>The batteries are running out.</li> <li>The headphones have not been plugged in far enough.</li> </ul>	<ul style="list-style-type: none"> <li>Clean the plug.</li> <li>Replace or recharge the batteries.</li> <li>Plug the headphones firmly into the PHONES terminal.</li> </ul>
The batteries cannot be recharged.	<ul style="list-style-type: none"> <li>Normal dry cell batteries are being used.</li> </ul>	<ul style="list-style-type: none"> <li>Replace the batteries in the player with the rechargeable batteries.</li> </ul>
* "no DISC" is displayed	<ul style="list-style-type: none"> <li>No disc is loaded.</li> <li>The disc has been inserted upside down.</li> </ul>	<ul style="list-style-type: none"> <li>Load a disc that can be played back.</li> <li>Insert the disc with the label facing upwards.</li> </ul>
* "ERROR" is displayed	<ul style="list-style-type: none"> <li>The disc is abnormal. (The disc cannot be read).</li> </ul>	<ul style="list-style-type: none"> <li>Replace with a disc that can be played back.</li> </ul>
* "no FILE" is displayed	<ul style="list-style-type: none"> <li>The disc does not contain the MP3 or WMA files.</li> </ul>	<ul style="list-style-type: none"> <li>Replace with a disc which contains files that can be played back.</li> </ul>

\* The power will be switched off automatically when an error is displayed.

#### Caution:

- This system uses a microcomputer, and there are cases where normal functioning will not be possible owing to noise from external sources and other noise forms. In this event, temporarily unplug the power cord or remove the batteries, and then try again.
- There are cases where malfunctions will occur when the headphones are plugged in and unplugged. This is not a defect.
- There are cases where it is not possible to play back media and files that have not been correctly saved.

### For the U.S.A.

#### CAUTION:

Use of controls or adjustments or performance of procedures other than those specified herein may result in hazardous radiation exposure.

In compliance with Federal Regulations, following are reproductions of labels on, or inside the product relating to laser product safety.

KENWOOD CORPORATION  
2967-3, ISHIKAWA-CHO,  
HACHIOJI-SHI,  
TOKYO, JAPAN

KENWOOD CORP. CERTIFIES THIS EQUIPMENT CONFORMS TO DHHS REGULATIONS NO. 21 CFR 1040.10, CHAPTER 1, SUBCHAPTER J.

Location: Bottom Panel

## Connections

Ensure that the power of all components is off before connecting the cord.

### Using the car battery adapter

- When the unit is not used, unplug the car battery adapter. (Otherwise, the car battery may run out, with some car models.)
- The plug may not match the cigar lighter socket of some car models.
- If the unit cannot be operated with the car battery adapter connected, suspect the possibility of a blown fuse. The fuse can be replaced by turning the electrode on the tip of the adapter plug. When replacing the fuse, be sure to use a fuse with a rating of 1 A.

Car battery adapter (Cars with DC 12V battery only)  
Refer to the "Accessories" table.

Connect to cigar lighter socket

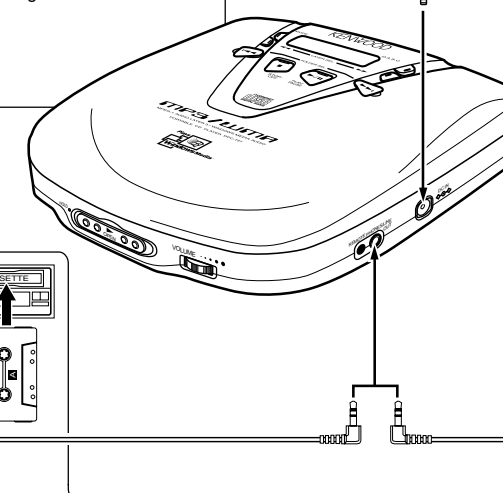

### Listening through car audio

- If sound is not produced, change the tape playing direction of the car stereo. (Sound is not produced if the car stereo is set to play tape side B.)
- Audio reproduction may be impossible with the following type of car stereo. One-way models which have the play head on the left side. Models which function by detecting the tape tension. (With these car stereo models, the car cassette adapter is ejected automatically when it is inserted.)

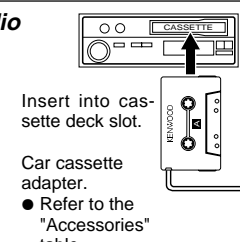

Insert into cassette deck slot.

Car cassette adapter.  
Refer to the "Accessories" table.

Speakers with built-in amplifier

### Before using the car cassette adapter

- This unit can be used exclusively with a KENWOOD portable CD player.
- The direction in which the cord comes out should be changed depending on the car stereo model. Read the following instructions carefully and correct the unit properly before use.

### Usable cassette slot types

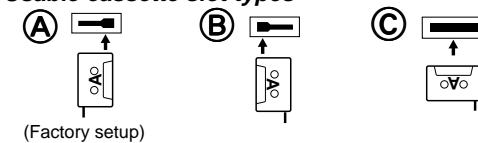

(Factory setup)

## Maintenance

### Simple care

#### Care of lens

When the lens in the pick-up gets dirty, malfunctions including the impossibility of playback may occur. The lens should be cleaned using a commercially available camera lens blower, etc. Do not touch the lens to prevent damaging the mechanism. Also do not use a lens cleaner or disc cleaner product.

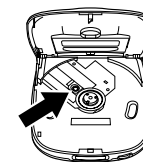

#### Care of main unit

When the unit gets dirty, clean with a soft, dry cloth. If the unit is stained seriously, a moistened cloth can be used. Do not use benzine or thinner for these will damage the unit.

#### Cleaning the plug

Wipe the headphone plug with a soft cloth to keep it clean. A dirty plug may cause noise or malfunction.

### Caution on disc used

#### Usable discs

8 cm single CDs can be played as they are; do not use a commercially-available single CD adapter.

#### Handling

Hold compact discs so that you do not touch the playing surface. Do not attach paper or tape to either the playing side or the label side of compact discs.

#### Never play a cracked or warped disc.

During playback, the disc rotates at high speed in the player. Therefore, to avoid danger, never use a cracked or deformed disc or a disc repaired with tape or adhesive agent.

#### Cleaning

If fingerprints or foreign matter become attached to the disc, lightly wipe the disc with a soft cotton cloth (or similar) from the center of the disc outwards in a radial manner.

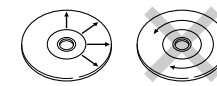

#### Storage

When a disc is not to be played for a long period of time, remove it from the CD player and store it in its case.

### Precaution against condensation

Immediately after a room is heated or in a room with high humidity (or vapor), the unit may malfunction due to the condensation of dew or mist on the pick-up lens. In such a case, leave the unit for about an hour before trying to use it again.

## Caution of hearing (For U.S.A.)



### Dear Customer:

Selecting fine audio equipment such as the unit you've just purchased is only the start of your musical enjoyment. Now it's time to consider how you can maximize the fun and excitement your equipment offers. This manufacturer and the Electronic Industries Association's Consumer Electronics Group want you to get the most out of your equipment by playing it at a safe level. One that lets the sound come through loud and clear without annoying blaring or distortion — and, most importantly, without affecting your sensitive hearing.

Sound can be deceiving. Over time your hearing "comfort level" adapts to higher volumes of sound. So what sounds "normal" can actually be loud and harmful to your hearing. Guard against this by setting your equipment at a safe level BEFORE your hearing adapts.

#### To establish a safe level:

- Start your volume control at a low setting.
- Slowly increase the sound until you can hear it comfortably and clearly, and without distortion.

#### Once you have established a comfortable sound level:

- Set the dial and leave it there.

Taking a minute to do this now will help to prevent hearing damage or loss in the future. After all, we want you listening for a lifetime.

### We Want You Listening For A Lifetime

Used wisely, your new sound equipment will provide a lifetime of fun and enjoyment. Since hearing damage from loud noise is often undetectable until it is too late, this manufacturer and the Electronic Industries Association's Consumer Electronics Group recommend you avoid prolonged exposure to excessive noise. This list of sound levels is included for your protection.

Level	Example
30 dB	Quiet library, soft whispers
40 dB	Living room, refrigerator, bedroom away from traffic
50 dB	Light traffic, normal conversation, quiet office
60 dB	Air conditioner at 20 feet, sewing machine
70 dB	Vacuum cleaner, hair dryer, noisy restaurant
80 dB	Average city traffic, garbage disposals, alarm clock at two feet.

### THE FOLLOWING NOISES CAN BE DANGEROUS UNDER CONSTANT EXPOSURE

90 dB	Subway, motorcycle, truck traffic, lawn mower
100 dB	Garbage truck, chain saw, pneumatic drill
120 dB	Rock band concert in front of speakers, thunderclap
140 dB	Gunshot blast, jet plane
180 dB	Rocket launching pad

Information courtesy of the Deafness Research Foundation.