



FEATURES

- 3.8% EVM @ P_{OUT} = +19 dBm with IEEE 802.11a 64 QAM OFDM at 54 Mbps
- 3% EVM @ P_{OUT} = +20 dBm with IEEE 802.11g 64 QAM OFDM at 54 Mbps
- -40 dBc 1st Sidelobe, -55 dBc 2nd sidelobe ACPR at +23 dBm with IEEE 802.11b CCK/ DSSS Gaussian Filtering at 1 Mbps
- 32 dB of Linear Power Gain at 2.4 GHz
- 35 dB of Linear Power Gain at 5 GHz
- Single +3.3 V Supply
- Dual Temperature-Compensated Linear Power Detectors
- 4 mm x 4 mm x 0.9 mm LPCC Lead-Free RoHS-Compliant Package
- 50 Ω - Matched RF Ports
- >1 kV ESD Rating (HBM)
- MSL 2 Rating

APPLICATIONS

- 802.11a/b/g WLAN

PRODUCT DESCRIPTION

The ANADIGICS AWL9924 dual band power amplifier is a high performance InGaP HBT power amplifier IC designed for transmit applications in the 2.4-2.5 GHz and 4.9-5.9 GHz band. Matched to 50 Ω at all RF inputs and outputs, the part requires no additional RF matching components off-chip, making the AWL9924 the world's simplest dual band PA IC implementation available. The PA exhibits unparalleled linearity and efficiency for IEEE 802.11g, 802.11b and 802.11a WLAN systems under the toughest signal configurations within these standards.

The power detectors are temperature compensated on chip, enabling separate single-ended output voltages for each band with excellent accuracy over a wide range of operating temperatures. The PA is biased by a single +3.3 V supply and consumes ultra-low current in the OFF mode.

The AWL9924 is manufactured using advanced InGaP HBT technology that offers state-of-the-art reliability, temperature stability and ruggedness. The

AWL9924

2.4/5 GHz 802.11a/b/g
WLAN Power Amplifier

PRELIMINARY DATA SHEET - Rev 1.3

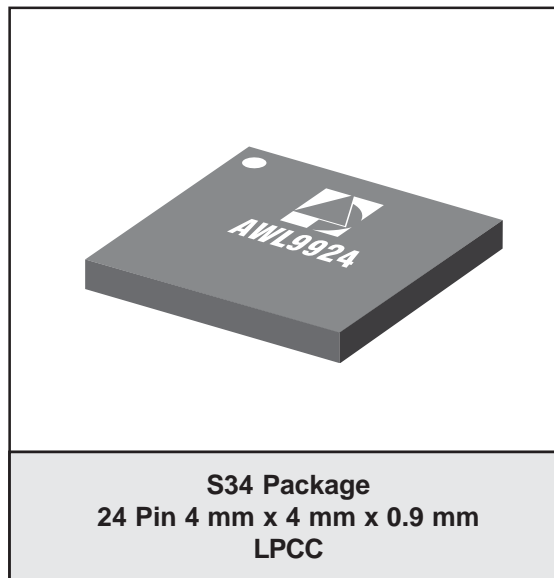

S34 Package
24 Pin 4 mm x 4 mm x 0.9 mm
LPCC

IC is provided in a 4 mm x 4 mm x 0.9 mm LPCC package optimized for a 50 Ω system.

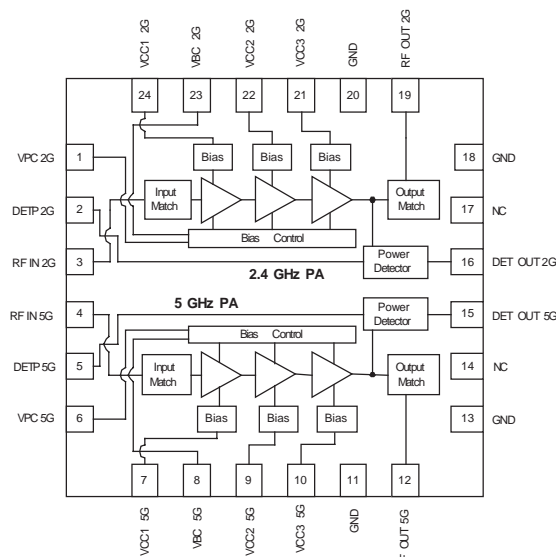

Figure 1: Block Diagram and Pinout

Table 1: Pin Description

PIN	NAME	DESCRIPTION
1	V _{PC} 2G	2 GHz Power Control. The recommended use is for on/off control of the PA. Nominally, 0 V applied will turn amplifier completely off; +3.3 V should be used to set amplifier to maximum output capability. A series resistor is used to set the current flow into the pin, thereby controlling the overall bias level of the pin.
2	DETP 2G	2 GHz Detector Bias. Supply voltage and current is applied to this pin to apply power to the detector circuits inside the PA.
3	RF _{IN} 2G	2 GHz RF Input. AC coupled input stage internally matched to 50 Ω.
4	RF _{IN} 5G	5 GHz RF Input. AC coupled input stage internally matched to 50 Ω.
5	DETP 5G	5 GHz Detector Bias. Supply voltage and current is applied to this pin to apply power to the detector circuits inside the 5 GHz PA.
6	V _{PC} 5G	5 GHz Power Control. The recommended use is for on/off control of the PA. Nominally, 0 V applied will turn amplifier completely off; +3.3 V should be used to set amplifier to maximum output capability. A series resistor is used to set the current flow into the pin, thereby controlling the overall bias level of the pin.
7	V _{CC1} 5G	5 GHz Supply Voltage. Bias for power transistor of stage 1 of the 5 GHz PA.
8	V _{BC} 5G	5 GHz Bias Circuit Voltage. Supply voltage and current is applied to this pin to apply power to the bias circuits inside the 5 GHz PA.
9	V _{CC2} 5G	5 GHz Supply Voltage. Bias for power transistor of stage 2 of the 5 GHz PA.
10	V _{CC3} 5G	5 GHz Supply Voltage. Bias for power transistor of stage 3 of the 5 GHz PA.
11	GND	Ground
12	RF _{OUT} 5G	5 GHz RF Output. AC coupled output stage internally matched to 50 Ω. Route as coplanar waveguide using adjacent ground pins. Although the output stage is AC coupled, a shunt inductive matching element included inside the PA after the AC coupling capacitor provides a DC path to ground at this pin.
13	GND	Ground
14	NC	No Connection
15	DETOU 5G	5 GHz Power Detector Output (DC coupled). An emitter follower BJT supplies the output for this pin.
16	DETOU 2G	2 GHz Power Detector Output (DC coupled). An emitter follower BJT supplies the output for this pin.
17	NC	No Connection
18	GND	Ground
19	RF _{OUT} 2G	2 GHz RF Output. AC coupled output stage internally matched to 50 Ω. Route as coplanar waveguide using adjacent ground pins. Although the output stage is AC coupled, a shunt inductive matching element included inside the PA after the AC coupling capacitor provides a DC path to ground at this pin.

Table 1: Pin Description (Continued)

PIN	NAME	DESCRIPTION
20	GND	Ground
21	V _{CC3} 2G	2 GHz Supply Voltage. Bias for power transistor of stage 3 of the 2 GHz PA.
22	V _{CC2} 2G	2 GHz Supply Voltage. Bias for power transistor of stage 2 of the 2 GHz PA.
23	V _{BC} 2G	2 GHz Bias Circuit Voltage. Supply voltage and current is applied to this pin to apply power to the bias circuits inside the 2 GHz PA.
24	V _{CC1} 2G	2 GHz Supply Voltage. Bias for power transistor of stage 1 of the 2 GHz PA.

ELECTRICAL CHARACTERISTICS

Table 2: Absolute Minimum and Maximum Ratings

PARAMETER	MIN	MAX	UNIT	COMMENTS
DC Power Supply (V_{CC1} 2G, V_{CC2} 2G, V_{CC3} 2G, V_{CC1} 5G, V_{CC2} 5G, V_{CC3} 5G)	-	+4.5	V	
Power Control Level (V_{PC} 2G, V_{PC} 5G)	-	+4.5	V	Applied to series resistors external to V_{PC} 2G and V_{PC} 5G pins. No RF signal applied.
Bias Control (V_{BC} 2G, V_{BC} 5G)	-	+4.5	V	Applied to series resistors external to V_{BC} 2G and V_{BC} 5G pins. No RF signal applied.
DC Current Consumption	-	700	mA	Either PA powered separately
RF Input Level (RF_{IN} 2G, RF_{IN} 5G)	-	-5	dBm	
Operating Ambient Temperature	-40	+85	°C	
Storage Temperature	-55	+150	°C	

Stresses in excess of the absolute ratings may cause permanent damage. Functional operation is not implied under these conditions. Exposure to absolute ratings for extended periods of time may adversely affect reliability.

Table 3: Operating Ranges

PARAMETER	MIN	TYP	MAX	UNIT	COMMENTS
Operating Frequency (f)	2400 4900	- -	2500 5900	MHz	802.11b/g 802.11a
Supply Voltage (V_{CC1} 2G, V_{CC2} 2G, V_{CC3} 2G, V_{CC1} 5G, V_{CC2} 5G, V_{CC3} 5G)	+3.0	+3.3	+3.6	V	
Bias Voltage (V_{BC} 2G, V_{BC} 5G)	+3.0	+3.3	+3.6	V	Applied to series resistors external to V_{BC} 2G and V_{BC} 5G pins.
Power Control Voltage (V_{PC} 2G, V_{PC} 5G)	- 0	+3.3 -	- +0.5	V	PA "ON" ⁽¹⁾ PA "SHUTDOWN" ⁽¹⁾
Case Temperature (T_C)	-40	-	+85	°C	

The device may be operated safely over these conditions; however, parametric performance is guaranteed only over the conditions defined in the electrical specifications.

Note:

(1) Applied to series resistors external to V_{PC} 2G and V_{PC} 5G pins.

Table 4: Electrical Specifications - 2.4 GHz Continuous Wave
(T_c = +25 °C, V_{CC 2G} = +3.3 V, V_{PC 2G} = +3.3 V)

PARAMETER	MIN	TYP	MAX	UNIT	COMMENTS
P1dB	26.5	27.5	28.5	dB	
Shutdown Current	-	-	5	μA	V _{PC 2G} = 0 V
Quiescent Current	60	70	80	mA	V _{PC 2G} = +3.3 V, V _{CC 2G} = +3.3 V RF = off
Input Return Loss	-	-11	-9	dB	
Output Return Loss	-	-13	-11	dB	
Reverse Isolation	40	-	-	dB	
Stability (Spurious)	-	-70	-65	dBc	6:1 VSWR, at P _{OUT} = +23 dBm, -5 °C
T _{ON} Setting Time	-	-	1	μS	Settles within ±0.5 dB
T _{OFF} Setting Time	-	-	1	μS	

Table 5: Electrical Specifications - 5 GHz Continuous Wave
(T_c = +25 °C, V_{CC 5G} = +3.3 V, V_{PC 5G} = +3.3 V)

PARAMETER	MIN	TYP	MAX	UNIT	COMMENTS
P1dB	25.0	26.0	27.0	dB	
Shutdown Current	-	-	5	μA	V _{PC 5G} = 0 V
Quiescent Current	100	120	145	mA	V _{PC 5G} = +3.3 V, V _{CC 5G} = +3.3 V RF = off
Input Return Loss	-	-12	-7	dB	
Output Return Loss	-	-14	-12	dB	
Reverse Isolation	40	-	-	dB	
Stability (Spurious)	-	-65	-60	dBc	6:1 VSWR, at P _{OUT} = +22 dBm; -5 °C
T _{ON} Setting Time	-	-	1	μS	Settles within ±0.5 dB
T _{OFF} Setting Time	-	-	1	μS	

AWL9924

Table 6: Electrical Specifications - IEEE 802.11g
 (T_c = +25 °C, V_{CC} 2G = +3.3 V, V_{PC} 2G = +3.3 V, 64 QAM OFDM 54 Mbps)

PARAMETER	MIN	TYP	MAX	UNIT	COMMENTS
Operating Frequency	2400	-	2500	MHz	
Power Gain	30	32	34	dB	
Gain Ripple	-	± 0.5	-	dB	Across 100 MHz band
Error Vector Magnitude (EVM) ⁽¹⁾	- -	3.0 -30.5	3.8 -28.4	% dB	802.11g 54 Mbps data rate P _{OUT} 2G = +20 dBm
Current Consumption	170	190	205	mA	P _{OUT} 2G = +20 dBm
Harmonics 2fo 3fo	- -	-40 -35	-35 -30	dBc	P _{OUT} 2G = +20 dBm
Power Detector Voltage	0.74	0.85	0.90	V	P _{OUT} 2G = +20 dBm
Power Detector Sensitivity	60	65	70	mV/dB	10 dBm < P _{OUT} < 21 dBm
Power Detector Output Load Impedance	2	-	-	kΩ	

Note:

(1) EVM includes system noise floor of 1% (-40 dB).

Table 7: Electrical Specifications - IEEE 802.11b
(T_C = +25 °C, V_{CC 2G} = +3.3 V, V_{PC 2G} = +3.3 V, CCK/DSSS, 1 Mbps, Gaussian Baseband Filtering)

PARAMETER	MIN	TYP	MAX	UNIT	COMMENTS
Operating Frequency	2400	-	2500	MHz	
Power Gain	30.0	32.0	33.5	dB	
Gain Ripple	-	± 0.5	-	dB	Across 100 MHz band
Adjacent Channel Power (ACPR) 1st Sidelobe (± 11 MHz Offset)	-	-40	-35	dBc	1 Mbps Gaussian Baseband Filtering; P _{OUT 2G} = +20 dBm
Adjacent Channel Power (ACPR) 2nd Sidelobe (± 22 MHz Offset)	-	-60	-55	dBc	1 Mbps Gaussian Baseband Filtering; P _{OUT 2G} = +20 dBm
Current Consumption	- - -	170 210 250	180 220 265	mA	P _{OUT 2G} = +19 dBm P _{OUT 2G} = +21 dBm P _{OUT 2G} = +23 dBm
Harmonics 2fo 3fo	- -	-35 -35	-30 -30	dBc	P _{OUT 2G} = +23 dBm
Power Detector Voltage	1.00	1.10	1.15	V	P _{OUT 2G} = +23 dBm
Power Detector Sensitivity	70	80	90	mV/dB	10 dBm < P _{OUT} < 23 dBm
Power Detector Output Load Impedance	2	-	-	kΩ	

AWL9924

Table 8: Electrical Specifications - IEEE 802.11a
(T_c = +25 °C, V_{CC} 5G = +3.3 V, V_{PC} 5G = +3.3 V, 64 QAM OFDM 54 Mbps)

PARAMETER	MIN	TYP	MAX	UNIT	COMMENTS
Operating Frequency	4900	-	5900	MHz	
Power Gain	33 27	35 32	37 34	dB	4.9 - 5.35 GHz 5.5 - 5.85 GHz
Gain Ripple	-	±0.5	-	dB	Across 100 MHz band
Error Vector Magnitude (EVM) ⁽¹⁾	- - - -	3.8 -28 4.4 -27	4.4 -27 5.0 -26	% dB % dB	P _{OUT} 5G = +19 dBm, 4.9 - 5.35 GHz 802.11a 54 Mbps data rate P _{OUT} 5G = +18.5 dBm, 5.5 - 5.85 GHz 802.11a 54 Mbps data rate
Current Consumption	165	190	220	mA	P _{OUT} 5G = +19 dBm
Harmonics 2fo 3fo	- -	-35 -40	-30 -35	dBc	P _{OUT} 5G = +20 dBm
Power Detector Voltage	0.90	1.00	1.10	V	P _{OUT} 5G = +19 dBm
Power Detector Sensitivity	65	80	95	mV/dB	10 dBm < P _{OUT} < 21 dBm
Power Detector Output Load Impedance	2	-	-	kΩ	

Notes:

(1) EVM includes system noise floor of 1% (-40dB).

802.11g PERFORMANCE DATA

Figure 2: Gain vs. Output Power Across Frequency ($V_{CC} = +3.3\text{ V}$, $T_C = +25^\circ\text{C}$)
2.4 GHz 802.11g 54 Mbps OFDM

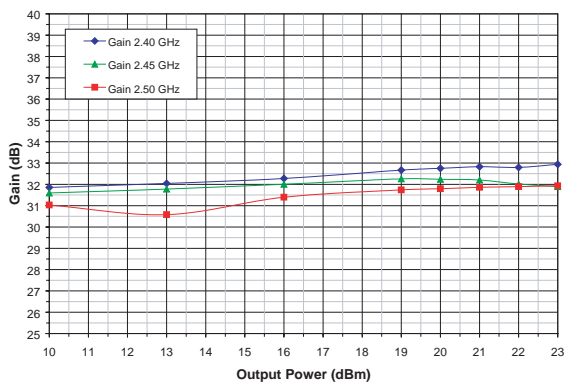
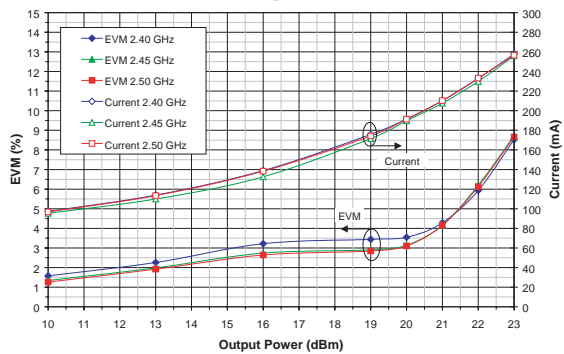

Figure 3: I_{CC} and EVM vs. Output Power Across Frequency ($V_{CC} = +3.3\text{ V}$, $T_C = 25^\circ\text{C}$)
2.4 GHz 802.11g 54 Mbps OFDM



Note: Results at 2.50 GHz obscure the results at 2.40 GHz on the graph.

Figure 4: Gain vs. Output Power Across Temp. (Frequency = 2.45 GHz, $V_{CC} = +3.3\text{ V}$)
2.4 GHz 802.11g 54 Mbps OFDM

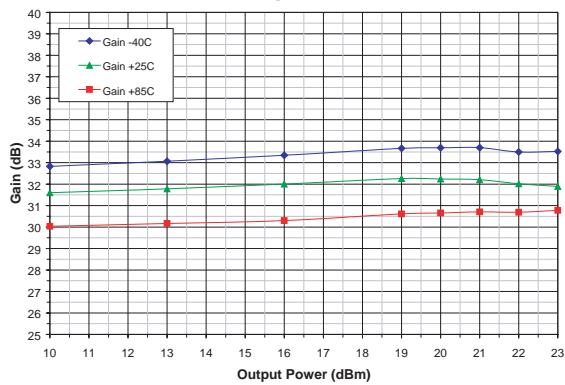

Figure 5: I_{CC} and EVM vs. Output Power Across Temp. (Frequency = 2.45 GHz, $V_{CC} = +3.3\text{ V}$)
2.4 GHz 802.11g 54 Mbps OFDM

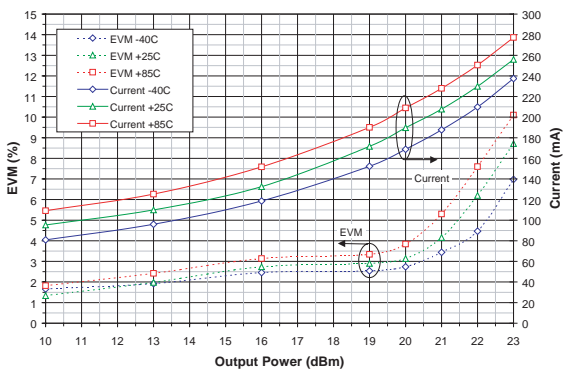

Figure 6: Gain vs. Output Power Across Power Supply Voltage (Frequency = 2.45 GHz, $T_C = 25^\circ\text{C}$)
2.4 GHz 802.11g 54 Mbps OFDM

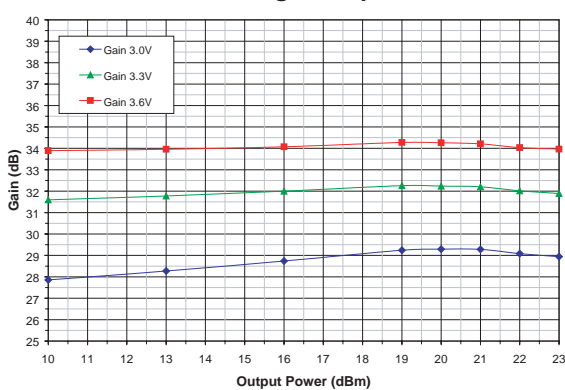
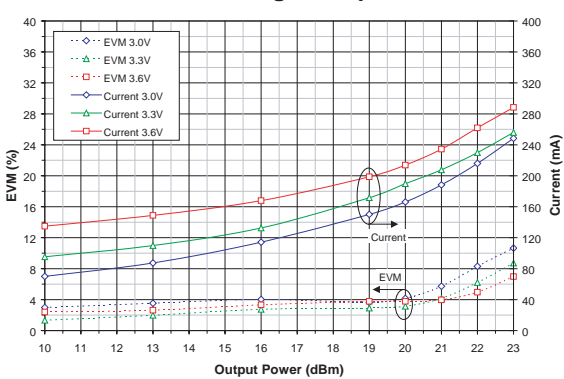

Figure 7: I_{CC} and EVM vs. Output Power Across Power Supply Voltage (Freq = 2.45 GHz, $T_C = 25^\circ\text{C}$)
2.4 GHz 802.11g 54 Mbps OFDM



AWL9924

Figure 8: Detector Voltage vs. Output Power Across Freq. ($V_{CC} = +3.3\text{ V}$, $T_c = 25^\circ\text{C}$, $2\text{ K}\Omega$ Load) 2.4 GHz 802.11g 54 Mbps OFDM

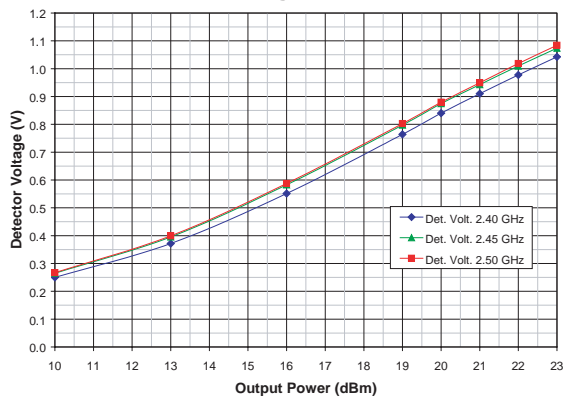

Figure 9: Detector Voltage vs. Output Power Across Temp. (Freq = 2.45 GHz, $V_{CC} = +3.3\text{ V}$, $2\text{ K}\Omega$ Load) 2.4 GHz 802.11g 54 Mbps OFDM

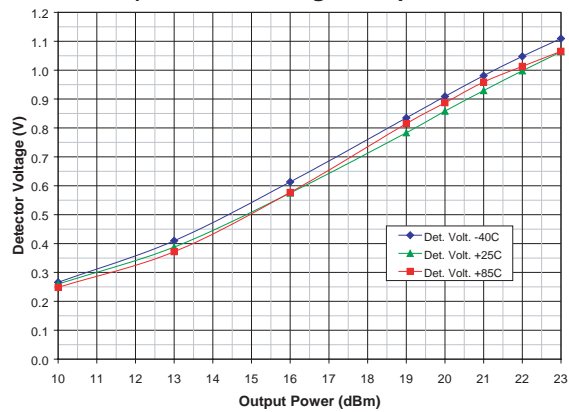
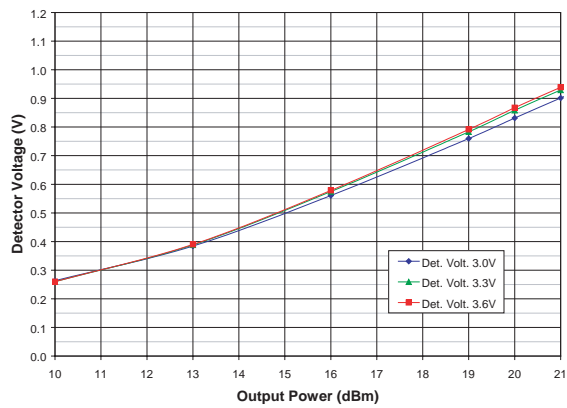

Figure 10: Detector Voltage vs. Output Power Across Supply Voltage (Freq = 2.45 GHz, $T_c = 25^\circ\text{C}$, $2\text{ K}\Omega$ Load) 2.4 GHz 802.11g 54 Mbps OFDM



802.11b PERFORMANCE DATA

Figure 11: Gain and I_{cc} vs. Output Power Across Freq. (V_{cc} = +3.3 V, T_c = 25°C)
2.4 GHz 802.11b Gaussian Filtering
(BT = 0.45), 1 Mbps

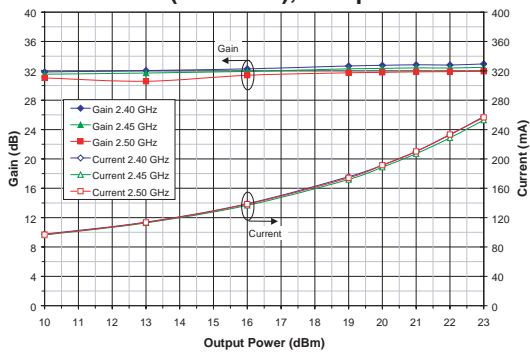

Figure 12: Gain and I_{cc} vs. Output Power Across Temp. (Freq = 2.45 GHz, V_{cc} = +3.3 V)
2.4 GHz 802.11b Gaussian Filtering
(BT = 0.45), 1 Mbps

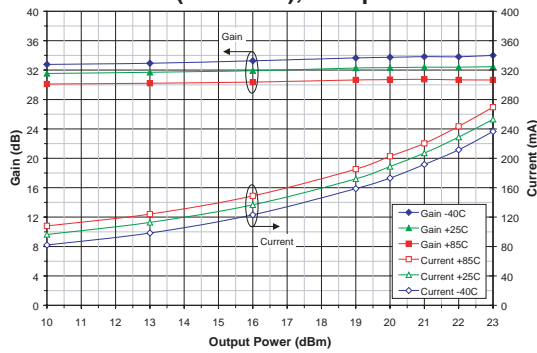

Figure 13: Gain and I_{cc} vs. Output Power Across Supply Voltage (Freq = 2.45 GHz, T_c = 25°C)
2.4 GHz 802.11b Gaussian Filtering
(BT = 0.45), 1 Mbps

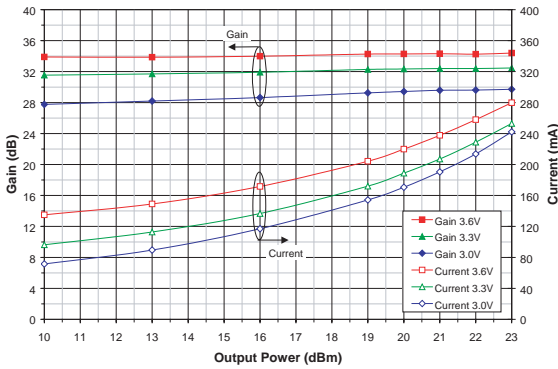

Figure 14: ACPR 1st and 2nd Sidelobes vs. Output Power Across Freq. (V_{cc} = +3.3 V, T_c = 25°C)
2.4 GHz 802.11b Gaussian Filtering
(BT = 0.45), 1 Mbps

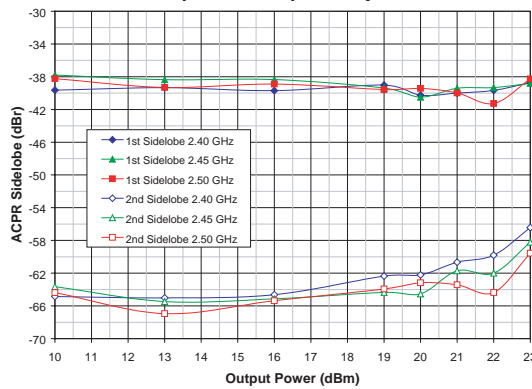

Figure 15: ACPR 1st and 2nd Sidelobes vs. Output Power Across Temp. (Freq = 2.45 GHz, V_{cc} = +3.3 V)
2.4 GHz 802.11b Gaussian Filtering
(BT = 0.45), 1 Mbps

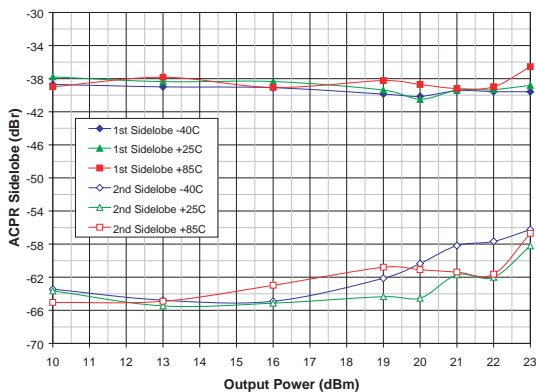
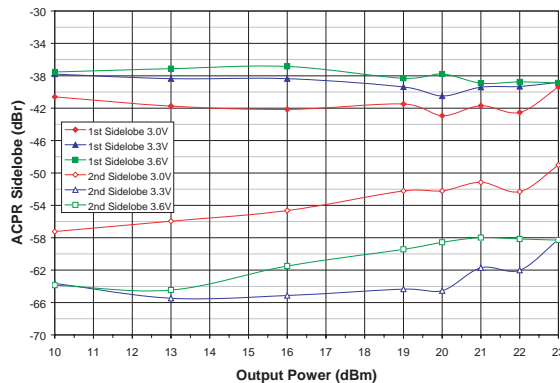
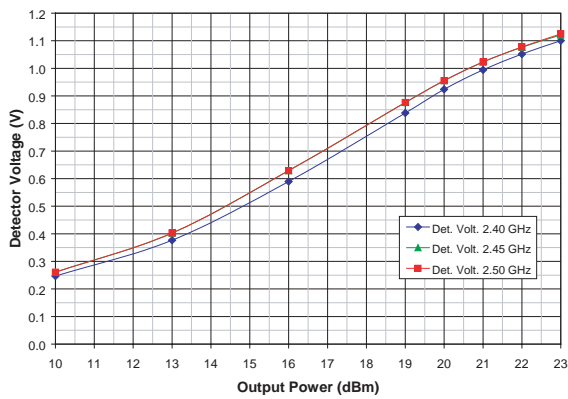

Figure 16: ACPR 1st and 2nd Sidelobes vs. Output Power Across Supply Voltage (Freq = 2.45 GHz, T_c = 25°C)
2.4 GHz 802.11b Gaussian Filtering
(BT = 0.45), 1 Mbps



AWL9924

Figure 17: Detector Voltage vs. Output Power Across Freq ($V_{CC} = +3.3\text{ V}$, $T_c = 25^\circ\text{C}$, $2\text{ K}\Omega$ Load) 2.4 GHz 802.11b Gaussian Filtering (BT = 0.45), 1 Mbps



Note: Results at 2.50 GHz obscure the results at 2.45 GHz on the graph.

Figure 18: Detector Voltage vs. Output Power Across Temp (Freq = 2.45 GHz, $V_{CC} = +3.3\text{ V}$, $2\text{ K}\Omega$ Load) 2.4 GHz 802.11b Gaussian Filtering (BT = 0.45), 1 Mbps

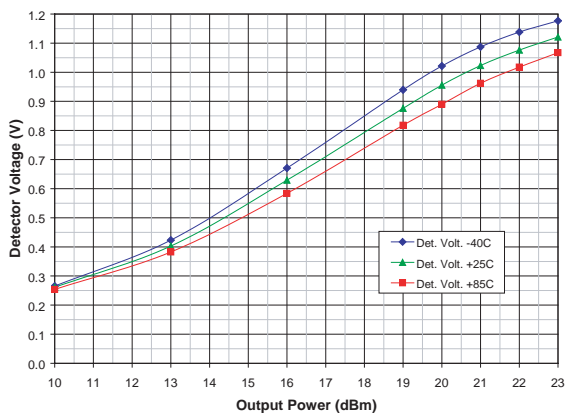
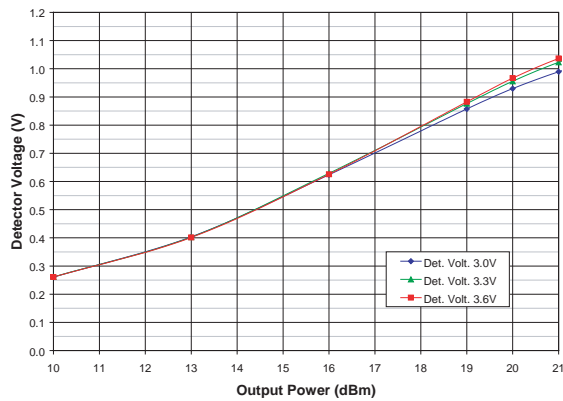

Figure 19: Detector Voltage vs. Output Power Across Supply Voltage (Freq = 2.45 GHz, $T_c = 25^\circ\text{C}$, $2\text{ K}\Omega$ Load) 2.4 GHz 802.11b Gaussian Filtering (BT = 0.45), 1 Mbps



802.11a PERFORMANCE DATA

Figure 20: Gain vs. Output Power Across Freq
($V_{CC} = +3.3\text{ V}$, $T_c = 25^\circ\text{C}$)
5 GHz 802.11a 54 Mbps OFDM

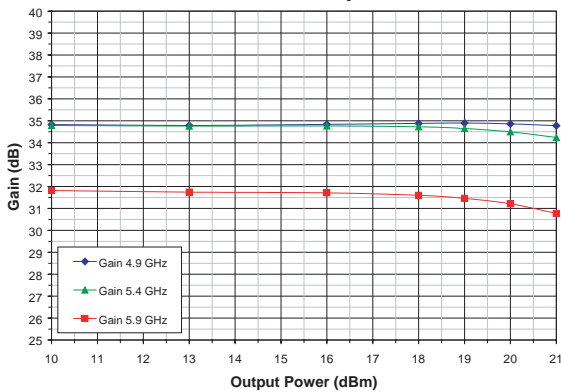

Figure 21: I_{CC} and EVM vs. Output Power Across Freq
($V_{CC} = +3.3\text{ V}$, $T_c = 25^\circ\text{C}$)
5 GHz 802.11a 54 Mbps OFDM

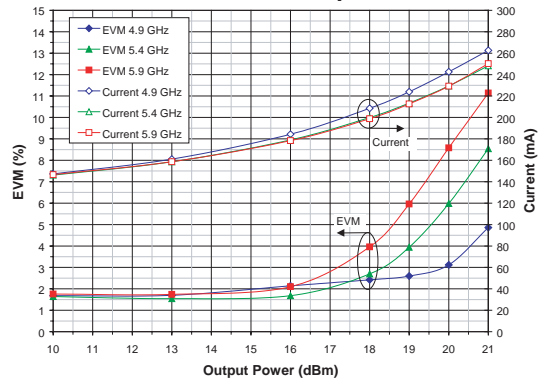

Figure 22: Gain vs. Output Power Across Temp
(Freq = 5.40 GHz, $V_{CC} = +3.3\text{ V}$)
5 GHz 802.11a 54 Mbps OFDM

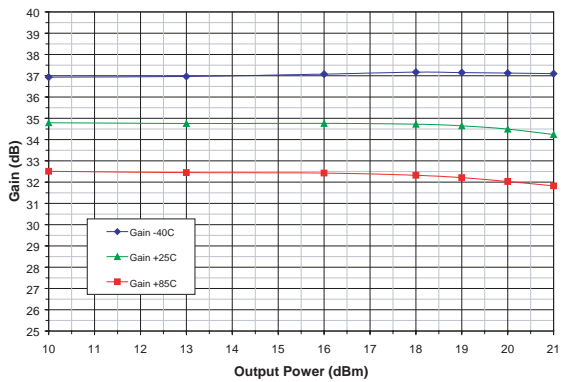

Figure 23: I_{CC} and EVM vs. Output Power Across Temp
(Freq = 5.4 GHz, $V_{CC} = +3.3\text{ V}$)
5 GHz 802.11a 54 Mbps OFDM

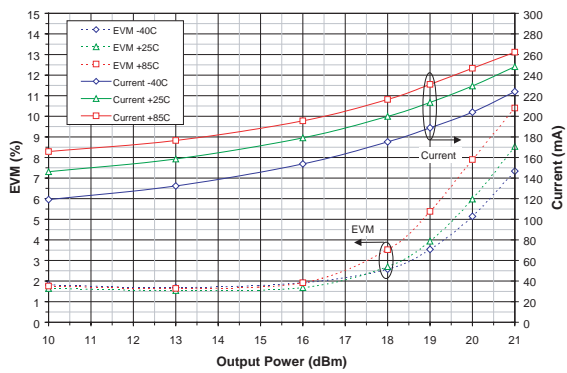

Figure 24: Gain vs. Output Power Across Supply Voltage
(Freq = 5.40 GHz, $T_c = 25^\circ\text{C}$)
5 GHz 802.11a 54 Mbps OFDM

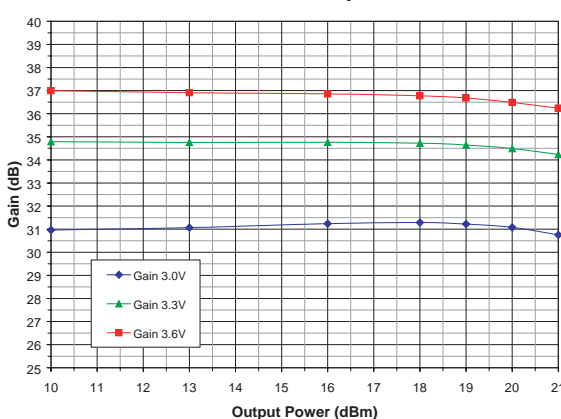
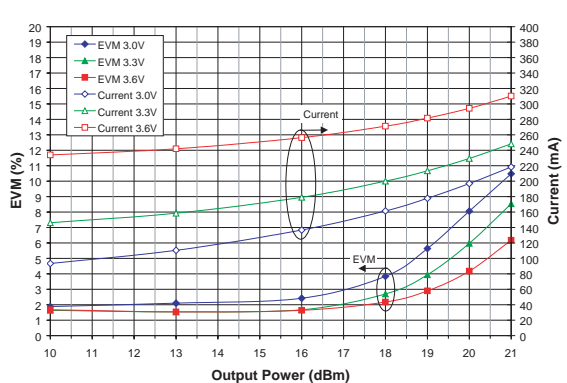
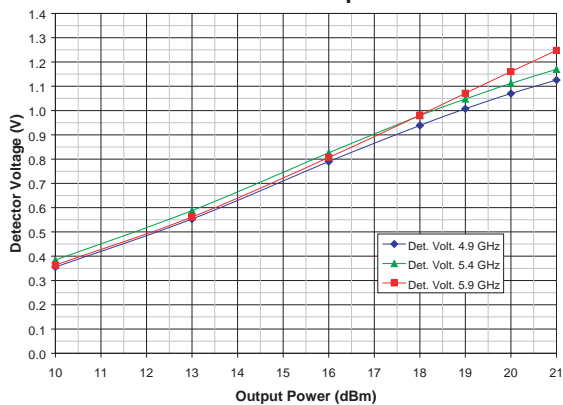

Figure 25: I_{CC} and EVM vs. Output Power Across Supply Voltage
(Freq = 5.40 GHz, $T_c = 25^\circ\text{C}$)
5 GHz 802.11a 54 Mbps OFDM



AWL9924

**Figure 26: Detector Voltage vs. Output Power Across Freq ($V_{CC} = +3.3\text{ V}$, $T_c = 25^\circ\text{C}$, $2\text{ K}\Omega$ Load)
5 GHz 802.11a 54 Mbps OFDM**



**Figure 27: Detector Voltage vs. Output Power Across Temp (Freq = 5.40 GHz, $V_{CC} = +3.3\text{ V}$, $2\text{ K}\Omega$ Load)
5 GHz 802.11a 54 Mbps OFDM**

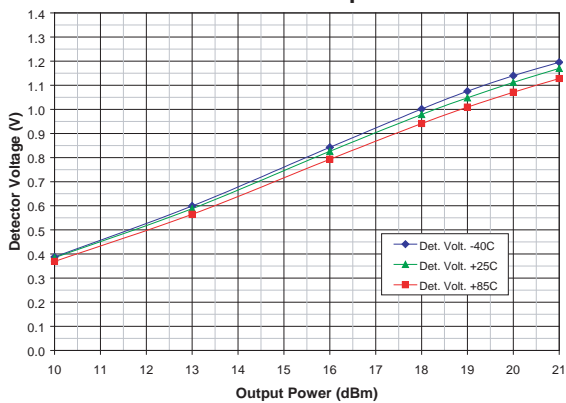

**Figure 28: Detector Voltage vs. Output Power Across Supply Voltage (Freq = 5.40 GHz, $T_c = 25^\circ\text{C}$)
5 GHz 802.11a 54 Mbps OFDM**

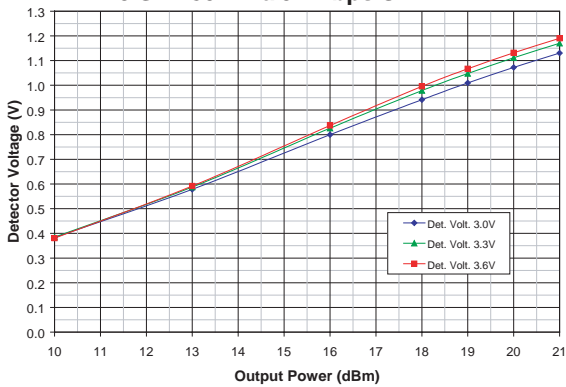

2.4 AND 5 GHz S-PARAMETERS

Figure 29: 2 GHz Input and Output Return Losses vs. Freq ($V_{cc} = +3.3$ V, $T_c = 25^\circ\text{C}$)

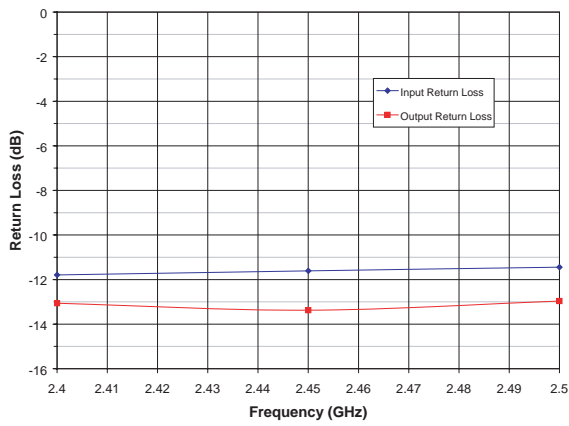

Figure 30: 2 GHz Input Return Loss vs. Frequency Across Temperature ($V_{cc} = +3.3$ V)

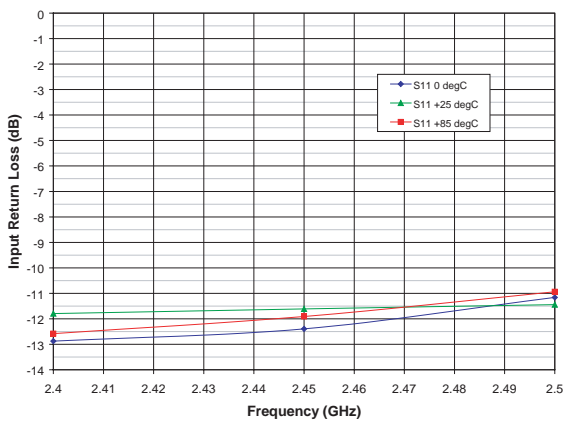

Figure 31: 2 GHz Output Return Loss vs. Frequency Across Temperature ($V_{cc} = +3.3$ V)

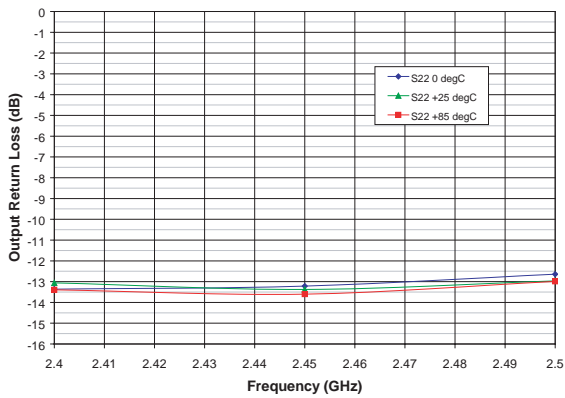

Figure 32: 5 GHz Input and Output Return Losses vs. Freq ($V_{cc} = +3.3$ V, $T_c = 25^\circ\text{C}$)

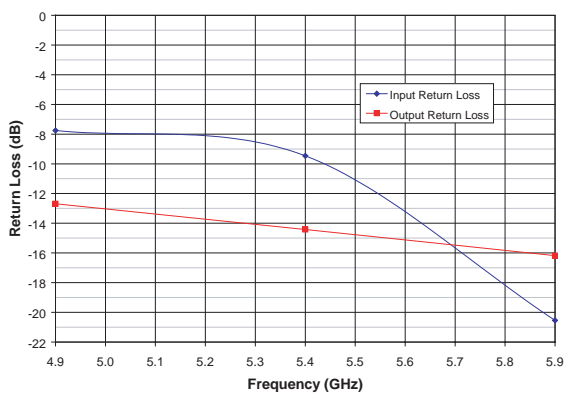

Figure 33: 5 GHz Input Return Loss vs. Frequency Across Temperature ($V_{cc} = +3.3$ V)

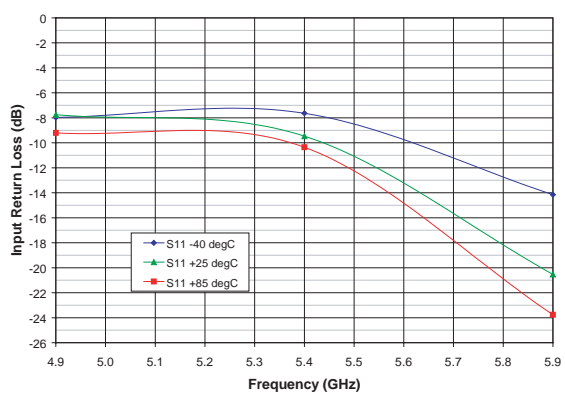
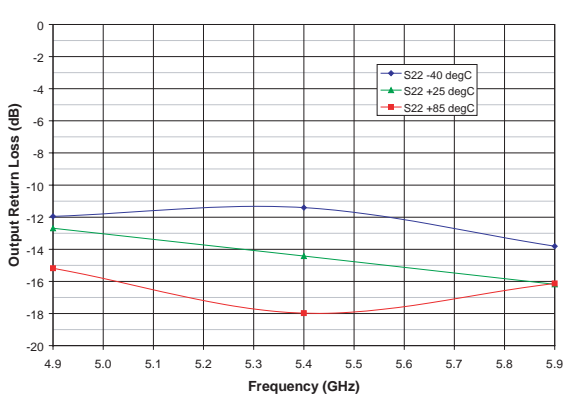

Figure 34: 5 GHz Output Return Loss vs. Frequency Across Temperature ($V_{cc} = +3.3$ V)



AWL9924

APPLICATION INFORMATION

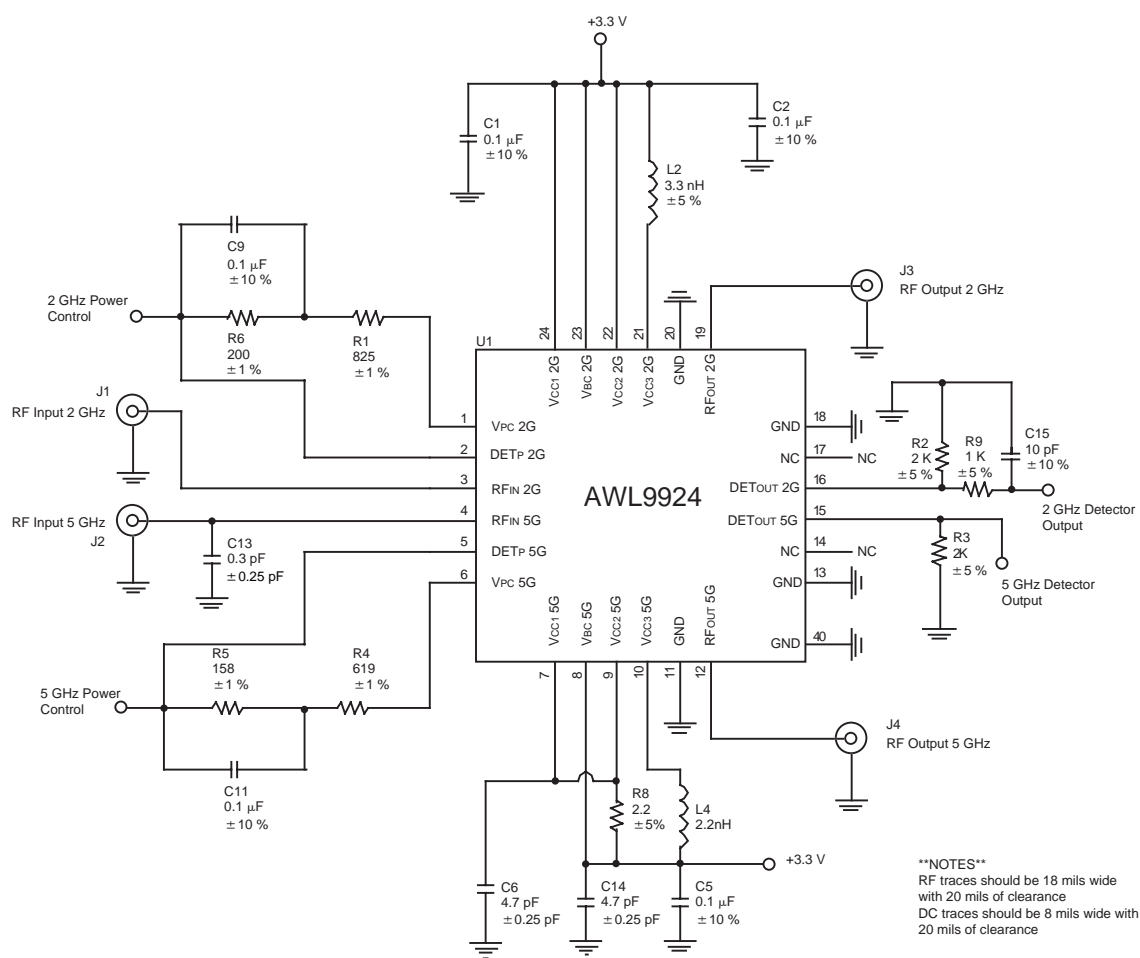
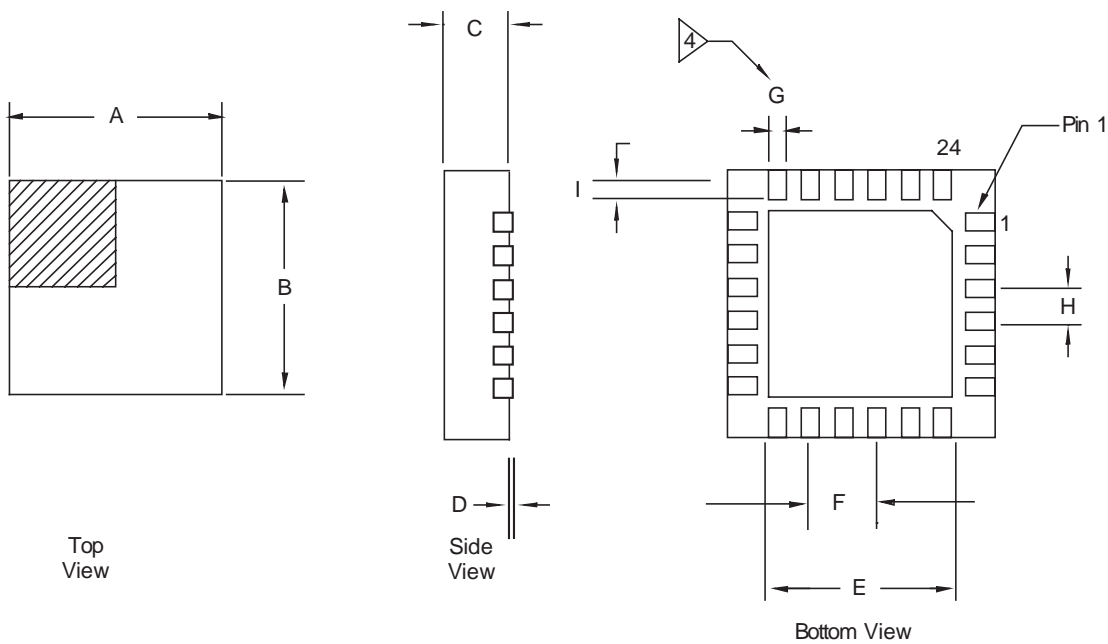

Figure 35: Application Circuit

PACKAGE OUTLINE



DIMENSION	MILLIMETERS		
	MIN	TYP	MAX
A	3.90	4.00	4.10
B	3.90	4.00	4.10
C	0.80	0.90	1.00
D	0.00	0.02	0.05
E	2.50	2.65	2.80
F	1.00 BSC.		
G	0.180	0.250	0.300
H	0.50 BSC.		
I	0.35	0.40	0.45

1. All dimensions are in millimeters, angles in degrees.
2. The terminal #1 identifier and pad numbering convention shall conform to JESD 95-1 SPP-012
3. Lead coplanarity: 0.05 max.
4. Dimension applies to metalized pad and is measured between 0.25 and 0.30 MM from pad tip.

Figure 36: S34 Package Outline - 24 Pin 4 mm x 4 mm x 0.9 mm LPCC

AWL9924

NOTES

AWL9924

NOTES

AWL9924

ORDERING INFORMATION

ORDER NUMBER	TEMPERATURE RANGE	PACKAGE DESCRIPTION	COMPONENT PACKAGING
AWL9924RS34Q1	-40 °C to +85°C	24 Pin 4 mm x 4 mm x 0.9 mm LPCC	1,000 piece Tape and Reel
AWL9924RS34P0	-40 °C to +85°C	24 Pin 4 mm x 4 mm x 0.9 mm LPCC	1-999 piece Tubes
AWL9924RS34P6	-40 °C to +85°C	24 Pin 4 mm x 4 mm x 0.9 mm LPCC	1-999 piece Tray
EVA9924RS34	-40 °C to +85°C	24 Pin 4 mm x 4 mm x 0.9 mm LPCC	1 piece Evaluation Board



ANADIGICS, Inc.

141 Mount Bethel Road
Warren, New Jersey 07059, U.S.A.
Tel: +1 (908) 668-5000
Fax: +1 (908) 668-5132

URL: <http://www.anadigics.com>
E-mail: Mktg@anadigics.com

IMPORTANT NOTICE

ANADIGICS, Inc. reserves the right to make changes to its products or to discontinue any product at any time without notice. The product specifications contained in Advanced Product Information sheets and Preliminary Data Sheets are subject to change prior to a product's formal introduction. Information in Data Sheets have been carefully checked and are assumed to be reliable; however, ANADIGICS assumes no responsibilities for inaccuracies. ANADIGICS strongly urges customers to verify that the information they are using is current before placing orders.

WARNING

ANADIGICS products are not intended for use in life support appliances, devices or systems. Use of an ANADIGICS product in any such application without written consent is prohibited.