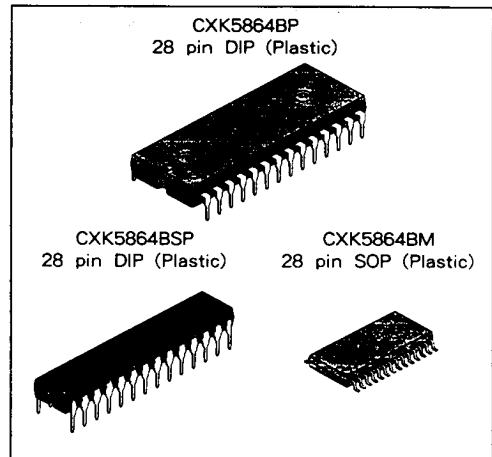

SONY**CXK5864BP/BSP/BM** -70L/10L/12L/
-70LL/10LL/12LL**8,192-word × 8-bit High Speed CMOS Static RAM** *Maintenance Only***Description**

CXK5864BP/BSP/BM are 65,536 bits high speed CMOS static RAMs organized as 8,192 words by 8 bits and operates from a single 5V supply. These IC are suitable for use in high speed and low power applications in which battery back up for nonvolatility is required.

Features

- Fast access time (Access time)
CXK5864BP/BSP/BM-70L, 70LL 70ns(Max.)
CXK5864BP/BSP/BM-10L, 10LL 100ns(Max.)
CXK5864BP/BSP/BM-12L, 12LL 120ns(Max.)
- Low power operation :
CXK5864BP/BSP/BM-70LL, 10LL, 12LL ;
Standby/Operation : 5 μ W (Typ.) /40mW (Typ.)
CXK5864BP/BSP/BM-70L, 10L, 12L ;
Standby/Operation : 10 μ W (Typ.) /40mW (Typ.)
- Single power supply 5V : +5V \pm 10%
- Fully static memory ... No clock or timing strobe required
- Equal access and cycle time
- Common data input and output : three state output
- Directly TTL compatible : All inputs and outputs
- Low voltage data retention : 2.0V (Min.)
- Available in 28 pin 600mil DIP, 300mil DIP and 450mil SOP

**Function**

8,192-word × 8-bit static RAM

Structure

Silicon gate CMOS IC

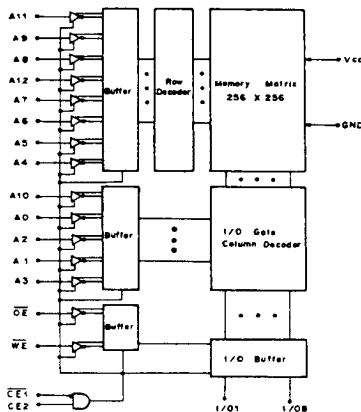
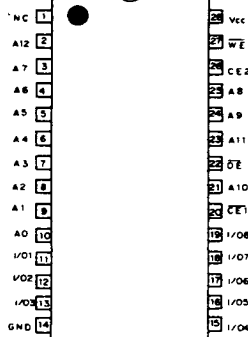
Block Diagram**Pin Configuration**
(Top View)**Pin Description**

Symbol	Description
A0 to A12	Address input
I/O1 to I/O8	Data input output
CE1, CE2	Chip enable 1, 2 input
WE	Write enable input
OE	Output enable input
Vcc	+5V Power supply
GND	Ground
NC	No connection

E89720B0Y - ST

Absolute Maximum Ratings

(Ta = 25°C, GND = 0V)

Item	Symbol	Rating	Unit
Supply voltage	V _{CC}	- 0.5 to + 7.0	V
Input voltage	V _{IN}	- 0.5* to V _{CC} + 0.5	V
Input and output voltage	V _{I/O}	- 0.5* to V _{CC} + 0.5	V
Allowable power dissipation	P _D	CXK5864BP/BSP	1.0
		CXK5864BM	0.7
Operating temperature	T _{opr}	0 to + 70	°C
Storage temperature	T _{stg}	- 55 to + 150	°C
Soldering temperature • time	T _{solder}	260 • 10	°C • sec

* V_{IN}, V_{I/O} = - 3.0V Min. for pulse width less than 50ns.

Truth Table

CE1	CE2	OE	WE	Mode	I/O1 to I/O8	V _{CC} Current
H	X	X	X	Not selected	High Z	I _{SB1} , I _{SB2}
X	L	X	X	Not selected	High Z	I _{SB1} , I _{SB2}
L	H	H	H	Output disable	High Z	I _{CC1} , I _{CC2}
L	H	L	H	Read	Data out	I _{CC1} , I _{CC2}
L	H	X	L	Write	Data in	I _{CC1} , I _{CC2}

X: "H" or "L"

DC Recommended Operating Conditions (Ta = 0 to + 70°C, GND = 0V)

Item	Symbol	Min.	Typ.	Max.	Unit
Supply voltage	V _{CC}	4.5	5.0	5.5	V
Input high voltage	V _{IH}	2.2	—	V _{CC} + 0.3	V
Input low voltage	V _{IL}	- 0.3*	—	0.8	V

* V_{IL} = - 3.0V Min. for pulse width less than 50ns.

Electrical Characteristics

●DC and operating characteristics

(V_{CC} = 5V ± 10%, GND = 0V, T_a = 0 to +70°C)

Item	Symbol	Test conditions	- 70L/10L/12L - 70LL/10LL/12LL			Unit	
			Min.	Typ.*	Max.		
Input leak current	I _{LI}	V _{IN} = GND to V _{CC}	- 500	—	500	nA	
Output leak current	I _{LO}	V _{I/O} = GND to V _{CC} CE ₁ = V _{IH} or CE ₂ = V _{IL} or OE = V _{IH} or WE = V _{IL}	- 500	—	500	nA	
Operating supply current	I _{CC1}	CE ₁ = V _{IL} , CE ₂ = V _{IH} , V _{IN} = V _{IH} or V _{IL} , I _{OUT} = 0mA	—	8	15	mA	
Average operating current	I _{CC2}	Min. cycle Duty = 100%, I _{OUT} = 0mA	—	30	50	mA	
Standby current	I _{SB1}	CE ₂ ≤ 0.2V or { CE ₁ ≥ V _{CC} - 0.2V CE ₂ ≥ V _{CC} - 0.2V	- L	—	2	60	μA
			- LL	—	1	30	
	I _{SB2}	CE ₁ = V _{IH} or CE ₂ = V _{IL}	—	0.1	2	mA	
Output high voltage	V _{OH}	I _{OH} = - 1.0mA	2.4	—	—	V	
Output low voltage	V _{OL}	I _{OL} = 2.1mA	—	—	0.4	V	

* V_{CC} = 5V, T_a = 25°C

Pin capacitance

(T_a = 25°C, f = 1MHz)

Item	Symbol	Test conditions	Min.	Max.	Unit
Input capacitance	C _{IN}	V _{IN} = 0V	—	7	pF
Input/Output capacitance	C _{I/O}	V _{I/O} = 0V	—	7	pF

Note) This parameter is sampled and is not 100% tested.

AC characteristics

●AC test conditions (V_{CC} = 5V ± 10%, T_a = 0 to +70°C)

Item	Conditions
Input pulse high level	V _{IH} = 2.2V
Input pulse low level	V _{IL} = 0.8V
Input rise time	t _r = 5ns
Input fall time	t _f = 5ns
Input and output reference level	1.5V
Output load conditions	10L/10LL/12L/12LL
	70L/70LL
	C _L * = 100pF, 1TTL
	C _L * = 30pF, 1TTL

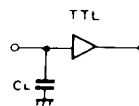
* C_L includes scope and jig capacitances.

● Read cycle

Item	Symbol	- 70L/70LL		- 10L/10LL		- 12L/12LL		Unit
		Min.	Max.	Min.	Max.	Min.	Max.	
Read cycle time	t _{RC}	70	—	100	—	120	—	ns
Address access time	t _{AA}	—	70	—	100	—	120	ns
Chip enable access time ($\overline{CE1}$, CE2)	t _{CO1} t _{CO2}	—	70	—	100	—	120	ns
Output enable to output valid	t _{OE}	—	35	—	50	—	60	ns
Output hold from address change	t _{OH}	10	—	10	—	10	—	ns
Chip enable to output in low Z ($\overline{CE1}$, CE2)	t _{LZ1} t _{LZ2}	10	—	10	—	10	—	ns
Output enable to output in low Z (\overline{OE})	t _{OLZ}	5	—	5	—	5	—	ns
Chip disable to output in high Z (CE1, CE2)	t _{HZ1} * t _{HZ2} *	0	30	0	35	0	45	ns
Output disable to output in high Z (\overline{OE})	t _{OHZ} *	0	30	0	35	0	45	ns

* t_{HZ1}, t_{HZ2} and t_{OHZ} are defined as the time at which the outputs become the high impedance state and are not referred to output voltage levels.

● Write cycle

Item	Symbol	- 70L/70LL		- 10L/10LL		- 12L/12LL		Unit
		Min.	Max.	Min.	Max.	Min.	Max.	
Write cycle time	t _{WC}	70	—	100	—	120	—	ns
Address valid to end of write	t _{AW}	60	—	80	—	85	—	ns
Chip enable to end of write	t _{CW}	60	—	80	—	85	—	ns
Data to write time overlap	t _{DW}	30	—	35	—	50	—	ns
Data hold from write time	t _{DH}	0	—	0	—	0	—	ns
Write pulse width	t _{WP}	40	—	60	—	70	—	ns
Address setup time	t _{AS}	0	—	0	—	0	—	ns
Write recovery time (\overline{WE})	t _{WR}	0	—	0	—	0	—	ns
Write recovery time ($\overline{CE1}$, CE2)	t _{WR1}	0	—	0	—	0	—	ns
Output active from end of write	t _{OW}	5	—	5	—	5	—	ns
Write to output in high Z	t _{WHZ} *	0	30	0	35	0	45	ns

* t_{WHZ} is defined as the time at which the outputs become the high impedance state and are not referred to output voltage levels.

Timing Waveform

- Read cycle (1) : $\overline{CE1} = \overline{OE} = V_{IL}$, $CE2 = V_{IH}$, $\overline{WE} = V_{IH}$

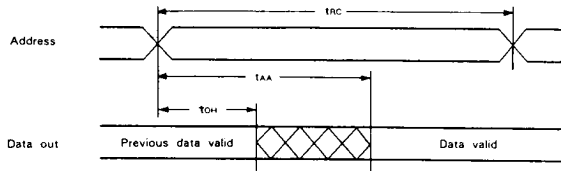

- Read cycle (2) : $\overline{WE} = V_{IH}$

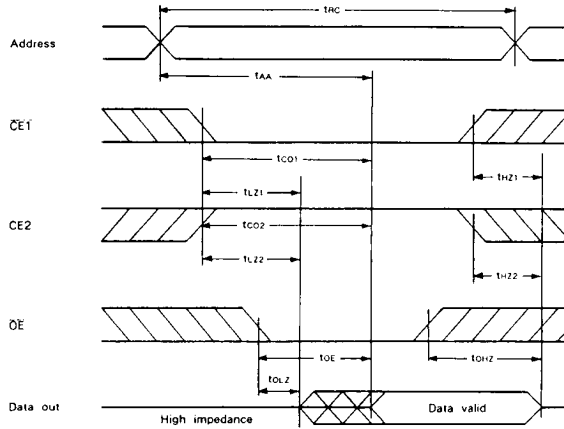

- Write cycle (1) : \overline{WE} control

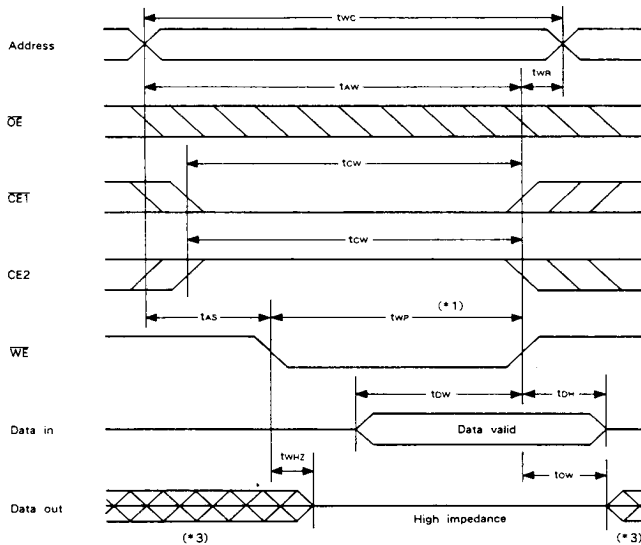

• Write cycle (2) : $\overline{CE1}$ control

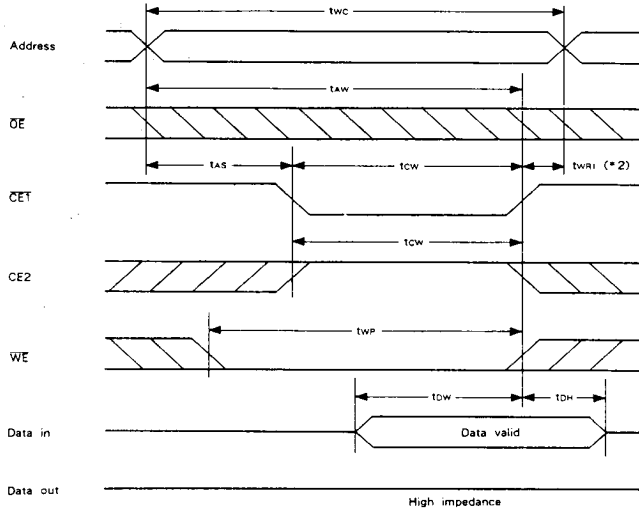

• Write cycle (3) : CE2 control

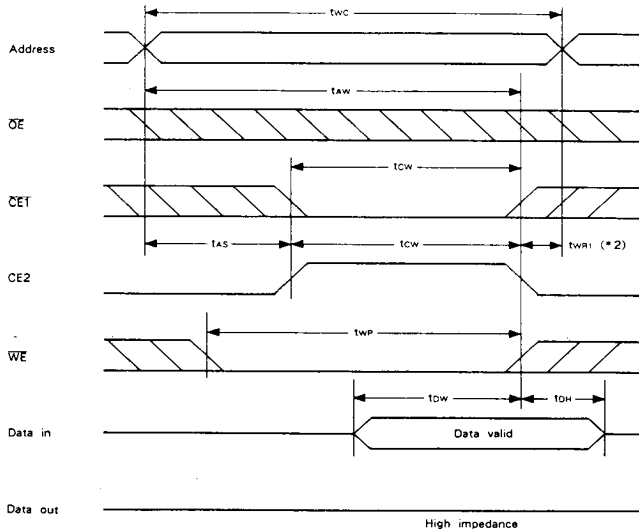

Note)

- * 1. Write is executed when both $\overline{CE1}$ and \overline{WE} are at low and CE2 is at high simultaneously.
- * 2. t_{WR1} is tested from either the rising edge of $\overline{CE1}$ or the falling edge of CE2, whichever comes earlier, until the end of the write cycle.
- * 3. Do not apply the data input voltage of the opposite phase to the output while the I/O pin is in output condition.

Data Retention Characteristics

(Ta = 0 to +70°C)

Item	Symbol	Test conditions	-70L/10L/12L			-70LL/10LL/12LL			Unit
			Min.	Typ.	Max.	Min.	Typ.	Max.	
Data retention voltage	V _{DR}	*1	2.0	—	5.5	2.0	—	5.5	V
Data retention current	I _{CCDR1}	*1	—	1	35	—	0.5	15	μA
		Ta = 0°C to 70°C	—	—	—	—	—	3	
	I _{CCDR2}	V _{CC} = 3.0V	—	—	—	—	—	—	—
		V _{CC} = 2.0 to 5.5V, *1	—	2	60	—	1	30	μA
Data retention setup time	t _{CDRS}	Chip disable to data retention mode	0	—	—	0	—	—	ns
Recovery time	t _R		t _{RC} *2	—	—	t _{RC} *2	—	—	ns

* 1. CE1 ≥ V_{CC} - 0.2V, CE2 ≥ V_{CC} - 0.2V [CE1 Control] or CE2 ≤ 0.2V [CE2 Control]

* 2. t_{RC} : Read cycle time

Data Retention Waveform

1. CE1 control

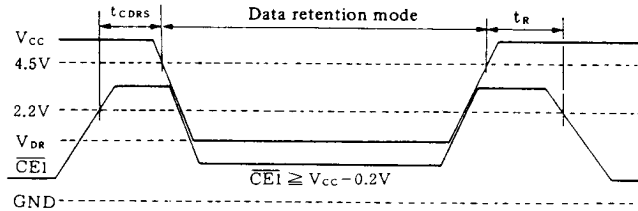

2. CE2 control

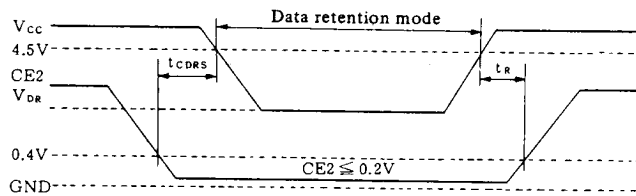

Example of Representative Characteristics

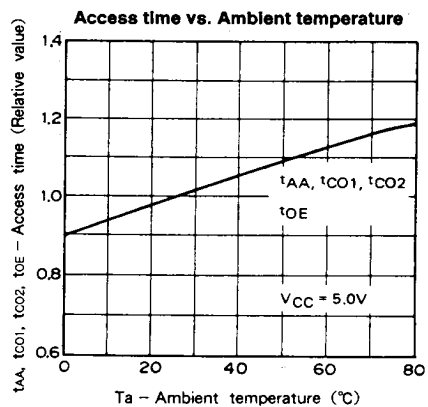
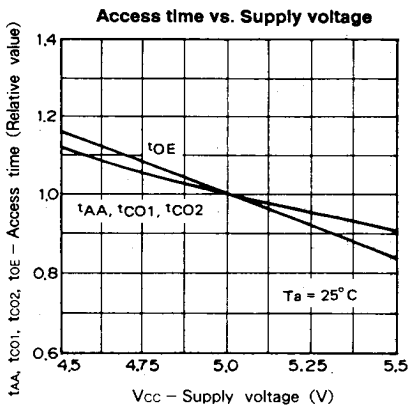
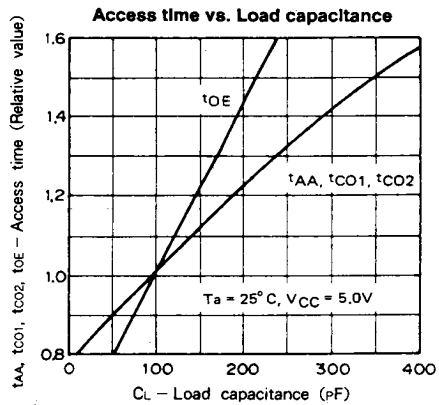
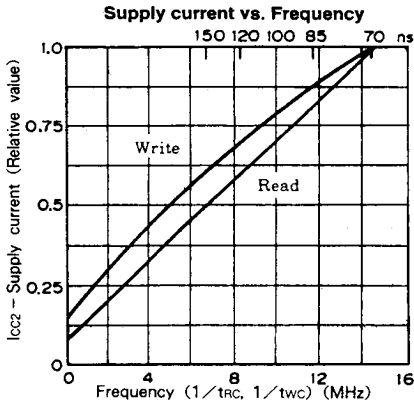
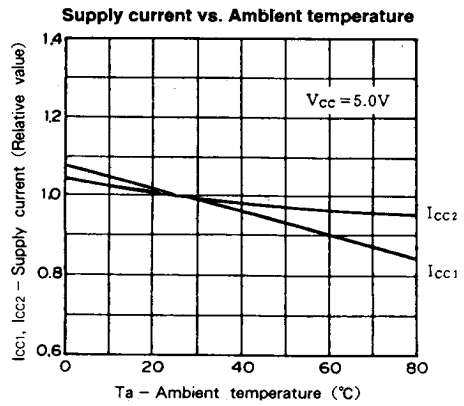
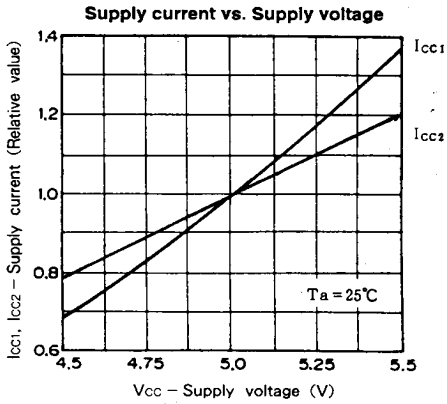

5

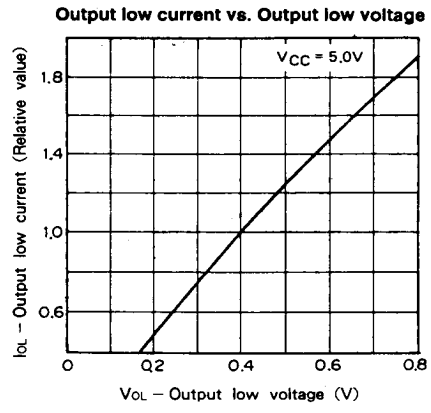
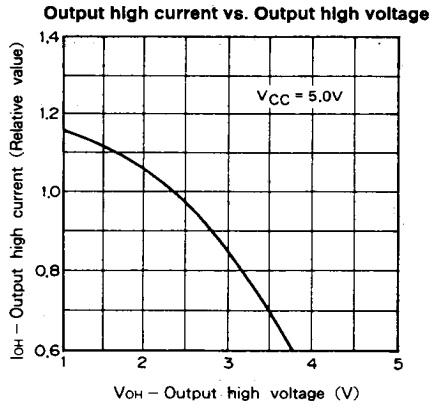
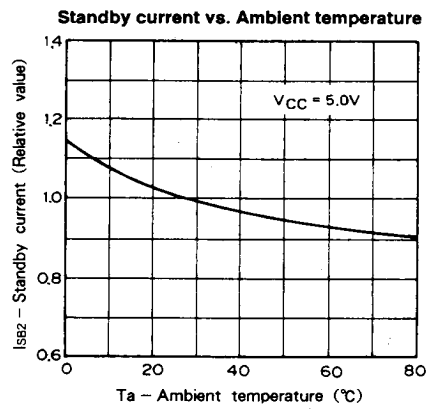
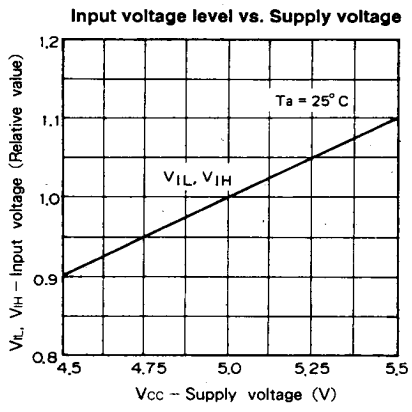
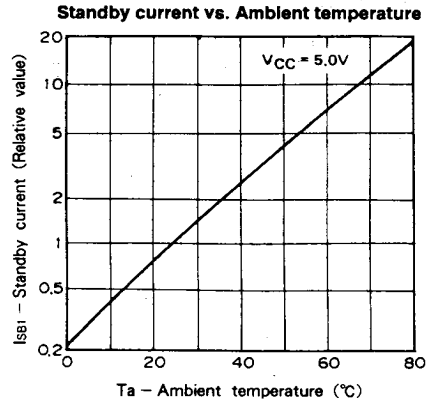
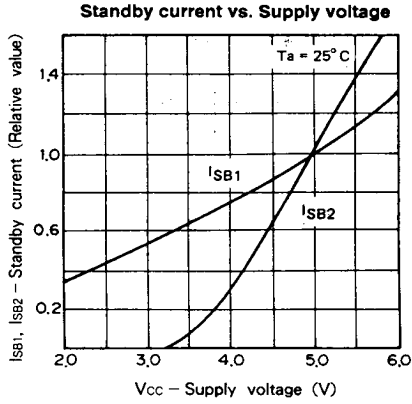

Package Outline Unit : mm

CXK5864BP 28 pin DIP (Plastic) 600mil 4.2g

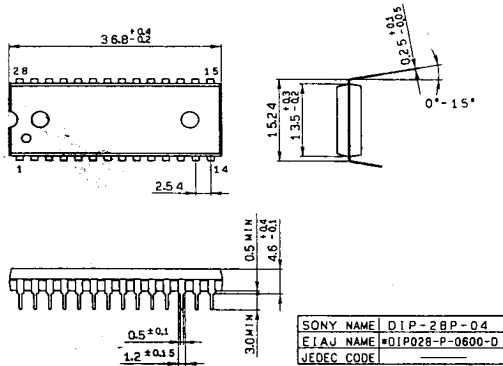

CXK5864BSP 28 pin DIP (Plastic) 300mil 2.0g

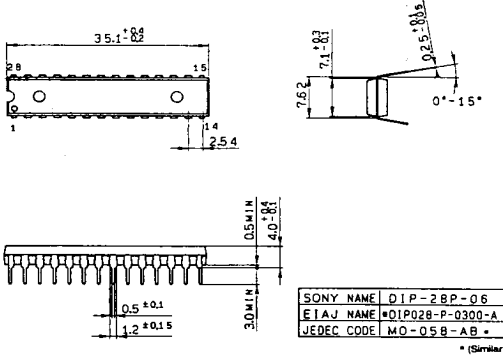

CXK5864BM 28 pin SOP (Plastic) 450mil 0.7g

