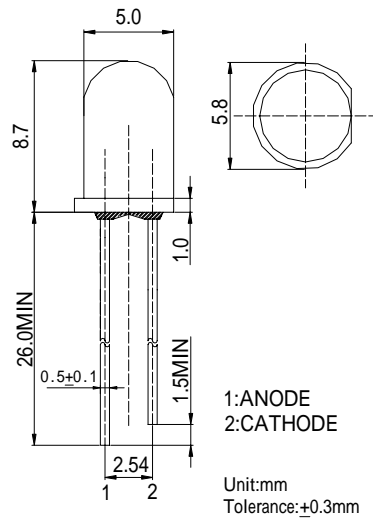

**■Features**

- High Luminous LEDs
- 5mm Standard Directivity
- Superior Weather-resistance
- UV Resistant Epoxy
- Water Clear Type

**■Applications**

- Automotive Dashboard Lighting
- Money Detector
- Back Lighting
- Other Lighting

**■Outline Dimension**

**■Absolute Maximum Rating**

(Ta=25 )

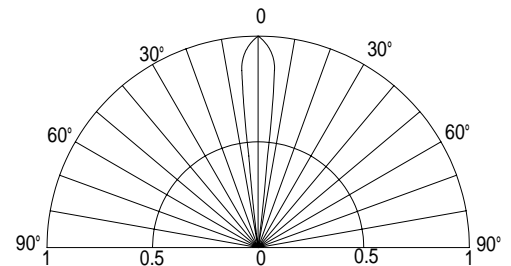
Item	Symbol	Value	Unit
DC Forward Current	$I_F$	30	mA
Pulse Forward Current*	$I_{FP}$	100	mA
Reverse Voltage	$V_R$	5	V
Power Dissipation	$P_D$	114	mW
Operating Temperature	$T_{opr}$	-30 ~ +85	
Storage Temperature	$T_{stg}$	-40 ~ +100	
Lead Soldering Temperature	$T_{sol}$	260 /5sec	-

**■Directivity**

\*Pulse width Max.10ms Duty ratio max 1/10

**■Electrical -Optical Characteristics**

(Ta=25 )

Item	Symbol	Condition	Min.	Typ.	Max.	Unit
DC Forward Voltage	$V_F$	$I_F=20mA$	3.0	3.4	3.8	V
DC Reverse Current	$I_R$	$V_R=5V$	-	-	10	$\mu A$
Peak Wavelength	$\lambda_p$	$I_F=20mA$	390	395	400	nm
Radiant flux*	$e$	$I_F=20mA$	2.0	5.0	6.0	mW
50% Power Angle	$2\theta_{1/2}$	$I_F=20mA$	-	15	-	deg

 \*1 Tolerance of dominant wavelength is  $\pm 1nm$ 

 \*2 Tolerance of Radiant flux is  $\pm 15\%$