

FUJI POWER MOSFET Super FAP-G Series

N-CHANNEL SILICON POWER MOSFET

Features

- High speed switching
- Low on-resistance
- No secondary breakdown
- Low driving power
- Avalanche-proof

Applications

- Switching regulators
- UPS (Uninterruptible Power Supply)
- DC-DC converters

Maximum ratings and characteristic Absolute maximum ratings

(Tc=25°C unless otherwise specified)

Item	Symbol	Ratings	Unit
Drain-source voltage	V _{DS}	250	V
	V _{DSX} *5	220	V
Continuous drain current	I _D	±14	A
Pulsed drain current	I _{D(puls)}	±56	A
Gate-source voltage	V _{GS}	±30	V
Non-repetitive Avalanche current	I _{AS} *2	14	A
Maximum Avalanche Energy	E _{AS} *1	129.1	mJ
Maximum Drain-Source dV/dt	dV _{DS} /dt *4	20	kV/μs
Peak Diode Recovery dV/dt	dV/dt *3	5	kV/μs
Max. power dissipation	P _D	T _a =25°C	2.02
		T _c =25°C	105
Operating and storage temperature range	T _{ch}	+150	°C
	T _{stg}	-55 to +150	°C

*1 L=1.11mH, V_{CC}=48V, T_{ch}=25°C, See to Avalanche Energy Graph *2 T_{ch} ≤150°C

*3 I_F ≤ -I_D, -di/dt=50A/μs, V_{CC} ≤ BV_{DSS}, T_{ch} ≤ 150°C *4 V_{DS} ≤ 250V *5 V_{GS}=-30V

Electrical characteristics (Tc =25°C unless otherwise specified)

Item	Symbol	Test Conditions	Min.	Typ.	Max.	Units
Drain-source breakdown voltage	V _{(BR)DSS}	I _D =250μA V _{GS} =0V	250			V
Gate threshold voltage	V _{GS(th)}	I _D =250μA V _{bs} =V _{gs}	3.0		5.0	V
Zero gate voltage drain current	I _{DSS}	V _{DS} =250V V _{GS} =0V			25	μA
		V _{DS} =200V V _{GS} =0V			250	
Gate-source leakage current	I _{GSS}	V _{GS} =±30V V _{DS} =0V		10	100	nA
Drain-source on-state resistance	R _{DS(on)}	I _D =5A V _{GS} =10V		200	260	mΩ
Forward transconductance	g _{fs}	I _D =5A V _{DS} =25V	5	10		S
Input capacitance	C _{iss}	V _{DS} =75V		785	1178	pF
Output capacitance	C _{oss}	V _{GS} =0V		88	132	
Reverse transfer capacitance	C _{rss}	f=1MHz		4	6	
Turn-on time t _{on}	t _{d(on)}	V _{CC} =48V I _D =5A		12	18	ns
	t _r	V _{GS} =10V		2.7	4.1	
Turn-off time t _{off}	t _{d(off)}	R _{GS} =10 Ω		22	33	
	t _f			7.4	11.1	
Total Gate Charge	Q _G	V _{CC} =125V		21	31.5	nC
Gate-Source Charge	Q _{GS}	I _D =10A		8	12	
Gate-Drain Charge	Q _{GD}	V _{GS} =10V		5	7.5	
Avalanche capability	I _{AV}	L=1.11mH T _{ch} =25°C	14			A
Diode forward on-voltage	V _{SD}	I _F =10A V _{GS} =0V T _{ch} =25°C		1.10	1.65	V
Reverse recovery time	t _{rr}	I _F =10A V _{GS} =0V		0.155		μs
Reverse recovery charge	Q _{rr}	-di/dt=100A/μs T _{ch} =25°C		1.05		μC

Thermal characteristics

Item	Symbol	Test Conditions	Min.	Typ.	Max.	Units
Thermal resistance	R _{th(ch-c)}	channel to case			1.191	°C/W
	R _{th(ch-a)}	channel to ambient			75.0	°C/W

Outline Drawings (mm)

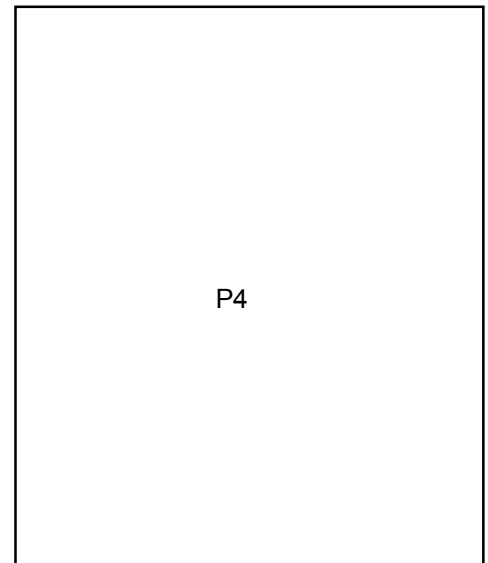

Equivalent circuit schematic

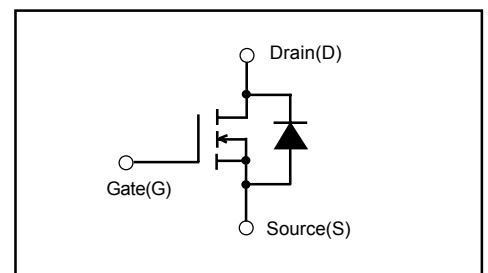

Characteristics

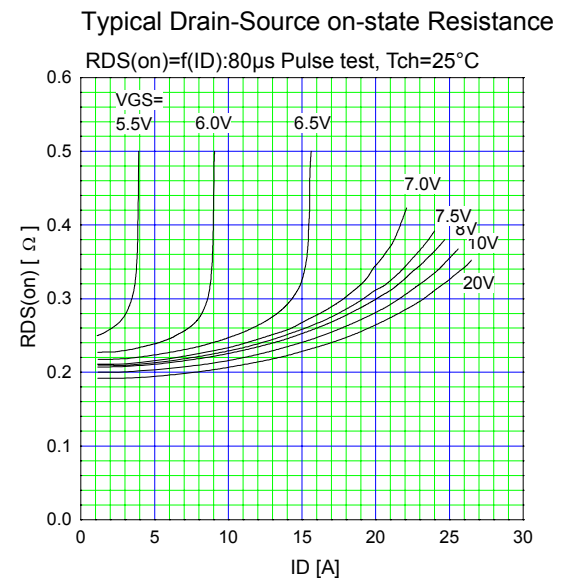
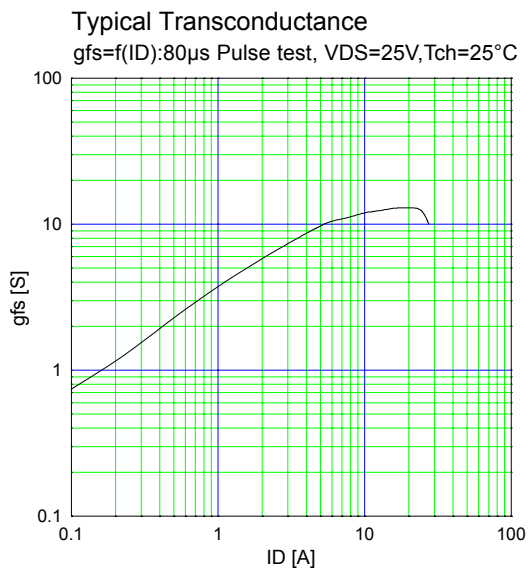
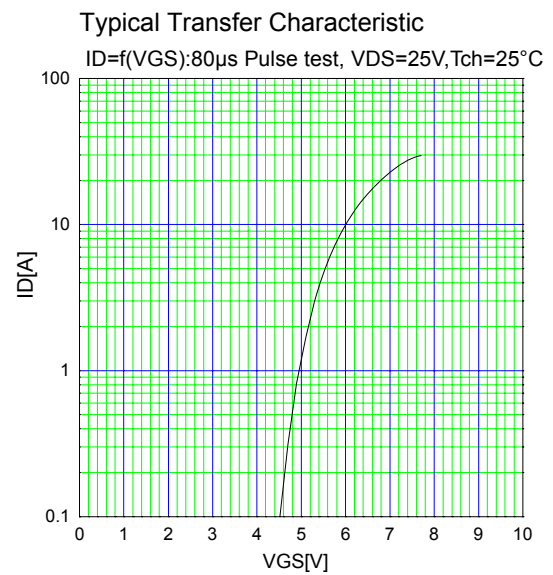
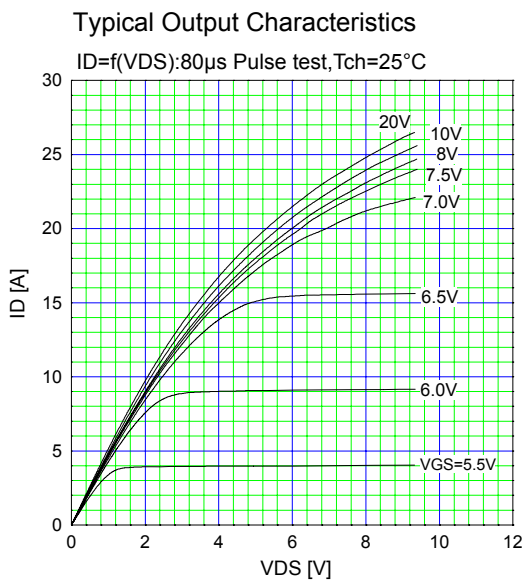
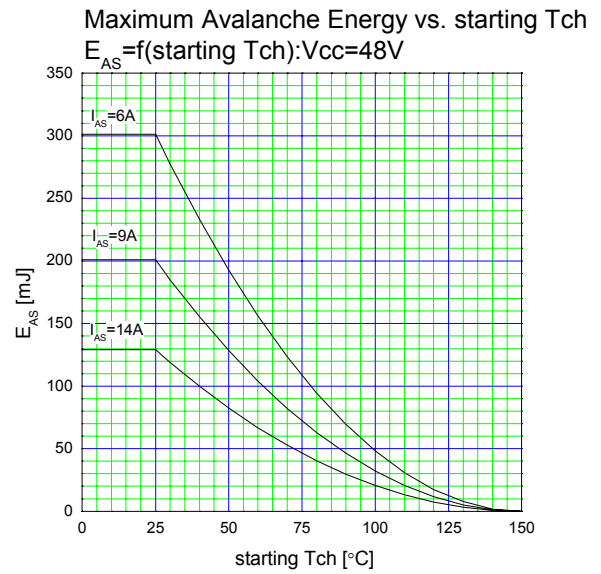
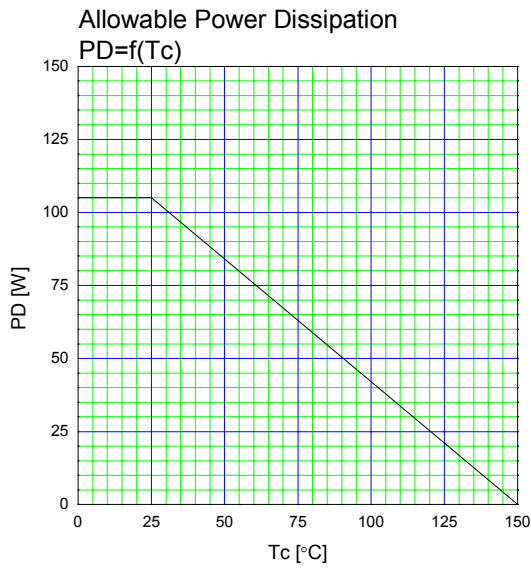

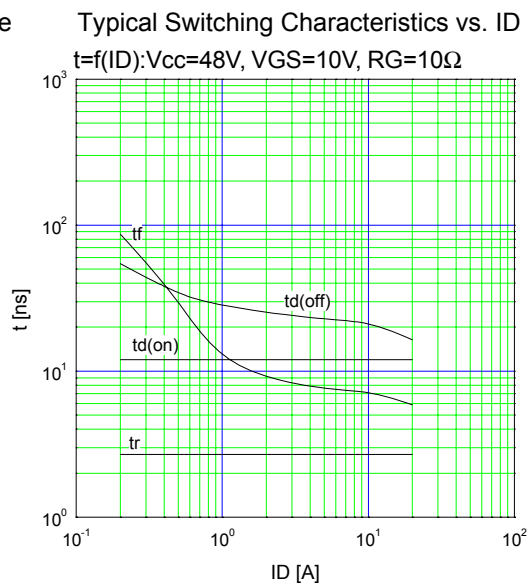
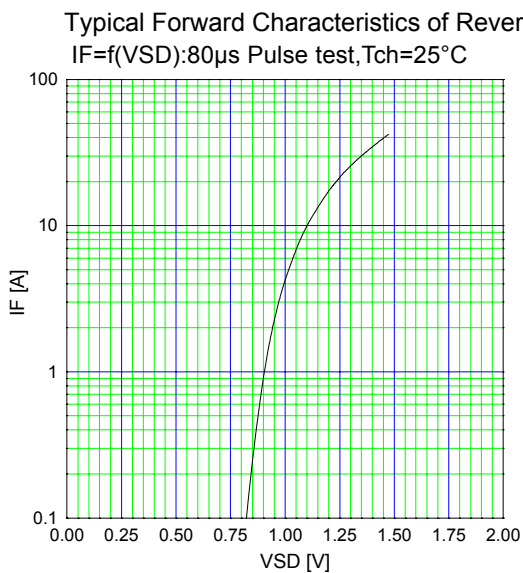
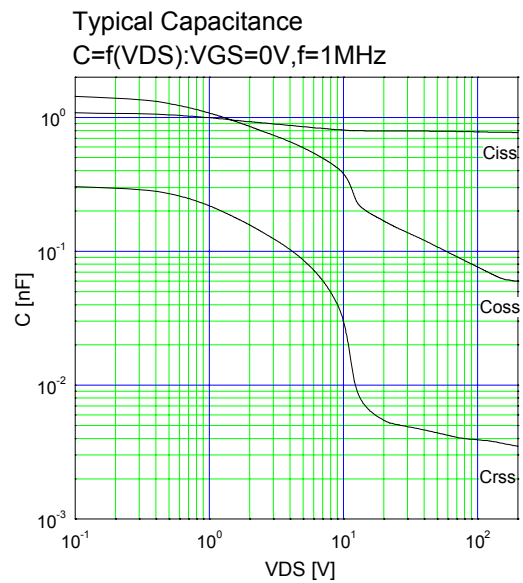
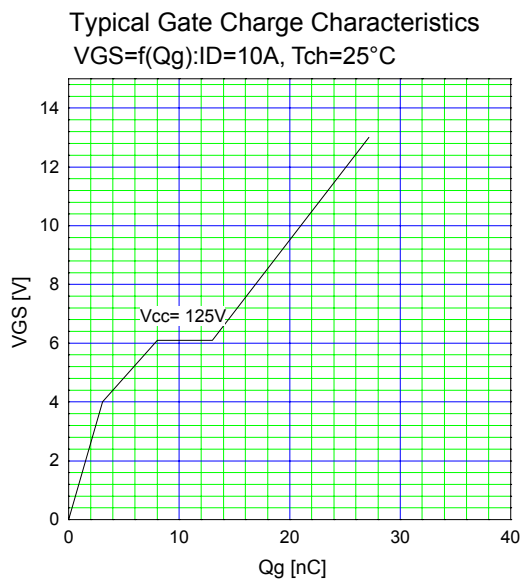
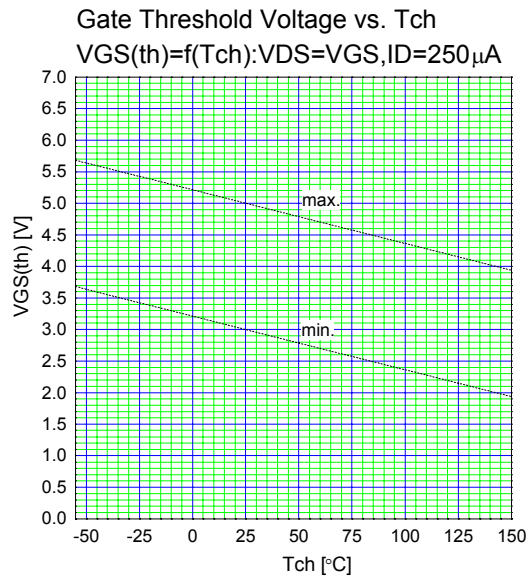
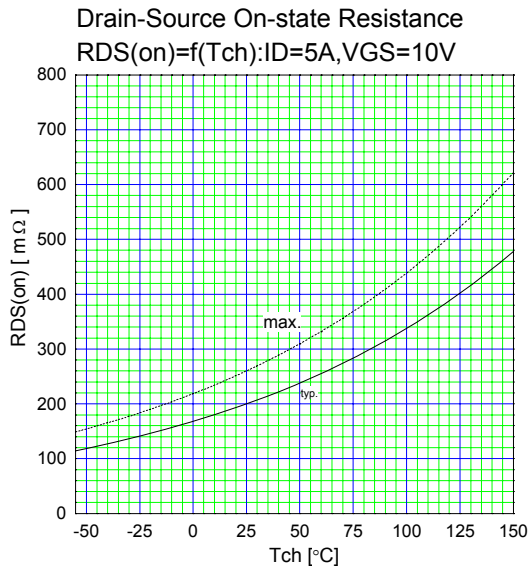

Maximum Avalanche Current vs Pulse width

$I_{AV} = f(t_{AV}); \text{starting } T_{ch} = 25^{\circ}\text{C}, V_{CC} = 48\text{V}$

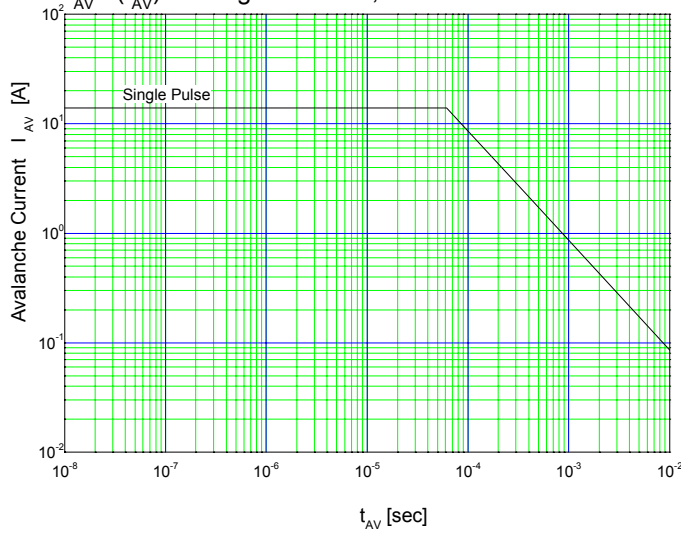

Maximum Transient Thermal Impedance

$Z_{th(ch-c)} = f(t); D = 0$

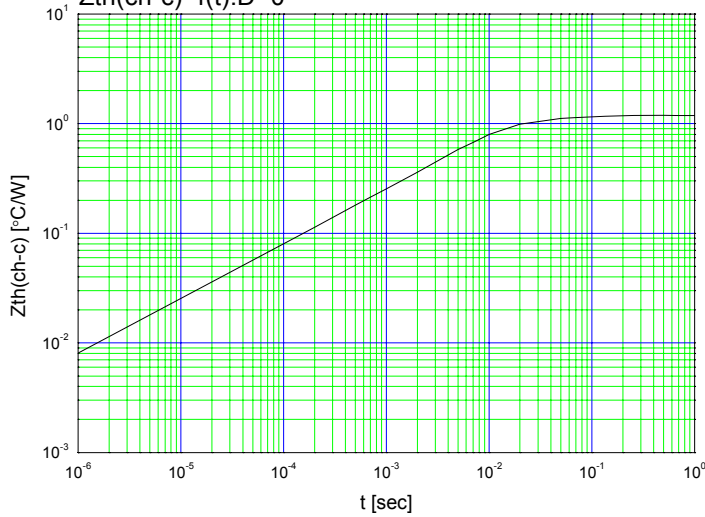

Outline Drawings (mm)

Type(L)

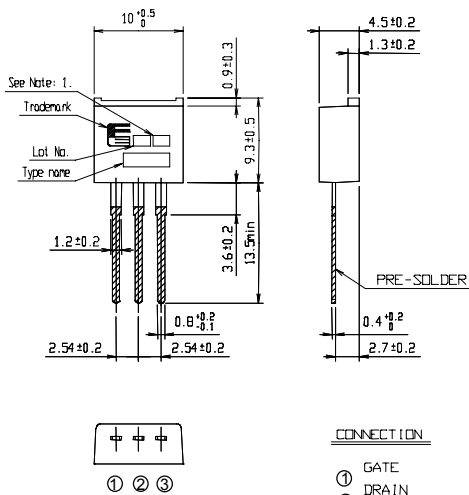

Type(S)

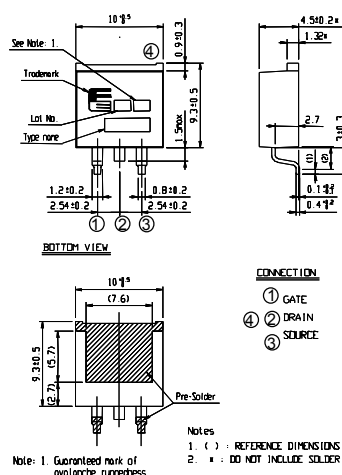

Type(SJ)

