

# High Precision Operational Amplifier Monolithic IC MM6558 Series

## Outline

This IC is a high precision operational amplifier, which is pin compatible with general use operational amplifier 4558, and has greatly improved input offset voltage and drift voltage. The offset is much smaller than for a general use operational amplifier, so offset adjustment is not needed. This contributes to reduction in the number of processes. Also, drift relative to stress is greatly reduced, so there is much less effect of stress due to IC strain and the like.

www.DataSheet4U.com

## Features

1. Low input offset voltage	$\pm$ power supply	0.1mV typ.	(MM6558, MM6559, MM6560, MM6561, MM6572)
	single power supply	0.2mV typ.	(MM6564, MM6565)
2. Low input offset drift	$\pm$ power supply	$\pm 1\mu\text{V}/^\circ\text{C}$ typ.	(MM6558, MM6559, MM6560, MM6561, MM6572)
	single power supply	$\pm 2\mu\text{V}/^\circ\text{C}$ typ.	(MM6564, MM6565)
3. Current consumption	$\pm$ power supply	3.0mA typ.	(MM6558, MM6559)
		3.5mA typ.	(MM6560, MM6572)
		1.7mA typ.	(MM6561)
	single power supply	0.35mA typ.	(MM6564)
4. Through rate	$\pm$ power supply	3V/ $\mu\text{S}$	(MM6558, MM6559, MM6560, MM6561)
		6V/ $\mu\text{S}$	(MM6572)
	single power supply	1V/ $\mu\text{S}$	(MM6564, MM6565)
		0.35mA typ.	(MM6565)
5. Input conversion interference voltage	$\pm$ power supply	1.2 $\mu\text{Vrms}$	(MM6558, MM6559, MM6560, MM6561)
		0.5 $\mu\text{Vrms}$	(MM6572)
	single power supply	1.8 $\mu\text{Vrms}$	(MM6564)
		2.0 $\mu\text{Vrms}$	(MM6565)

## Package

- SOP-8C, SOP-8E (MM65 $\times\times\times$ F)
- DIP-8B (MM65 $\times\times\times$ D)
- SIP-8A (MM65 $\times\times\times$ S)

## Applications

- Office automation equipment
- measurement equipment
- sensor equipment

MM6558

**Absolute Maximum Ratings** (Ta=25°C)

Item	Symbol	Rating	Units
Storage temperature	T <sub>STG</sub>	-40~+125	°C
Operating temperature	T <sub>OPR</sub>	-20~+75	°C
Power supply voltage	V <sup>+</sup> /V <sup>-</sup>	±12	V
Allowable power dissipation	P <sub>d</sub>	300	mW
Differential input voltage	V <sub>ID</sub>	±20	V
Input voltage	V <sub>I</sub>	±10	V

www.DataSheet4U.com

**Electrical Characteristics** (Unless otherwise specified Ta=25°C, V<sup>+</sup>/V<sup>-</sup>=±10V)

Item	Symbol	Measurement Conditions	Min.	Typ.	Max.	Units
Operating power supply voltage range			±3.5		±11	V
Input offset voltage	V <sub>IO</sub>	R <sub>S</sub> ≤ 10kΩ		0.1	0.5	mV
Input offset voltage temperature drift	ΔV <sub>IO</sub>			±1		μV/°C
Input offset current	I <sub>IO</sub>			5	200	nA
Input bias current	I <sub>B</sub>			50	500	nA
Input resistance	R <sub>IN</sub>		0.3	3		MΩ
In-phase input voltage	V <sub>CM</sub>		±8	±9		V
Voltage gain	A <sub>v</sub>	R <sub>L</sub> ≥ 2kΩ, V <sub>0</sub> =±7V	86	100		dB
Maximum output voltage	V <sub>O</sub>	R <sub>L</sub> ≥ 10kΩ	±8	±9		V
In-phase signal elimination ratio	CMRR	R <sub>S</sub> ≤ 10kΩ	70	90		dB
Power supply voltage elimination ratio	PSRR	R <sub>S</sub> ≤ 10kΩ	76.5	90		dB
Current consumption	I <sub>CC</sub>			3.0	5.0	mA
Output flow current	I <sub>SO</sub>		13			mA
Output inflow current	I <sub>SI</sub>		13			mA
Through rate	SR	R <sub>L</sub> ≥ 2kΩ		3		V/μS
Gain band area	GBW			7		MHz
Input conversion interference voltage	e <sub>n</sub>	R <sub>S</sub> =300Ω, IHFA (A curve)		1.2		μV <sub>rms</sub>

MM6559

**Absolute Maximum Ratings** (Ta=25°C)

Item	Symbol	Rating	Units
Storage temperature	T <sub>STG</sub>	-40~+125	°C
Operating temperature	T <sub>OPR</sub>	-20~+75	°C
Power supply voltage	V <sup>+</sup> /V <sup>-</sup>	±12	V
Allowable power dissipation	P <sub>d</sub>	300	mW
Differential input voltage	V <sub>ID</sub>	±20	V
Input voltage	V <sub>I</sub>	±10	V

www.DataSheet4U.com

**Electrical Characteristics** (Unless otherwise specified Ta=25°C, V<sup>+</sup>/V<sup>-</sup>=±10V)

Item	Symbol	Measurement Conditions	Min.	Typ.	Max.	Units
Operating power supply voltage range			±2		±11	V
Input offset voltage	V <sub>IO</sub>	R <sub>S</sub> ≤ 10kΩ		0.1	0.5	mV
Input offset voltage temperature drift	ΔV <sub>IO</sub>			±1		μV/°C
Input offset current	I <sub>IO</sub>			5	200	nA
Input bias current	I <sub>B</sub>			50	500	nA
Input resistance	R <sub>IN</sub>		0.3	3		MΩ
In-phase input voltage	V <sub>CM</sub>		±8	±9		V
Voltage gain	A <sub>v</sub>	R <sub>L</sub> ≥ 2kΩ, V <sub>O</sub> =±7V	86	100		dB
Maximum output voltage	V <sub>O</sub>	R <sub>L</sub> ≥ 10kΩ	±8	±9		V
In-phase signal elimination ratio	CMRR	R <sub>S</sub> ≤ 10kΩ	70	90		dB
Power supply voltage elimination ratio	PSRR	R <sub>S</sub> ≤ 10kΩ	76.5	90		dB
Current consumption	I <sub>CC</sub>			3.0	5.0	mA
Output flow current	I <sub>SO</sub>		13			mA
Output inflow current	I <sub>SI</sub>		13			mA
Through rate	SR	R <sub>L</sub> ≥ 2kΩ		3		V/μS
Gain band area	GBW			7		MHz
Input conversion interference voltage	e <sub>n</sub>	R <sub>S</sub> =300Ω, IHFA (Acurve)		1.2		μV <sub>rms</sub>

MM6560

**Absolute Maximum Ratings** (Ta=25°C)

Item	Symbol	Rating	Units
Storage temperature	T <sub>STG</sub>	-40~+125	°C
Operating temperature	T <sub>OPR</sub>	-20~+75	°C
Power supply voltage	V <sup>+</sup> /V <sup>-</sup>	±12	V
Allowable power dissipation	P <sub>d</sub>	300	mW
Differential input voltage	V <sub>ID</sub>	±20	V
Input voltage	V <sub>I</sub>	±10	V

www.DataSheet4U.com

**Electrical Characteristics** (Unless otherwise specified Ta=25°C, V<sup>+</sup>/V<sup>-</sup>=±10V)

Item	Symbol	Measurement Conditions	Min.	Typ.	Max.	Units
Operating power supply voltage range			±3.5		±11	V
Input offset voltage	V <sub>IO</sub>	R <sub>S</sub> ≤ 10kΩ		0.1	0.5	mV
Input offset voltage temperature drift	ΔV <sub>IO</sub>			±1		μV/°C
Input offset current	I <sub>IO</sub>			5	200	nA
Input bias current	I <sub>B</sub>			50	500	nA
Input resistance	R <sub>IN</sub>		0.3	3		MΩ
In-phase input voltage	V <sub>CM</sub>		±8	±9		V
Voltage gain	A <sub>v</sub>	R <sub>L</sub> ≥ 2kΩ, V <sub>O</sub> =±7V	86	100		dB
Maximum output voltage	V <sub>O</sub>	R <sub>L</sub> ≥ 2kΩ	±8	±9		V
In-phase signal elimination ratio	CMRR	R <sub>S</sub> ≤ 10kΩ	70	90		dB
Power supply voltage elimination ratio	PSRR	R <sub>S</sub> ≤ 10kΩ	76.5	90		dB
Current consumption	I <sub>CC</sub>			3.5	5.7	mA
Output flow current	I <sub>SO</sub>		25			mA
Output inflow current	I <sub>SI</sub>		25			mA
Through rate	SR	R <sub>L</sub> ≥ 2kΩ		3		V/μS
Gain band area	GBW			7		MHz
Input conversion interference voltage	e <sub>n</sub>	R <sub>S</sub> =300Ω, IHFA (A curve)		1.2		μV <sub>rms</sub>

MM6561

**Absolute Maximum Ratings** (Ta=25°C)

Item	Symbol	Rating	Units
Storage temperature	T <sub>STG</sub>	-40~+125	°C
Operating temperature	T <sub>OPR</sub>	-20~+75	°C
Power supply voltage	V <sup>+</sup> /V <sup>-</sup>	±12	V
Allowable power dissipation	P <sub>d</sub>	300	mW
Differential input voltage	V <sub>ID</sub>	±20	V
Input voltage	V <sub>I</sub>	±10	V

**Electrical Characteristics** (Unless otherwise specified Ta=25°C, V<sup>+</sup>/V<sup>-</sup>=±10V)

Item	Symbol	Measurement Conditions	Min.	Typ.	Max.	Units
Operating power supply voltage range			±3.5		±11	V
Input offset voltage	V <sub>IO</sub>	R <sub>S</sub> ≤ 10kΩ		0.1	0.5	mV
Input offset voltage temperature drift	ΔV <sub>IO</sub>			±1		μV/°C
Input offset current	I <sub>IO</sub>			5	200	nA
Input bias current	I <sub>B</sub>			50	500	nA
Input resistance	R <sub>IN</sub>		0.3	3		MΩ
In-phase input voltage	V <sub>CM</sub>		±8	±9		V
Voltage gain	A <sub>v</sub>	R <sub>L</sub> ≥ 5kΩ, V <sub>O</sub> =±7V	86	100		dB
Maximum output voltage	V <sub>O</sub>	R <sub>L</sub> ≥ 10kΩ	±8	±9		V
In-phase signal elimination ratio	CMRR	R <sub>S</sub> ≤ 10kΩ	70	90		dB
Power supply voltage elimination ratio	PSRR	R <sub>S</sub> ≤ 10kΩ	76.5	90		dB
Current consumption	I <sub>CC</sub>			1.7	2.7	mA
Output flow current	I <sub>SO</sub>		6			mA
Output inflow current	I <sub>SI</sub>		6			mA
Through rate	SR	R <sub>L</sub> ≥ 2kΩ		3		V/μS
Gain band area	GBW			7		MHz
Input conversion interference voltage	e <sub>n</sub>	R <sub>S</sub> =300Ω, IHFA (A curve)		1.2		μV <sub>rms</sub>

MM6564

**Absolute Maximum Ratings** (Ta=25°C)

Item	Symbol	Rating	Units
Storage temperature	T <sub>STG</sub>	-40~+125	°C
Operating temperature	T <sub>OPR</sub>	-20~+75	°C
Power supply voltage	V <sub>CC</sub> max.	15	V
Allowable power dissipation	P <sub>d</sub>	300	mW
Input voltage	V <sub>I</sub>	0~15	V

www.DataSheet4U.com

**Electrical Characteristics** (Unless otherwise specified Ta=25°C, V<sub>CC</sub>=3V, V<sub>I</sub>=1V)

Item	Symbol	Measurement Conditions	Min.	Typ.	Max.	Units
Operating power supply voltage range			2	3	13	V
Input offset voltage	V <sub>IO</sub>			0.2	0.9	mV
Input offset voltage temperature drift	ΔV <sub>IO</sub>			±2		μV/°C
Input offset current	I <sub>IO</sub>			5	30	nA
Input bias current	I <sub>B</sub>			30	150	nA
Input voltage range	V <sub>I</sub>		0		V <sub>CC</sub> -1	V
Voltage gain	A <sub>V</sub>	R <sub>L</sub> ≥ 100kΩ	80	100		dB
Output voltage range	V <sub>O</sub>		0.1		V <sub>CC</sub> -1	V
Output flow current	I <sub>SO</sub>		0.5			mA
In-phase signal elimination ratio	CMRR	R <sub>S</sub> ≤ 10kΩ	70	90		dB
Power supply voltage elimination ratio	PSRR	R <sub>S</sub> ≤ 10kΩ	76.5	90		dB
Current consumption	I <sub>CC</sub>			0.35	0.5	mA
Through rate	SR			1		V/μS
Gain band area	GBW			2		MHz
Input conversion interference voltage	e <sub>n</sub>	R <sub>S</sub> =300Ω, IHFA (A curve)		1.8		μV <sub>rms</sub>

MM6565

**Absolute Maximum Ratings** (Ta=25°C)

Item	Symbol	Rating	Units
Storage temperature	T <sub>STG</sub>	-40~+125	°C
Operating temperature	T <sub>OPR</sub>	-20~+75	°C
Power supply voltage	V <sub>CC</sub> max.	15	V
Allowable power dissipation	P <sub>d</sub>	300	mW
Input voltage	V <sub>I</sub>	0~15	V

www.DataSheet4U.com

**Electrical Characteristics** (Unless otherwise specified Ta=25°C, V<sub>CC</sub>=5V)

Item	Symbol	Measurement Conditions	Min.	Typ.	Max.	Units
Operating power supply voltage range			4	5	13	V
Input offset voltage	V <sub>IO</sub>			0.2	0.9	mV
Input offset voltage temperature drift	ΔV <sub>IO</sub>			±2		μV/°C
Input offset current	I <sub>IO</sub>			5	30	nA
Input bias current	I <sub>B</sub>			30	150	nA
Input voltage range	V <sub>I</sub>		0		V <sub>CC</sub> -1	V
Voltage gain	A <sub>V</sub>	R <sub>L</sub> ≥ 100kΩ	80	100		dB
Output voltage range	V <sub>O</sub>	R <sub>L</sub> ≥ 10kΩ	GND+1		V <sub>CC</sub> -1	V
Output flow current	I <sub>SO</sub>		0.5			mA
Output inflow current	I <sub>SI</sub>		0.5			mA
In-phase signal elimination ratio	CMRR	R <sub>S</sub> ≤ 10kΩ	70	90		dB
Power supply voltage elimination ratio	PSRR	R <sub>S</sub> ≤ 10kΩ	76.5	90		dB
Current consumption	I <sub>CC</sub>			0.35	0.5	mA
Through rate	SR	R <sub>L</sub> ≥ 10kΩ		1		V/μS
Gain band area	GBW			1		MHz
Input conversion interference voltage	e <sub>n</sub>	R <sub>S</sub> =300Ω, IHFA (A curve)		2.0		μV <sub>rms</sub>

MM6572

**Absolute Maximum Ratings** (Ta=25°C)

Item	Symbol	Rating	Units
Storage temperature	T <sub>STG</sub>	-40~+125	°C
Operating temperature	T <sub>OPR</sub>	-20~+75	°C
Power supply voltage	V <sup>+</sup> /V <sup>-</sup>	±12	V
Allowable power dissipation	P <sub>d</sub>	300	mW
Differential input voltage	V <sub>ID</sub>	±20	V
Input voltage	V <sub>I</sub>	±10	V

www.DataSheet4U.com

**Electrical Characteristics** (Unless otherwise specified Ta=25°C, V<sup>+</sup>/V<sup>-</sup>=±10V)

Item	Symbol	Measurement Conditions	Min.	Typ.	Max.	Units
Operating power supply voltage range			±2		±11	V
Input offset voltage	V <sub>IO</sub>	R <sub>S</sub> ≤ 10kΩ		0.1	0.5	mV
Input offset voltage temperature drift	ΔV <sub>IO</sub>			±1		μV/°C
Input offset current	I <sub>IO</sub>			10	100	nA
Input bias current	I <sub>B</sub>			200	500	nA
Input resistance	R <sub>IN</sub>		100	260		kΩ
In-phase input voltage	V <sub>CM</sub>		±8	±9		V
Voltage gain	A <sub>v</sub>	R <sub>L</sub> ≥ 2kΩ, V <sub>O</sub> =±7V	86	100		dB
Maximum output voltage	V <sub>O</sub>	R <sub>L</sub> ≥ 10kΩ	±8	±9		V
In-phase signal elimination ratio	CMRR	R <sub>S</sub> ≤ 10kΩ	70	90		dB
Power supply voltage elimination ratio	PSRR	R <sub>S</sub> ≤ 10kΩ	76.5	90		dB
Current consumption	I <sub>CC</sub>			3.5	5.0	mA
Output flow current	I <sub>SO</sub>		13			mA
Output inflow current	I <sub>SI</sub>		13			mA
Through rate	SR	R <sub>L</sub> ≥ 2kΩ		6		V/μS
Gain band area	GBW			10		MHz
Input conversion interference voltage	e <sub>n</sub>	R <sub>S</sub> =300Ω, IHFA (A curve)		0.5		μV <sub>rms</sub>



Pin Assignment

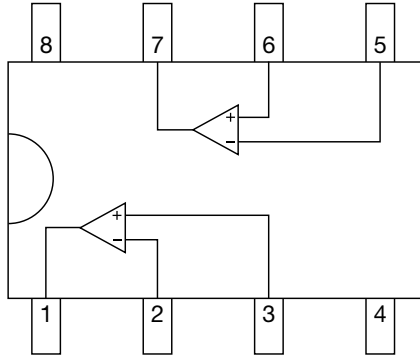

Pin No..	Pin Function	
	MM6558 MM6559 MM6560 MM6561 MM6572	MM6564 MM6565
1	A <sub>OUT</sub>	
2	A <sub>IN-</sub>	
3	A <sub>IN+</sub>	
4	V <sub>-</sub>	GND
5	B <sub>IN+</sub>	
6	B <sub>IN-</sub>	
7	B <sub>OUT</sub>	
8	V <sub>+</sub>	V <sub>CC</sub>

Characteristics

MM6558

■ Example of input calculation interference voltage relative to signal source resistance characteristics

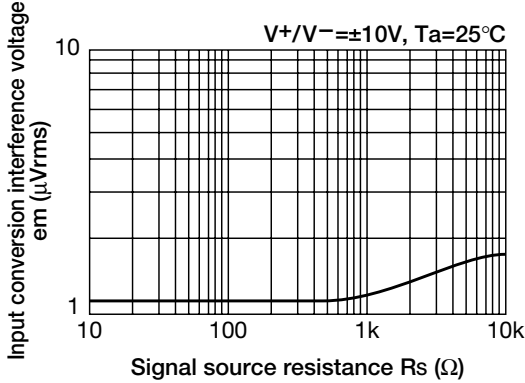

■ Example of input bias current relative to power supply voltage characteristics

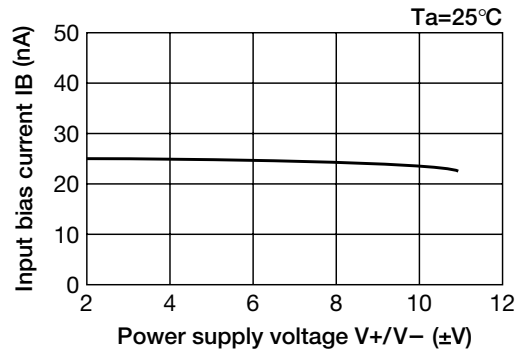

■ Example of input offset voltage relative to power supply voltage characteristics

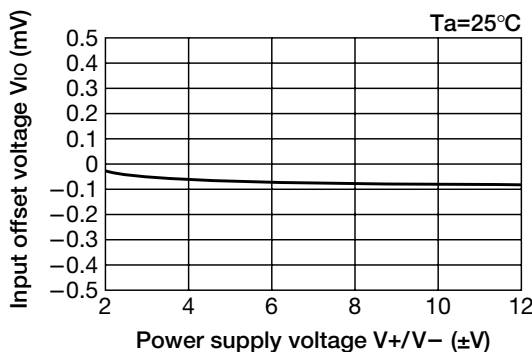

■ Example of current consumption relative to power supply voltage characteristics

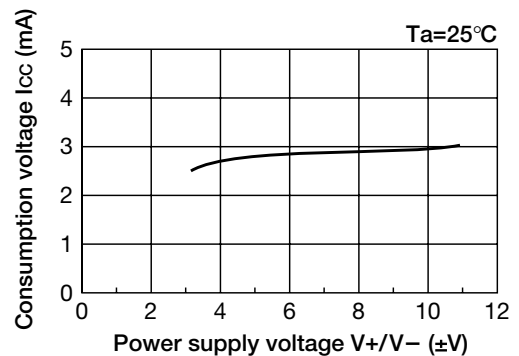

■ Example of input offset current to power supply voltage characteristics

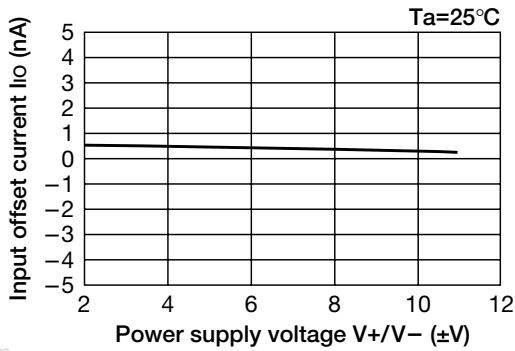

■ Example of complete higher harmonic distortion rate output voltage characteristics

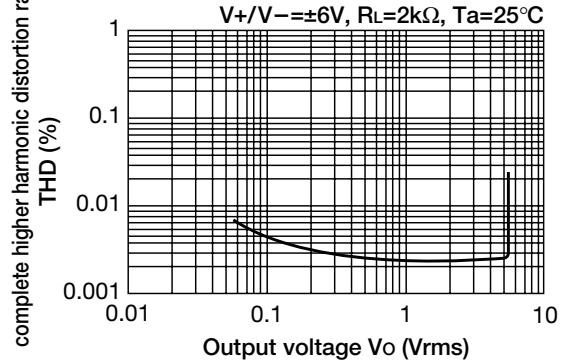

■ Example of power supply voltage elimination frequency characteristics

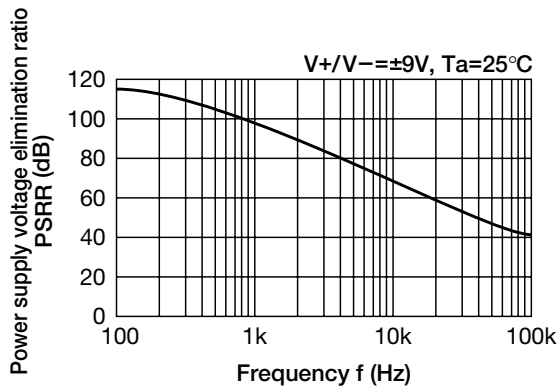

■ Example of maximum output voltage amplitude frequency characteristics

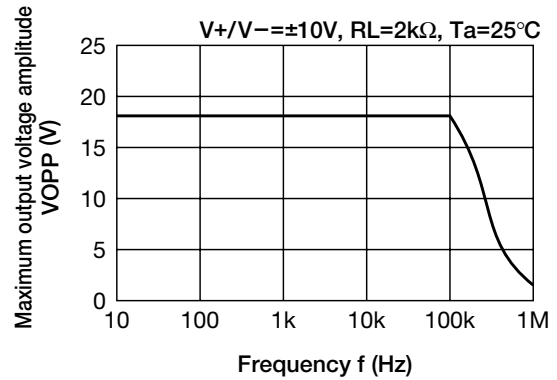

■ Example of maximum output voltage relative to power supply voltage characteristics

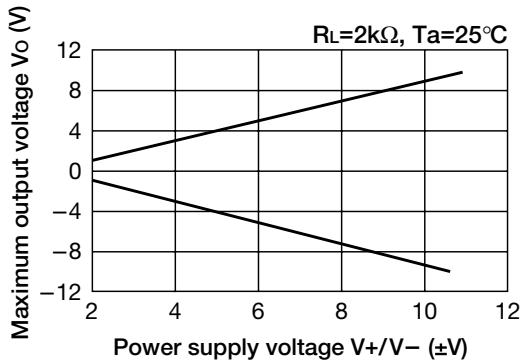

■ Example of voltage gain frequency characteristics

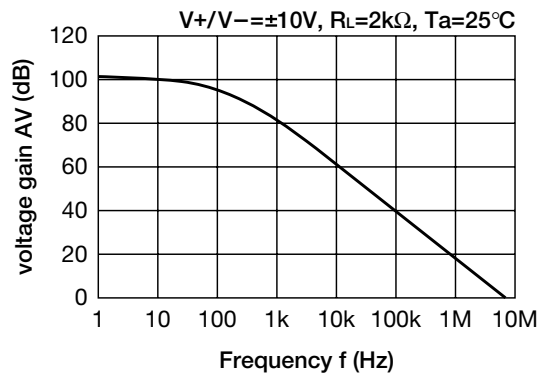

■ Example of maximum output voltage amplitude relative to load characteristics

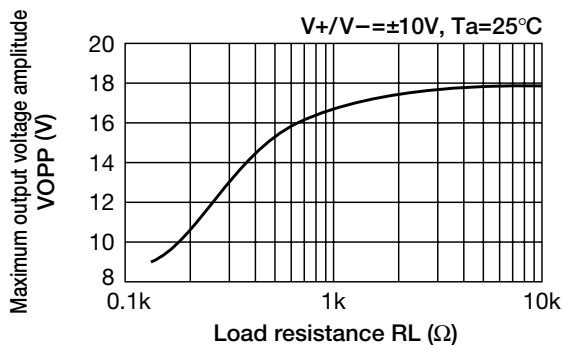

■ MM6559

■ Example of input offset voltage relative to power supply voltage characteristics

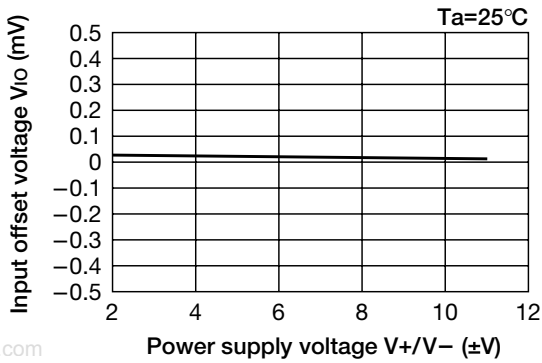

■ Example of current consumption relative to power supply voltage characteristics

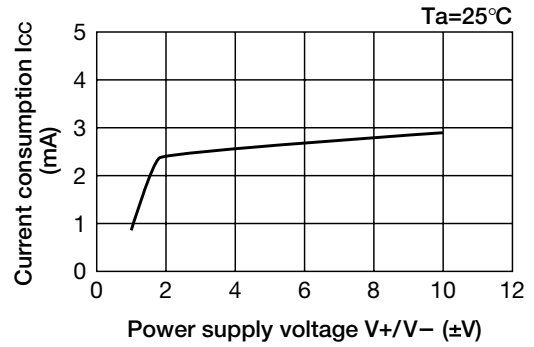

■ Comparison of input offset current relative to power supply voltage characteristics

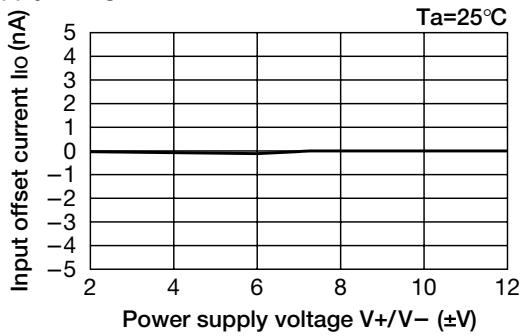

■ MM6561

■ Example of input offset voltage relative to power supply voltage characteristics

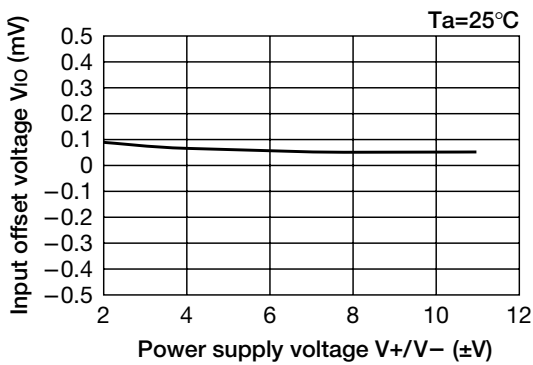

■ Example of current consumption relative to power supply voltage characteristics

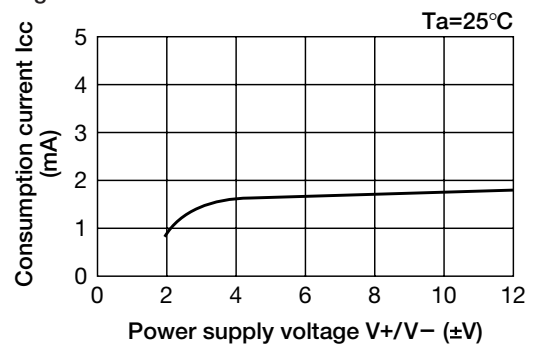

■ Example of offset current relative to power supply voltage characteristics

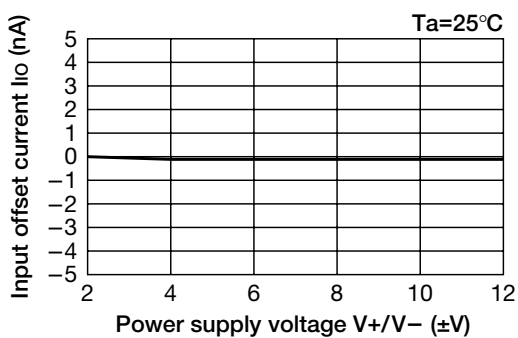

■ Example of maximum output voltage amplitude relative to load characteristics

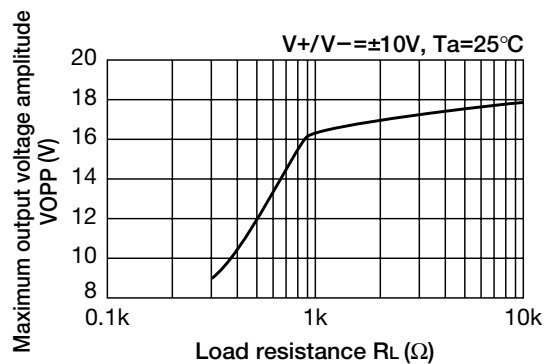

MM6564

Example of input calculation interference voltage relative to signal source resistance characteristics

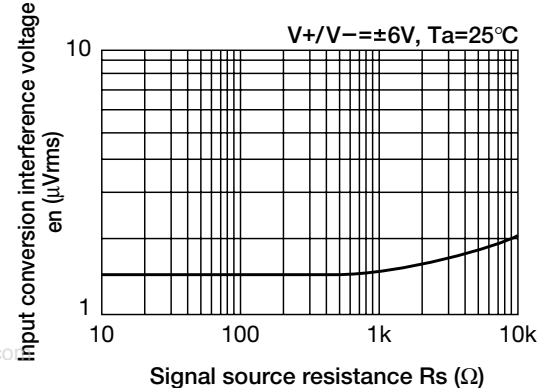

Example of input bias current relative to power supply voltage characteristics

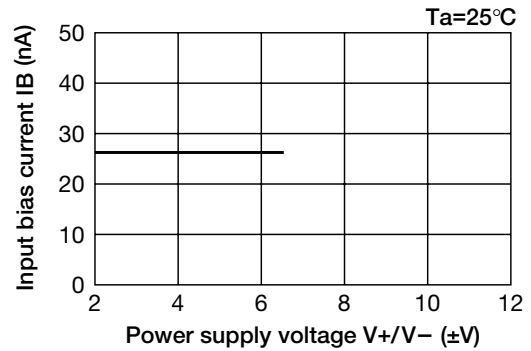

Example of input offset voltage relative to power supply voltage characteristics

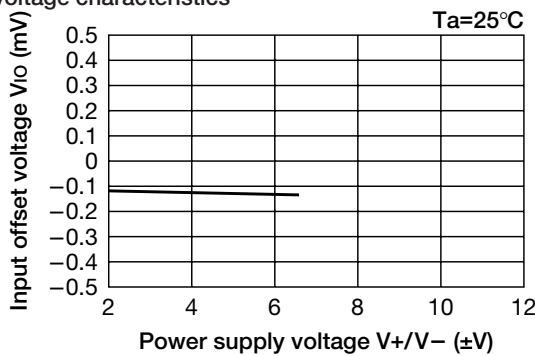

Comparison of input offset current relative to power supply voltage characteristics

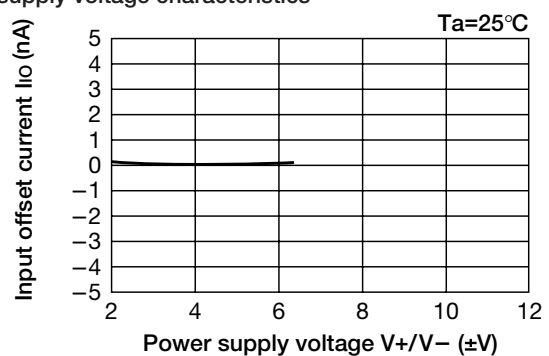

Example of complete higher harmonic distortion rate output voltage characteristics

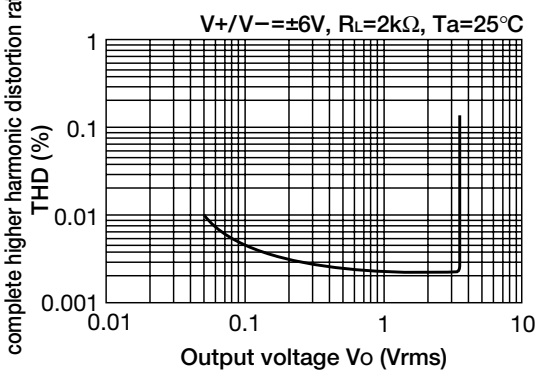

Example of power supply voltage elimination frequency characteristics

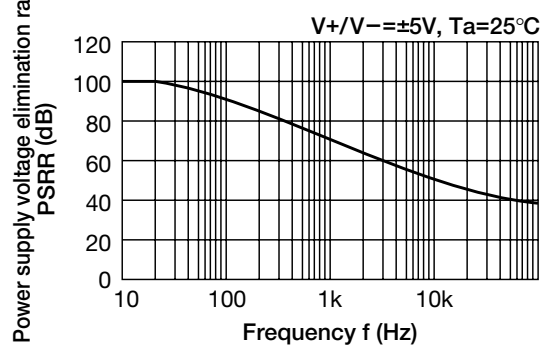

Example of maximum output voltage amplitude frequency characteristics

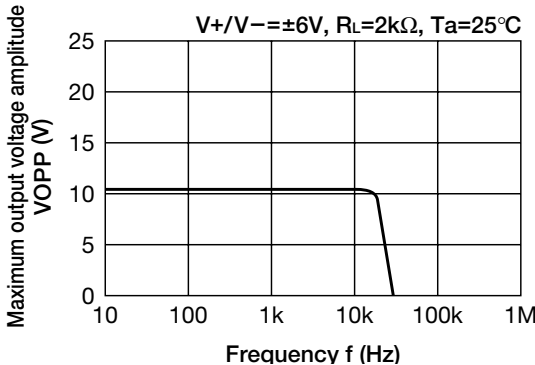

Example of maximum output voltage relative to power supply voltage characteristics

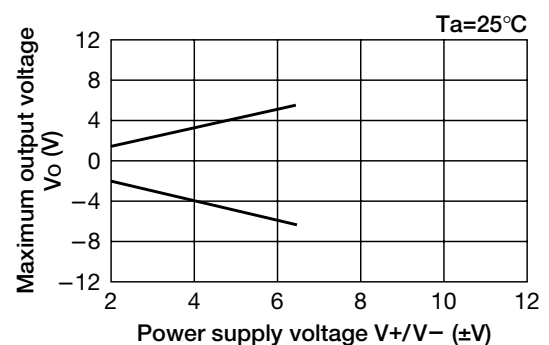

■ Example of voltage gain frequency characteristics

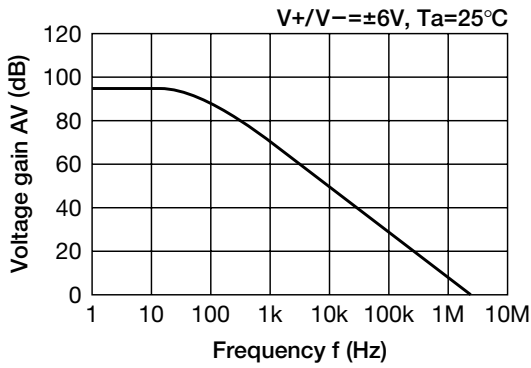

www.DataSheet4U.com

■ MM6565

■ Example of input conversion interference voltage relative to signal source resistance characteristics

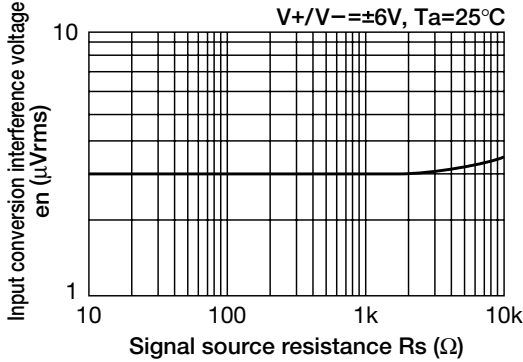

■ Example of current consumption relative to power supply voltage characteristics

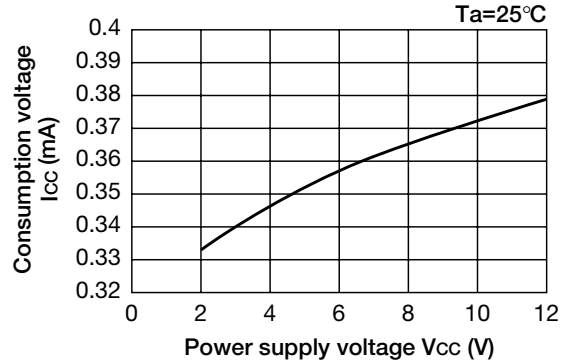

■ Example of input offset voltage relative to power supply voltage characteristics

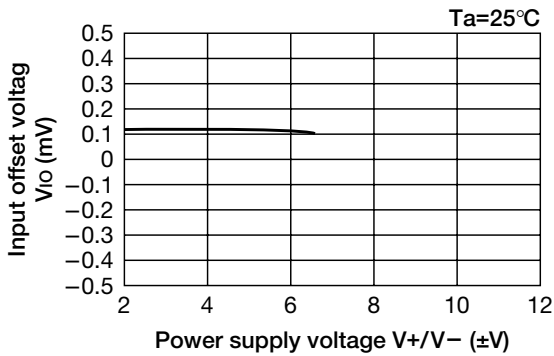

■ Example of complete higher harmonic distortion rate output voltage characteristics

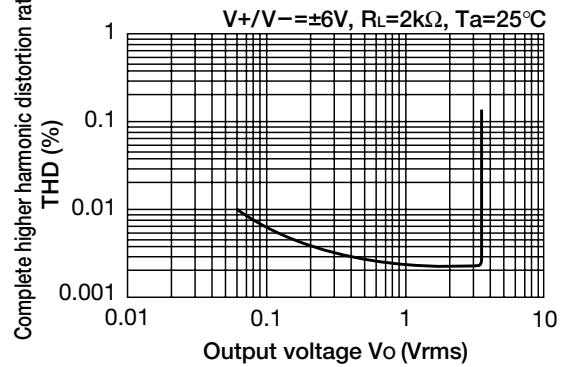

■ Example of input offset current to power supply voltage characteristics

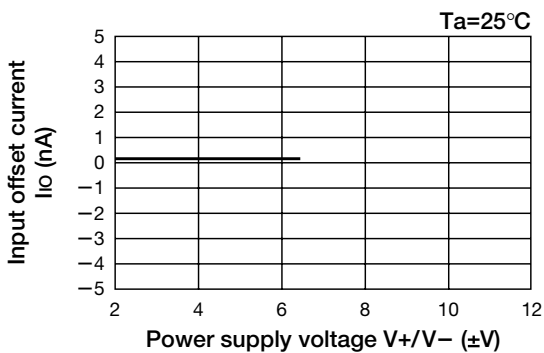

■ Example of power supply voltage elimination frequency characteristics

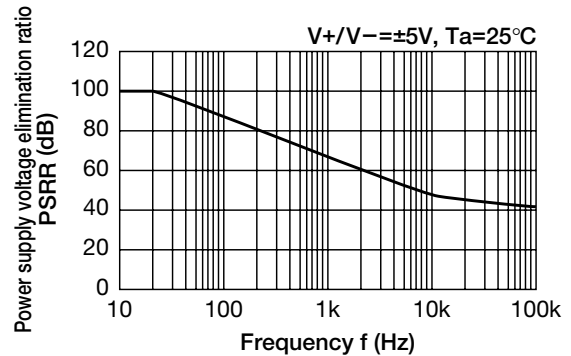

■ Example of maximum output voltage relative to power supply voltage characteristics

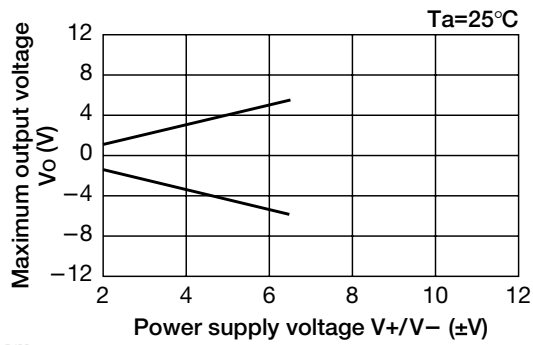

www.DataSheet4U.com

■ Example of maximum output voltage amplitude frequency characteristics

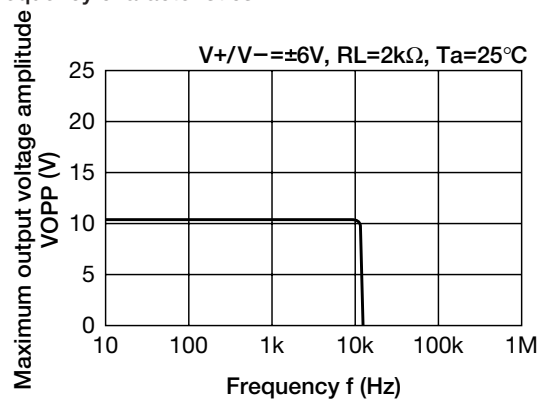

■ Example of maximum output voltage amplitude relative to load characteristics

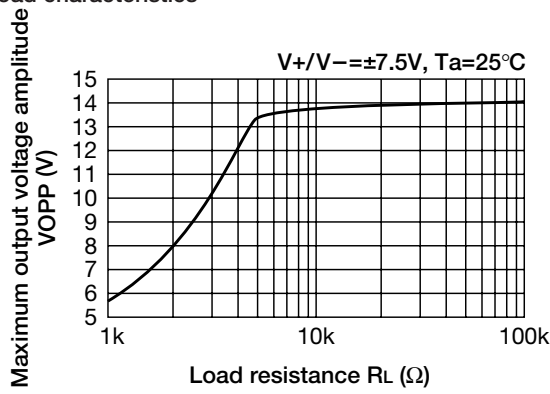

■ Example of voltage gain frequency characteristics

