

## High Power RF LDMOS Field Effect Transistor 8 W, 700 – 2200 MHz

### Description

The PTFA220081M is an unmatched 8-watt LDMOS FET suitable for power amplifiers applications with frequencies from 700 MHz to 2200 MHz. This LDMOS transistor offers excellent gain, efficiency and linearity performance in a small overmolded plastic package.

PTFA220081M  
Package PG-SON-10

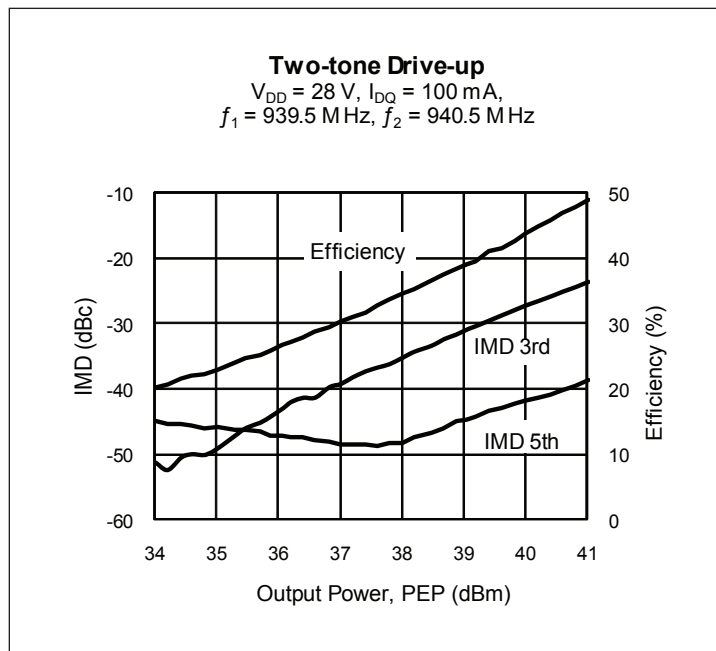

### Features

- Typical two-carrier WCDMA performance, 8 dB PAR
  - $P_{OUT} = 33\text{ dBm Avg}$
  - ACPR = -40 dBc
- Typical CW performance, 940 MHz, 28 V
  - $P_{OUT} = 40\text{ dBm}$
  - Efficiency = 59%
  - Gain = 20 dB
- Typical CW performance, 2140 MHz, 28 V
  - $P_{OUT} = 40\text{ dBm}$
  - Efficiency = 50%
  - Gain = 15 dB
- Capable of handling 10:1 VSWR @ 28 V, 8 W (CW) output power
- Integrated ESD protection : Human Body Model, Class 2 (minimum)
- Excellent thermal stability
- Pb-free and RoHS compliant

### RF Characteristics

**Two-tone Measurements** (not subject to production test – verified by design / characterization in Infineon test fixture)  
 $V_{DD} = 28\text{ V}$ ,  $I_{DQ} = 100\text{ mA}$ ,  $P_{OUT} = 8\text{ W PEP}$ ,  $f = 2140\text{ MHz}$ , tone spacing = 1 MHz

Characteristic	Symbol	Min	Typ	Max	Unit
Gain	$G_{ps}$	—	17	—	dB
Drain Efficiency	$\eta_D$	—	38	—	%
Intermodulation Distortion	IMD	—	-31	—	dBc

All published data at  $T_{CASE} = 25^\circ\text{C}$  unless otherwise indicated

**ESD:** Electrostatic discharge sensitive device—observe handling precautions!

**RF Characteristics** (cont.)

**Two-tone Measurements** (not subject to production test – verified by design / characterization in Infineon test fixture)  
 $V_{DD} = 28\text{ V}$ ,  $I_{DQ} = 100\text{ mA}$ ,  $P_{OUT} = 8\text{ W PEP}$ ,  $f = 940\text{ MHz}$ , tone spacing = 1 MHz

Characteristic	Symbol	Min	Typ	Max	Unit
Gain	$G_{ps}$	–	20.7	–	dB
Drain Efficiency	$\eta_D$	–	39	–	%
Intermodulation Distortion	IMD	–	–30	–	dBc
Input Return Loss	IRL	–	20	–	dB

**DC Characteristics**

Characteristic	Conditions	Symbol	Min	Typ	Max	Unit
Drain-Source Breakdown Voltage	$V_{GS} = 0\text{ V}$ , $I_{DS} = 10\text{ }\mu\text{A}$	$V_{(BR)DSS}$	65	–	–	V
Drain Leakage Current	$V_{DS} = 28\text{ V}$ , $V_{GS} = 0\text{ V}$	$I_{DSS}$	–	–	1.0	$\mu\text{A}$
On-State Resistance	$V_{GS} = 10\text{ V}$ , $V_{DS} = 0.1\text{ A}$	$R_{DS(on)}$	–	1.10	–	$\Omega$
Operating Gate Voltage	$V_{DS} = 28\text{ V}$ , $I_{DQ} = 100\text{ mA}$	$V_{GS}$	2.0	2.5	3.0	V
Gate Leakage Current	$V_{GS} = 10\text{ V}$ , $V_{DS} = 0\text{ V}$	$I_{GSS}$	–	–	1.0	$\mu\text{A}$

**Maximum Ratings**

Parameter	Symbol	Value	Unit
Drain-Source Voltage	$V_{DSS}$	65	V
Gate-Source Voltage	$V_{GS}$	–0.5 to +12	V
Junction Temperature	$T_J$	175	$^{\circ}\text{C}$
Storage Temperature Range	$T_{STG}$	–65 to +150	$^{\circ}\text{C}$
Thermal Resistance (TCASE = 70 $^{\circ}\text{C}$ , 8 W DC )	$R_{\theta JC}$	4.2	$^{\circ}\text{C/W}$

**Moisture Sensitivity Level**

Level	Test Standard	Package Temperature	Unit
3	IPC/JEDEC J-STD-020	260	$^{\circ}\text{C}$

**Ordering Information**

Type	Package Outline	Package Description	Shipping
PTFA220081M V4	PG-SON-10	Molded plastic, SMD	Tape & Reel, 500 pcs

Typical Performance, 940 MHz

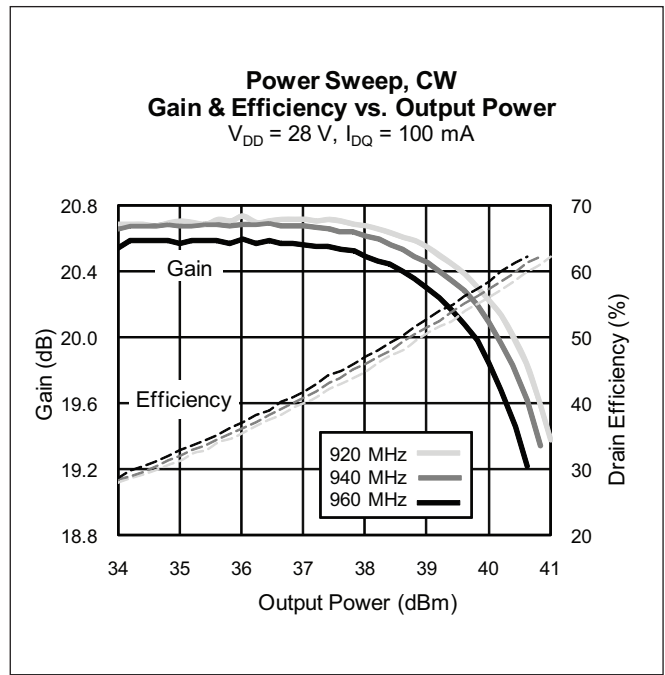
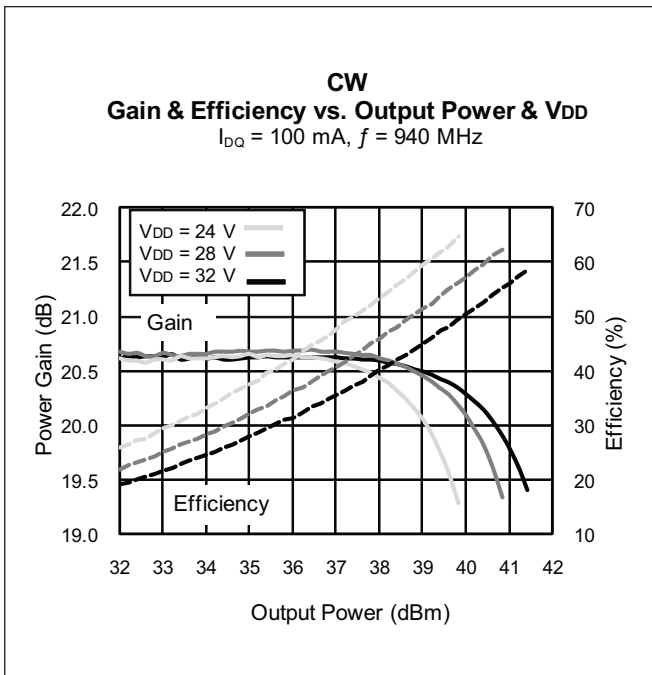
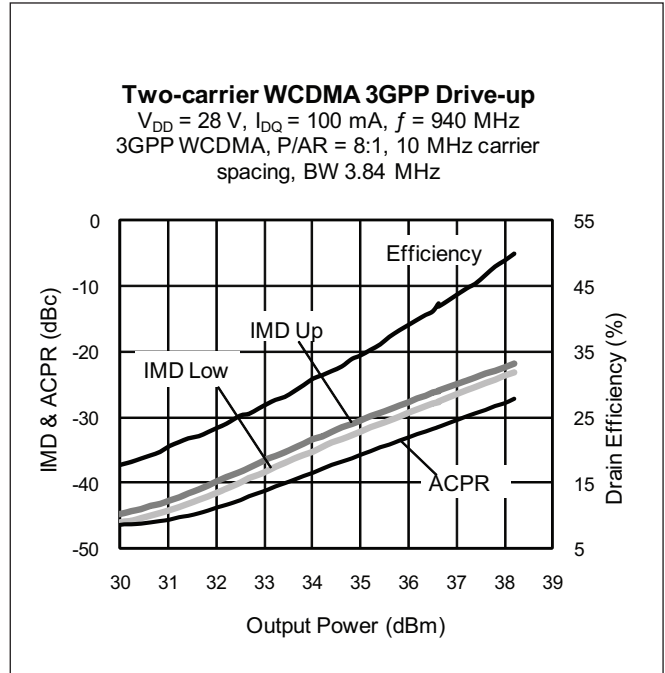
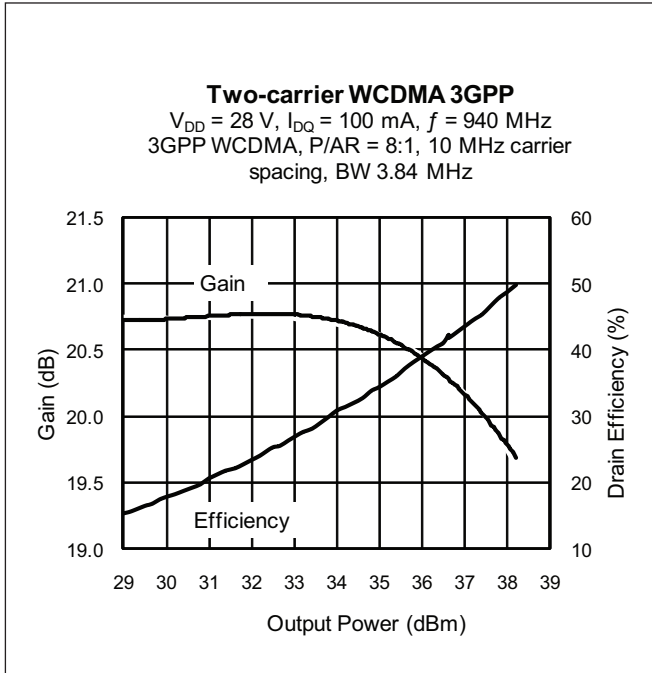

Typical Performance, 940 MHz (cont.)

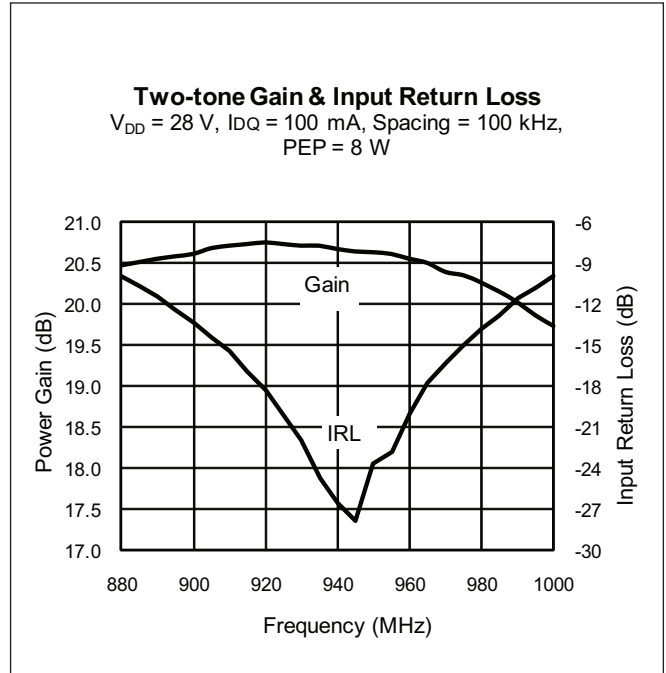
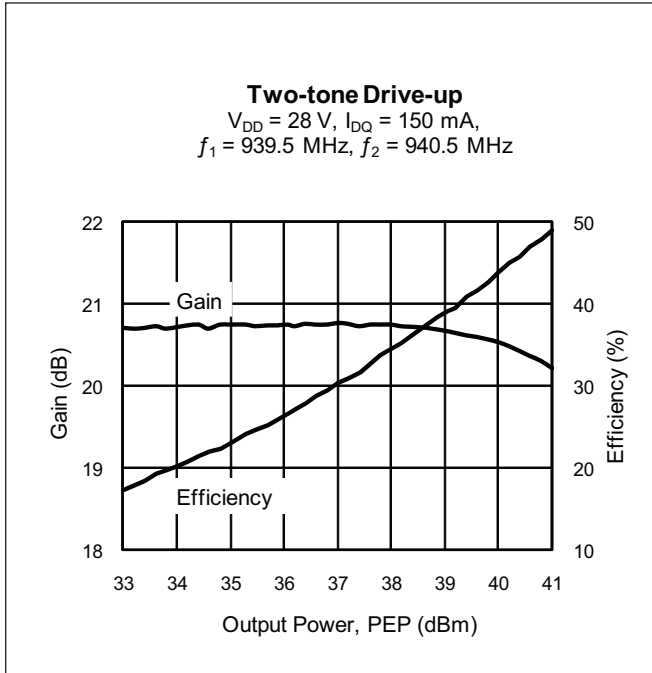

Broadband Circuit Impedance

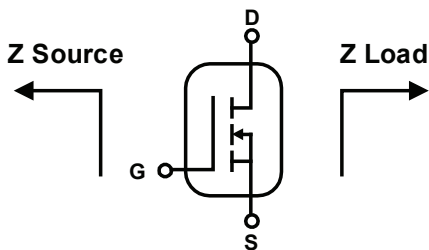

Frequency MHz	Z Source $\Omega$		Z Load $\Omega$	
	R	jX	R	jX
869	1.54	7.20	14.11	9.10
894	1.49	6.60	14.91	8.70
920	1.59	5.70	13.83	9.10
940	1.61	5.10	10.83	10.70
960	1.61	5.10	13.34	9.80
1930	1.91	-2.10	5.59	6.20
1990	2.11	-1.70	4.21	5.20
2110	2.45	-1.00	4.43	5.10
2170	2.30	-1.00	4.25	5.60

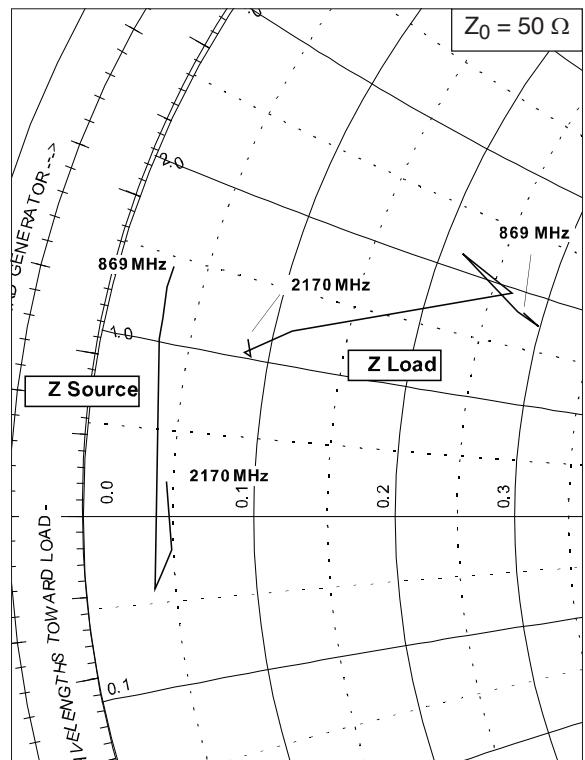



**Reference Circuit, 920 – 960 MHz (cont.)**
**Electrical Characteristics at 960 MHz**

<b>Transmission Line</b>	<b>Electrical Characteristics</b>	<b>Dimensions: mm</b>	<b>Dimensions: mils</b>
<b>Input</b>			
TL101	0.004 $\lambda$ , 51.98 $\Omega$	W1 = 1.087, W2 = 1.087, W3 = 0.813	W1 = 43, W2 = 43, W3 = 32
TL102	0.024 $\lambda$ , 51.98 $\Omega$	W = 1.087, L = 4.445	W = 43, L = 175
TL103	0.011 $\lambda$ , 51.98 $\Omega$	W = 1.087, L = 2.057	W = 43, L = 81
TL104		W = 1.524	W = 60
TL105	0.008 $\lambda$ , 54.17 $\Omega$	W = 1.016, L = 1.524	W = 40, L = 60
TL106	0.027 $\lambda$ , 41.75 $\Omega$	W = 1.524, L = 5.080	W = 60, L = 200
TL107	0.010 $\lambda$ , 25.04 $\Omega$	W = 3.048, L = 1.778	W = 120, L = 70
TL108	0.003 $\lambda$ , 41.75 $\Omega$	W = 1.524, L = 0.508	W = 60, L = 20
TL109	0.007 $\lambda$ , 41.75 $\Omega$	W = 1.524, L = 1.270	W = 60, L = 50
TL110		W1 = 3.048, W2 = 0.762, W3 = 3.048, W4 = 0.762	W1 = 120, W2 = 30, W3 = 120, W4 = 30
TL111, TL112	0.005 $\lambda$ , 51.98 $\Omega$	W1 = 1.087, W2 = 1.087, W3 = 1.016	W1 = 43, W2 = 43, W3 = 40
TL113	0.017 $\lambda$ , 51.98 $\Omega$	W = 1.087, L = 3.264	W = 43, L = 129
TL114	0.070 $\lambda$ , 51.98 $\Omega$	W = 1.087, L = 13.259	W = 43, L = 522
<b>Output</b>			
TL201	0.008 $\lambda$ , 41.75 $\Omega$	W1 = 1.524, W2 = 1.524, W3 = 1.524	W1 = 60, W2 = 60, W3 = 60
TL202, TL225	0.007 $\lambda$ , 47.12 $\Omega$	W1 = 1.270, W2 = 1.270, W3 = 1.270	W1 = 50, W2 = 50, W3 = 50
TL203	0.060 $\lambda$ , 47.12 $\Omega$	W = 1.270, L = 11.361	W = 50, L = 447
TL204		W1 = 0.020, W2 = 0.020, Offset = 0.007	W1 = 20, W2 = 780, Offset = 280
TL205	0.007 $\lambda$ , 4.74 $\Omega$	W = 20.119, L = 1.270	W = 792, L = 50
TL206		W1 = 0.001, W2 = 0.001, Offset = 0.011	W1 = 1, W2 = 50, Offset = 416
TL207	0.003 $\lambda$ , 41.75 $\Omega$	W = 1.524, L = 0.508	W = 60, L = 20
TL208	0.008 $\lambda$ , 41.75 $\Omega$	W = 1.524, L = 1.524	W = 60, L = 60
TL209	0.004 $\lambda$ , 25.04 $\Omega$	W1 = 3.048, W2 = 3.048, W3 = 0.762	W1 = 120, W2 = 120, W3 = 30
TL210		W1 = 1.087, W2 = 3.048	W1 = 43, W2 = 120
TL211	0.010 $\lambda$ , 25.04 $\Omega$	W = 3.048, L = 1.778	W = 120, L = 70
TL212	0.007 $\lambda$ , 63.89 $\Omega$	W = 0.762, L = 1.270	W = 30, L = 50
TL213		W1 = 0.001, W2 = 0.005, Offset = -0.002	W1 = 1, W2 = 208, Offset = -79
TL214	0.044 $\lambda$ , 41.75 $\Omega$	W = 1.524, L = 8.204	W = 60, L = 323
TL215	0.007 $\lambda$ , 41.75 $\Omega$	W1 = 1.524, W2 = 1.524, W3 = 1.270	W1 = 60, W2 = 60, W3 = 50
TL216	0.007 $\lambda$ , 47.12 $\Omega$	W = 1.270, L = 1.267	W = 50, L = 50
TL217	0.032 $\lambda$ , 47.12 $\Omega$	W = 1.270, L = 5.918	W = 50, L = 233
TL218	0.032 $\lambda$ , 15.92 $\Omega$	W = 5.283, L = 5.687	W = 208, L = 224
TL219	0.016 $\lambda$ , 51.98 $\Omega$	W = 1.087, L = 2.946	W = 43, L = 116
TL220	0.017 $\lambda$ , 51.98 $\Omega$	W = 1.087, L = 3.264	W = 43, L = 129
TL221	0.004 $\lambda$ , 51.98 $\Omega$	W1 = 1.087, W2 = 1.087, W3 = 0.813	W1 = 43, W2 = 43, W3 = 32
TL222	0.104 $\lambda$ , 51.98 $\Omega$	W = 1.087, L = 19.736	W = 43, L = 777
TL223	0.011 $\lambda$ , 47.12 $\Omega$	W1 = 1.270, W2 = 1.270, W3 = 2.032	W1 = 50, W2 = 50, W3 = 80
TL224	0.000 $\lambda$ , 144.35 $\Omega$	W1 = 0.025, W2 = 0.025, W3 = 0.025	W1 = 1, W2 = 1, W3 = 1

Reference Circuit, 920 – 960 MHz (cont.)

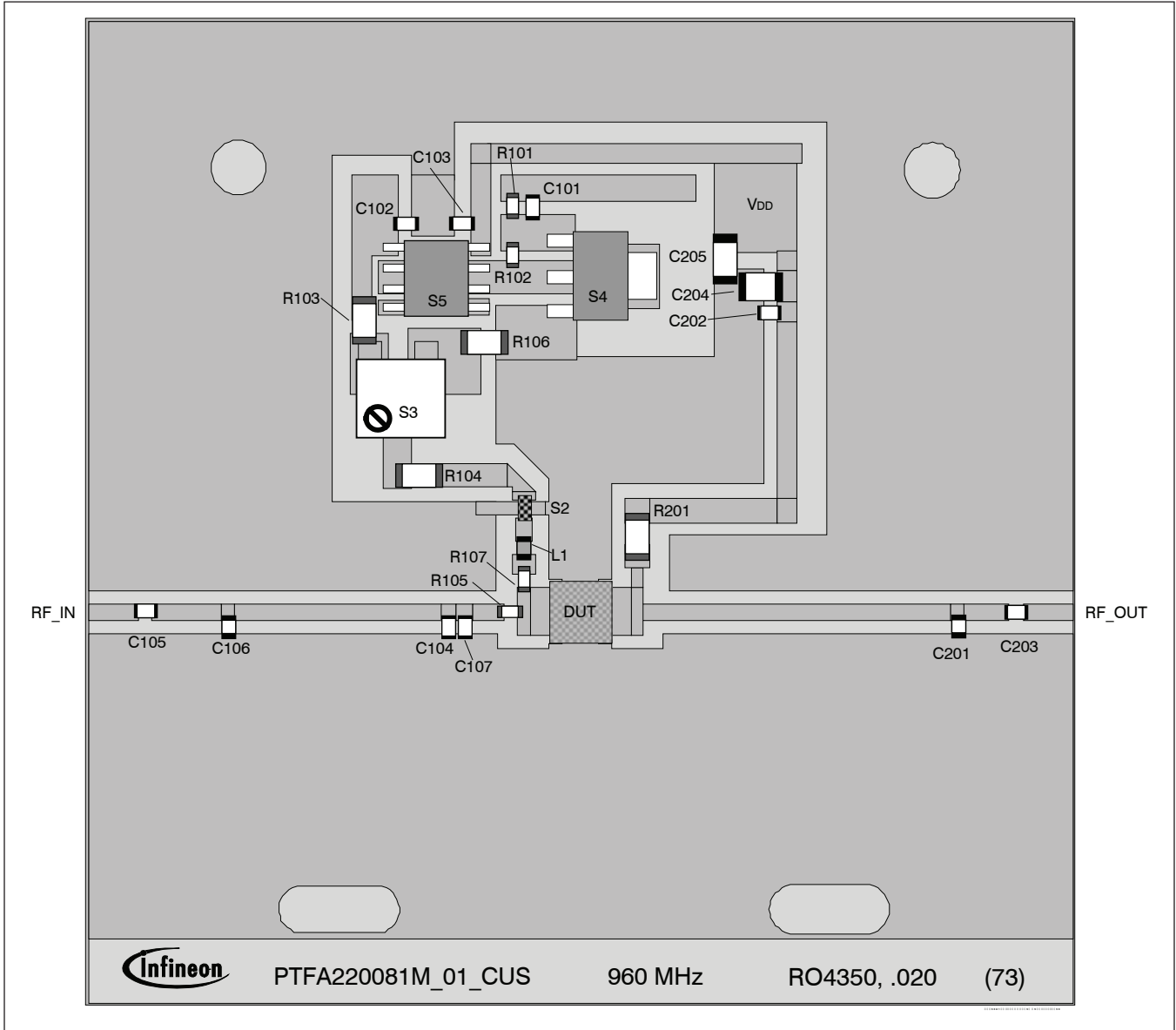

Reference circuit assembly diagram (not to scale)\*

**Reference Circuit, 920 – 960 MHz (cont.)**
**Circuit Assembly Information**

DUT	PTFA220081M	LDMOS Transistor	
PCB	LTN/PTFA220081M-9	0.508 mm [.020"] thick, $\epsilon_r = 3.48$	Rogers 4350, 1 oz. copper

Component	Description	Suggested Manufacturer	P/N
<b>Input</b>			
C101, C102, C103	Chip capacitor, 1000 pF	Digi-Key	PCC1772CT-ND
C104, C107	Chip capacitor, 16 pF	ATC	ATC100A160JW150X
C105	Chip capacitor, 68 pF	ATC	ATC100A680JW150X
C106	Chip capacitor, 5.6 pF	ATC	ATC100A5R6CW150X
L1	Inductor, 22 nH	ATC	ATC0805WL22JT
R101	Resistor, 1300 $\Omega$	Digi-Key	P1.3KGCT-ND
R102	Resistor, 1200 $\Omega$	Digi-Key	P1.2KGCT-ND
R103	Resistor, 2000 $\Omega$	Digi-Key	P2.0KECT-ND
R104	Resistor, 10 $\Omega$	Digi-Key	P10ECT-ND
R105	Resistor, 1.3 $\Omega$	Digi-Key	P1.3GET-ND
R106	Resistor, 510 $\Omega$	Digi-Key	P510ECT-ND
R107	Resistor, 10 $\Omega$	Digi-Key	P10GCT-ND
S2	EMI filter, 2 - 4 A, 0.1 - 2.2 $\mu$ F	Murata	NFM18PS105R0J3
S3	Potentiometer, 2k $\Omega$	Digi-Key	3224W-202ECT-ND
S4	Transistor	Digi-Key	BCP56
S5	Voltage Regulator	National Semiconductor	LM7805
<b>Output</b>			
C201	Chip capacitor, 3.6 pF	ATC	ATC100A3R6CW150X
C202, C203	Chip capacitor, 68 pF	ATC	ATC100A680JW150X
C204	Capacitor, 10 $\mu$ F	Digi-Key	587-1352-1-ND
C205	Chip capacitor, 4.71 $\mu$ F	Digi-Key	PCS3475CT-ND
R201	Resistor, 0 $\Omega$	Digi-Key	P0.0ECT-ND



Typical Performance, 2140 MHz

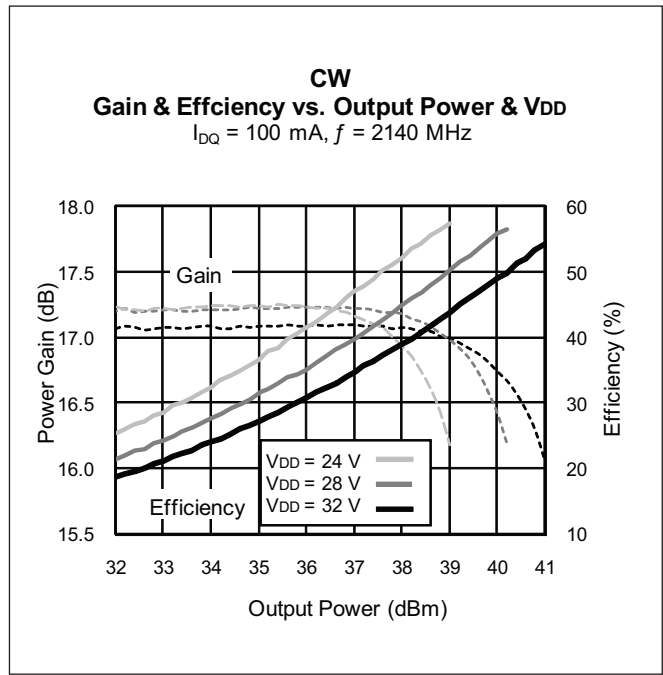
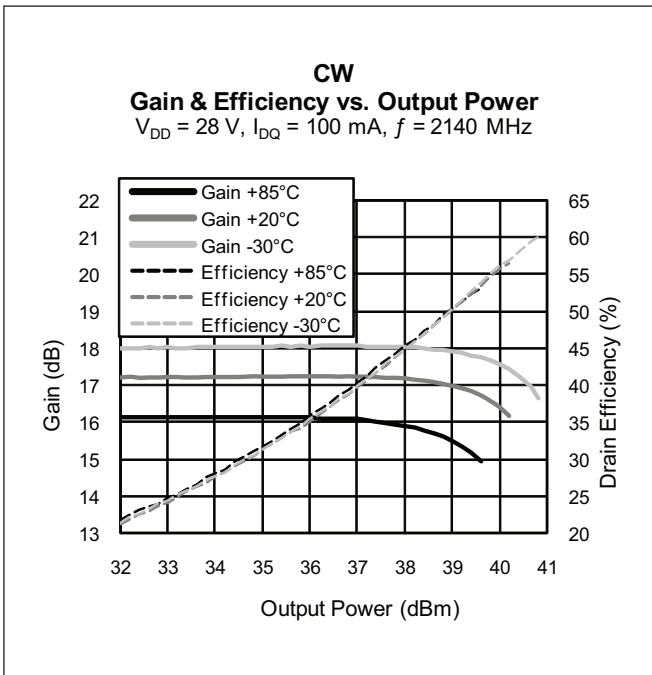
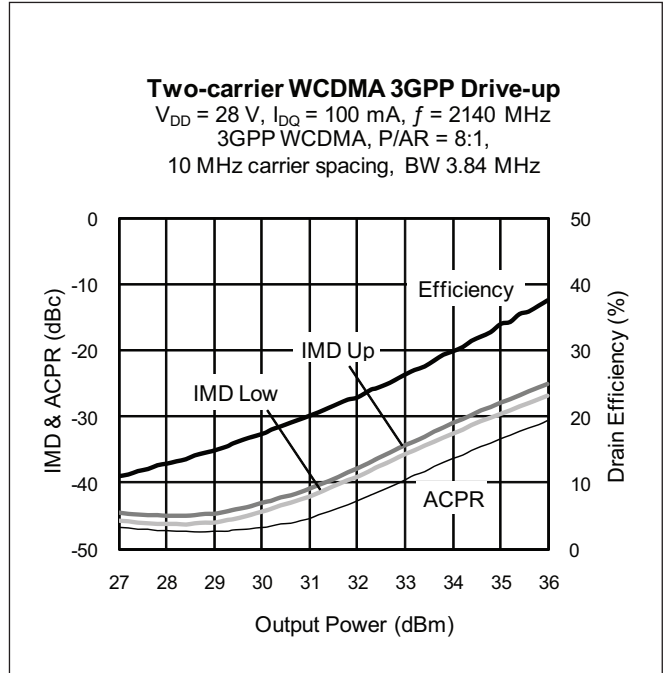
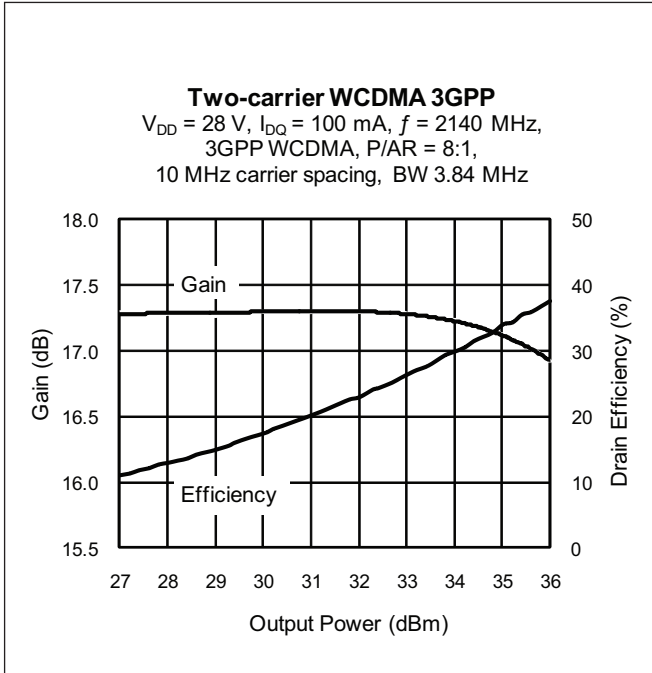

Typical Performance, 2140 MHz (cont.)

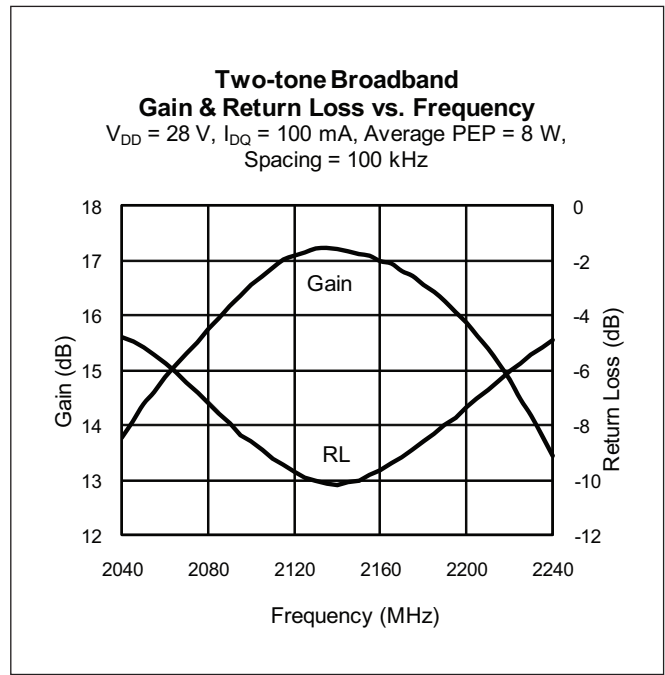
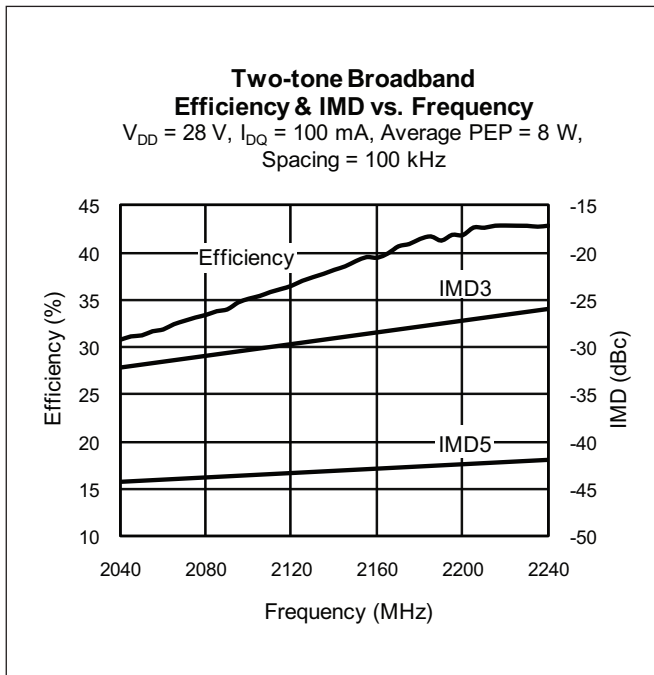
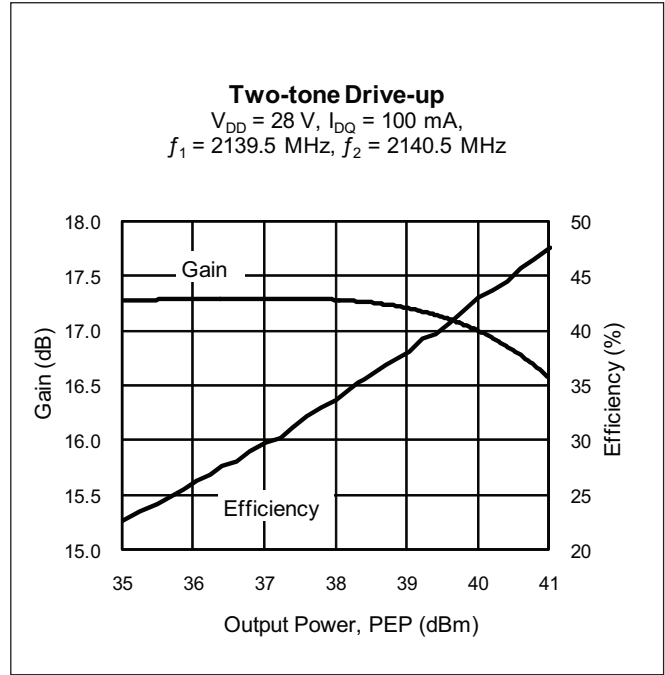
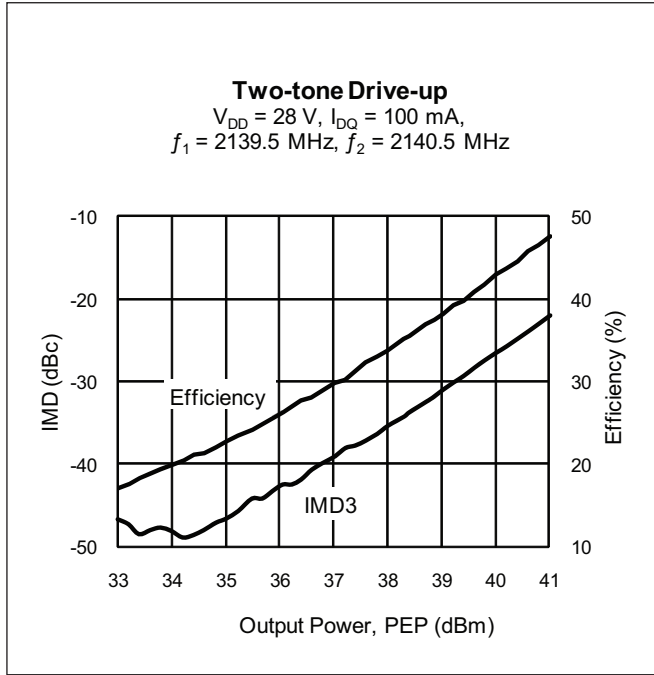

Typical Performance, 2140 MHz (cont.)

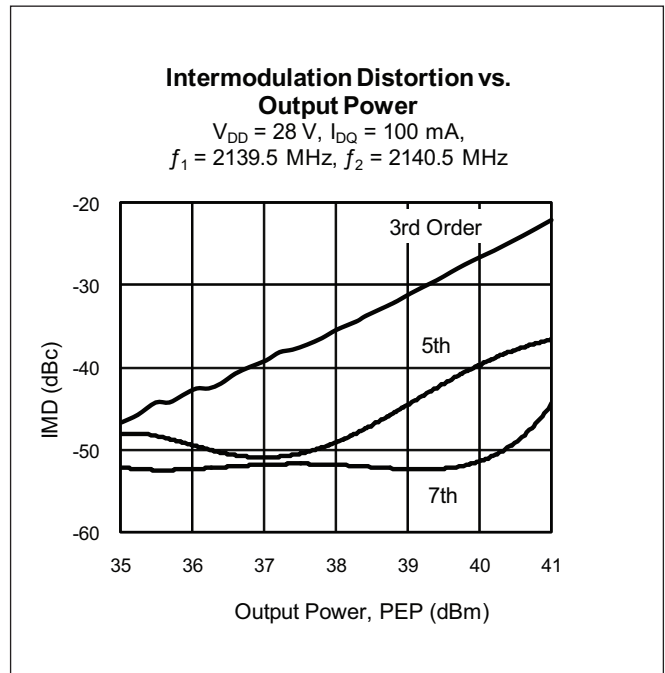
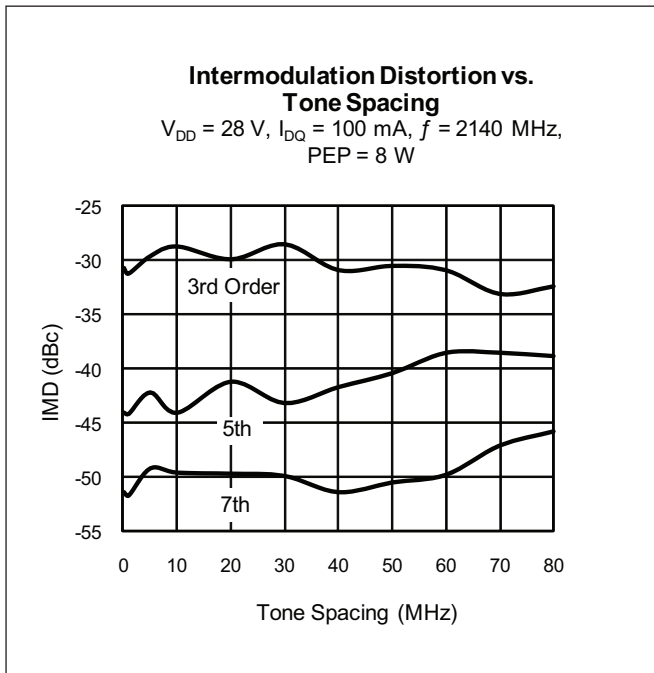
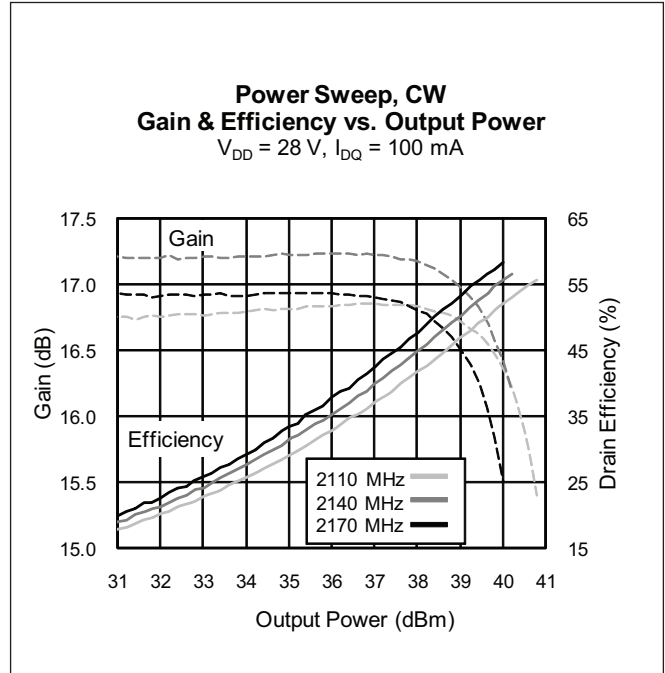
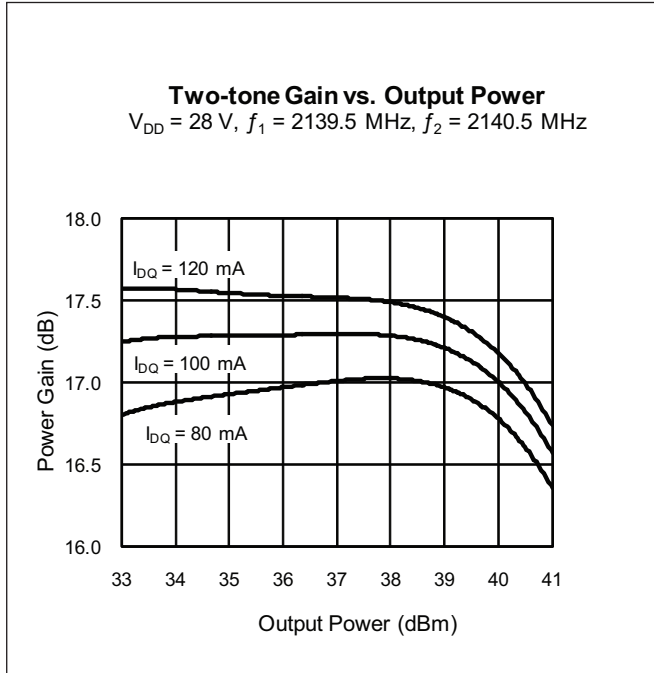

Reference Circuit, 2110 – 2170 MHz

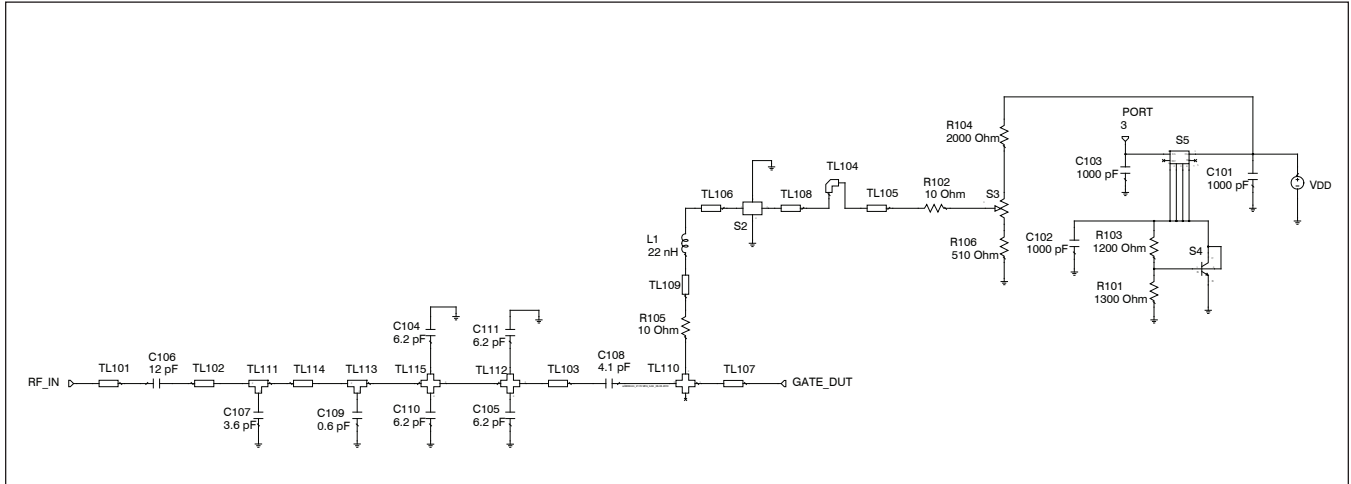

Reference circuit input schematic for  $f = 2110 - 2170$  MHz

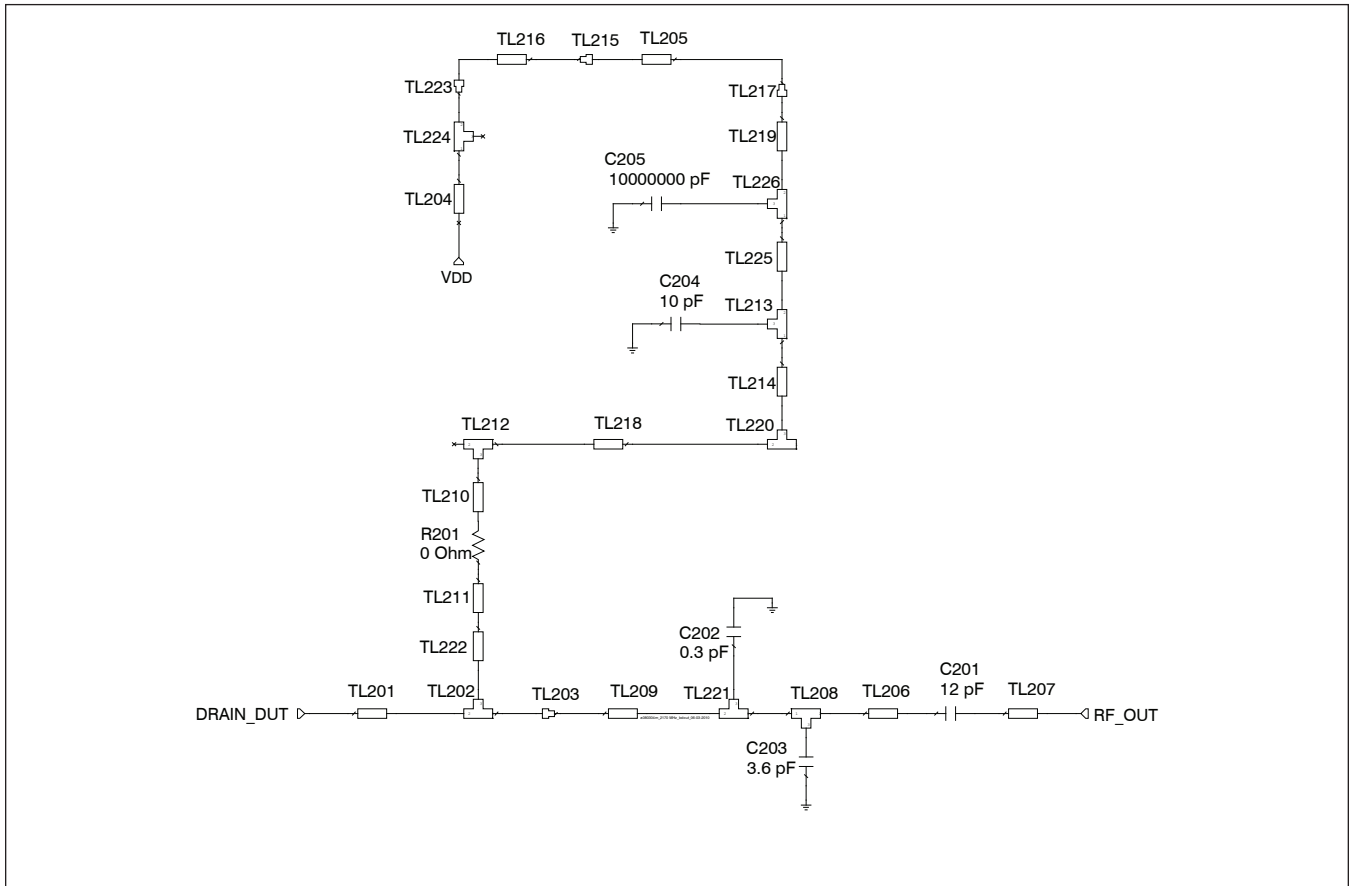

Reference circuit output schematic for  $f = 2110 - 2170$  MHz

**Reference Circuit, 2110 – 2170 MHz (cont.)**
**Electrical Characteristics at 2170 MHz**

<b>Transmission Line</b>	<b>Electrical Characteristics</b>	<b>Dimensions: mm</b>	<b>Dimensions: mils</b>
<b>Input</b>			
TL101	0.054 $\lambda$ , 51.98 $\Omega$	W = 1.087, L = 4.509	W = 43, L = 178
TL102	0.150 $\lambda$ , 51.98 $\Omega$	W = 1.087, L = 12.548	W = 43, L = 494
TL103	0.027 $\lambda$ , 51.98 $\Omega$	W = 1.087, L = 2.261	W = 43, L = 89
TL104		W = 1.524	W = 60
TL105	0.062 $\lambda$ , 41.75 $\Omega$	W = 1.524, L = 5.080	W = 60, L = 200
TL106	0.018 $\lambda$ , 54.17 $\Omega$	W = 1.016, L = 1.524	W = 40, L = 60
TL107	0.022 $\lambda$ , 25.04 $\Omega$	W = 3.048, L = 1.778	W = 120, L = 70
TL108	0.006 $\lambda$ , 41.75 $\Omega$	W = 1.524, L = 0.508	W = 60, L = 20
TL109	0.015 $\lambda$ , 41.75 $\Omega$	W = 1.524, L = 1.270	W = 60, L = 50
TL110		W1 = 3.048, W2 = 0.762, W3 = 3.048, W4 = 0.762	W1 = 120, W2 = 30, W3 = 120, W4 = 30
TL111, TL113	0.012 $\lambda$ , 51.98 $\Omega$	W1 = 1.087, W2 = 1.087, W3 = 1.016	W1 = 43, W2 = 43, W3 = 40
TL112		W1 = 1.087, W2 = 1.016, W3 = 1.087, W4 = 1.016	W1 = 43, W2 = 40, W3 = 43, W4 = 40
TL114	0.028 $\lambda$ , 51.98 $\Omega$	W = 1.087, L = 2.311	W = 43, L = 91
TL115		W1 = 1.087, W2 = 1.016, W3 = 1.087, W4 = 1.016	W1 = 43, W2 = 40, W3 = 43, W4 = 40
<b>Output</b>			
TL201	0.022 $\lambda$ , 25.04 $\Omega$	W = 3.048, L = 1.778	W = 120, L = 70
TL202	0.010 $\lambda$ , 25.04 $\Omega$	W1 = 3.048, W2 = 3.048, W3 = 0.762	W1 = 120, W2 = 120, W3 = 30
TL203		W1 = 1.087, W2 = 3.048	W1 = 43, W2 = 120
TL204	0.071 $\lambda$ , 47.12 $\Omega$	W = 1.270, L = 5.918	W = 50, L = 233
TL205	0.072 $\lambda$ , 15.92 $\Omega$	W = 5.283, L = 5.687	W = 208, L = 224
TL206	0.230 $\lambda$ , 51.98 $\Omega$	W = 1.087, L = 19.202	W = 43, L = 756
TL207	0.039 $\lambda$ , 51.98 $\Omega$	W = 1.087, L = 3.264	W = 43, L = 129
TL208	0.012 $\lambda$ , 51.98 $\Omega$	W1 = 1.087, W2 = 1.087, W3 = 1.016	W1 = 43, W2 = 43, W3 = 40
TL209	0.032 $\lambda$ , 51.98 $\Omega$	W = 1.087, L = 2.642	W = 43, L = 104
TL210	0.006 $\lambda$ , 41.75 $\Omega$	W = 1.524, L = 0.508	W = 60, L = 20
TL211	0.018 $\lambda$ , 41.75 $\Omega$	W = 1.524, L = 1.524	W = 60, L = 60
TL212	0.018 $\lambda$ , 41.75 $\Omega$	W1 = 1.524, W2 = 1.524, W3 = 1.524	W1 = 60, W2 = 60, W3 = 60
TL213	0.015 $\lambda$ , 47.12 $\Omega$	W1 = 1.270, W2 = 1.270, W3 = 1.270	W1 = 50, W2 = 50, W3 = 50
TL214	0.035 $\lambda$ , 47.12 $\Omega$	W = 1.270, L = 2.896	W = 50, L = 114
TL215		W1 = 0.020, W2 = 0.020, Offset = 0.007	W1 = 20, W2 = 780, Offset = 280
TL216	0.017 $\lambda$ , 4.74 $\Omega$	W = 20.119, L = 1.270	W = 792, L = 50
TL217		W1 = 0.001, W2 = 0.005, Offset = -0.002	W1 = 1, W2 = 208, Offset = -79
TL218	0.099 $\lambda$ , 41.75 $\Omega$	W = 1.524, L = 8.204	W = 60, L = 323
TL219	0.015 $\lambda$ , 47.12 $\Omega$	W = 1.270, L = 1.267	W = 50, L = 50
TL220	0.015 $\lambda$ , 41.75 $\Omega$	W1 = 1.524, W2 = 1.524, W3 = 1.270	W1 = 60, W2 = 60, W3 = 50
TL221	0.008 $\lambda$ , 51.98 $\Omega$	W1 = 1.087, W2 = 1.087, W3 = 0.635	W1 = 43, W2 = 43, W3 = 25
TL222	0.015 $\lambda$ , 63.89 $\Omega$	W = 0.762, L = 1.270	W = 30, L = 50
TL223		W1 = 0.001, W2 = 0.001, Offset = 0.011	W1 = 1, W2 = 50, Offset = 416

*Table continued next page*

Reference Circuit, 2110 – 2170 MHz (cont.)

Electrical Characteristics at 2170 MHz (cont.)

Transmission Line	Electrical Characteristics	Dimensions: mm	Dimensions: mils
TL224	0.015 $\lambda$ , 47.12 $\Omega$	W1 = 1.270, W2 = 1.270, W3 = 1.270	W1 = 50, W2 = 50, W3 = 50
TL225	0.111 $\lambda$ , 47.12 $\Omega$	W = 1.270, L = 9.225	W = 50, L = 363
TL226	0.015 $\lambda$ , 47.12 $\Omega$	W1 = 1.270, W2 = 1.270, W3 = 1.270	W1 = 50, W2 = 50, W3 = 50

Reference Circuit, 2110 – 2170 MHz (cont.)

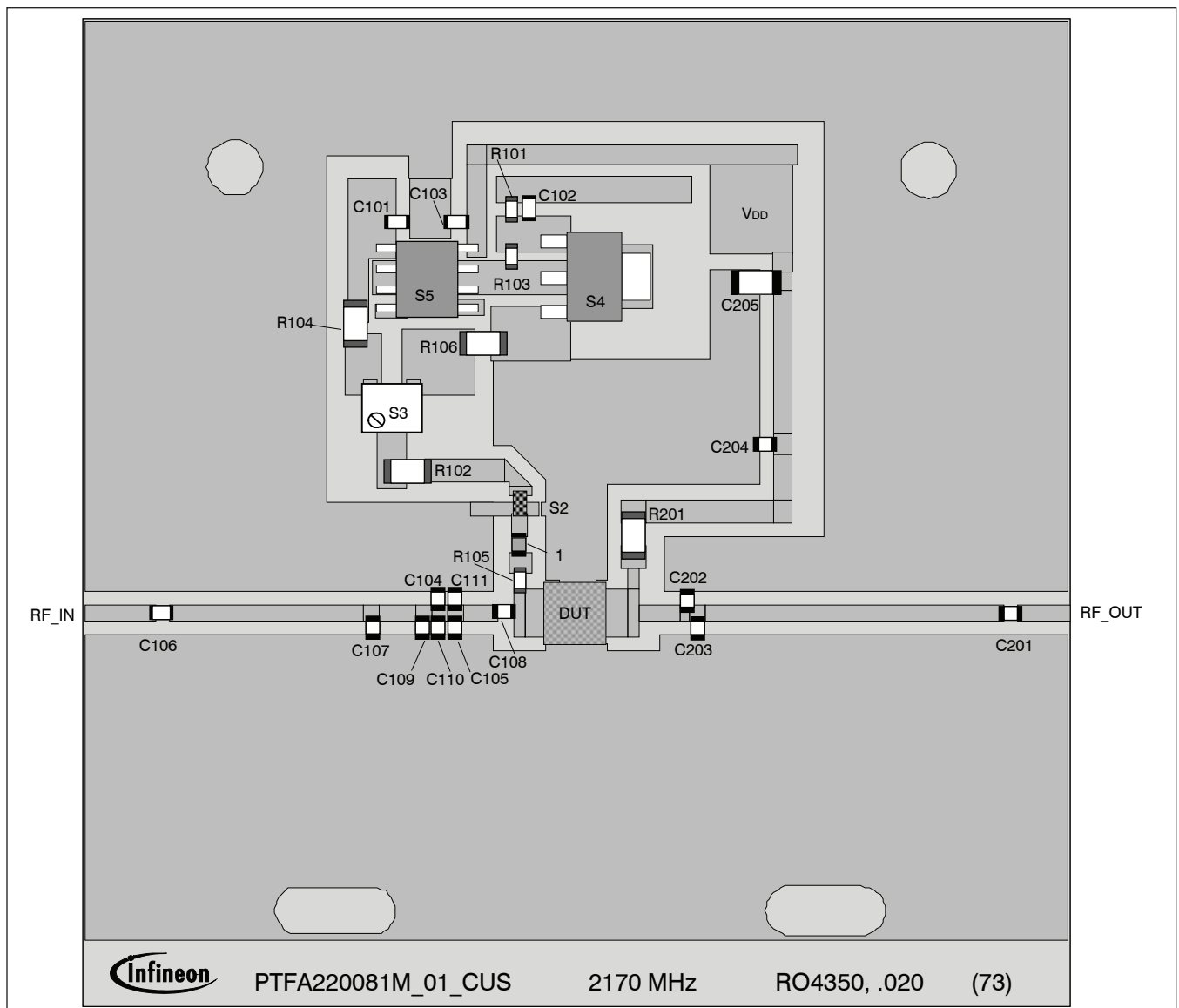

Reference circuit assembly diagram (not to scale)\*

\* Gerber Files for this circuit available on request

**Reference Circuit, 2110 – 2170 MHz (cont.)**
**Circuit Assembly Information**

DUT	PTFA220081M	LDMOS Transistor	
PCB	LTN/PTFA220081M	0.508 mm [.020"] thick, $\epsilon_r = 3.48$	Rogers 4350, 1 oz. copper

Component	Description	Suggested Manufacturer	P/N
<b>Input</b>			
C101, C102, C103	Chip capacitor, 1000 pF	ATC	PCC1772CT-ND
C104, C105, C110, C111	Chip capacitor, 6.2 pF	ATC	ATC100A6R2CW150X
C106	Chip capacitor, 12 pF	ATC	ATC100A120FJW150X
C107	Chip capacitor, 3.6 pF	ATC	ATC100A3R6CW150X
C108	Chip capacitor, 4.1 pF	ATC	ATC100A4R1CW150X
C109	Chip capacitor, 0.6 pF	ATC	ATC100A0R6CW150X
L1	Inductor, 22 nH	ATC	ATC0805WL22JT
R101	Resistor, 1300 $\Omega$	Digi-Key	P1.3KGCT-ND
R102	Resistor, 10 $\Omega$	Digi-Key	P10ECT-ND
R103	Resistor, 1200 $\Omega$	Digi-Key	P1.2KGCT-ND
R104	Resistor, 2000 $\Omega$	Digi-Key	P2.0KECT-ND
R105	Resistor, 10 $\Omega$	Digi-Key	P10GCT-ND
R106	Resistor, 510 $\Omega$	Digi-Key	P510ECT-ND
S2	EMI filter, 2 - 4 A, 0.1 - 2.2 $\mu$ F	Digi-Key	NFM18PS105R0J3
S3	Potentiometer, 2k $\Omega$	Digi-Key	3224W-202ECT-ND
S4	Transistor	Digi-Key	BCP56
S5	Voltage Regulator	National Semiconductor	LM7805

<b>Output</b>			
C201	Chip capacitor, 12 pF	ATC	ATC100A120CW150X
C202	Chip capacitor, 0.3 pF	ATC	ATC100A0R3CW150X
C203	Chip capacitor, 3.6 pF	ATC	ATC100A3R6CW150X
C204	Chip capacitor, 10 pF	ATC	ATC100A100CW150X
C205	Capacitor, 10 $\mu$ F	Digi-Key	587-1352-1-ND
R201	Resistor, 0 $\Omega$	Digi-Key	P0.0ECT-ND

