

1.0 INTRODUCTION

1.1 DESCRIPTION

The WD6022 devices form part of Western Digital's® innovative WD6500 chip set, which facilitates the design and implementation of 32-bit Micro Channel system boards. It decreases design complexity and saves space by combining the functions of many discrete arrays and components, also reducing system cost and increasing system reliability.

The chip set contains two WD6022 devices, one configured as an Address Buffer Device, and the other as a Data Buffer Device. Configuration is determined by a Mode pin. When this is zero, the device is configured as an address buffer; when it is one, the device is configured as a data buffer.

The block diagram in Figure 1 illustrates a typical system using the WD6500 chip set, and shows the two WD6022 devices. Devices with bold outlines are available from Western Digital Corporation.

1.2 FEATURES

- Provides Address and Data Buffers that interface to the Micro Channel
- Meets Micro Channel AC/DC Specifications
- Contains Peripheral Bus Address and Data Buffers
- Low Power 1.25 Micron CMOS Technology
- 132-Lead JEDEC Plastic Quad Flat Pack

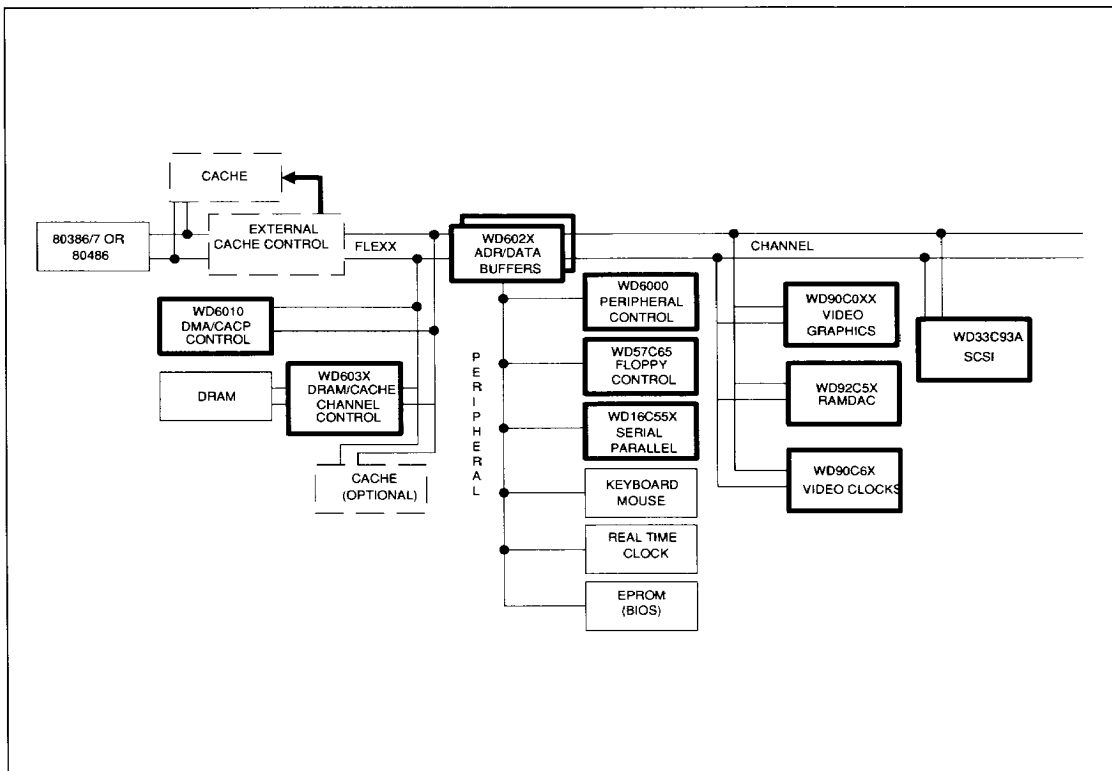

Figure 1. System Block Diagram



2.0 ADDRESS AND DATA BUFFER DEVICES

The WD6500 chip set contains two WD6022 Address and Data Buffer Devices, one configured as an Address Buffer Device, and the second as a Data Buffer Device.

Address Buffer Configuration

To configure the WD6022 as an address buffer, the MODE signal (pin 66) is tied to ground. When configured as an address buffer, the WD6022 performs address bus latches, implements the Central

Translator function for the Micro Channel and provides decodes for the BIOS EPROMs.

Data Buffer Configuration

To configure the WD6022 as a data buffer, the MODE signal is tied to power. In this mode, the WD6022 performs data bus latches, Micro Channel data steering and data swaps for 80386/80486 and DMA operations.



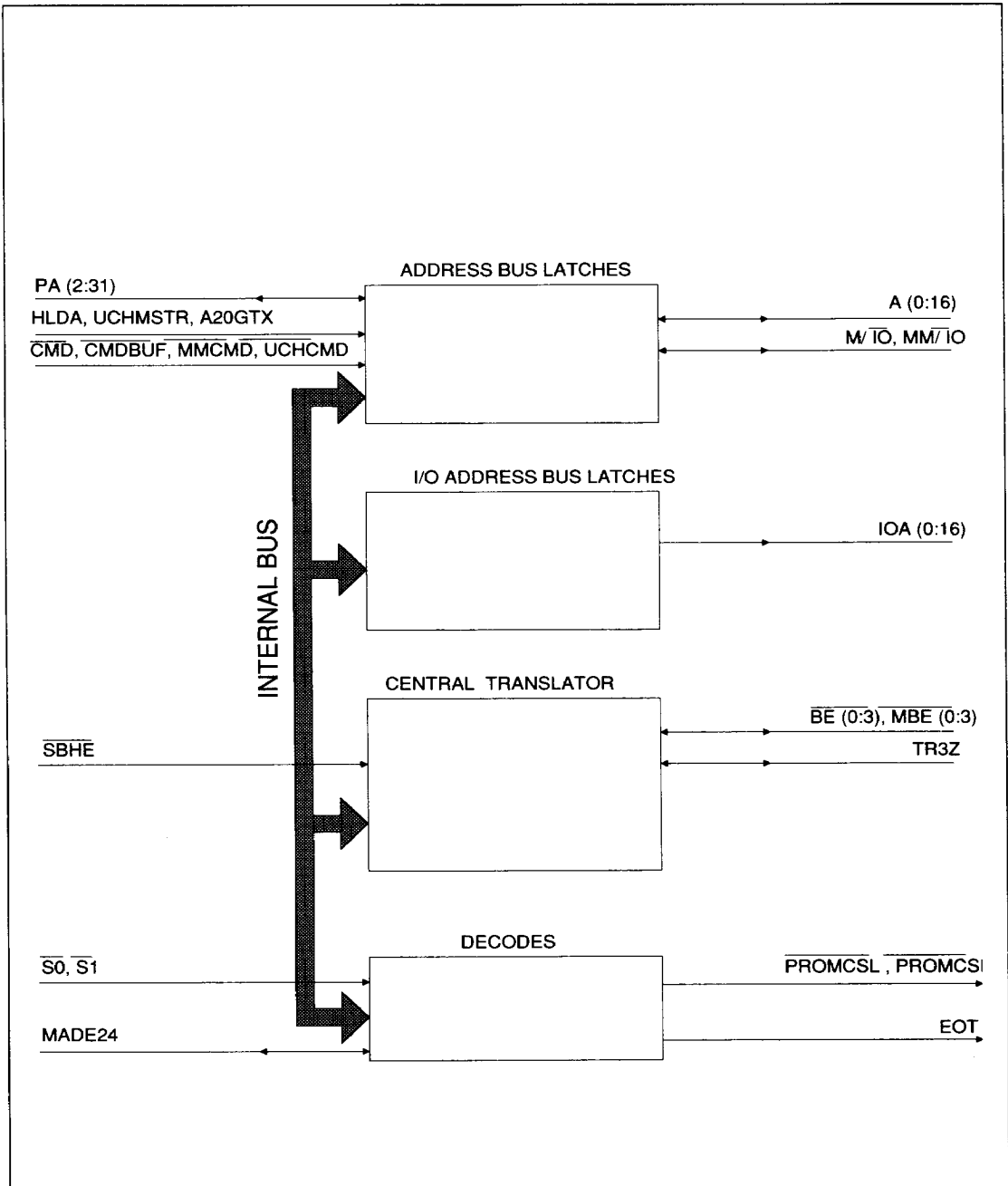

Figure 2. Address Buffer Mode Block Diagram



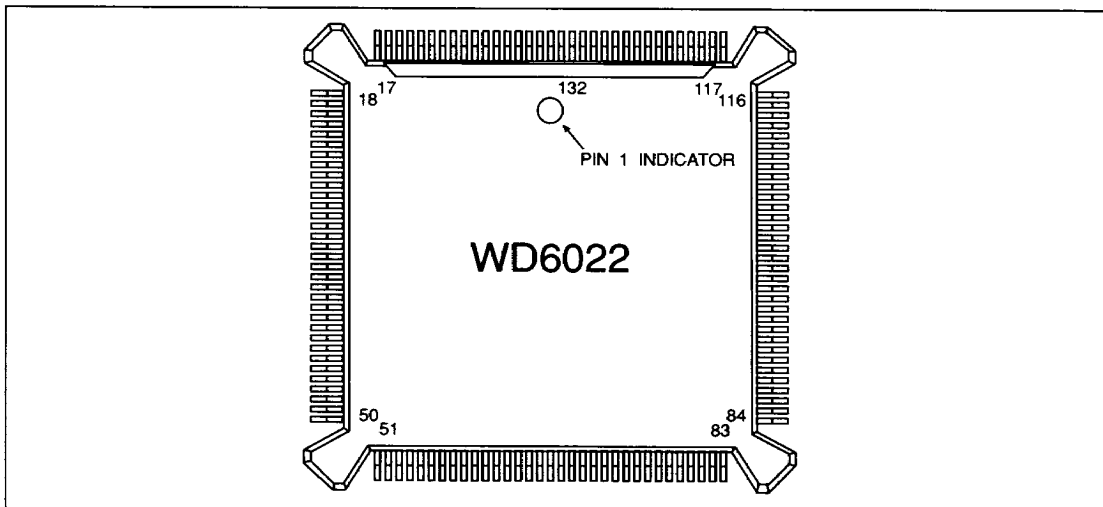

Figure 3. Address Buffer Mode Pin Diagram

PIN	NAME	PIN	NAME	PIN	NAME	PIN	NAME
1	IOA9	34	A9	67	TEST	100	V _{DD}
2	IOA8	35	V _{DD}	68	MM/I _O	101	PA20
3	V _{DD}	36	A10	69	UCHCMD	102	PA19
4	IOA7	37	A11	70	EOT	103	PA18
5	IOA6	38	V _{SS}	71	PROMCSL	104	PA17
6	IOA5	39	A12	72	PROMCSH	105	PA16
7	IOA4	40	A13	73	RESERVED	106	PA15
8	IOA3	41	A14	74	BE2	107	PA14
9	IOA2	42	A15	75	BE3	108	PA13
10	IOA1	43	V _{SS}	76	V _{SS}	109	V _{SS}
11	IOA0	44	A16	77	MBE0	110	PA12
12	MADE24	45	A17	78	MBE1	111	PA11
13	TR32	46	V _{DD}	79	MBE2	112	PA10
14	CMDBUF	47	A18	80	MBE3	113	PA9
15	A20GTX	48	A19	81	M/I _O	114	PA8
16	S1	49	A20	82	BIAS	115	PA7
17	V _{SS}	50	V _{SS}	83	V _{DD}	116	V _{DD}
18	V _{SS}	51	V _{SS}	84	HLDA	117	V _{SS}
19	S0	52	A21	85	MMCMD	118	PA6
20	CMD	53	A22	86	SBHE	119	PA5
21	UCHMSTR	54	A23	87	V _{SS}	120	PA4
22	A0	55	A24	88	PA31	121	PA3
23	A1	56	A25	89	PA30	122	PA2
24	V _{DD}	57	V _{DD}	90	PA29	123	BE1
25	A2	58	A26	91	PA28	124	BE0
26	A3	59	A27	92	PA27	125	IOA16
27	V _{SS}	60	V _{SS}	93	PA26	126	IOA15
28	A4	61	A28	94	PA25	127	IOA14
29	A5	62	A29	95	PA24	128	IOA13
30	A6	63	A30	96	PA23	129	IOA12
31	A7	64	A31	97	PA22	130	IOA11
32	V _{SS}	65	V _{SS}	98	V _{SS}	131	IOA10
33	A8	66	MODE	99	PA21	132	V _{SS}

Table 1. Address Buffer Mode (Mode = 0) Pinout



2.1 ADDRESS BUFFER MODE PIN DESCRIPTIONS

PIN NO.	NAME	TYPE	FUNCTION
ADDRESS BUS LATCHES			
22	A0	I	CHANNEL ADDRESS BUS This Channel address bus interfaces directly to the Channel. It is an input during 80386/DMA cycles. Note that A0 is always an input, and is generated by the WD6030 during 80386/DMA cycles.
23	A1		
25	A2		
26	A3		
28	A4		
29	A5		
30	A6		
31	A7		
33	A8		
34	A9		
36	A10		
37	A11		
39	A12		
40	A13		
41	A14		
42	A15		
44	A16		
45	A17		
47	A18		
48	A19		
49	A20		
52	A21		
53	A22		
54	A23		
55	A34		
56	A25		
58	A26		
59	A27		
61	A28		
62	A29		
63	A30		
64	A31		
124	PA0	I/O	PROCESSOR ADDRESS BUS This is the local processor address bus on the motherboard, and interfaces directly with the processor address bus. It is an input for 80386/80486/DMA cycles and output for master cycles.
123	PA1		
122	PA2		
121	PA3		
120	PA4		
119	PA5		
118	PA6		
115	PA7		
114	PA8		
113	PA9		
112	PA10		
111	PA11		
110	PA12		
108	PA13		
107	PA14		
106	PA15		



PIN NO.	NAME	TYPE	FUNCTION																									
105 104 103 102 101 99 97 96 95 94 93 92 91 90 89 88	PA16 PA17 PA18 PA19 PA20 PA21 PA22 PA23 PA24 PA25 PA26 PA27 PA28 PA29 PA30 PA31	I/O	PROCESSOR ADDRESS BUS (CONT)																									
11 10 9 8 7 6 5 4 2 1 131 130 129 128 127 126 125	IOA0 IOA1 IOA2 IOA3 IOA4 IOA5 IOA6 IOA7 IOA8 IOA9 IOA10 IOA11 IOA12 IOA13 IOA14 IOA15 IOA16	O	I/O ADDRESS BUS This is the I/O address bus on the system board. It is the latched version of the addresses on the Channel. The I/O address bus supplies the addresses to all the Channel peripherals on the system board, such as the video, floppy, serial port, parallel port, timer and interrupt controllers, and EPROM.																									
84	HLDA 80386/ 80486	I	HOLD ACKNOWLEDGE The CPU generates this signal in response to a HOLD signal from the DMA controller. When active, it indicates that the CPU has relinquished control of the local bus.																									
21	UCHMSTR	I	CHANNEL MASTER This signal is generated by the CXACP in the WD6010. When active, it indicates that a Channel master has control of the bus. It is used to control the direction of the address buffers.																									
15	A20GTX	I	ADDRESS BIT 20 GATE SIGNAL This signal is generated by the WD6010, and has no effect on the address when the DMA or Micro Channel master is generating the addresses. It is encoded in the following manner: <table border="1"> <thead> <tr> <th>HLDA</th> <th>UCHMSTR</th> <th>A20GTX</th> <th>A20</th> <th>SOURCE DEVICE</th> </tr> </thead> <tbody> <tr> <td>0</td> <td>0</td> <td>0</td> <td>0</td> <td>80386/80486</td> </tr> <tr> <td>0</td> <td>0</td> <td>1</td> <td>PA20</td> <td>80386/80486</td> </tr> <tr> <td>1</td> <td>0</td> <td>x</td> <td>PA20</td> <td>DMA</td> </tr> <tr> <td>1</td> <td>1</td> <td>x</td> <td>A20</td> <td>Micro Channel Master</td> </tr> </tbody> </table>	HLDA	UCHMSTR	A20GTX	A20	SOURCE DEVICE	0	0	0	0	80386/80486	0	0	1	PA20	80386/80486	1	0	x	PA20	DMA	1	1	x	A20	Micro Channel Master
HLDA	UCHMSTR	A20GTX	A20	SOURCE DEVICE																								
0	0	0	0	80386/80486																								
0	0	1	PA20	80386/80486																								
1	0	x	PA20	DMA																								
1	1	x	A20	Micro Channel Master																								



PIN NO.	NAME	TYPE	FUNCTION
20	<u>CMD</u>	I	COMMAND The Command signal generates the latch signal that latches the Channel addresses when a Channel master has the bus.
14	<u>CMDBUF</u>	I	BUFFERED CHANNEL COMMAND This signal latches the Channel addresses for the IOA (16:0) address bus. The input to this signal is the <u>CMD</u> signal which is generated by the WD6030.
85	<u>MMCMD</u>	I	CHANNEL MATCHED MEMORY COMMAND This is the Matched Memory Command signal on the Channel. This signal is pulled-up as MMC is not supported.
69	<u>UCHCMD</u>	O	CHANNEL COMMAND This signal is the logical OR of the <u>CMD</u> and <u>MMCMD</u> signals, and indicates that a command is present on the Channel. It is used in the WD6010 diagnostic interface.
81	<u>M/IO</u>	I/O	LOCAL BUS M/IO The M/IO signal is on the local bus, and interfaces directly with the M/IO signal on the CPU. When a Channel master accesses the system board DRAM, this signal is a latched version of the MM/IO signal.
68	<u>MM/IO</u>	I/O	CHANNEL M/IO This signal interfaces directly with the Channel M/IO signal, a delayed version of the <u>CMD</u> signal generated by the WD6000. When the 80386 or the DMA accesses the Channel, this signal is the same as M/IO.
CENTRAL TRANSLATOR			
86	<u>SBHE</u>	I	SYSTEM BYTE HIGH ENABLE The System Byte High Enable signal on the Channel interfaces directly to SBHE on the Channel. When the address flow is from the processor bus to the Channel bus, the WD6030 generates this signal as a decode of BE (0:3). When the address flow goes from the Channel bus to the processor bus, this signal is used in the central translator function.
13	<u>TR32</u>	I/O	TRANSLATE 32 The Translate 32 signal on the Channel is used in the central translator logic. When it is active, the central translator translates A0, A1, and SBHE to BE (0:3). TR32 is used for a 16-bit master communicating with a 32-bit slave.
124 123 74 75	<u>BE0</u> <u>BE1</u> <u>BE2</u> <u>BE3</u>	I/O	BYTE ENABLES These byte enables on the local bus interface directly with the 80386/80486 byte enables. When the address flow is from the processor address bus to the Channel address bus, these signals generate Address Bit 1 (A1). A0 is generated by the WD6030. When the address flow is from the Channel address bus to the processor address bus, these signals are generated by a 32-bit master on the Channel or the central translator for a 16-bit master.
77 78 79 80	<u>MBE0</u> <u>MBE1</u> <u>MBE2</u> <u>MBE3</u>	I/O	CHANNEL BYTE ENABLES These Channel byte enable signals interface directly to the BE (0:3) on the Micro Channel. During an 80386/80486/DMA cycle, these signals are outputs. For a master cycle they are not input signals.
DECODES			
19 16	<u>S0</u> <u>S1</u>	I	CHANNEL CONTROL SIGNALS These two signals interface directly to the Channel <u>S</u> (0:1) signals. Together with MADE24, MM/IO, and the Channel address, it generates the PROM chip selects.



PIN NO.	NAME	TYPE	FUNCTION						
12	MADE24	I/O	<p>CHANNEL MADE24 SIGNAL This signal directly interfaces with the Channel MADE24 signal. In combination with S(0:1) and MM/IO, it generates the PROM chip selects. During 80386/80486/DMA cycles, this signal is an output signal.</p> <table border="1"> <thead> <tr> <th>ADDRESSES</th> <th>MADE24</th> </tr> </thead> <tbody> <tr> <td>0-16 MBytes</td> <td>1</td> </tr> <tr> <td>>16 MBytes</td> <td>0</td> </tr> </tbody> </table>	ADDRESSES	MADE24	0-16 MBytes	1	>16 MBytes	0
ADDRESSES	MADE24								
0-16 MBytes	1								
>16 MBytes	0								
71 72	PROMCSL PROMCSH	O O	<p>PROM CHIP SELECT (Low) PROM CHIP SELECT (High) These signals select the two 64K by 8 (27512) PROMs which together form the 128K of PROM on the system board. The two PROMs are organized into even and odd banks, providing a 16-bit wide interface. PROMCSL selects the even banks and PROMCSH selects the odd banks. Configurations with 8-bit wide, 1 M bit PROMs (27010) are also possible. In such a case, PROM Chip Select is generated by executing a logical OR of PROMCSL and PROMCSH. To get the BIOS to execute faster, the PROM can be mapped to the DRAM and executed from there. The PROMs are located at 000E0000H - 000FFFFFH and at FFFE0000 - FFFFFFFFH. An access to either of these locations generates the chip selects for the PROM. However, a Channel cycle to access the PROM will only be run if an access is made to FFFE0000 - FFFFFFFFH, or if a read access is made to E0000 -FFFFF, and the PROM is not mapped to RAM. Writes to these addresses are ignored.</p>						
70	EOT	O	<p>END-OF-TRANSFER This signal is activated when $\overline{\text{CMD}}$ and $\overline{\text{S}}(1:0)$ are inactive. The CACP controller inside the WD6010 uses this signal and BURST to detect an End-of-Transfer condition.</p>						
MISCELLANEOUS									
66	MODE	I	<p>MODE PIN This pin determines the mode of operation for the WD6022 device. When tied to V_{DD}, it puts the WD6022 into the data buffer mode; when it is tied to ground, it puts it into the address buffer mode</p>						
67	TEST	I	<p>TEST PIN This is an active low pin to facilitate board-level testing. When low, this signal tristates all outputs and bi-directional signal lines so that an ATE tester can drive these signals instead.</p>						
82	BIAS	I	<p>BIAS PIN This pin controls the biasing of the internal buffers, and should be pulled low with a 1.25K $\pm 1\%$ resistor.</p>						
3, 24, 35, 46,57, 83, 100, 116	V_{DD}	I	+5 V Power Supply						
17, 18, 27, 32, 38, 43, 50, 51, 60, 65, 76, 87, 98, 109, 117, 132	V_{SS}	I	0 V Ground						



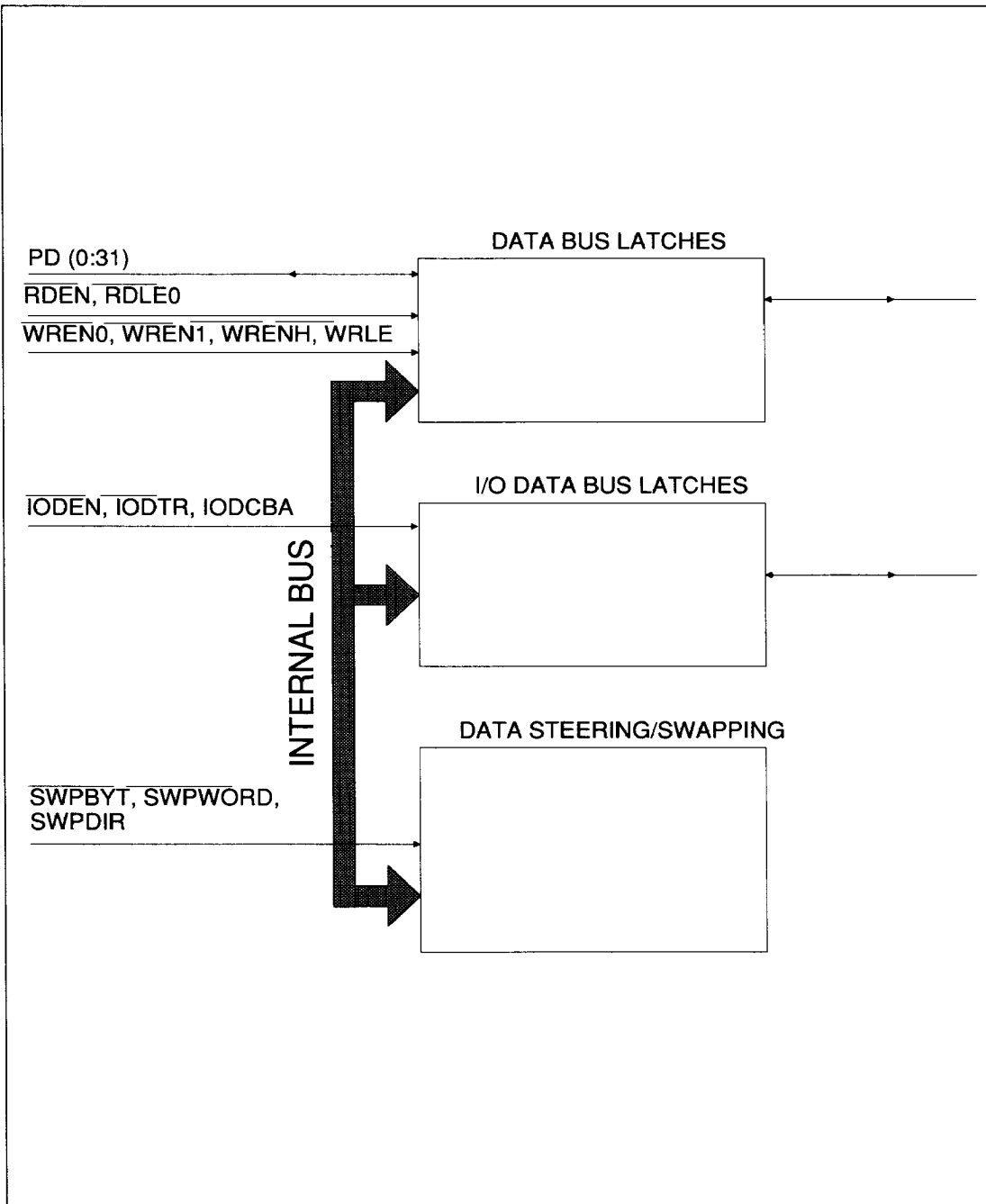

Figure 4. Data Buffer Mode Block Diagram



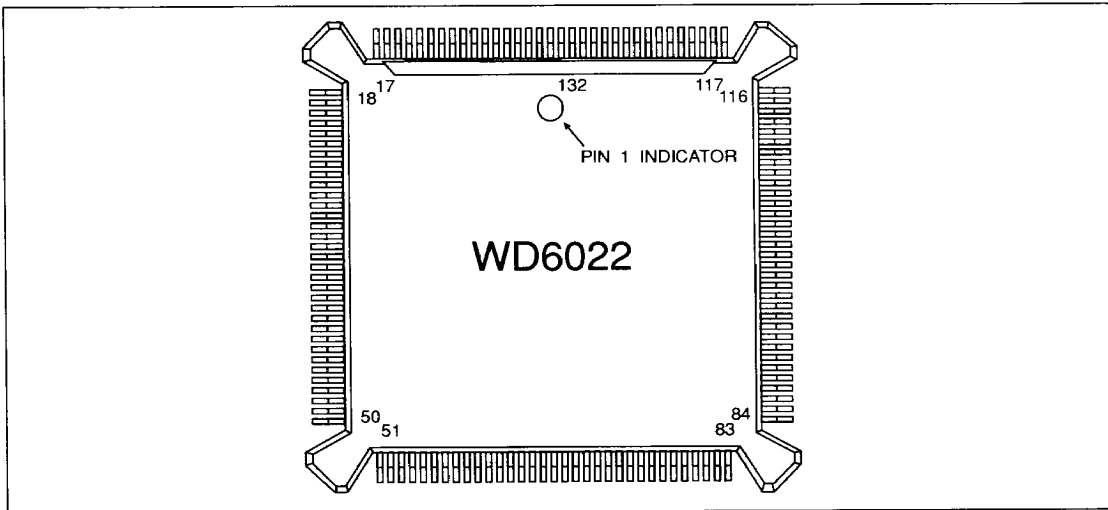

Figure 5. Data Buffer Mode Pin Diagram

PIN	NAME	PIN	NAME	PIN	NAME	PIN	NAME
1	IOD9	34	D9	67	TEST	100	V _{DD}
2	IOD8	35	V _{DD}	68	RESERVED	101	PD20
3	V _{DD}	36	D10	69	RESERVED	102	PD19
4	IOD7	37	D11	70	RESERVED	103	PD18
5	IOD6	38	V _{SS}	71	RESERVED	104	PD17
6	IOD5	39	D12	72	RESERVED	105	PD16
7	IOD4	40	D13	73	RESERVED	106	PD15
8	IOD3	41	D14	74	RESERVED	107	PD14
9	IOD2	42	D15	75	RESERVED	108	PD13
10	IOD1	43	V _{SS}	76	V _{SS}	109	V _{SS}
11	IOD0	44	D16	77	RESERVED	110	PD12
12	IODEN	45	D17	78	RESERVED	111	PD11
13	IODTR	46	V _{DD}	79	RESERVED	112	PD10
14	WRLE	47	D18	80	RESERVED	113	PD9
15	WRENH	48	D19	81	RESERVED	114	PD8
16	WREN1	49	D20	82	BIAS	115	PD7
17	V _{SS}	50	V _{SS}	83	V _{DD}	116	V _{DD}
18	V _{SS}	51	V _{SS}	84	SWPDIR	117	V _{SS}
19	WRENO	52	D21	85	SWPWORD	118	PD6
20	RDLE0	53	D22	86	SWPBYT	119	PD5
21	RDEN	54	D23	87	V _{SS}	120	PD4
22	D0	55	D24	88	PD31	121	PD3
23	D1	56	D25	89	PD30	122	PD2
24	V _{DD}	57	V _{DD}	90	PD29	123	PD1
25	D2	58	D26	91	PD28	124	PD0
26	D3	59	D27	92	PD27	125	IODCBA
27	V _{SS}	60	V _{SS}	93	PD26	126	IOD15
28	D4	61	D28	94	PD25	127	IOD14
29	D5	62	D29	95	PD24	128	IOD13
30	D6	63	D30	96	PD23	129	IOD12
31	D7	64	D31	97	PD22	130	IOD11
32	V _{SS}	65	V _{SS}	98	V _{SS}	131	IOD10
33	D8	66	MODE	99	PD21	132	V _{SS}

Table 2. Data Buffer Mode (Mode = 1) Pinout



2.2 DATA BUFFER MODE PIN DESCRIPTIONS

PIN NO.	NAME	TYPE	FUNCTION
DATA BUS LATCHES			
22	D0	I/O	CHANNEL DATA BUS These Channel data bus signal lines connect directly to the Channel data bus.
23	D1		
25	D2		
26	D3		
28	D4		
29	D5		
30	D6		
31	D7		
33	D8		
34	D9		
36	D10		
37	D11		
39	D12		
40	D13		
41	D14		
42	D15		
44	D16		
45	D17		
47	D18		
48	D19		
49	D20		
52	D21		
53	D22		
54	D23		
55	D24		
56	D25		
58	D26		
59	D27		
61	D28		
62	D29		
63	D30		
64	D31		
124	PD0	I/O	PROCESSOR DATA BUS These processor data bus signal lines connect directly to the 80386 data bus.
123	PD1		
122	PD2		
121	PD3		
120	PD4		
119	PD5		
118	PD6		
115	PD7		
114	PD8		
113	PD9		
112	PD10		
111	PD11		
110	PD12		
108	PD13		
107	PD14		
106	PD15		



PIN NO.	NAME	TYPE	FUNCTION						
105 104 103 102 101 99 97 96 95 94 93 92 91 90 89 88	PD16 PD17 PD18 PD19 PD20 PD21 PD22 PD23 PD24 PD25 PD26 PD27 PD28 PD29 PD30 PD31	I/O	PROCESSOR DATA BUS (CONT)						
11, 9-4, 3-1, 13-125	IOD (0:15) to IOD (0:0)	I/O	16-BIT I/O DATA BUS This is the 16-bit I/O data bus, which provides support for devices eight bits or sixteen bits wide.						
21	$\overline{\text{RDEN}}$	I	READ ENABLE This read-enable signal enables for the processor data bus (PD (0:31)) when data flows from the Channel data bus to the processor data bus. This signal is active when the CPU or the DMA performs a read from the Channel, or when a Channel master writes to the system board DRAM.						
20	$\overline{\text{RDLE0}}$	I	READ LATCH ENABLE 0 This signal is the latch enable signal for Byte 0 (0:7). When the CPU or the DMA performs a cycle to an 8-bit device on the Channel, the cycle is split in two. This signal latches the first 8 bits (0:7) during the first cycle, reads the next 8 bits (8:15) during the second cycle, and this presents the 16 bits to the CPU.						
19 16 15	$\overline{\text{WREN0}}$ $\overline{\text{WREN1}}$ $\overline{\text{WRENH}}$	I	WRITE ENABLE (HIGH, 0:1) This signal enables the buffer during data flow from the processor data bus to the Channel data bus D (0:31). These signals control Byte 0 (0:7) ($\overline{\text{WREN0}}$), byte 1 (8:15) ($\overline{\text{WREN1}}$), and the upper word (16:31) ($\overline{\text{WRENH}}$). These signals are valid when the CPU or the DMA performs a write operation to the Channel or when a Channel master performs a read from the motherboard DRAM.						
14	$\overline{\text{WRLE}}$	I	WRITE LATCH ENABLE This write latch enable signal latches the write data during a CPU or DMA write operation to the Channel. It also provides the write-data-hold time required by the Channel during these operations. This signal also latches the data when the CPU or DMA writes to an 8-bit port and the cycle has to be split in two.						
12	$\overline{\text{IODEN}}$	I	I/O DATA ENABLE The I/O Data Enable signal enables the I/O data buffers and is generated by the WD6000. When it is active, the WD6022 drives either D(0:15) or IOD(0:15), depending on the direction set by the IODTR signal.						
13	$\overline{\text{IODTR}}$	I	I/O DATA TRANSMIT/RECEIVE The I/O Data Transmit/Receive signal controls the direction of the I/O data buffers inside the WD6022. The signal itself is generated by the WD6000 device. <table border="0" style="margin-left: 40px;"> <tr> <td>$\overline{\text{IODTR}}$</td> <td>DIRECTION</td> </tr> <tr> <td>1</td> <td>D(0:15) to IOD(0:15)</td> </tr> <tr> <td>0</td> <td>IOD(0:15) to D(0:15)</td> </tr> </table>	$\overline{\text{IODTR}}$	DIRECTION	1	D(0:15) to IOD(0:15)	0	IOD(0:15) to D(0:15)
$\overline{\text{IODTR}}$	DIRECTION								
1	D(0:15) to IOD(0:15)								
0	IOD(0:15) to D(0:15)								



PIN NO.	NAME	TYPE	FUNCTION
125	IODCBA	I	I/O DATA CLOCK The I/O Data Clock signal is used to latch the data during reads from the Channel peripherals on the I/O bus. The MEMRD, MEMWR, IORD, and IOWR commands to the peripherals are shorter than the Channel CMD signal. This signal ensures that the data being read meets the timings of the Channel CMD signal.
DATA STEERING/SWAPPING			
86	SWPBYT	I	BYTE SWAP When the CPU or DMA accesses an 8-bit port the cycle is split into two. This signal is used to swap the data to the correct byte: D(0:7) are swapped to D(8:15) for a read operation; D(8:15) are swapped to D(0:7) for a write operation.
85	SWPWORD		WORD SWAP This signal swaps words when a 16-bit Channel master communicates with a 32-bit slave. The cycle is split into two and SWPWORD is used to swap data to the correct word: D(16:31) is swapped to D(0:15) for a Channel master read operation and D(0:15) is swapped to D(16:31) for a Channel master write operation. This function is known as data steering.
84	SWPDIR (COPRES)	I	SWAP DIRECTION At power-up, the state of this signal is latched by the WD6030 to determine the presence of the numeric coprocessor. At all other times, SWPDIR determines the direction of the byte and word swap buffers. A low on SWPDIR indicates a read operation (byte swap D(0:7) to D(8:15) or a Channel master write operation (word swap D(0:15) to D(16:31))). A high on SWPDIR indicates a write operation (byte swap D(8:15) to D(0:7)).
MISCELLANEOUS			
66	MODE	I	MODE PIN This pin determines the mode of operation for the WD6022 device. When tied to V _{DD} , it puts the WD6022 into the data buffer mode; when it is tied to ground, it puts it into the address buffer mode..
67	TEST	I	TEST PIN This is an active low pin to facilitate board-level testing. When low, this signal tristates all outputs and bi-directional signal lines so that an ATE tester can drive these signals instead.
82	BIAS	I	BIAS PIN This pin controls the biasing of the internal buffers, and should be pulled low with a 1.25K \pm 1% resistor.
3, 24, 35, 46,57, 83, 100, 116	V _{DD}	I	+5 V Power Supply
17, 18, 27, 32, 38, 43, 50, 51, 60, 65, 76, 87, 98, 109, 117, 132	V _{SS}	I	0 V Ground



PIN NO.	NAME	TYPE	FUNCTION
68, 69, 70, 71, 72, 73, 74, 75, 77, 78, 79, 80, 81	Reserved	-	RESERVED PINS These pins should not be connected.



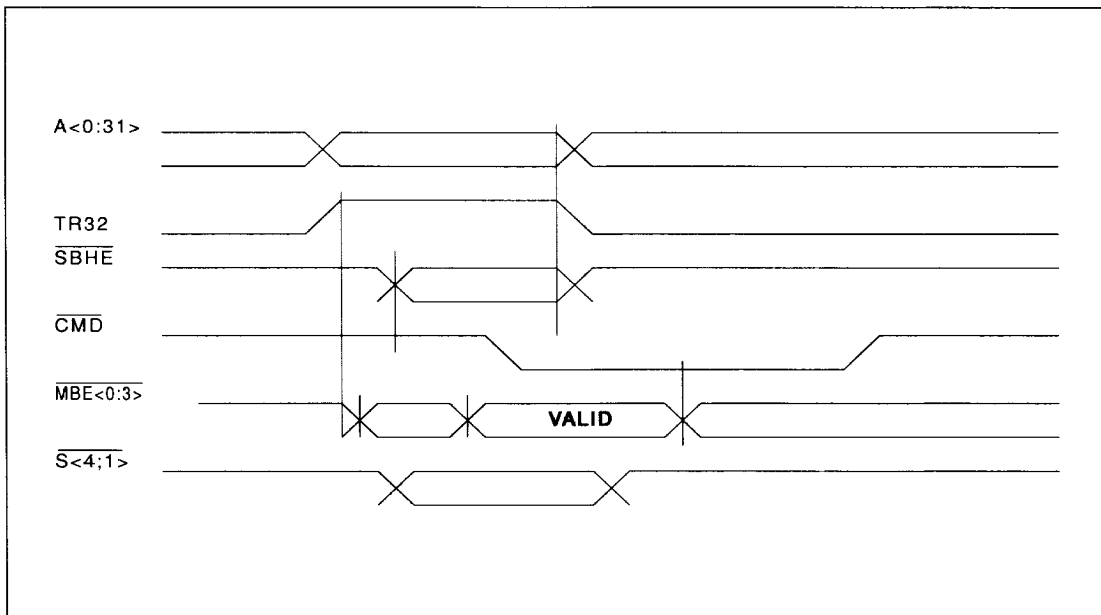

Figure 6. Address Mode: Channel Master Accesses Translate Function

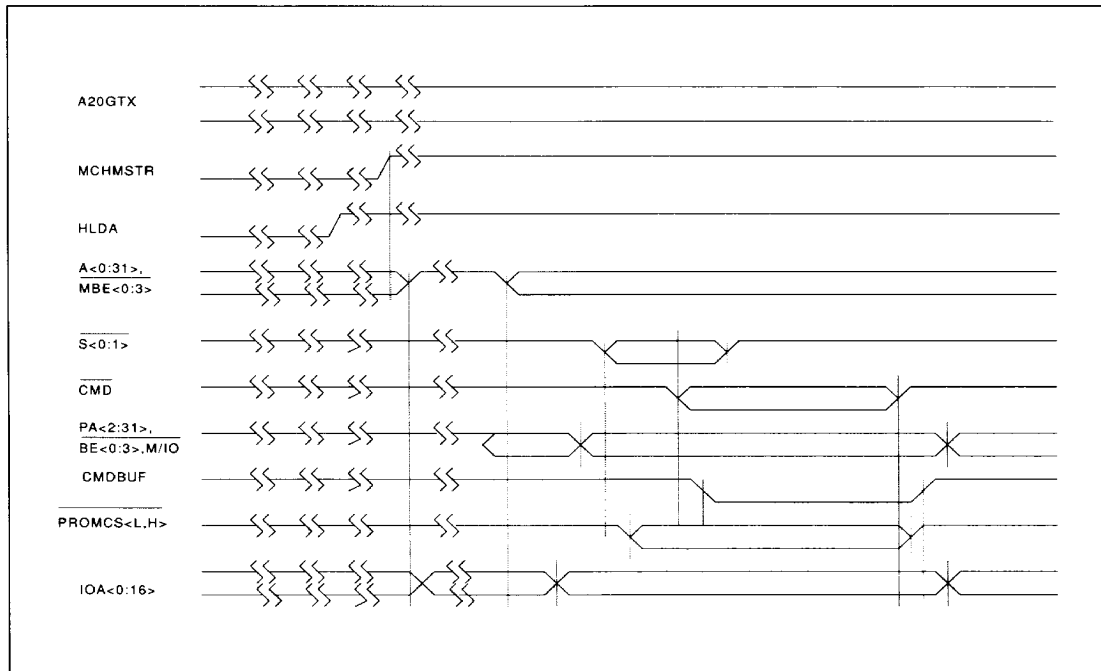

Figure 7. Address Mode: Channel Master Accesses



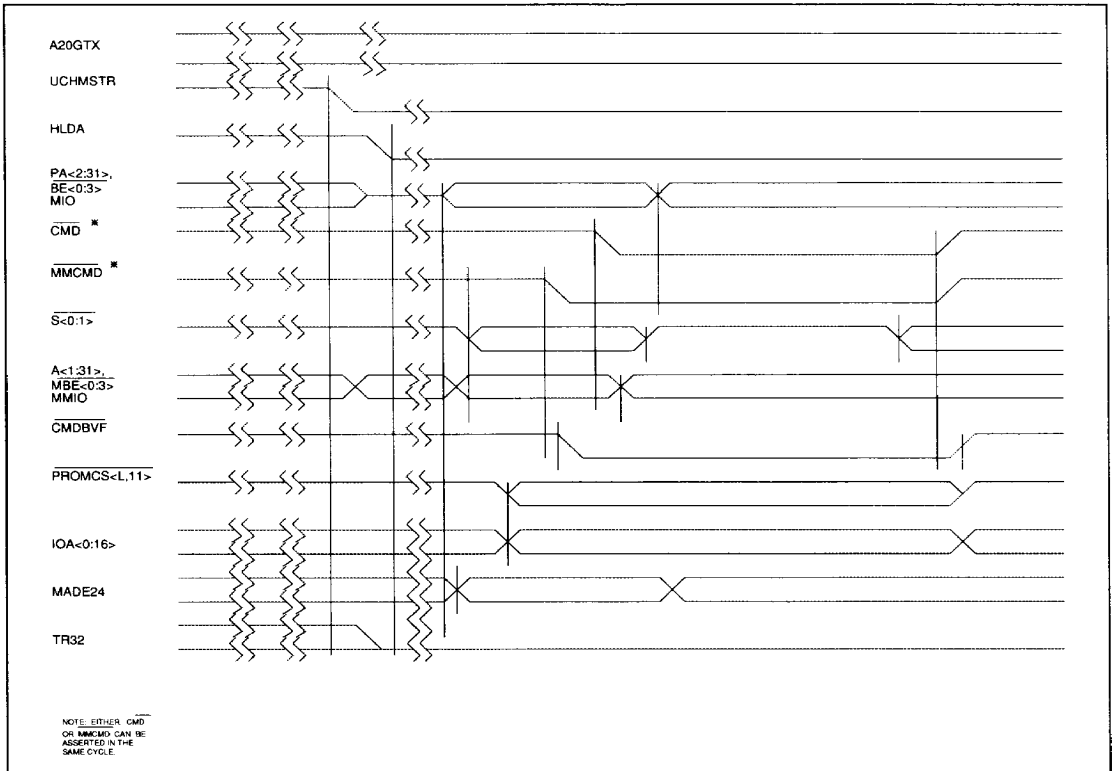

Figure 8. Address Mode: 80386/80486/DMA Channel Accesses

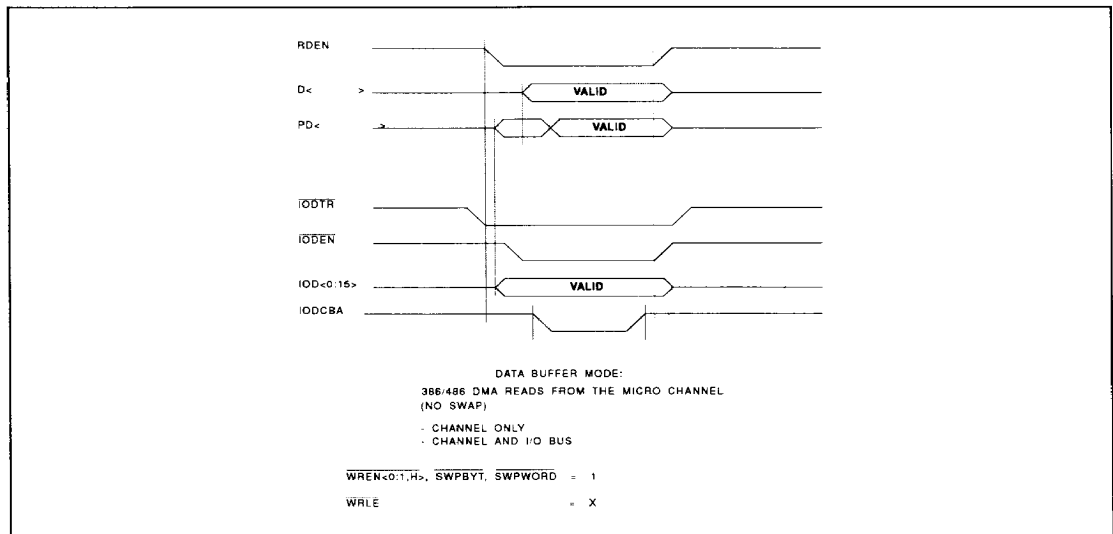

Figure 9. Data Mode: 80386/80486/DMA Reads from the Channel



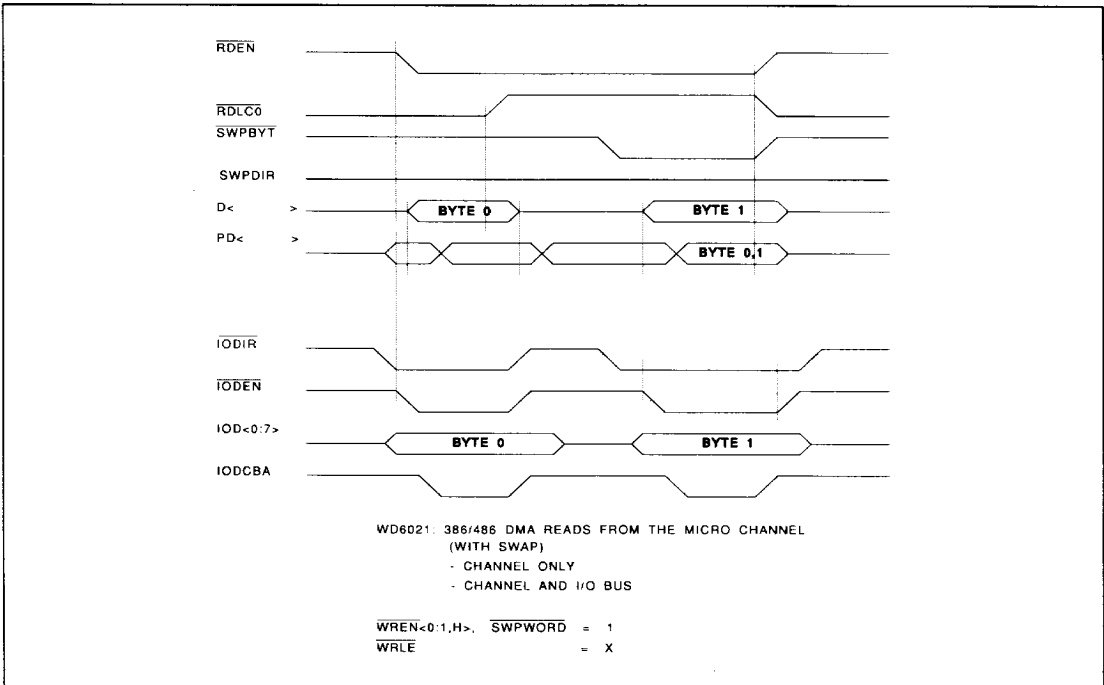

Figure 10. Data Mode: 80386/80486/DMA Reads from the Channel with Swap

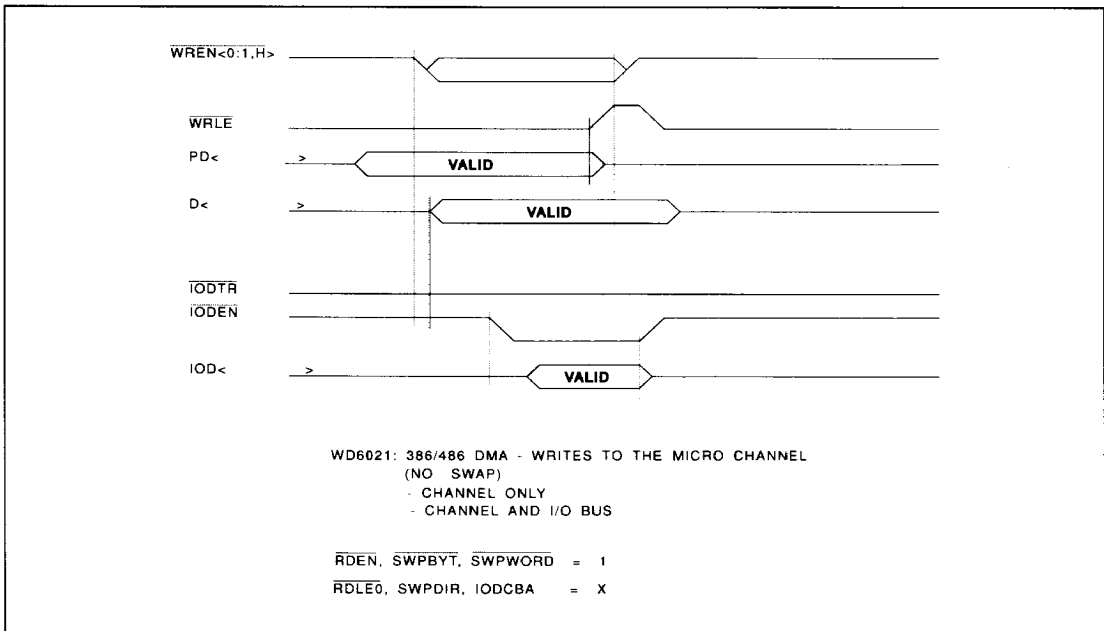

Figure 11. Data Mode: 80386/80486/DMA Writes to the Channel



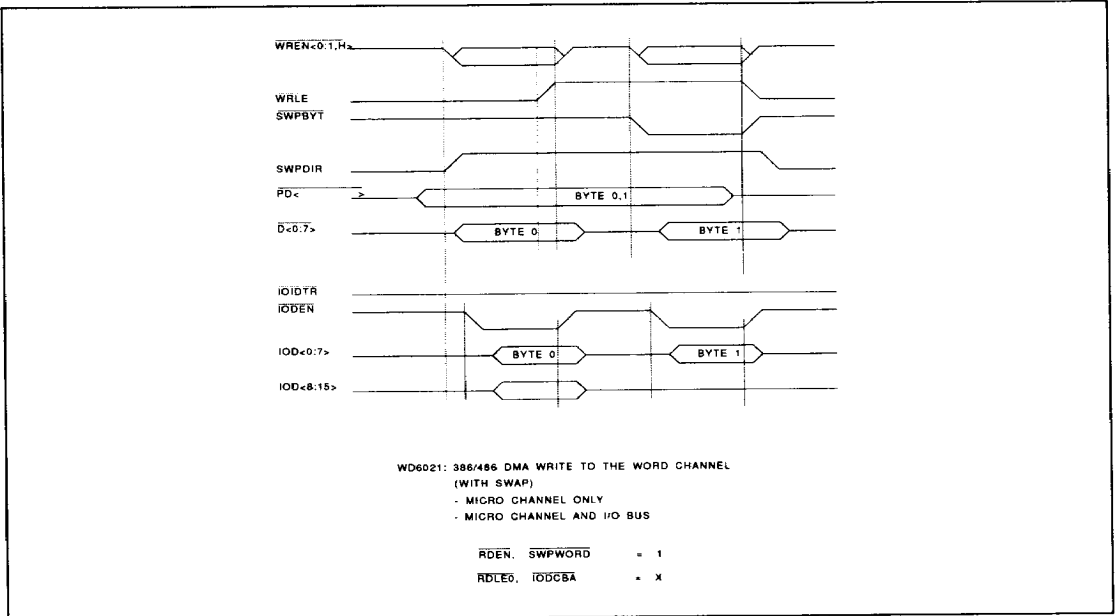

Figure 12. Data Mode: 80386/80486/DMA Writes to the Channel with Swap

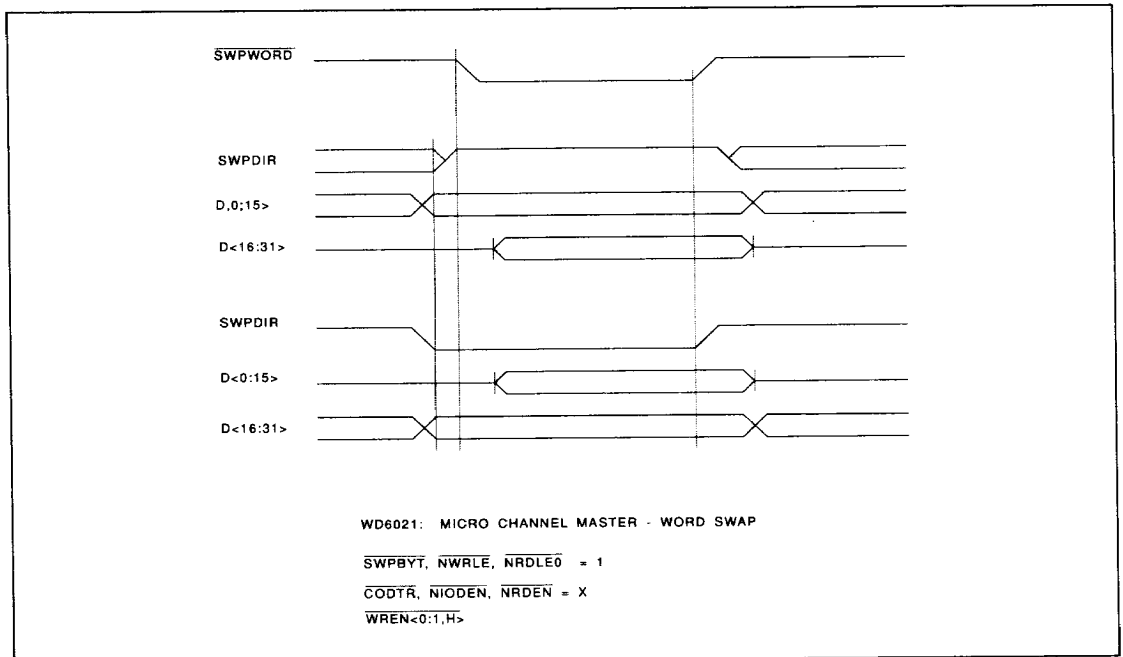

Figure 13. Data Mode: Channel Master Word Swap



3.0 TECHNICAL SPECIFICATIONS

3.1 ABSOLUTE MAXIMUM RATINGS

The absolute maximum stress ratings for the WD6022 devices are tabulated below. Permanent damage to the devices could result from exposing it to conditions exceeding these ratings.

PARAMETER	SYMBOL	MIN	MAX	UNITS
Supply Voltage	$V_{DD} - V_{SS}$	0	7	V
Input Voltage	V_{IABS}	$V_{SS} - 0.3$	$V_{DD} + 0.3$	V
Bias on Output Pin	V_{OABS}	$V_{SS} - 0.3$	$V_{DD} + 0.3$	V
Storage Temperature	T_S	-40	125	°C

3.2 NORMAL OPERATING CONDITIONS

Exposing the WD6022 to conditions exceeding the normal operating conditions for extended periods of time can affect the long-term reliability of the device.

$V_{SS} = 0\text{ V}$

PARAMETER	SYMBOL	MIN	MAX	UNITS
Power Supply Voltage	V_{DD}	4.75	5.25	V
Ambient Temperature	T_A	0	70	°C
Input Voltage	V_{IN}	-0.3	$V_{DD} + 0.3$	V
Power Dissipation	P_W	-	TBD	mW
Supply Current	I_{DD}	-	TBD	mA

3.3 DC CHARACTERISTICS (UNDER NORMAL OPERATING CONDITIONS)

PARAMETER	SYMBOL	MIN	MAX	UNITS
Input Capacitance @ $f_c = 1\text{ MHz}$	C_i	-	5	pF
I/O Capacitance	C_{IO}	-	10	pF
Logic High Input Voltage	V_{IH}	2.0	-	V
Logic Low Input Voltage	V_{IL}	-	0.8	V
Input Leakage	I_{IL}	-	+10	μA
Tristate Output Leakage	I_{OL}	-	+30	μA
I/O Pin Leakage	I_{OIL}	-	+40	μA
WD6022 ADDRESS BUFFER MODE (MODE = 0)				
OUTPUTS PROMCSL, PROMCSH, EOT, UCHCMD, PA(2:31)*				
Source Current @ $V_{OH} = 2.4\text{ V}$	I_{OH}	-	-	mA
Sink Current @ $V_{OL} = 0.4\text{ V}$	I_{OL}	4	-	mA
OUTPUTS BE(0:3), M/IO*				
Source Current @ $V_{OH} = 2.4\text{ V}$	I_{OH}	-	-	mA
Sink Current @ $V_{OL} = 0.4\text{ V}$	I_{OL}	6	-	mA
OUTPUT IOA(0:16)				
Source Current @ $V_{OH} = 2.4\text{ V}$	I_{OH}	-	-	mA
Sink Current @ $V_{OL} = 0.4\text{ V}$	I_{OL}	8	-	mA
ALL OTHER OUTPUTS*				
Source Current @ $V_{OH} = 2.4\text{ V}$	I_{OH}	-	-	mA
Sink Current @ $V_{OL} = 0.4\text{ V}$	I_{OL}	24	-	mA

14



PARAMETER	SYMBOL	MIN	MAX	UNITS
WD6022 DATA BUFFER MODE (MODE = 1)				
OUTPUTS PD(0:31)*				
Source Current @ $V_{OH} = 2.4\text{ V}$	I_{OH}	-	-	mA
Sink Current @ $V_{OL} = 0.4\text{ V}$	I_{OL}	4	-	mA
OUTPUTS IOD(0:15)*				
Source Current @ $V_{OH} = 2.4\text{ V}$	I_{OH}	-	-	mA
Sink Current @ $V_{OL} = 0.4\text{ V}$	I_{OL}	6	-	mA
OUTPUT D(0:31)				
Source Current @ $V_{OH} = 2.4\text{ V}$	I_{OH}	-	-	mA
Sink Current @ $V_{OL} = 0.4\text{ V}$	I_{OL}	24	-	mA

*The following signals are bi-directional: PA(31:2), \overline{BE} (3:0), M/\overline{IO} , MADE24, TR32, MM/\overline{IO} , \overline{MBE} (3:0), A(31:1), SBHE, PD(31:0), IOD(15:0), and D(31:0).

NOTE

- The input pin "BIAS" is connected externally to ground through a 1% 1.25 K ohm resistor, and is part of an internal biasing circuit. Capacitance, leakage, and threshold measurements on this pin do not apply.
- The following signals have internal pullups of 20K: \overline{BE} (3:2), \overline{MBE} (3:0), MM/\overline{IO} , M/\overline{IO} .
- When TEST = 0, all outputs and bi-directional signal lines are tristated.

PARAMETER	SYMBOL	MIN	MAX	UNITS
WD6022 ADDRESS BUFFER MODE (MODE = 0)				
PROMCSL, PROMCSH, EOT, UCHCMD	CL	50	-	pF
\overline{BE} (0:3), M/\overline{IO} *	CL	120	-	pF
PA(2:31), IOA(0:16)*	CL	120	-	pF
MADE24, TR32, MM/\overline{IO} , MMC, \overline{MBE} (0:3), A(1:31), SBHE*	CL	240	-	pF
WD6022 DATA BUFFER MODE (MODE = 1)				
PD(0:31), IOD(0:15)*	CL	120	-	pF
D(0:31)*	CL	240	-	pF

3.4 A.C. LOAD SPECIFICATIONS

*The following signals are bi-directional: PA(31:2), \overline{BE} (3:0), M/\overline{IO} , MADE24, TR32, MM/\overline{IO} , \overline{MBE} (3:0), A(31:1), SBHE, PD(31:0), IOD(15:0), and D(31:0).

NOTE

- The following signals have internal pullups of 20K: \overline{BE} (3:2), \overline{MBE} (3:0), MM/\overline{IO} , M/\overline{IO} .



4.0 TIMING

PARAM	DESCRIPTION	MIN	MAX	UNITS
T1	Propagation Delay			ns
	A1, SBHE, MBE(0:3) to BE(0:3)		28	ns
	PA(2:31), to A(2:32)		26	ns
	A(0:31) to PA(2:31), BE(0:3)		26/28	ns
	A20GTX to A20		26	ns
	M/IO to MM/IO		25	ns
	MM/IO to M/IO		25	ns
T2	TR32, A(0:1), SBHE to MBE(0:3) or BE(0:3)	-	28	ns
	CMD, MMCMD, to UCHCMD	-	20	ns
T3	S(0:1), CMD to EOT	-	25	ns
T4A	M/IO, S(0:1), MADE24, A(0, 31:17)	-	27	ns
T4B	SBHE to PROMCSL, PROMCSH	-	27	ns
	PA(13:17), A20GTX, HLDA, UCHMSTR to PROMCSL, PROMCSH	-	54	ns
T5A	A(0:16), to IOA(0:16)	-	25	ns
T5B	PA(2:16), BE(3:0) to IOA(0:16)	-	50	ns
T6	HLDA to MMC or MADE24	-	25	ns
T7A	Setup to Falling Edge of CMD, MADE24, 5432, M/IO, MM/IO, PA(2:31), BE(0:3), A(0:31), MBE(0:3), SBHE, S(0:1)	10	-	ns
	Setup to Falling Edge of CMD	10	-	ns
	Setup to Falling Edge of CMD	10	-	ns
T7B	A20GTX, UCHMSTR, HLDA	40	-	ns
	Hold from Falling Edge of MCMD, MADE24, TR32, M/IO, MM/IO, PA(2:31), BE(0:3), A(0:31), MBE(0:3), SBHE, S(0:1)	10	-	ns
T8A	Hold from Falling Edge of CMD	10	-	ns
	Hold from Falling Edge of CMD	15	-	ns
T8B	A20GTX, UCHMSTR, HLDA	15	-	ns
T9	CMD Inactive Pulse Width	30	-	ns
T10A	Setup to Rising Edge of CMDBUF	10	-	ns
	Setup to Rising Edge of CMDBUF	10	-	ns
T10B	Setup to Rising Edge of CMD	5	-	ns
T11	Hold from Rising Edge of CMDBUF	5	-	ns
	Hold from Rising Edge of CMDBUF	5	-	ns
T12	CMDBUF Inactive Pulse Width	30	-	ns
T13A	Disable - from UCHMSTR	21	-	ns
	Disable - from UCHMSTR	21	-	ns
	Disable - from UCHMSTR	21	-	ns
T13B	Enable - from UCHMSTR	26	-	ns
	Enable - from UCHMSTR	26	-	ns
	Enable - from UCHMSTR	26	-	ns

Table 3. Address Buffer Mode Timings (ns)



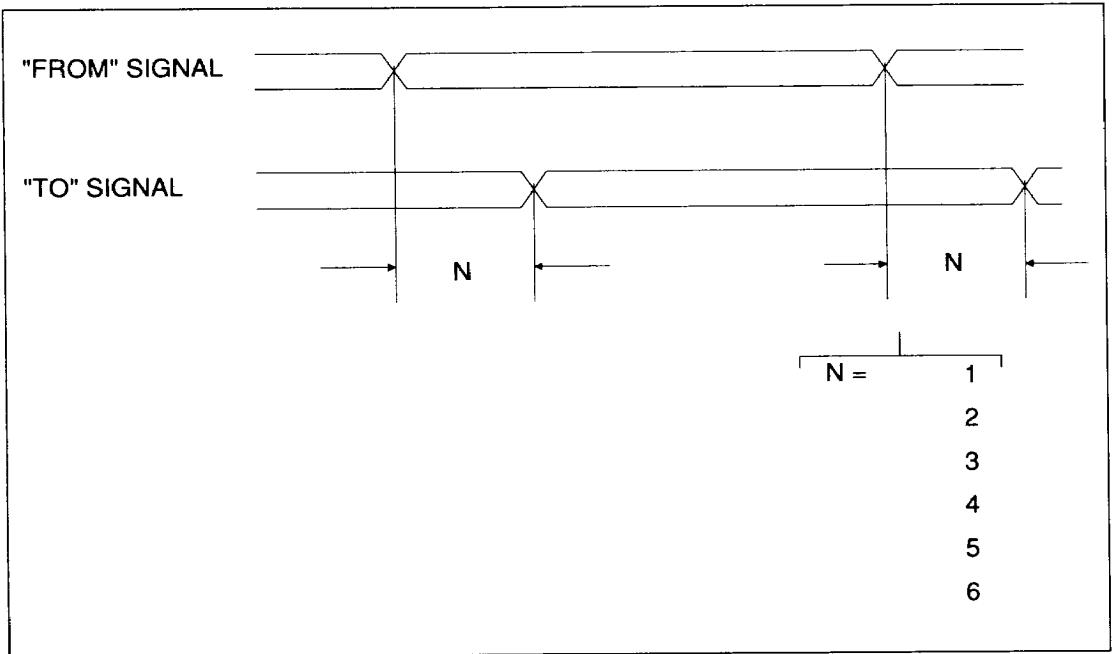

Figure 14. Address Buffer Mode: Propagation Delay Timings

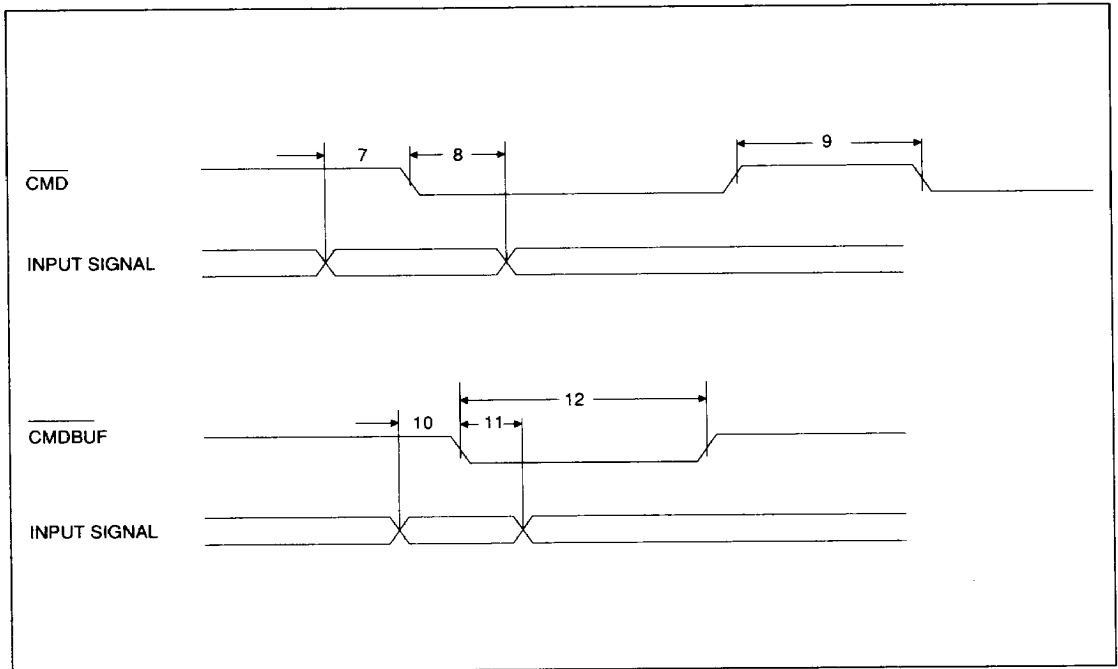

Figure 15. Address Buffer Mode: Latch Timings



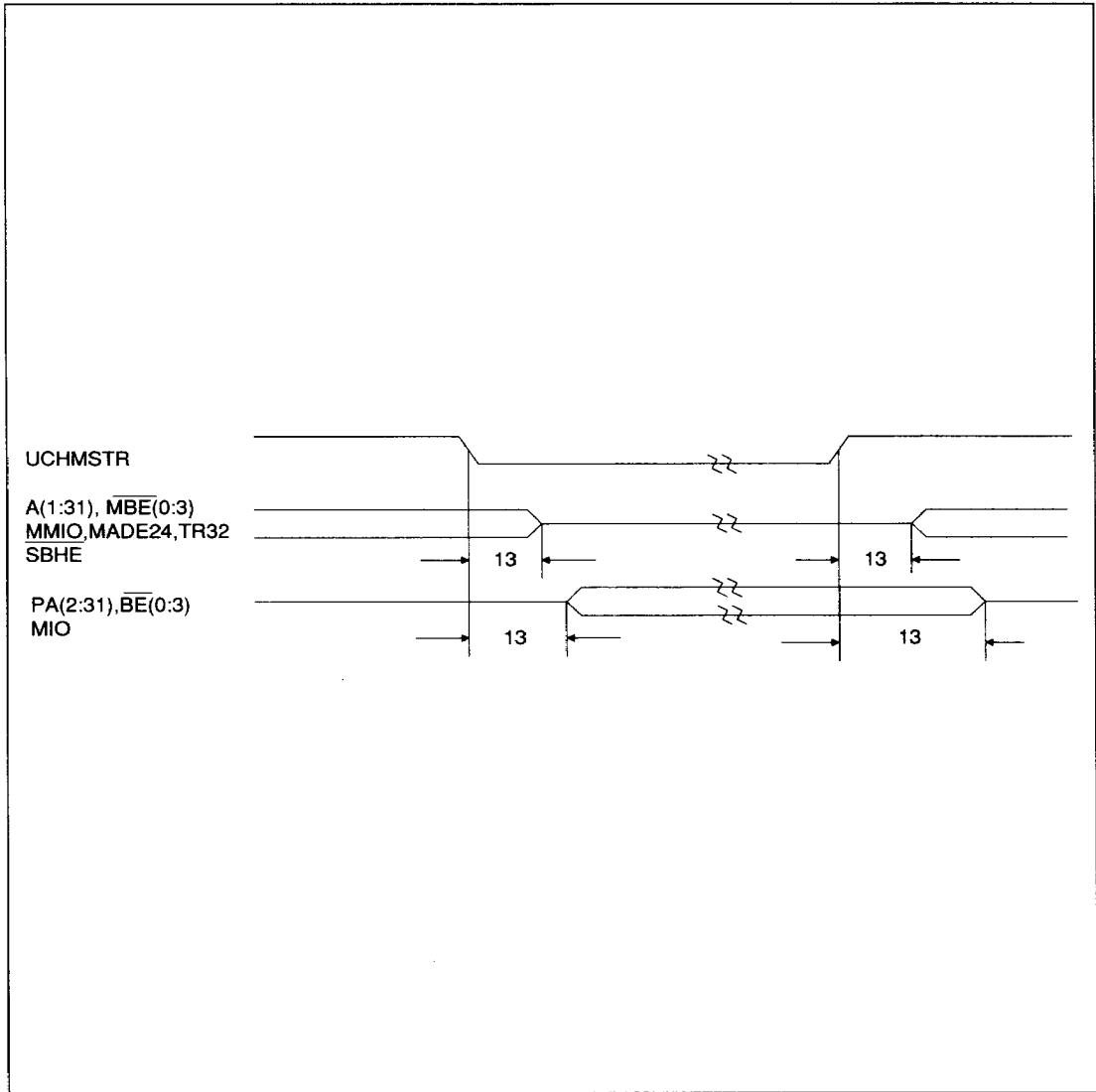

Figure 16. Address Buffer Mode: Float/Enable Timings



PARAM	DESCRIPTION	MIN	MAX	UNITS
T1	Output Enable/Disable	-	-	ns
	$\overline{WREN0}$ to D(0:7)	-	26	ns
	$\overline{WREN1}$ to D(8:15)	-	26	ns
	\overline{WRENH} to D(16:31)	-	26	ns
	\overline{RDEN} to PD(0:31)	-	28	ns
	\overline{IODEN} or \overline{IODTR} to D(0:15) or $\overline{IOD}(0:15)$	-	25	ns
T2	Propagation Delay in Transparent Mode	-	-	ns
	PD(0:31) to D(0:31)	-	26	ns
	D(0:31) to PD(0:31)	-	26	ns
T3	Latch Enable to Data	-	-	ns
	\overline{WRLE} to D(0:31) (\overline{WRENX} active)	-	15	ns
	$\overline{RDLE0}$ to PD(0:7) (\overline{RDENL} active)	-	15	ns
T4A	Data Setup to Latch Enable	-	-	ns
	D(0:7) to $\overline{RDLE0}$	10	-	ns
	$\overline{IOD}(0:15)$ to \overline{IODCBA}	10	-	ns
T4B	Data Setup to Latch Enable	20	-	ns
	PD(0:31) to \overline{WRLE}	20	-	ns
T5	Data Hold from Latch Enable	5	-	ns
	D(0:7) from $\overline{RDLE0}$	5	-	ns
	$\overline{IOD}(0:15)$ from \overline{IODCBA}	5	-	ns
	PD(0:31) from \overline{WRLE}	5	-	ns
T6A	Latch Enable Active Pulse Width	15	-	ns
	\overline{WRLE} , $\overline{RDLE0}$, \overline{IODCBA}	15	-	ns
T6B	Latch Enable Active Pulse Width	30	-	ns
	\overline{WRLE} , $\overline{RDLE0}$, \overline{IODCBA}	30	-	ns
T7	Propagation Delay	-	-	ns
	\overline{SWPDIR} to D() or PD()	-	30/28	ns
	\overline{SWPBYT} to D() or PD()	-	28/28	ns
	$\overline{SWPWORD}$ to D() or PD()	-	28/28	ns

Table 4. Data Buffer Mode Timings (ns)



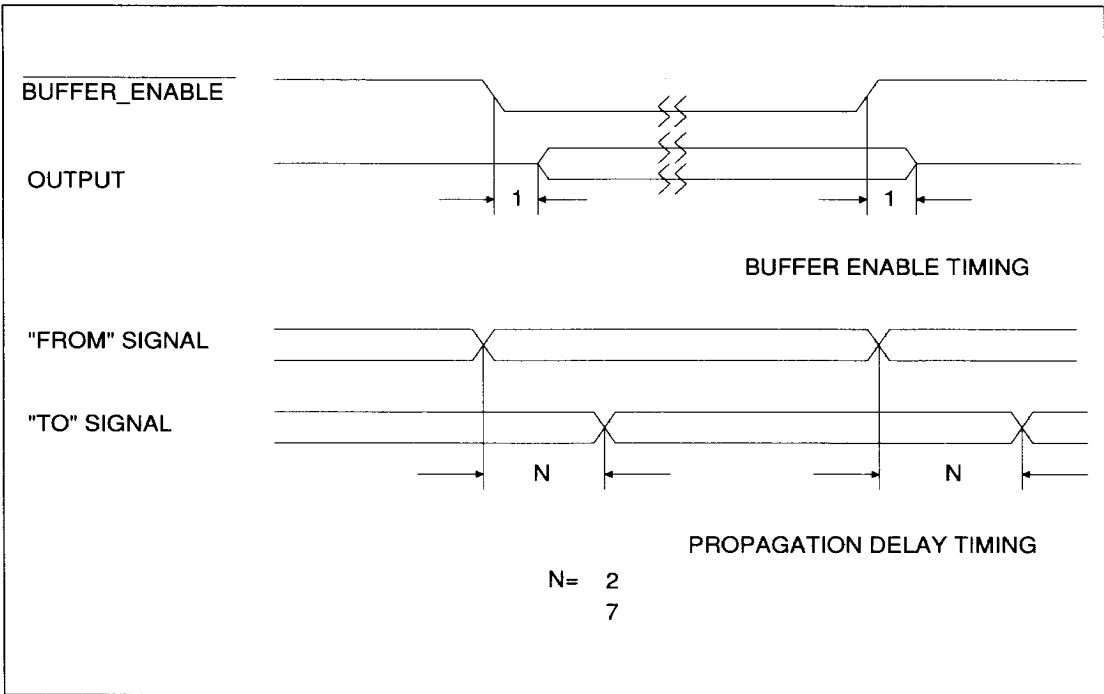

Figure 17. Data Buffer Mode: Propagation Delay Timings

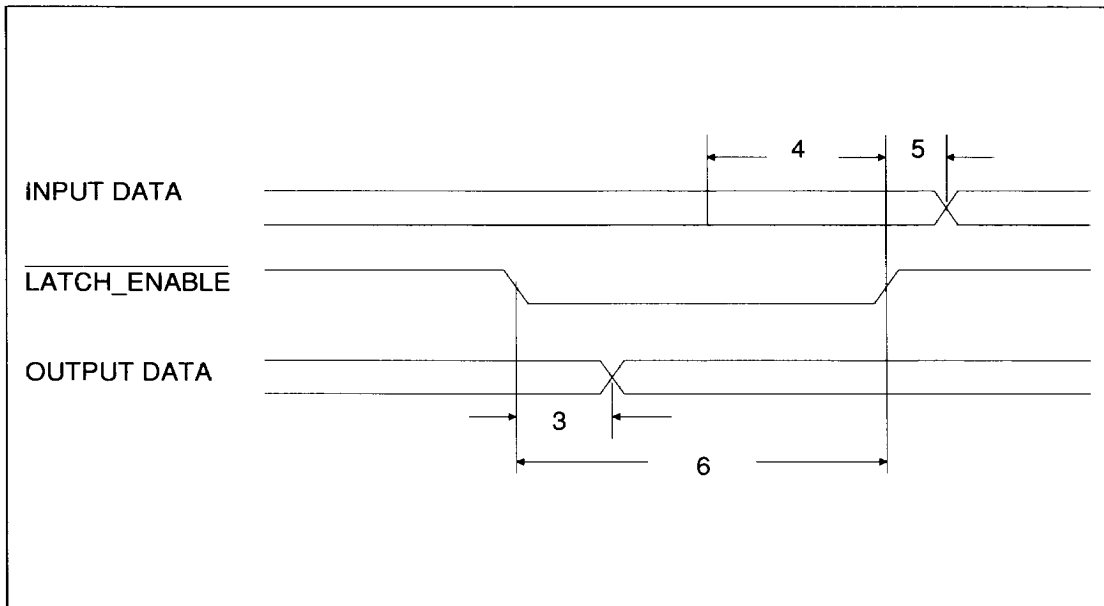
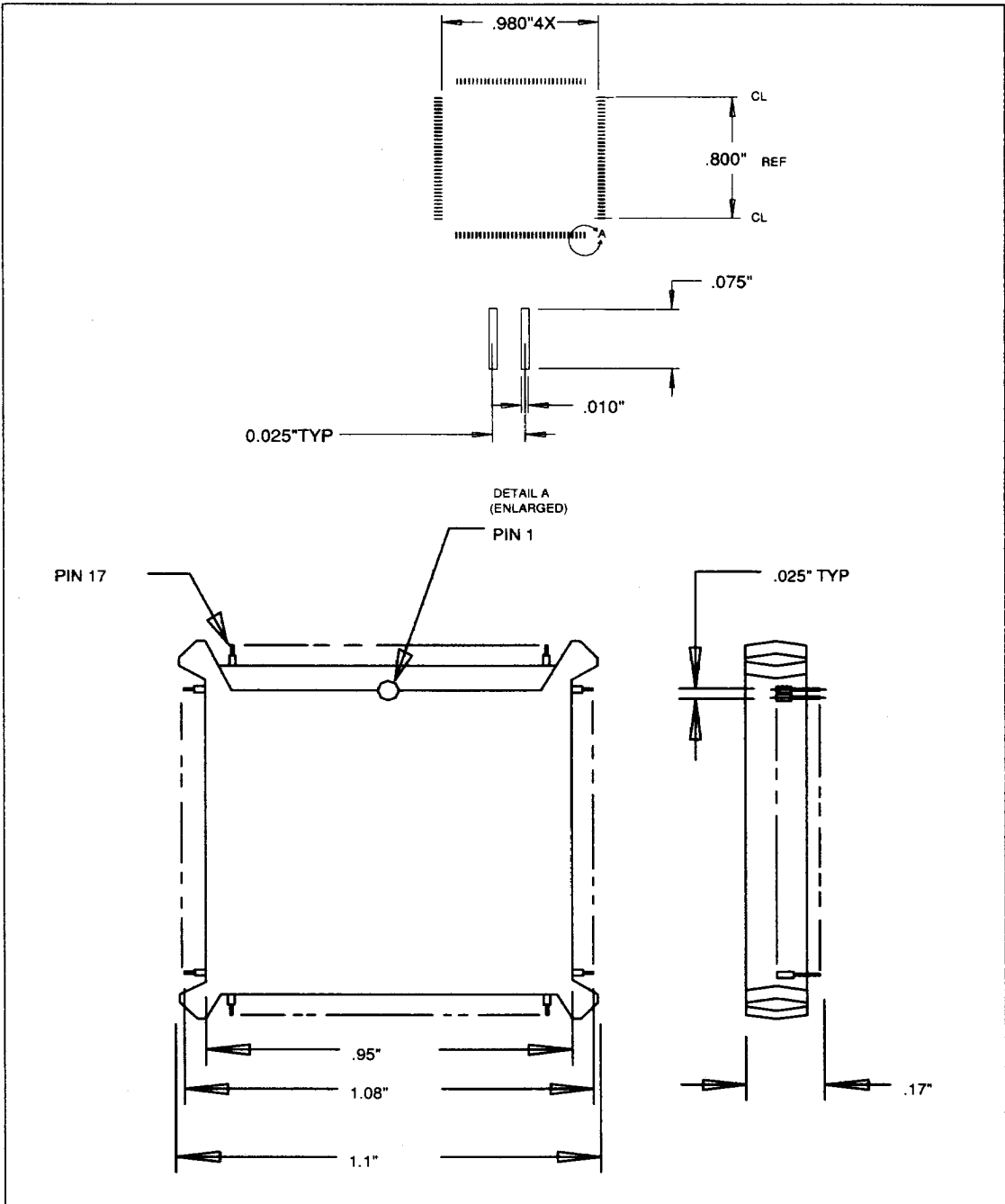

Figure 18. Data Buffer Mode: Latch Timings





14

Figure 21. 132-Pin JEDEC Flat Pack Packaging Diagram



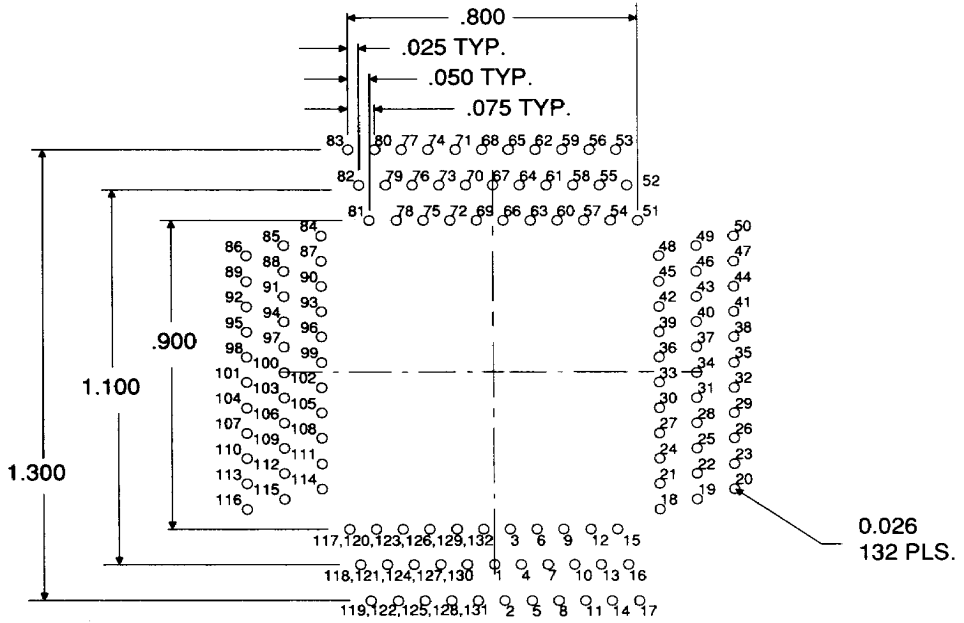

**RECOMMENDED P.C. BOARD HOLE PATTERN
SOCKET SIDE
132 POSN**

Amp Incorporated
Harrisburg PA
Part No. 821932-5

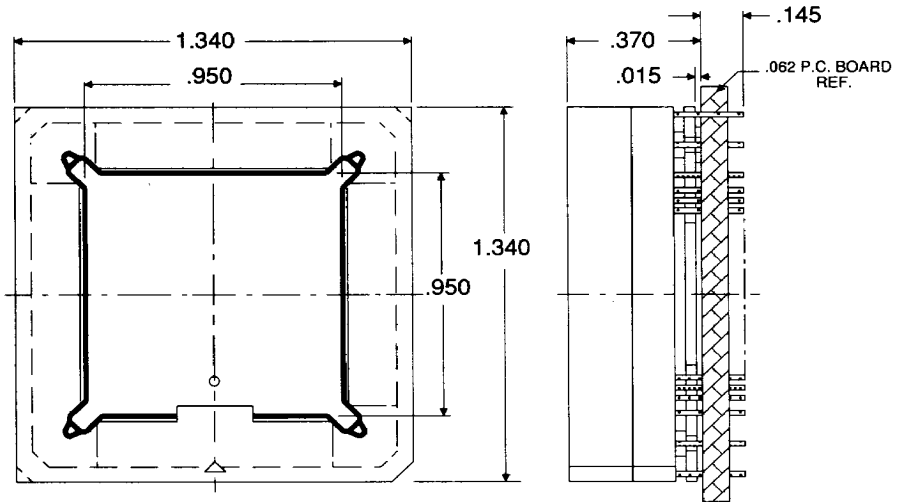

Figure 22. Socket Diagram

