

FEATURES

- Low Noise Figure: NF=1.7dB (MAX.) @ f=20GHz
NF=2.0dB (MAX.) @ f=24GHz
- High Associated Gain: G_{AS} =14dB (MIN.) @ f=20GHz
 G_{AS} =12dB (MIN.) @ f=24GHz
- Wide Frequency Band: 18-24GHz
- LG package for SMT Applications

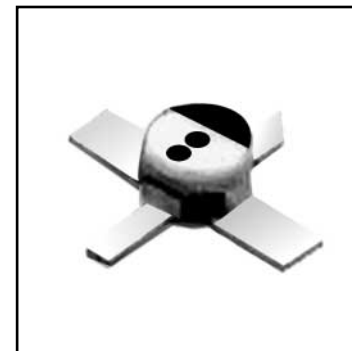

DESCRIPTION

The FMM5701LG is a LNA MMIC designed for applications in the 18-24GHz frequency range. This product is well suited for satellite communications and radio link applications where low noise and high gain is required.

Fujitsu's stringent Quality Assurance Program assures the highest reliability and consistent performance.

ABSOLUTE MAXIMUM RATING (Ambient Temperature $T_a=25^{\circ}\text{C}$)

Item	Symbol	Condition	Rating	Unit
Drain Voltage	V_{DD}		7.0	V
Gate Voltage	V_{GG}		-3.0	V
Storage Temperature	T_{stg}		-55 to +125	$^{\circ}\text{C}$
Operating Case Temperature	T_{op}		-40 to +85	$^{\circ}\text{C}$

ELECTRICAL CHARACTERISTICS (Ambient Temperature $T_a=25^{\circ}\text{C}$)

Item	Symbol	Conditions	Limits			Unit	
			Min.	Typ.	Max.		
Noise Figure	NF	$V_{DD} = 5\text{V}$ $I_D = 12\text{mA}$	f=20GHz	-	-	1.7	dB
			f=24GHz	-	-	2.0	dB
Associated Gain	G_{AS}	$V_{DD} = 5\text{V}$ $I_D = 12\text{mA}$	f=20GHz	14.0	-	-	dB
			f=24GHz	12.0	-	-	dB

CASE STYLE: LG

NF & Gas vs. FREQUENCY

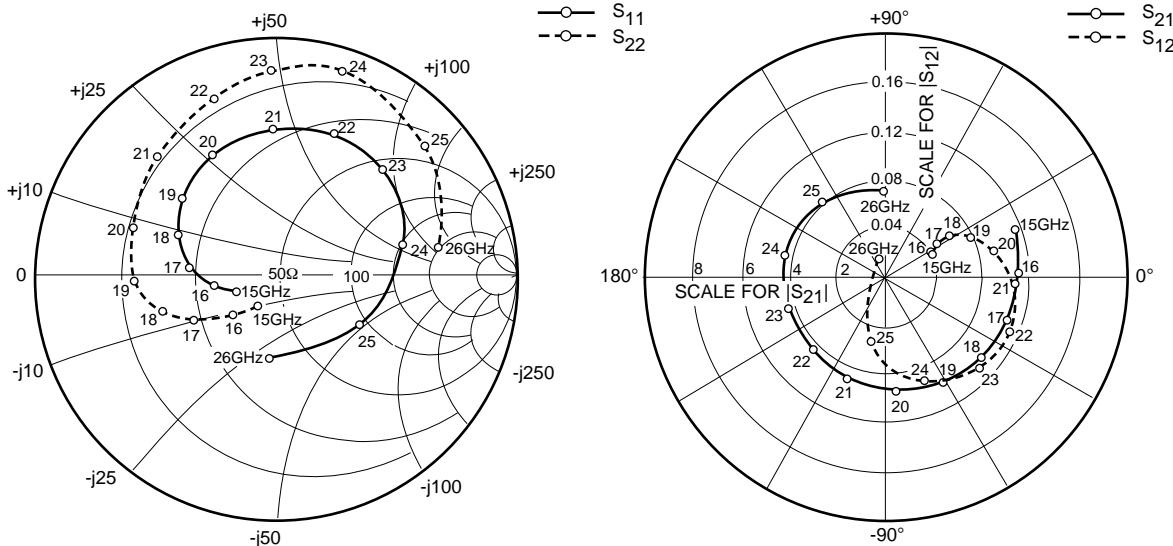
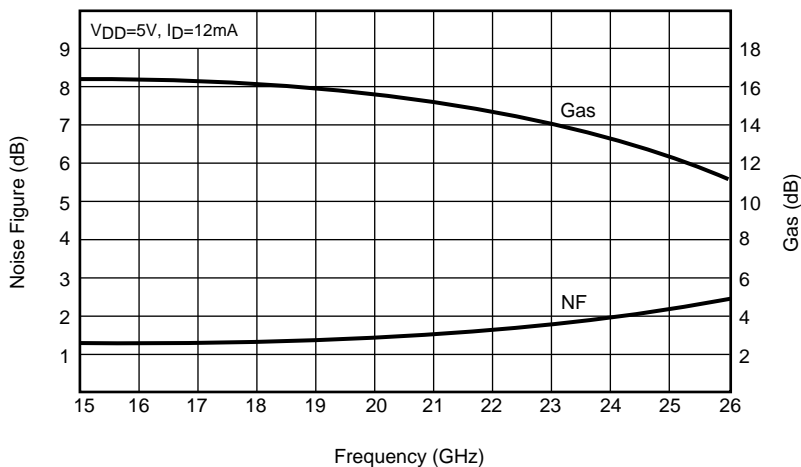

S-PARAMETERS

V_{DD} = 5V, I_D = 12mA

FREQUENCY (MHZ)	S11		S21		S12		S22	
	MAG	ANG	MAG	ANG	MAG	ANG	MAG	ANG
15000	.183	-159.7	5.639	20.6	.042	27.6	.146	-121.7
16000	.264	-172.1	5.375	1.0	.041	29.0	.243	-137.6
17000	.370	176.0	5.233	-19.8	.048	35.7	.387	-152.4
18000	.453	158.2	4.980	-40.8	.061	33.0	.506	-164.8
19000	.511	140.0	4.878	-62.5	.075	25.7	.584	-178.2
20000	.563	117.7	4.743	-86.1	.090	13.5	.624	160.6
21000	.609	92.1	4.535	-111.9	.105	-2.8	.696	134.5
22000	.641	68.0	4.257	-136.1	.110	-23.8	.765	109.6
23000	.627	45.5	4.312	-162.3	.107	-45.0	.851	91.1
24000	.542	14.1	4.359	167.8	.091	-70.1	.893	72.3
25000	.407	-31.6	4.157	130.7	.055	-104.2	.825	41.1
26000	.343	-95.9	3.540	93.1	.015	118.7	.691	9.9

Case Style "LG"
 Metal-Ceramic Hermetic Package

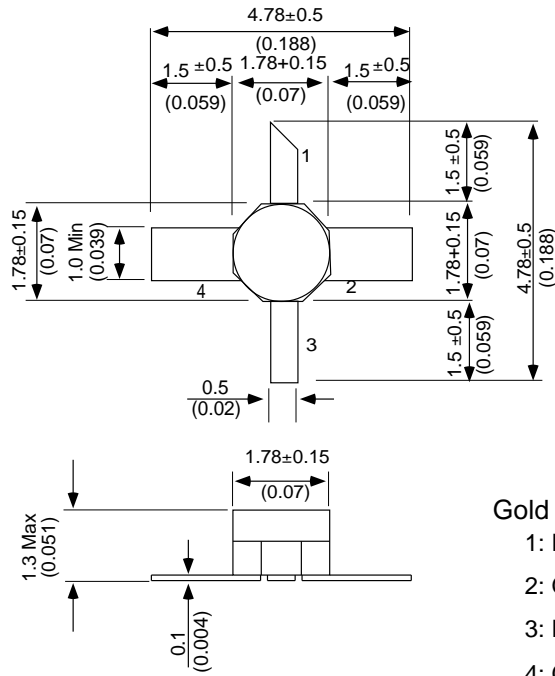

Gold Plated Leads

- 1: RF-IN and V_{GG}
- 2: GND
- 3: RF-OUT and V_{DD}
- 4: GND

Unit: mm (Inches)

FMM5701X

24GHz Low Noise Amplifier MMIC

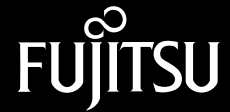

FEATURES

- Low Noise Figure: NF=1.5dB (MAX.) @ f=20GHz
NF=1.8dB (MAX.) @ f=24GHz
NF=2.3dB (MAX.) @ f=28GHz
- High Associated Gain: G_{as} =15.0dB (MIN.) @ f=20GHz
 G_{as} =12.0dB (MIN.) @ f=24GHz
 G_{as} =9.0dB (MIN.) @ f=28GHz
- Wide Frequency Band: 18-28GHz

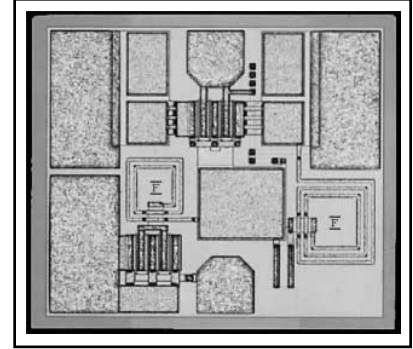

DESCRIPTION

The FMM5701X is a LNA MMIC designed for applications in the 18-28GHz frequency range. This product is well suited for satellite communications and radio link applications where low noise and high gain is required.

Fujitsu's stringent Quality Assurance Program assures the highest reliability and consistent performance.

ABSOLUTE MAXIMUM RATING (Ambient Temperature $T_a=25^\circ\text{C}$)

Item	Symbol	Condition	Rating	Unit
Drain Voltage	V_{DD}		7.0	V
Gate Voltage	V_{GG}		-3.0	V
Storage Temperature	T_{stg}		-65 to +175	$^\circ\text{C}$
Channel Temperature	T_{ch}		+175	$^\circ\text{C}$

ELECTRICAL CHARACTERISTICS (Ambient Temperature $T_a=25^\circ\text{C}$)

Item	Symbol	Conditions (2)	Limits			Unit	
			Min.	Typ.	Max.		
Noise Figure	NF	$V_{DD} = 5V$ $I_D = 12mA$	f=20GHz	-	-	1.5	dB
			f=24GHz	-	-	1.8	dB
			f=28GHz	-	-	2.3	dB
Associated Gain	G_{as}	$V_{DD} = 5V$ $I_D = 12mA$	f=20GHz	15.0	-	-	dB
			f=24GHz	12.0	-	-	dB
			f=28GHz	9.0	-	-	dB

Note 1: RF parameters sample size 10pcs. criteria (accept/reject) = (2/3)

Note 2: Tuned for Γ_{opt}

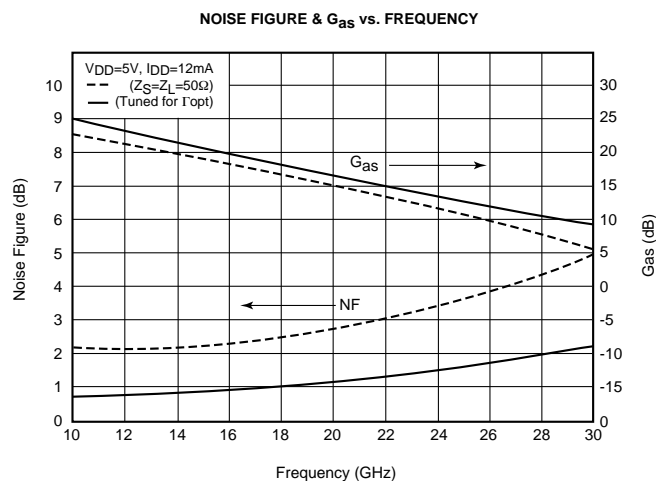

S-PARAMETERS

$V_{DD} = 5V, I_{DS} = 12mA$

FREQUENCY (MHZ)	S11		S21		S12		S22	
	MAG	ANG	MAG	ANG	MAG	ANG	MAG	ANG
15000	.395	-155.5	13.439	109.5	.016	23.7	.237	164.0
16000	.417	-166.9	12.411	92.1	.018	22.9	.195	151.1
17000	.448	179.8	10.757	78.2	.019	21.4	.180	139.2
18000	.468	167.1	9.737	63.8	.023	22.0	.148	129.8
19000	.500	155.5	8.678	48.8	.027	19.3	.131	124.6
20000	.537	143.4	7.901	36.4	.029	15.7	.132	121.0
21000	.581	132.6	7.195	23.5	.035	6.2	.137	124.3
22000	.636	122.2	6.745	10.4	.039	-4.1	.160	125.4
23000	.663	111.8	6.696	-1.6	.044	-5.8	.168	123.1
24000	.721	101.2	6.188	-15.3	.050	-8.6	.194	120.7
25000	.802	89.2	5.462	-29.4	.057	-20.7	.242	115.1
26000	.872	77.7	5.255	-45.0	.063	-31.3	.293	108.3
27000	.922	65.6	4.781	-58.5	.069	-42.6	.339	99.6
28000	.949	52.9	4.464	-72.6	.066	-54.3	.377	88.2
29000	.961	40.8	3.770	-88.8	.068	-67.1	.396	76.4
30000	.942	30.8	3.349	-100.0	.061	-73.6	.397	68.3

NOTE:* The data includes bonding wires.

n: number of wires

RF IN n=1 (0.3mm length, 25µm Dia Au wire)

RF OUT n=1 (0.3mm length, 25µm Dia Au wire)

GND n=6 (0.3mm length, 25µm Dia Au wire)

BONDING LAYOUT

