

DESCRIPTION

The UM7000 and UM7100 series offer moderately high power handling in combination with reasonably low levels of both series resistance and capacitance. The UM7200 series offers the lowest series resistance, but the highest capacitance of the group. The differences in specified performance for each of the series, results from different I-region thickness. The three series have broad applicability in many RF and microwave switch and attenuator circuits. Additionally, the UM7100 in leaded versions is usually the most cost-effective diode choice in high volume usage.

KEY FEATURES

- Voltage ratings to 1000V (UM7000)
- Average power dissipation to 10 W
- Series resistance as low as 0.25 Ω
- Carrier lifetime greater than 2.5 μ s
- Low capacitance
- Low conductance (High R_p)
- Compatible with automated assembly
- RoHS compliant packaging Available¹ (Use UMX7202B, etc.)

IMPORTANT:

For the most current data, consult MICROSEMI's website: www.MICROSEMI.com

¹ The UM7000 series of products can be supplied with a RoHS compliant finish (UMX7000) or with a 90/10 Sn/Pb finish. Stud Packages C/CR/D/DR are supplied with a RoHS complaint Gold finish Consult factory for details.

ABSOLUTE MAXIMUM RATINGS AT 25° C (UNLESS OTHERWISE SPECIFIED)

Package	Conditions	(P_D) Power Dissipation (W)	(Θ) Thermal Resistance ($^{\circ}$ C/W)
A	25 $^{\circ}$ C Pin Temperature	10	15V
B	½ in. total length to 25 $^{\circ}$ C Contact Free Air	5.5	27.5
E		1.5	
C	25 $^{\circ}$ C Stud Temperature	10	15
D	25 $^{\circ}$ C Stud Temperature	7.5	20
SM	25 $^{\circ}$ C End Cap Temperature	8	17
ALL	1 μ s pulse (Single)	100KW	60 kW 35 kW 20 kW
ALL	Storage Temperature (T_{OP})	-65 $^{\circ}$ C to + 175 $^{\circ}$ C	
ALL	Operating Temperature (T_{OP})	-65 $^{\circ}$ C to + 175 $^{\circ}$ C	

APPLICATIONS/BENEFITS

- Isolated stud package available
- Surface mount package available
- Soldering temperature: 260 $^{\circ}$ C for 10 seconds maximum

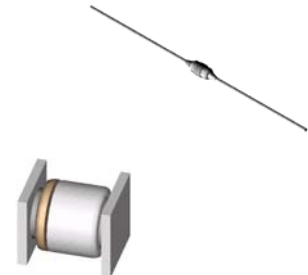



UM7000 / UM7100 / UM7200

HIGH POWER PIN DIODES

RoHS Compliant Versions Available



VOLTAGE RATINGS

@ 25°C (unless otherwise specified)

Part Number			Reverse Voltage @ 10uA (V)
UM7001	UM7101	UM7201	100
UM7002	UM7102	UM7202	200
-	UM7104	UM7204	400
UM7006	-	-	600
-	UM7108	-	800
UM7010	-	-	1000

ELECTRICAL PARAMETERS @ 25°C (unless otherwise specified)

Parameter	Symbol	Conditions	UM7000	UM7100	UM7200	Units
Reverse Current (Max)	I_R	At rated voltage	10	10	10	uA
Series Resistance(Max)	R_S	$I_F = 100 \text{ mA}$, $F = 100 \text{ MHz}$	1.0	0.6	0.25	Ohm
Capacitance (Max)	C_T	$V_R = 100 \text{ V}$, $F = 1 \text{ MHz}$	0.9	1.2	2.2	pF
Parallel Resistance(Min)	R_P	$V_R = 100 \text{ V}$, $F = 100 \text{ MHz}$	200k	150k	70k	Ohms
Carrier Lifetime(Min)	T_L	$I_F = 10 \text{ mA}$	2.5	2.0	1.5	uS
I-Region Width (Min)	W	-	150	80	40	um

See following pages for performance graphs and mechanical data.

RoHS Compliant Versions Available

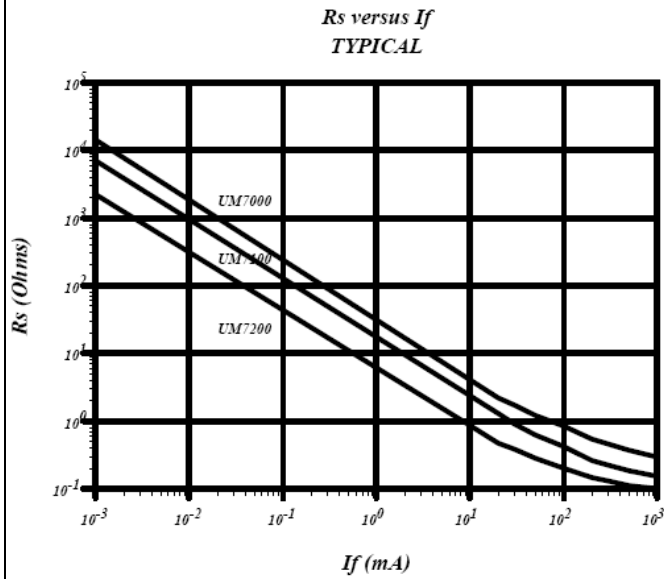
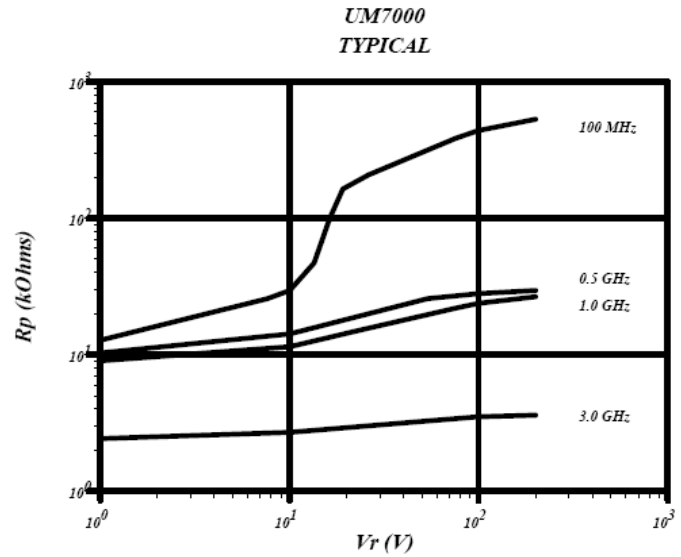
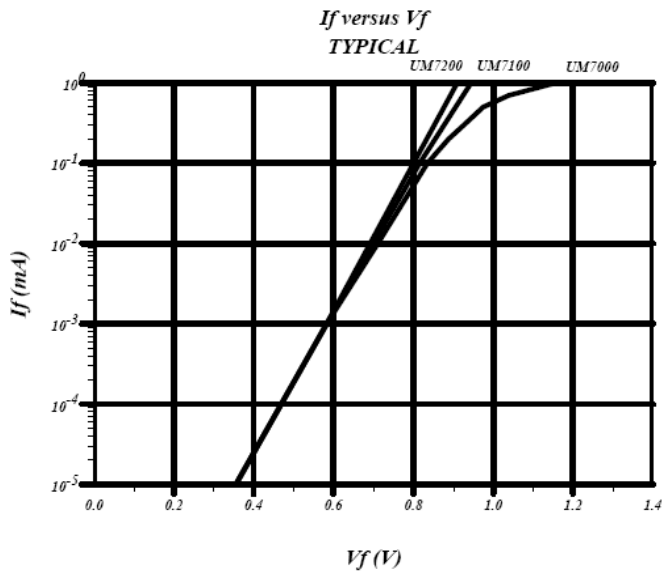
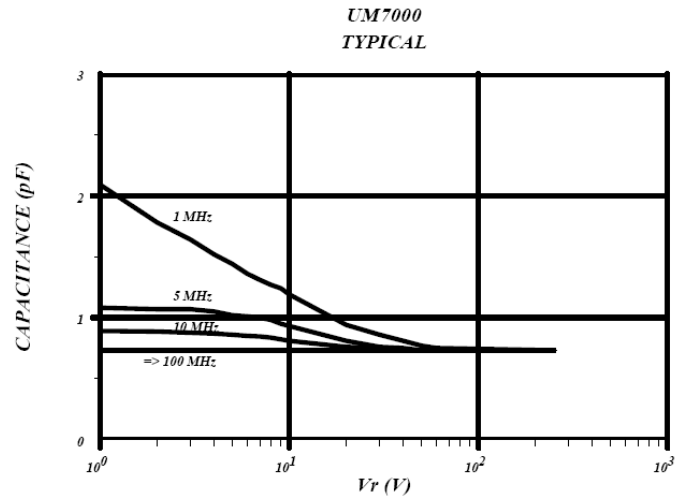

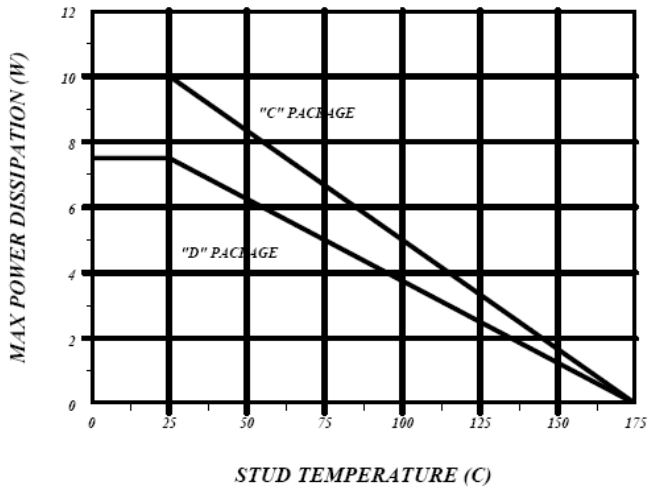
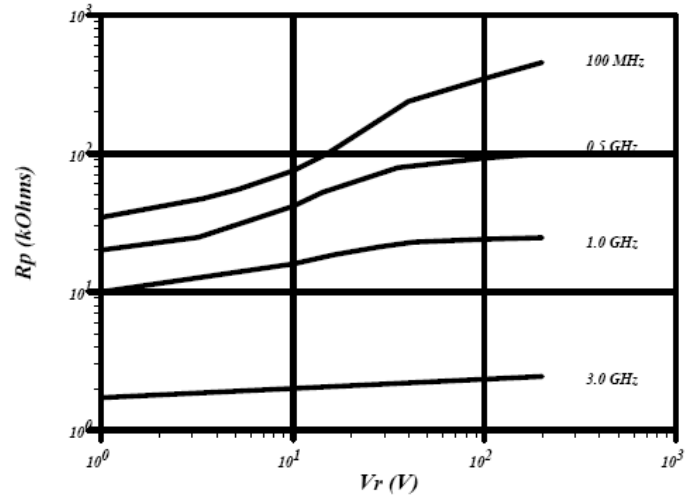
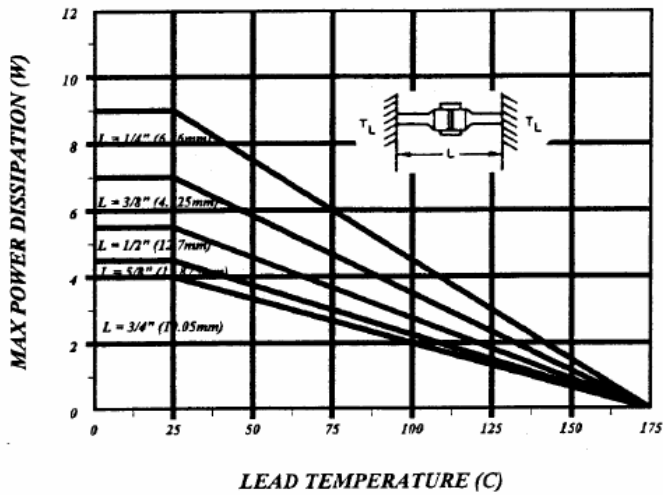
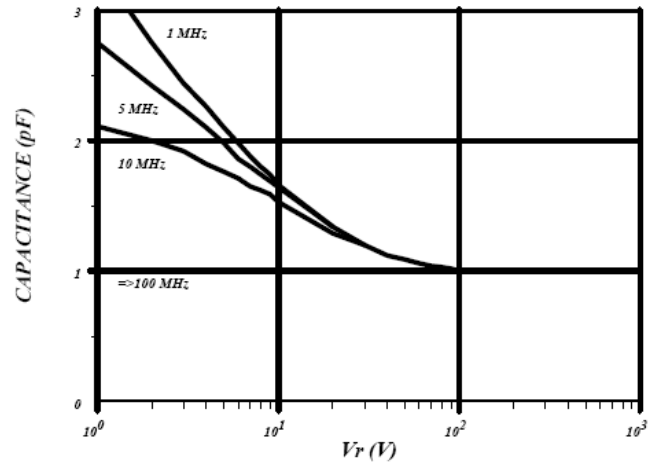
TYPICAL RS VS IF

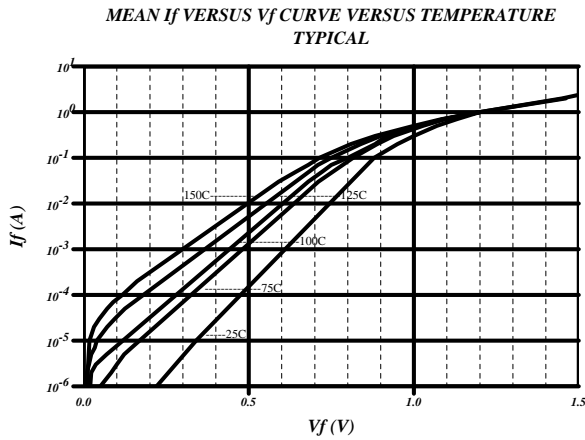
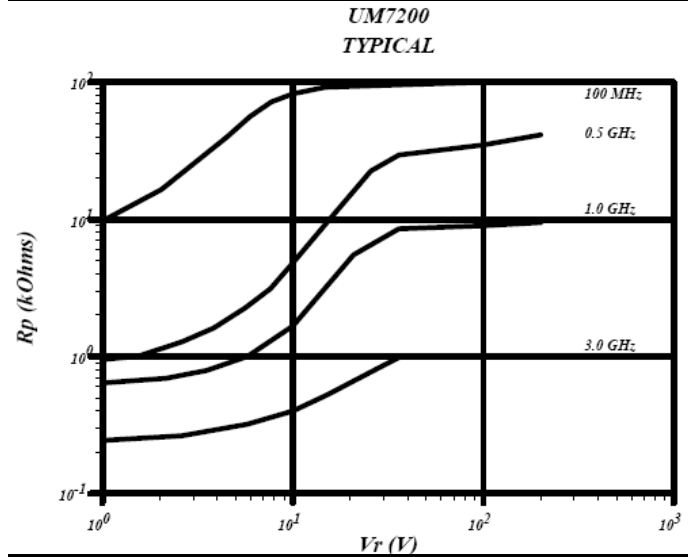
TYPICAL RP VS VOLTAGE

IF VS VF

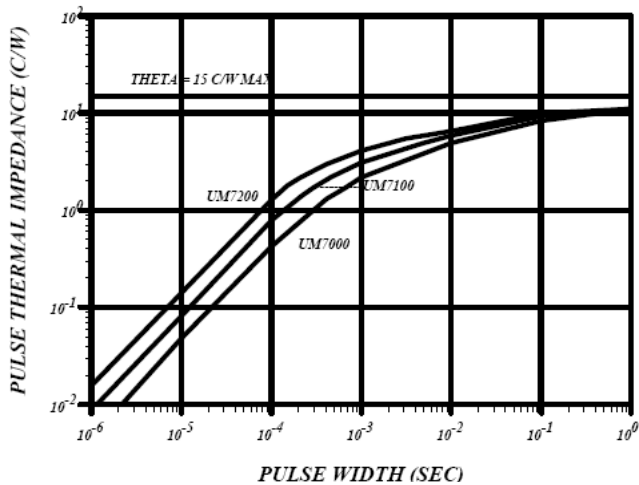
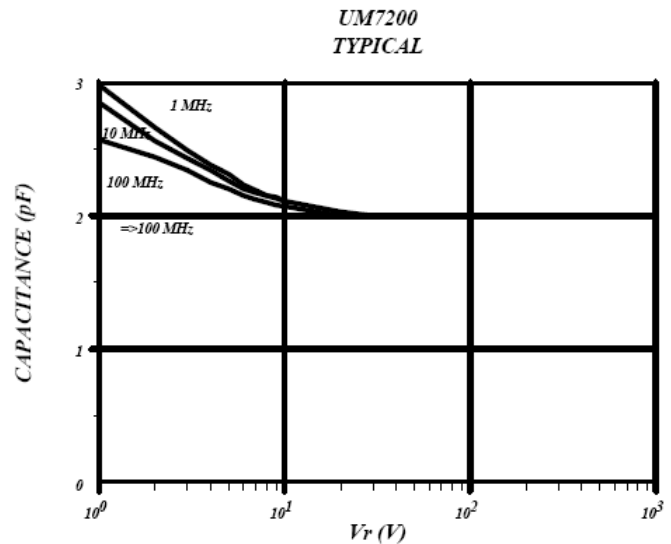
CAPACITANCE VS VOLTAGE

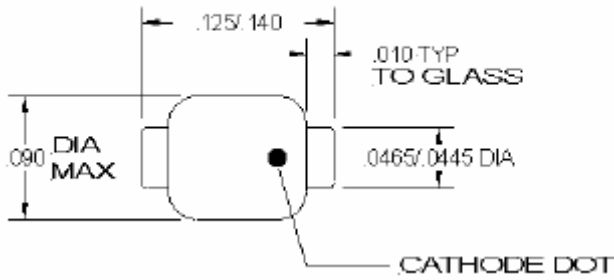
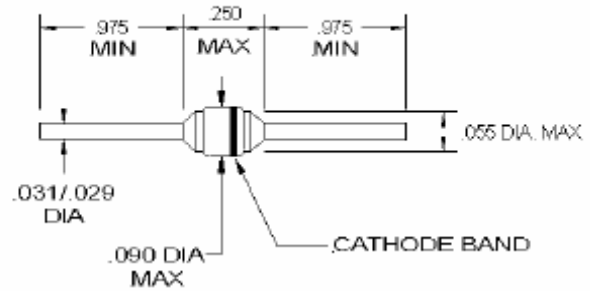
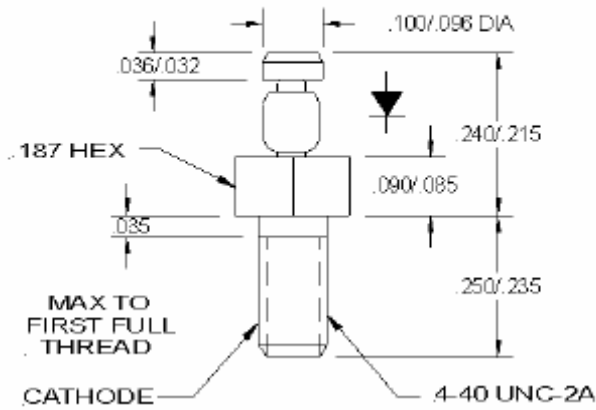
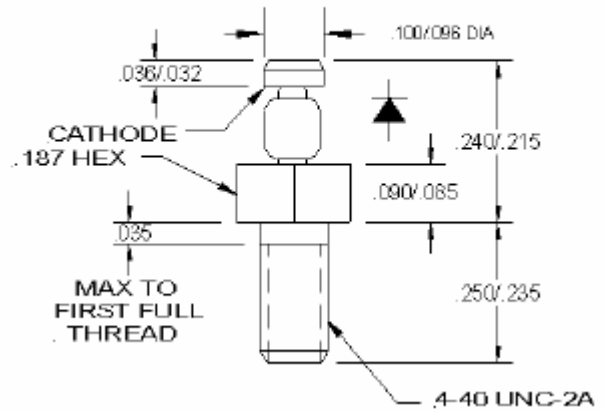
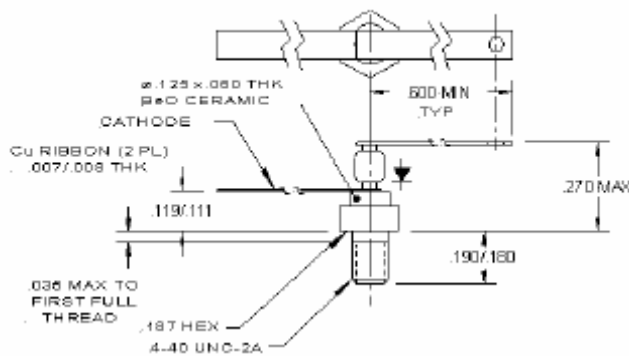
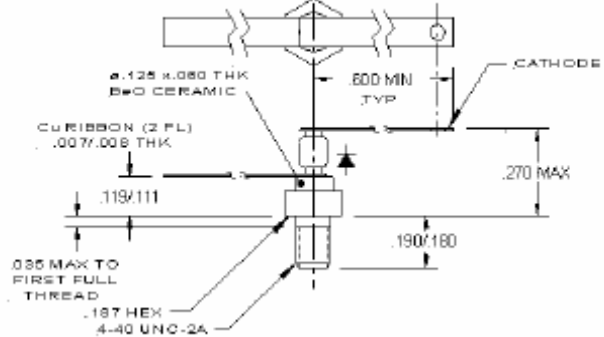
POWER RATING
**POWER RATING STUD MOUNTED DIODES
TYPICAL**

TYPICAL RP VS VOLTAGE
**UM7100
TYPICAL**

POWER RATING
**POWER RATING AXIAL LEADED DIODES
TYPICAL**

CAPACITANCE VS VOLTAGE
**UM7100
TYPICAL**

I/V VS TEMP

TYPICAL RP VS VOLTAGE

THERMAL IMPEDANCE

PULSE THERMAL IMPEDANCE VERSUS WIDTH
TYPICAL

CAPACITANCE VS VOLTAGE

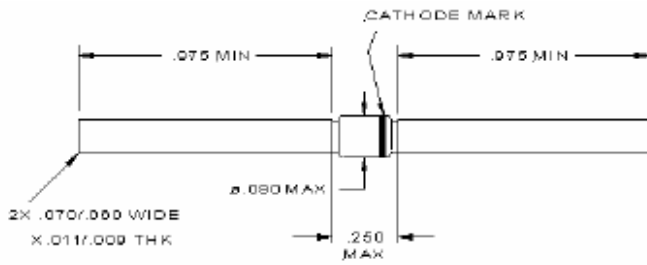
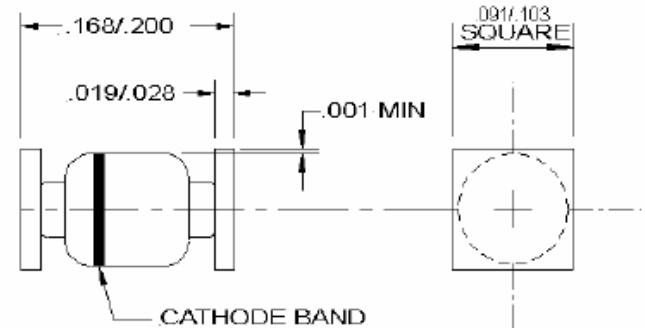
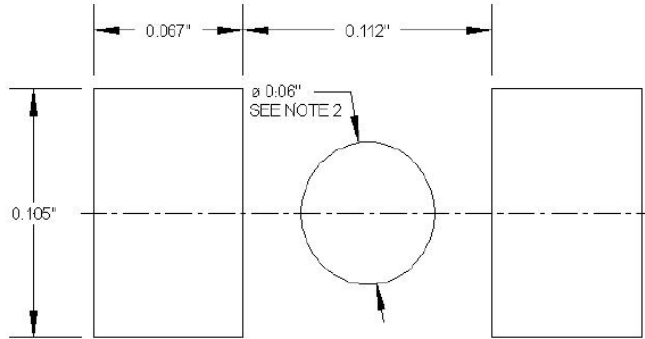
PACKAGE STYLE 'A'
STYLE "A"

PACKAGE STYLE 'B'
STYLE "B"

PACKAGE STYLE 'C'
STYLE "C"

PACKAGE STYLE 'CR'
STYLE "CR"

PACKAGE STYLE 'D'

PACKAGE STYLE 'DR'

RoHS Compliant Versions Available

PACKAGE STYLE 'E'

PACKAGE STYLE 'SM'

STYLE 'SM' FOOTPRINT

NOTES:

- 1 These dimensions will match the terminals and provide for additional solder fillets at the outboard ends at least as wide as the terminals themselves, assuming accuracy of placement within 0.005"
- 2 If the mounting method chosen requires use of an adhesive separate from the solder compound, a round (or square) spot of cement as shown should be centrally located.