



**ZXTN10150DZ**

**150V NPN LED DRIVING TRANSISTOR IN SOT89**

**Features**

- $BV_{CEO} > 150V$
- $h_{FE} > 100$  for  $I_C = 150mA$ ,  $V_{CE} = 0.25V$
- $I_C (cont) = 1A$
- **Lead Free, RoHS Compliant (Note 1)**
- **Halogen and Antimony Free "Green" Device (Note 2)**
- **Qualified to AEC-Q101 Standards for High Reliability**

**Mechanical Data**

- Case: SOT-89
- Case Material: Molded Plastic. "Green" Molding Compound.
- UL Flammability Rating 94V-0
- Moisture Sensitivity: Level 1 per J-STD-020
- Terminals: Matte Tin Finish
- Weight: 0.008 grams (Approximate)

**Applications**

- LED TV backlight

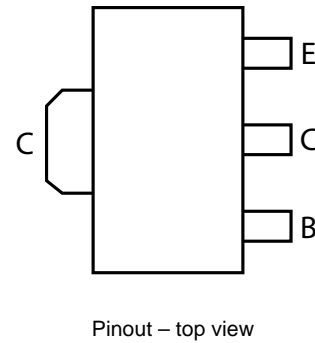
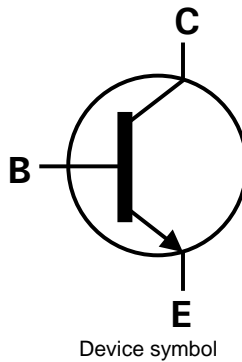
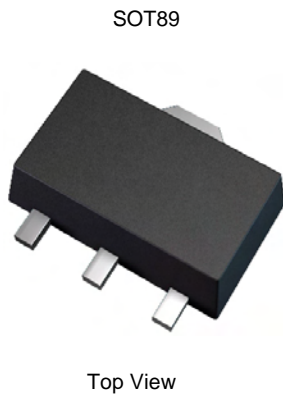

**Ordering Information**

Product	Marking	Reel size (inches)	Tape width (mm)	Quantity per reel
ZXTN10150DZTA	1R4	7	12	1000

- Notes:
1. No purposefully added lead.
  2. "Green" devices, Halogen and Antimony Free, Diodes Inc's "Green" Policy can be found on our website at <http://www.diodes.com>

**Marking Information**

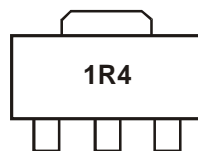

1R4 - Product Type Marking Code

**Maximum Ratings** @ $T_A = 25^\circ\text{C}$  unless otherwise specified

Characteristic	Symbol	Value	Unit
Collector-Base Voltage	$V_{CBO}$	150	V
Collector-Emitter Voltage	$V_{CEO}$	150	V
Emitter-Base Voltage	$V_{EBO}$	7	V
Continuous Collector Current	$I_C$	1	A
Peak Pulse Current (Note 4)	$I_{CM}$	3	A
Base Current	$I_B$	500	mA

**Thermal Characteristics** @ $T_A = 25^\circ\text{C}$  unless otherwise specified

Characteristic	Symbol	Value	Unit
Power Dissipation (Note 3)	$P_D$	1.5	W
Thermal Resistance, Junction to Ambient (Note 3)	$R_{\theta JA}$	83	$^\circ\text{C/W}$
Thermal Resistance, Junction to Leads	$R_{\theta JL}$	6.36	$^\circ\text{C/W}$
Operating and Storage Temperature Range	$T_J, T_{STG}$	-55 to +150	$^\circ\text{C}$

Notes: 3. For a device surface mounted on 25mm X 25mm FR4 PCB with high coverage of single sided 1 oz copper, in still air conditions.  
4. Measured under pulsed conditions. Pulse width = 300 $\mu\text{s}$ . Duty cycle  $\leq 2\%$ .

**Thermal Characteristics and Derating information**

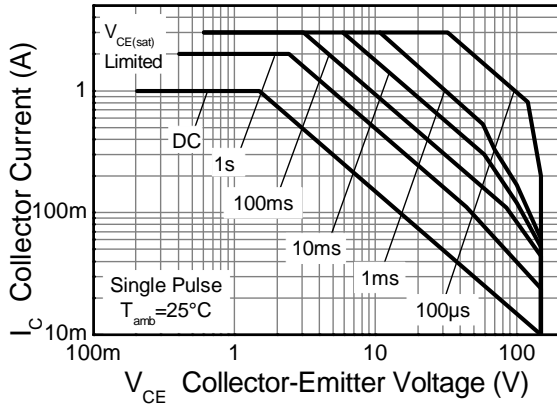

**Safe Operating Area**

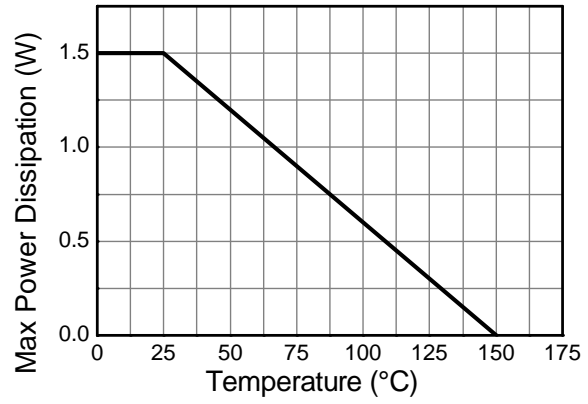

**Derating Curve**

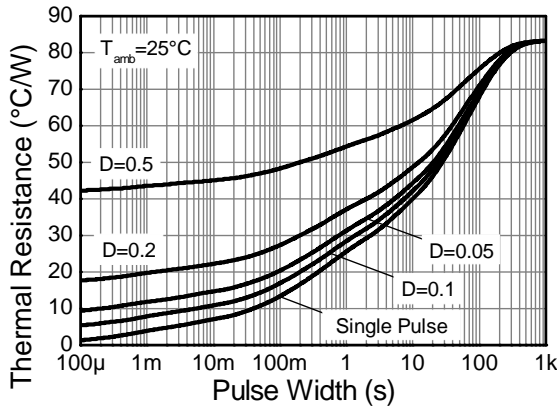

**Transient Thermal Impedance**

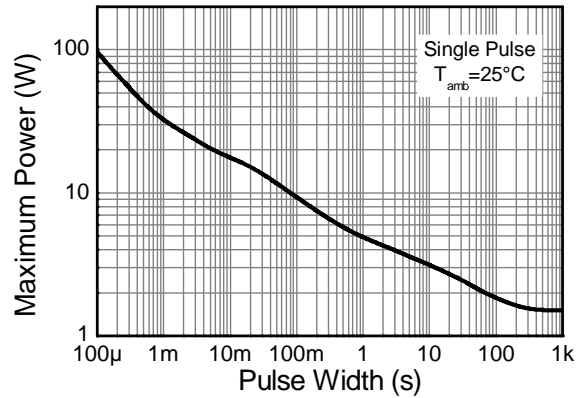

**Pulse Power Dissipation**

**Electrical Characteristics** @T<sub>A</sub> = 25°C unless otherwise specified

Characteristic	Symbol	Min	Typ	Max	Unit	Test Condition
Collector-Base Breakdown Voltage	BV <sub>CBO</sub>	150	300	-	V	I <sub>C</sub> = 100μA
Collector-Emitter Breakdown Voltage (Note 5)	BV <sub>CEO</sub>	150	175	-	V	I <sub>C</sub> = 10mA
Emitter-Base Breakdown Voltage	BV <sub>EBO</sub>	7	8.3	-	V	I <sub>E</sub> = 100μA
Collector Cut-off Current	I <sub>CBO</sub>	-	-	50	nA	V <sub>CB</sub> = 150V
Emitter Cut-off Current	I <sub>EBO</sub>	-	-	50	nA	V <sub>EB</sub> = 7V
Static Forward Current Transfer Ratio (Note 5)	h <sub>FE</sub>	200 60 100	450 180 150	- - -	-	I <sub>C</sub> = 30mA, V <sub>CE</sub> = 5V I <sub>C</sub> = 85mA, V <sub>CE</sub> = 0.20V I <sub>C</sub> = 150mA, V <sub>CE</sub> = 0.25V
Base-Emitter Turn-On Voltage (Note 5)	V <sub>BE(on)</sub>	-	0.701	0.95	V	I <sub>C</sub> = 150mA, V <sub>CE</sub> = 0.25V
Output Capacitance	C <sub>OBO</sub>	-	10	-	pF	V <sub>CB</sub> = 10V, f = 1MHz
Current Gain-Bandwidth Product	f <sub>t</sub>	-	135	-	MHz	V <sub>CB</sub> = 10V, I <sub>C</sub> = 10mA, f = 100MHz
Delay Time	t <sub>(d)</sub>	-	625	-	ns	V <sub>CC</sub> = 110V, I <sub>C</sub> = 150mA, -I <sub>B2</sub> = 1.5mA, V <sub>CE(ON)</sub> = 0.25V
Rise Time	t <sub>(r)</sub>	-	562	-	ns	
Storage Time	t <sub>(s)</sub>	-	2465	-	ns	
Fall Time	t <sub>(f)</sub>	-	289	-	ns	V <sub>CC</sub> = 110V, I <sub>C</sub> = 150mA, -I <sub>B2</sub> = 1.5mA, V <sub>CE(ON)</sub> = 4V
Storage Time	t <sub>(s)</sub>	-	461	-	ns	
Fall Time	t <sub>(f)</sub>	-	52	-	ns	

Notes: 5. Measured under pulsed conditions. Pulse width = 300μs. Duty cycle ≤ 2%

**Typical Characteristics**

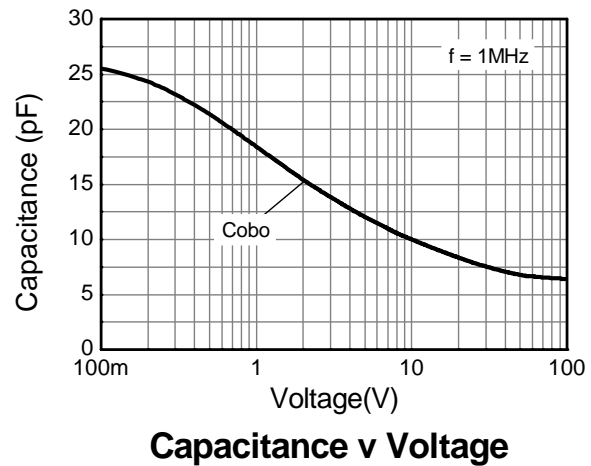
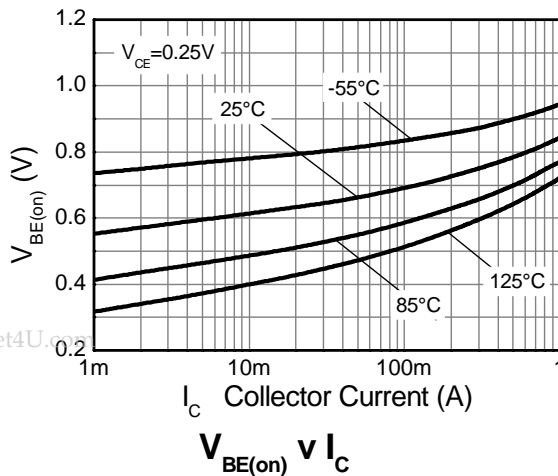
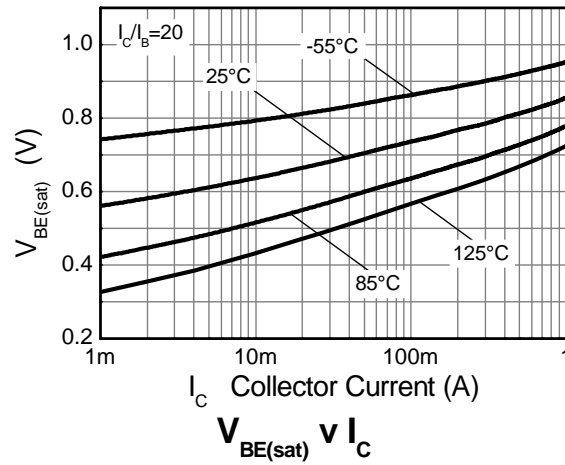
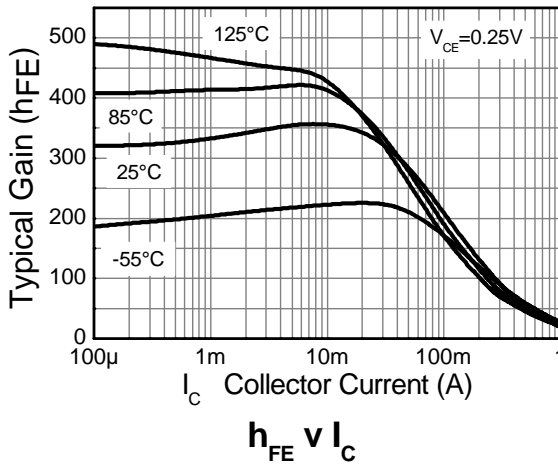
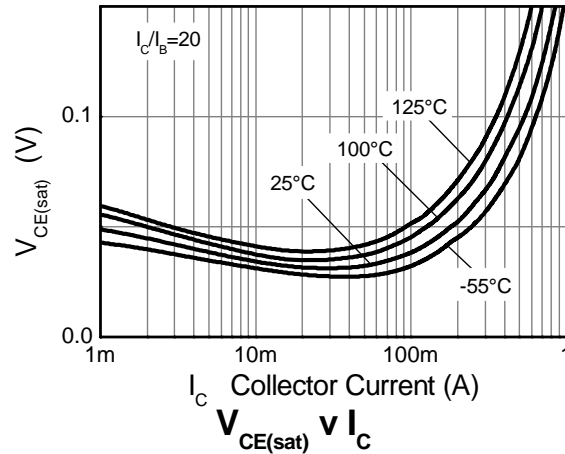
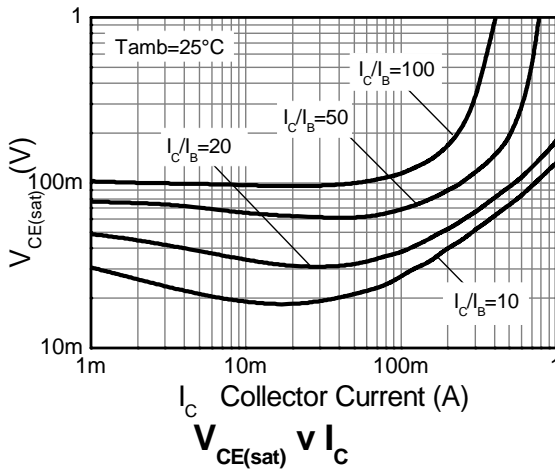

www.DataSheet4U.com

**Package Outline Dimensions**

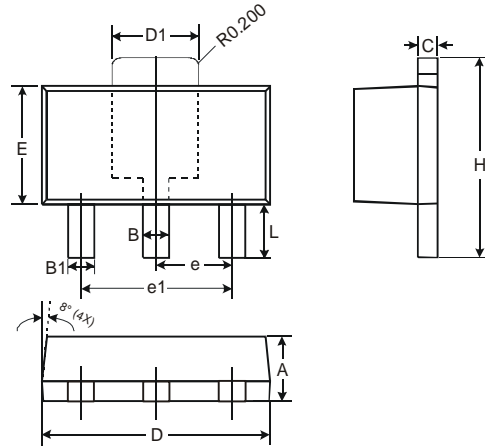

SOT89-3L		
Dim	Min	Max
A	1.40	1.60
B	0.44	0.62
B1	0.35	0.54
C	0.35	0.43
D	4.40	4.60
D1	1.52	1.83
E	2.29	2.60
e	1.50 Typ	
e1	3.00 Typ	
H	3.94	4.25
L	0.89	1.20
All Dimensions in mm		

**Suggested Pad Layout**

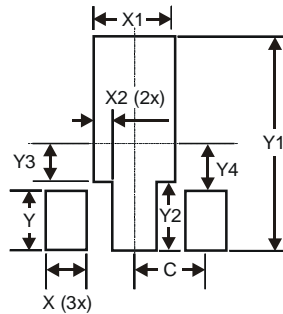

Dimensions	Value (in mm)
X	0.900
X1	1.733
X2	0.416
Y	1.300
Y1	4.600
Y2	1.475
Y3	0.950
Y4	1.125
C	1.500

**IMPORTANT NOTICE**

DIODES INCORPORATED MAKES NO WARRANTY OF ANY KIND, EXPRESS OR IMPLIED, WITH REGARDS TO THIS DOCUMENT, INCLUDING, BUT NOT LIMITED TO, THE IMPLIED WARRANTIES OF MERCHANTABILITY AND FITNESS FOR A PARTICULAR PURPOSE (AND THEIR EQUIVALENTS UNDER THE LAWS OF ANY JURISDICTION).

Diodes Incorporated and its subsidiaries reserve the right to make modifications, enhancements, improvements, corrections or other changes without further notice to this document and any product described herein. Diodes Incorporated does not assume any liability arising out of the application or use of this document or any product described herein; neither does Diodes Incorporated convey any license under its patent or trademark rights, nor the rights of others. Any Customer or user of this document or products described herein in such applications shall assume all risks of such use and will agree to hold Diodes Incorporated and all the companies whose products are represented on Diodes Incorporated website, harmless against all damages.

Diodes Incorporated does not warrant or accept any liability whatsoever in respect of any products purchased through unauthorized sales channel. Should Customers purchase or use Diodes Incorporated products for any unintended or unauthorized application, Customers shall indemnify and hold Diodes Incorporated and its representatives harmless against all claims, damages, expenses, and attorney fees arising out of, directly or indirectly, any claim of personal injury or death associated with such unintended or unauthorized application.

Products described herein may be covered by one or more United States, international or foreign patents pending. Product names and markings noted herein may also be covered by one or more United States, international or foreign trademarks.

**LIFE SUPPORT**

Diodes Incorporated products are specifically not authorized for use as critical components in life support devices or systems without the express written approval of the Chief Executive Officer of Diodes Incorporated. As used herein:

A. Life support devices or systems are devices or systems which:

1. are intended to implant into the body, or
2. support or sustain life and whose failure to perform when properly used in accordance with instructions for use provided in the labeling can be reasonably expected to result in significant injury to the user.

B. A critical component is any component in a life support device or system whose failure to perform can be reasonably expected to cause the failure of the life support device or to affect its safety or effectiveness.

Customers represent that they have all necessary expertise in the safety and regulatory ramifications of their life support devices or systems, and acknowledge and agree that they are solely responsible for all legal, regulatory and safety-related requirements concerning their products and any use of Diodes Incorporated products in such safety-critical, life support devices or systems, notwithstanding any devices- or systems-related information or support that may be provided by Diodes Incorporated. Further, Customers must fully indemnify Diodes Incorporated and its representatives against any damages arising out of the use of Diodes Incorporated products in such safety-critical, life support devices or systems.

Copyright © 2010, Diodes Incorporated

[www.diodes.com](http://www.diodes.com)