

PLEASE CHECK WWW.MOLEX.COM FOR LATEST PART INFORMATION

Part Number: [0877594064](#)
Status: **Active**
Overview: milligrid
Description: 2.00mm (.079") Pitch Milli-Grid™ Header, Surface Mount, Vertical, 40 Circuits, 0.38µm (15µ") Gold (Au) Selective Plating, without Press-fit Plastic Pegs, Pick-and-Place Cap, Tube Packaging, Lead-free

Documents:

[3D Model](#) [Product Specification PS-87761-100 \(PDF\)](#)
[Drawing \(PDF\)](#) [RoHS Certificate of Compliance \(PDF\)](#)

Agency Certification

UL E29179

General

Product Family PCB Headers
 Series [87759](#)
 Application Board-to-Board
 Overview [milligrid](#)
 Product Name Milli-Grid™

Physical

Breakaway Yes
 Circuits (Loaded) 40
 Circuits (maximum) 40
 Color - Resin Black
 Durability (mating cycles max) 100
 First Mate / Last Break No
 Flammability 94V-0
 Glow-Wire Compliant No
 Guide to Mating Part No
 Keying to Mating Part None
 Lock to Mating Part None
 Mated Height (in) 0.150 In
 Mated Height (mm) 3.80 mm
 Material - Metal Phosphor Bronze
 Material - Plating Mating Gold
 Material - Plating Termination Tin
 Material - Resin Nylon
 Number of Rows 2
 Orientation Vertical
 PCB Locator No
 PCB Retention None
 Packaging Type Tube
 Pitch - Mating Interface (in) 0.079 In
 Pitch - Mating Interface (mm) 2.00 mm
 Pitch - Term. Interface (in) 0.079 In
 Pitch - Term. Interface (mm) 2.00 mm
 Plating min: Mating (µin) 15
 Plating min: Mating (µm) 0.38
 Polarized to Mating Part No
 Polarized to PCB No
 Robotic Placement Pick and Place Cap
 Shrouded No
 Stackable No
 Temperature Range - Operating -55°C to +105°C

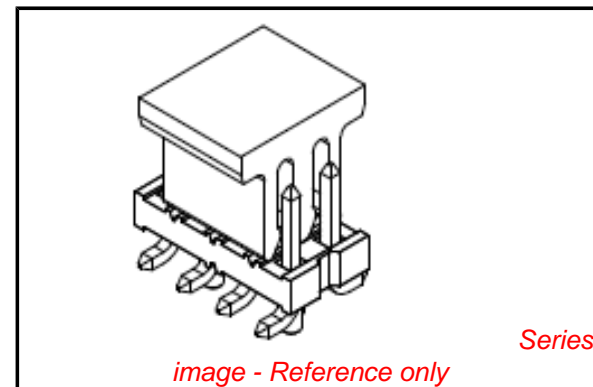

image - Reference only

EU RoHS

ELV and RoHS Compliant
REACH SVHC Contains SVHC: No
Halogen-Free Status
Not Reviewed

China RoHS



Need more information on product environmental compliance?

Email productcompliance@molex.com
 For a multiple part number RoHS Certificate of Compliance, [click here](#)

Please visit the [Contact Us](#) section for any non-product compliance questions.

Search Parts in this Series

[87759Series](#)

Mates With

[79107](#) Milli-Grid™ Receptacle, Vertical, Through Hole. [79108](#) Milli-Grid™ Flex-to-Board, Vertical Receptacle. Milli-Grid™ Receptacle, Surface Mount. [79109](#). [87381](#)

Termination Interface: Style Surface Mount

Electrical

Current - Maximum per Contact 2A
Voltage - Maximum 125V

Material Info

Reference - Drawing Numbers

Packaging Specification PK-89990-476
Product Specification PS-87761-100
Sales Drawing SD-87759-117

This document was generated on 05/25/2010

PLEASE CHECK WWW.MOLEX.COM FOR LATEST PART INFORMATION

F

E

D

C

B

A

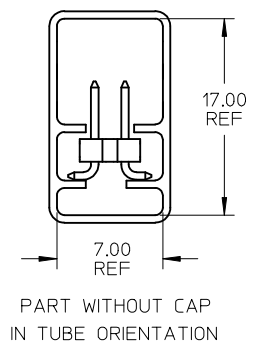
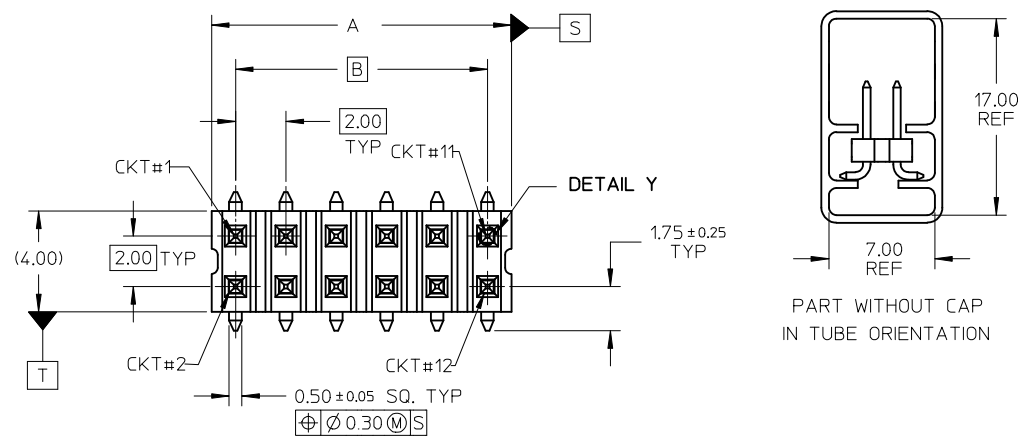

- NOTE:
- MATERIAL:
HSG & CAP - NYLON, GLASS FILLED
UL 94V-0, COLOUR BLACK

PIN - 0.50 SQ PHOSPHOR BRONZE
 - PLATING:
0.38um MIN GOLD PLATE AT CONTACT AREA,
TIN PLATE AT SOLDER AREA,
BOTH OVER NICKEL UNDERPLATE
 - PIN PUSHOUT FORCE: 1KG MIN IN EITHER DIRECTION
 - PRODUCT SPEC PS-87761-100 APPLIES.
 - BEND DEPRESSION IS ACCEPTABLE SO LONG AS IT DOES NOT AFFECT THE OVERALL COPLANARITY OF TAIL.
 - COPLANARITY IS TO BE MEASURED BY RESTING THE SOLDER TAIL ON A FLAT SURFACE.
 - CAP TO BE LOCATED AS CENTRAL OF PART AS POSSIBLE
TOP SURFACE OF CAP TO BE FLAT FOR THE PURPOSE OF PICK & PLACE BY VACUUM SUCTION NOZZLE.
 - FOR ILLUSTRATION PURPOSES, 12CKT IS SHOWN.
 - CKT 4 & 6 IS CUT FROM CKT 8 & 12 RESPECTIVELY
ROUGH EDGES ARE EXPECTED ALONG THE CUTTING EDGES.
 - PART TO BE PACKED IN TRAY ONLY.
 - TUBE LENGTH IS 560MM REF STANDARD.

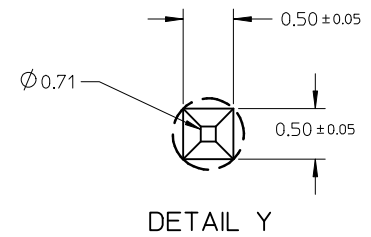
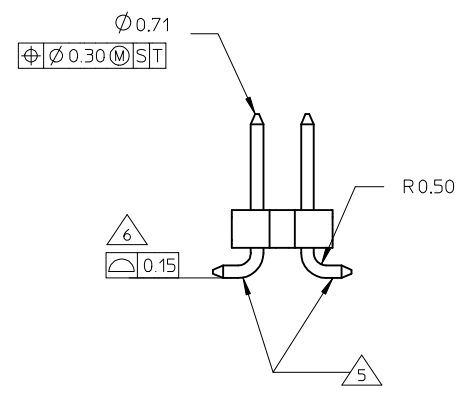
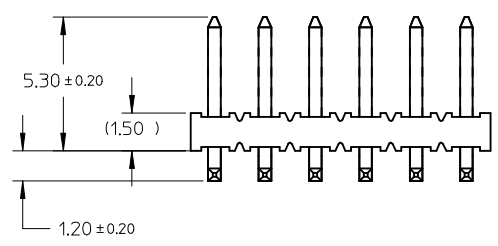

| | | | | | | | | | | |
|---|-----------------|--|-------|---|------------|--------------------------|---------------|------------------------|--|--|
| ADD. OPTION EC NO: S2009-0510 DRW: NAI SEE CHKD: SKANG APPR: M LONG 2009/01/23 2009/02/09 2009/02/17 | QUALITY SYMBOLS | GENERAL TOLERANCES (UNLESS SPECIFIED) | | DIMENSION STYLE | | SCALE | DESIGN UNITS | THIRD ANGLE PROJECTION | | |
| | ▽=0 □=0 | mm | INCH | MM ONLY | | NTS | METRIC | | | |
| | | 4 PLACES | ± --- | ± --- | DRAWN BY | DATE | TITLE | | | |
| | | 3 PLACES | ± --- | ± --- | KSEE | 2003/12/12 | CUSTOM HEADER | | | |
| | 2 PLACES | ± 0.2 | ± --- | CHECKED BY | DATE | MGRID, 2MM DUAL ROW HDR. | | | | |
| | 1 PLACE | ± --- | ± --- | KCL ING | 2004/01/12 | SMT | | | | |
| | | ANGULAR ± 3 ° | | APPROVED BY | DATE | MOLEX INCORPORATED | | | | |
| | | DRAFT WHERE APPLICABLE MUST REMAIN WITHIN DIMENSIONS | | SKTOH | 2004/01/12 | DOCUMENT NO. | | SHEET NO. | | |
| | | | | SEE TABLE | | SD-87759-117 | | 1 OF 6 | | |
| | | | | THIS DRAWING CONTAINS INFORMATION THAT IS PROPRIETARY TO MOLEX INCORPORATED AND SHOULD NOT BE USED WITHOUT WRITTEN PERMISSION | | | | | | |

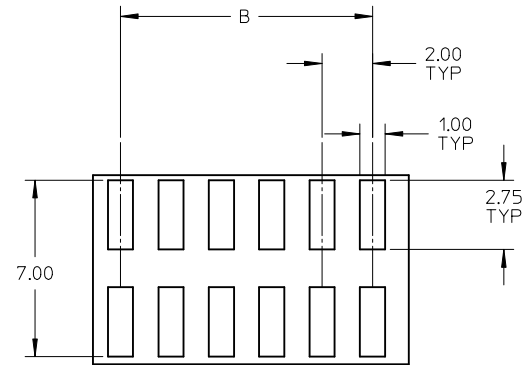
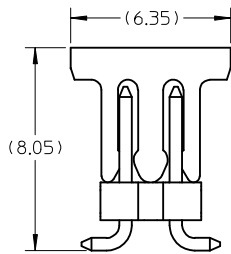

RECOMMENDED SOLDER PAD LAYOUT

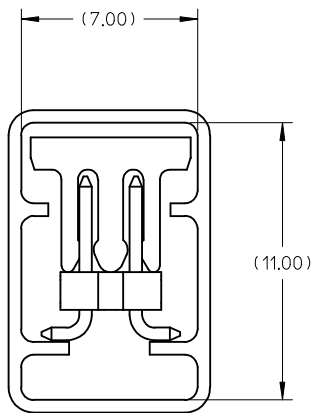

| | | | | | | | | |
|--|---|--|---|---|------------------------|------------------------|--|--|
| ADD. OPTION EC NO: S2009-0510 DRWN:ATSEE 2009/01/23 CHKD:SKANG 2009/02/09 APPR:MLONG 2009/02/17 | QUALITY SYMBOLS ▽=0 ◻=0 | GENERAL TOLERANCES (UNLESS SPECIFIED) mm INCH | DIMENSION STYLE MM ONLY | SCALE NTS | DESIGN UNITS METRIC | THIRD ANGLE PROJECTION | | |
| | 4 PLACES ± --- ± --- 3 PLACES ± --- ± --- 2 PLACES ± 0.2 ± --- 1 PLACE ± --- ± --- | DRAWN BY DATE KSEE 2003/12/12 CHECKED BY DATE KCLING 2004/01/12 APPROVED BY DATE SKTOH 2004/01/12 | TITLE CUSTOM HEADER MGRID, 2MM DUAL ROW HDR. SMT | | | | | |
| | ANGULAR ± 3 ° | MATERIAL NO. | MOLEX INCORPORATED | | | | | |
| | DRAFT WHERE APPLICABLE MUST REMAIN WITHIN DIMENSIONS | SEE TABLE | DOCUMENT NO. | SD-87759-117 | | | | |
| B2 | REV DESCRIPTION | SIZE A3 | | THIS DRAWING CONTAINS INFORMATION THAT IS PROPRIETARY TO MOLEX INCORPORATED AND SHOULD NOT BE USED WITHOUT WRITTEN PERMISSION | | | | |

EMBOSSED CARRIER TAPE TYPE "A"

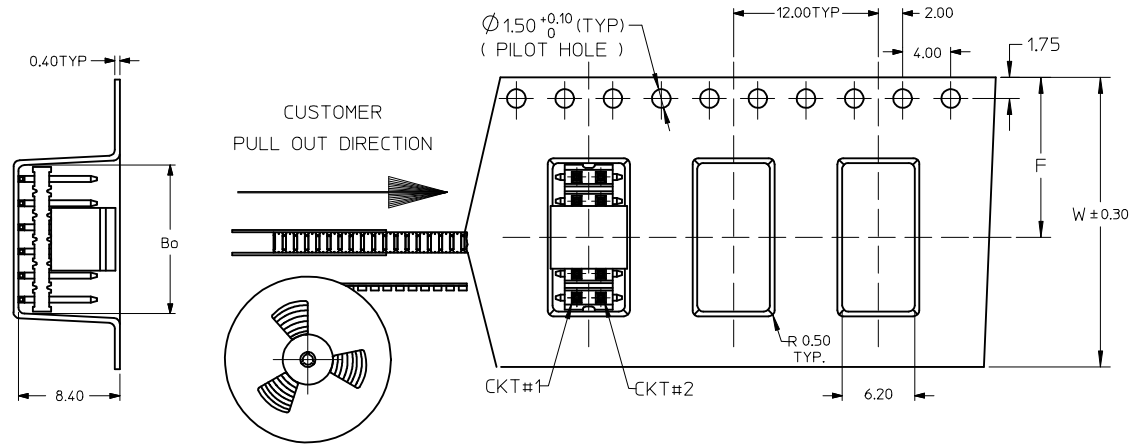

NOTES:

12. LEADER AND TRAILER TAPE



13. PEELING OFF FORCE OF THE TOP TAPE: 20-80gf.
(PEELING DIRECTION AS SHOWN IN FOLLOWING FIGURE)

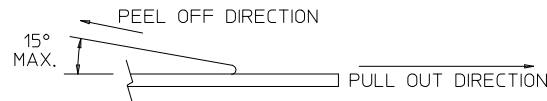

14. PACKAGING STANDARD IS AS PER EIA-481.

15. TAPE & REEL QUANTITY = 750 PCS/REEL

16. THE TAPE IS TREATED FOR ANTI-STATIC

| | | | | | | |
|---|--|---|---|---|--|--|
| ADD. OPTION EC NO: S2009-0510 DRWN:ATSEE 2009/01/23 CHKD:SKANG 2009/02/09 APPR:MLONG 2009/02/17 REV B2 | QUALITY SYMBOLS ▽=0 ▽=0 | GENERAL TOLERANCES (UNLESS SPECIFIED) mm INCH 4 PLACES ± --- ± --- 3 PLACES ± --- ± --- 2 PLACES ± 0.2 ± --- 1 PLACE ± --- ± --- ANGULAR ± 3° | DIMENSION STYLE MM ONLY DRAWN BY: KSEE DATE: 2003/12/12 CHECKED BY: KCLING DATE: 2004/01/12 APPROVED BY: SKTOH DATE: 2004/01/12 | SCALE: NTS DESIGN UNITS: METRIC THIRD ANGLE PROJECTION | TITLE: CUSTOM HEADER MGRID, 2MM DUAL ROW HDR. SMT MOLEX INCORPORATED DOCUMENT NO. SD-87759-117 SHEET NO. 3 OF 6 | |
| | DRAFT WHERE APPLICABLE MUST REMAIN WITHIN DIMENSIONS | | SEE TABLE | THIS DRAWING CONTAINS INFORMATION THAT IS PROPRIETARY TO MOLEX INCORPORATED AND SHOULD NOT BE USED WITHOUT WRITTEN PERMISSION | | |
| | | | | | | |
| | | | | | | |

EMBOSSED CARRIER TAPE TYPE "B"

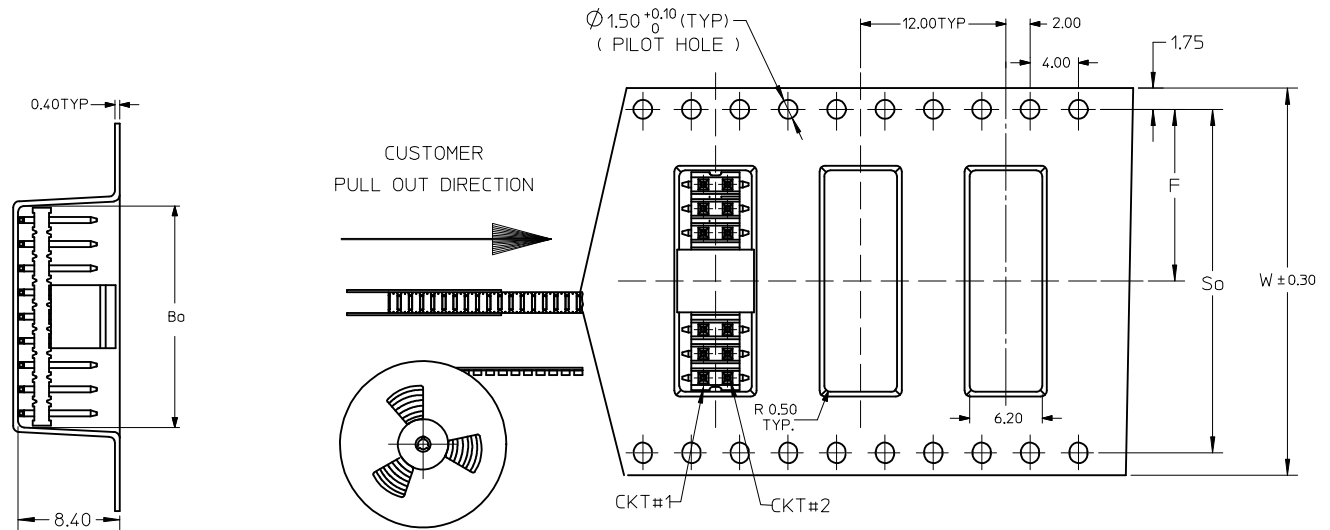

| | | | | | |
|---|---|--|--|--|---|
| ADD. OPTION EC NO: S2009-0510 DRWN:ATSEE 2009/01/23 CHKD:SKANG 2009/02/09 APPR:MLONG 2009/02/17 | QUALITY SYMBOLS ▽=0 ◻=0 | GENERAL TOLERANCES (UNLESS SPECIFIED) mm INCH 4 PLACES ± --- ± --- 3 PLACES ± --- ± --- 2 PLACES ± 0.2 ± --- 1 PLACE ± --- ± --- ANGULAR ± 3 ° | DIMENSION STYLE MM ONLY DRAWN BY DATE KSEE 2003/12/12 CHECKED BY DATE KCLING 2004/01/12 APPROVED BY DATE SKTOH 2004/01/12 | SCALE NTS DESIGN UNITS METRIC THIRD ANGLE PROJECTION | TITLE CUSTOM HEADER MGRID, 2MM DUAL ROW HDR. SMT |
| | DESCRIPTION B2 | DRAFT WHERE APPLICABLE MUST REMAIN WITHIN DIMENSIONS | MATERIAL NO. SEE TABLE | MOLEX INCORPORATED DOCUMENT NO. SD-87759-117 | SHEET NO. 4 OF 6 |
| | THIS DRAWING CONTAINS INFORMATION THAT IS PROPRIETARY TO MOLEX INCORPORATED AND SHOULD NOT BE USED WITHOUT WRITTEN PERMISSION | | | | |
| | SIZE A3 | | | | |

THIS TYPE OF CARRIER IS FOR CKT SIZE 8 AND BELOW.



| | | | | | | | | | | | |
|--|--------------------|--|---------------------------------------|------------|-----------------------------------|--|---|------------------------|------------------------|--|--|
| ADD. OPTION EC NO: S2009-0510 DRWN:ATSEE 2009/01/23 CHKD:SKANG 2009/02/09 APPR:MLONG 2009/02/17 | DESCRIPTION REV | QUALITY SYMBOLS ▽=0 ◻=0 | GENERAL TOLERANCES (UNLESS SPECIFIED) | | DIMENSION STYLE MM ONLY | | SCALE NTS | DESIGN UNITS METRIC | THIRD ANGLE PROJECTION | | |
| | | | mm | INCH | DRAWN BY | DATE | TITLE | | | | |
| | | 4 PLACES | ± --- | ± --- | KSEE | 2003/12/12 | CUSTOM HEADER MGRID, 2MM DUAL ROW HDR. SMT | | | | |
| | | 3 PLACES | ± --- | ± --- | CHECKED BY | DATE | | | | | |
| 2 PLACES | ± 0.2 | ± --- | KCLING | 2004/01/12 | MOLEX INCORPORATED | | | | | | |
| 1 PLACE | ± --- | ± --- | APPROVED BY | DATE | | | | | | | |
| | | | ANGULAR ± 3 ° | | SKTOH | 2004/01/12 | MATERIAL NO. | | DOCUMENT NO. | | |
| | | DRAFT WHERE APPLICABLE MUST REMAIN WITHIN DIMENSIONS | | | SEE TABLE | | SD-87759-117 | | SHEET NO. 5 OF 6 | | |
| | | | | | SIZE | THIS DRAWING CONTAINS INFORMATION THAT IS PROPRIETARY TO MOLEX INCORPORATED AND SHOULD NOT BE USED WITHOUT WRITTEN PERMISSION | | | | | |

| | 10 | 9 | 8 | 7 | 6 | 5 | 4 | 3 | 2 | 1 | | |
|---|---|------------------------------|--|----------|-----------|-------|-------|-------|-------|-------|-------|---------------|
| | PART NUMBER WITHOUT CAP IN TUBE | PART NUMBER WITH CAP IN TUBE | PART NUMBER WITH CAP IN TAPE AND REEL. | CKT SIZE | VOID CKTS | A | B | Bo | F | So | W | EMBOSSED TYPE |
| F | 87759-0414 $\triangle_9 \triangle_{10}$ | 87759-0464 | 87759-0474 | 4 | -- | NA | 2.00 | 5.40 | 11.50 | - | 24.00 | C |
| | 87759-0614 \triangle_9 | 87759-0664 | 87759-0674 | 6 | -- | NA | 4.00 | 7.20 | 11.50 | - | 24.00 | C |
| | 87759-0814 | 87759-0864 | 87759-0874 | 8 | -- | 7.90 | 6.00 | 8.20 | 11.50 | - | 24.00 | C |
| | 87759-1014 | 87759-1064 | 87759-1074 | 10 | -- | 9.90 | 8.00 | 10.20 | 11.50 | - | 24.00 | A |
| | 87759-1002 \triangle_A | 87759-1003 \triangle_A | 87759-1004 \triangle_A | 10 | 10 | 9.90 | 8.00 | 10.20 | 11.50 | - | 24.00 | A |
| | 87759-1214 | 87759-1264 | 87759-1274 | 12 | -- | 11.90 | 10.00 | 12.20 | 11.50 | - | 24.00 | A |
| E | 87759-1414 | 87759-1464 | 87759-1474 | 14 | -- | 13.90 | 12.00 | 14.20 | 11.50 | - | 24.00 | A |
| | 87759-1614 | 87759-1664 | 87759-1674 | 16 | -- | 15.90 | 14.00 | 16.20 | 14.20 | 28.40 | 32.00 | B |
| | 87759-1814 | 87759-1864 | 87759-1874 | 18 | -- | 17.90 | 16.00 | 18.20 | 14.20 | 28.40 | 32.00 | B |
| | 87759-2014 | 87759-2064 | 87759-2074 | 20 | -- | 19.90 | 18.00 | 20.20 | 14.20 | 28.40 | 32.00 | B |
| | 87759-2214 | 87759-2264 | 87759-2274 | 22 | -- | 21.90 | 20.00 | 22.20 | 20.20 | 40.40 | 44.00 | B |
| D | 87759-2414 | 87759-2464 | 87759-2474 | 24 | -- | 23.90 | 22.00 | 24.20 | 20.20 | 40.40 | 44.00 | B |
| | 87759-2614 | 87759-2664 | 87759-2674 | 26 | -- | 25.90 | 24.00 | 26.20 | 20.20 | 40.40 | 44.00 | B |
| | 87759-2814 | 87759-2864 | 87759-2874 | 28 | -- | 27.90 | 26.00 | 28.20 | 20.20 | 40.40 | 44.00 | B |
| | 87759-3014 | 87759-3064 | 87759-3074 | 30 | -- | 29.90 | 28.00 | 30.20 | 20.20 | 40.40 | 44.00 | B |
| | 87759-3214 | 87759-3264 | 87759-3274 | 32 | -- | 31.90 | 30.00 | 32.20 | 20.20 | 40.40 | 44.00 | B |
| | 87759-3414 | 87759-3464 | 87759-3474 | 34 | -- | 33.90 | 32.00 | 34.20 | 26.20 | 52.40 | 56.00 | B |
| | 87759-3614 | 87759-3664 | 87759-3674 | 36 | -- | 35.90 | 34.00 | 36.20 | 26.20 | 52.40 | 56.00 | B |
| C | 87759-3814 | 87759-3864 | 87759-3874 | 38 | -- | 37.90 | 36.00 | 38.20 | 26.20 | 52.40 | 56.00 | B |
| | 87759-4014 | 87759-4064 | 87759-4074 | 40 | -- | 39.90 | 38.00 | 40.20 | 26.20 | 52.40 | 56.00 | B |
| | 87759-4214 | 87759-4264 | 87759-4274 | 42 | -- | 41.90 | 40.00 | 42.20 | 26.20 | 52.40 | 56.00 | B |
| | 87759-4414 | 87759-4464 | 87759-4474 | 44 | -- | 43.90 | 42.00 | 44.20 | 26.20 | 52.40 | 56.00 | B |
| | 87759-4614 | 87759-4664 | 87759-4674 | 46 | -- | 45.90 | 44.00 | 46.20 | 26.20 | 52.40 | 56.00 | B |
| | 87759-4814 | 87759-4864 | 87759-4874 | 48 | -- | 47.90 | 46.00 | 48.20 | 26.20 | 52.40 | 56.00 | B |
| B | 87759-5014 | 87759-5064 | 87759-5074 | 50 | -- | 49.90 | 48.00 | 50.20 | 34.20 | 68.40 | 72.00 | B |

NOTES:
 \triangle_A VOIDED PIN CKT#10 FOR PART#87759-1002

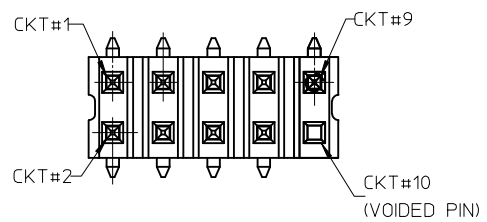

| ADD. OPTION EC NO: S2009-0510 DRWN:ATSEE 2009/01/23 CHKD:SKANG 2009/02/09 APPR:MLONG 2009/02/17 B2 | QUALITY SYMBOLS $\nabla=0$ $\triangle=0$ | GENERAL TOLERANCES (UNLESS SPECIFIED) <table border="1"> <tr> <th></th> <th>mm</th> <th>INCH</th> </tr> <tr> <td>4 PLACES</td> <td>\pm ---</td> <td>\pm ---</td> </tr> <tr> <td>3 PLACES</td> <td>\pm ---</td> <td>\pm ---</td> </tr> <tr> <td>2 PLACES</td> <td>\pm 0.2</td> <td>\pm ---</td> </tr> <tr> <td>1 PLACE</td> <td>\pm ---</td> <td>\pm ---</td> </tr> </table> | | mm | INCH | 4 PLACES | \pm --- | \pm --- | 3 PLACES | \pm --- | \pm --- | 2 PLACES | \pm 0.2 | \pm --- | 1 PLACE | \pm --- | \pm --- | DIMENSION STYLE MM ONLY DRAWN BY: KSEE DATE: 2003/12/12 CHECKED BY: KCLING DATE: 2004/01/12 APPROVED BY: SKTOH DATE: 2004/01/12 MATERIAL NO. | SCALE NTS DESIGN UNITS METRIC THIRD ANGLE PROJECTION | TITLE CUSTOM HEADER MGRID, 2MM DUAL ROW HDR. SMT MOLEX INCORPORATED DOCUMENT NO. SD-87759-117 | SHEET NO. 6 OF 6 |
|---|---|---|----------|-----------|-----------|----------|-----------|-----------|----------|-----------|-----------|----------|-----------|-----------|---------|-----------|-----------|---|---|--|---------------------|
| | | | | mm | INCH | | | | | | | | | | | | | | | | |
| | | | 4 PLACES | \pm --- | \pm --- | | | | | | | | | | | | | | | | |
| | | | 3 PLACES | \pm --- | \pm --- | | | | | | | | | | | | | | | | |
| 2 PLACES | \pm 0.2 | \pm --- | | | | | | | | | | | | | | | | | | | |
| 1 PLACE | \pm --- | \pm --- | | | | | | | | | | | | | | | | | | | |
| DRAFT WHERE APPLICABLE MUST REMAIN WITHIN DIMENSIONS | SEE TABLE | THIS DRAWING CONTAINS INFORMATION THAT IS PROPRIETARY TO MOLEX INCORPORATED AND SHOULD NOT BE USED WITHOUT WRITTEN PERMISSION | | | | | | | | | | | | | | | | | | | |
| | SIZE A3 | | | | | | | | | | | | | | | | | | | | |
| | | | | | | | | | | | | | | | | | | | | | |