

## Features

1. Compact dual-in-line package.
2. 600V peak blocking voltage.
3. Isolation voltage between input and output (Viso:5000Vrms).

## For 115/240 Vac (rms) Application:

1. Solenoid/Valve Controls.
2. Lighting Controls.
3. Static Power Switches.
4. AC Motor Drives.
5. Temperature Controls.
6. E. M. Contactors.
7. AC Motor Staters.
8. Solid State Relays.
9. Programmable controllers.

## Outside Dimension:Unit (mm)

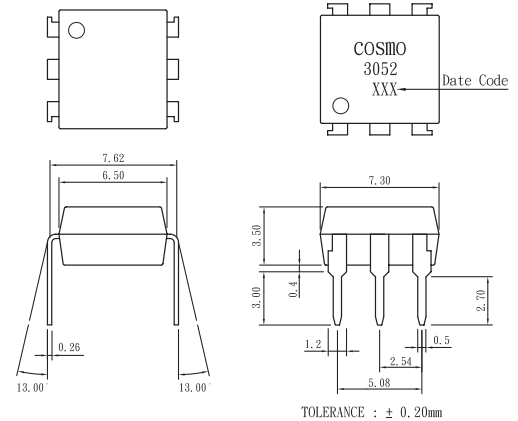

## Schematic:Top View

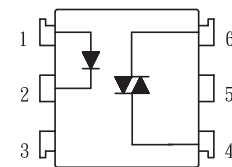

1. Anode
2. Cathode
3. NC
4. MAIN TERMINAL
5. SUBSTRATE DO NOT CONNECT
6. MAIN TERMINAL

## Absolute Maximum Ratings

(Ta=25°C)

Parameter	Symbol	Rating	Unit
Input	Forward current	IF	50 mA
	Peak forward current (100us)	IFM	1 A
	Reverse voltage	VR	6 V
	Power dissipation	PD	70 mW
Output	Off-State Output Terminal voltage	VDRM	600 Vpeak
	On-State R. M. S. Current	IT(RMS)	100 mA
	Peak Repetitive Surget Current (PW=10ms, DC 10%)	ITSM	6 A
	Power dissipation	PD	300 mW
Total power dissipation	Ptot	330 mW	
Isolation voltage 1 minute	Viso	5000 Vrms	
Operating temperature	Topr	-40 to +85 °C	
Storage temperature	Tstg	-50 to +125 °C	
Soldering temperature 10 second	Tsol	260 °C	

## Electro-optical Characteristics

(Ta=25°C)

Parameter	Symbol	Conditions	MIN.	TYP.	MAX.	Unit
Input	Forward voltage	IF=10mA		1.2	1.4	V
	Peak forward voltage	IFM=0.5A			3.5	V
	Reverse Leakage Current	VR=4V			10	μA
Output	Peak Blocking Current	VDRM=600V			100	nA
	ON-State Voltage	ITM=100mA		1.6	2.8	V
Transfer characteristics	Holding Current			1.0		mA
	Critical rate of rise of OFF-state voltage	VDRM= (1/ 2) *Rated	600			V/ μS
	Isolation resistance	DC500V	5x10 <sup>10</sup>	10 <sup>11</sup>		ohm
	Minimum trigger current	Main Terminal Voltage=3V			10	mA
	Turn-on time	VD=6V, RL=100 ohm, IF=20mA			100	μS

**Fig.1 Forward Current vs. Ambient Temperature**

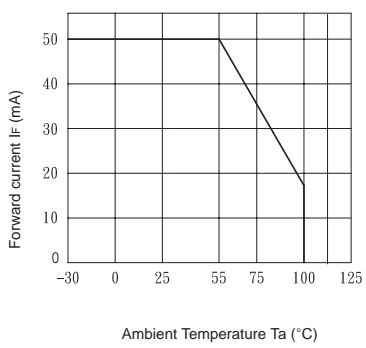

**Fig.2 Diode Power Dissipation vs. Ambient Temperature**

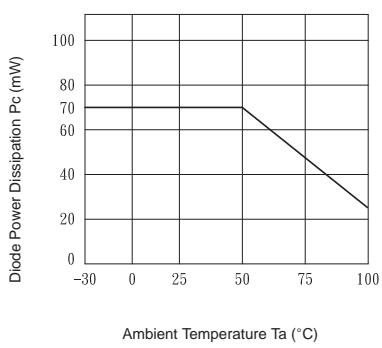

**Fig.3 On-State R. M. S. Current vs. Ambient Temperature**

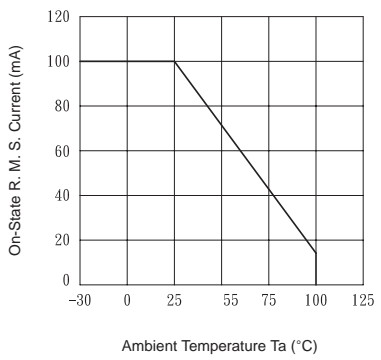

**Fig.4 Total Power Dissipation vs. Ambient Temperature**

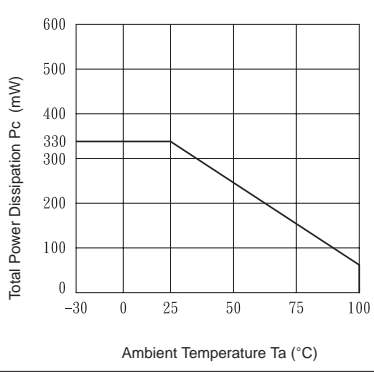

**Fig.5 Peak Forward Current vs. Duty Ratio**

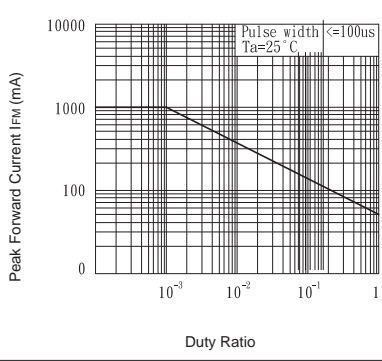

**Fig.6 Forward Current vs. Forward Voltage**

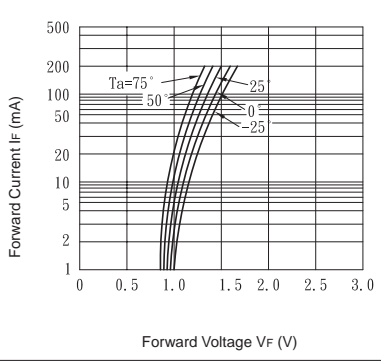

**Fig.7 On-State Characteristics**

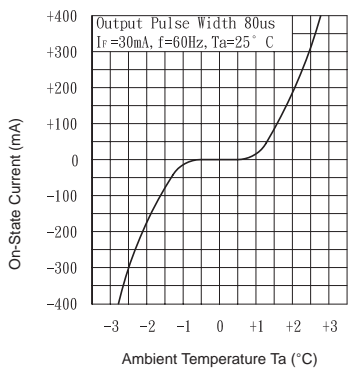

**Fig.8 Leakage with LED off vs. Ambient Temperature**

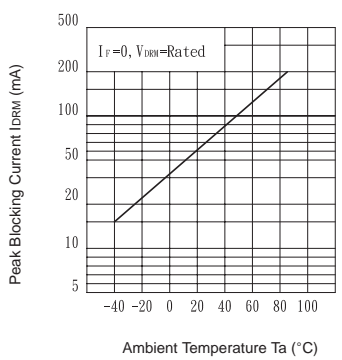

**Fig.9 Trigger Current vs. Ambient Temperature**

