

FEATURES

Isolated high-side and low-side outputs

High side or low side relative to input: $\pm 700 V_{PEAK}$

High-side/low-side differential: $700 V_{PEAK}$

0.1 A peak output current

CMOS input threshold levels

High frequency operation: 5 MHz maximum

High common-mode transient immunity: $>75 \text{ kV}/\mu\text{s}$

High temperature operation: 105°C

Wide body, RoHS compliant, 16-lead SOIC

UL1577 2500 V rms input-to-output withstand voltage

APPLICATIONS

Isolated IGBT/MOSFET gate drives

Plasma displays

Industrial inverters

Switching power supplies

GENERAL DESCRIPTION

The ADuM1234¹ is an isolated, half-bridge gate driver that employs the Analog Devices, Inc. *iCoupler*[®] technology to provide independent and isolated high-side and low-side outputs. Combining high speed CMOS and monolithic transformer technology, this isolation component provides outstanding performance characteristics superior to optocoupler-based solutions.

By avoiding the use of LEDs and photodiodes, this *iCoupler* gate drive device is able to provide precision timing characteristics not possible with optocouplers. Furthermore, the reliability and performance stability problems associated with optocoupler LEDs are avoided.

In comparison to gate drivers employing high voltage level translation methodologies, the ADuM1234 offers the benefit of true, galvanic isolation between the input and each output. Each output can be operated up to $\pm 700 V_{PEAK}$ relative to the input, thereby supporting low-side switching to negative voltages. The differential voltage between the high side and low side can be as high as $700 V_{PEAK}$.

As a result, the ADuM1234 provides reliable control over the switching characteristics of IGBT/MOSFET configurations over a wide range of positive or negative switching voltages.

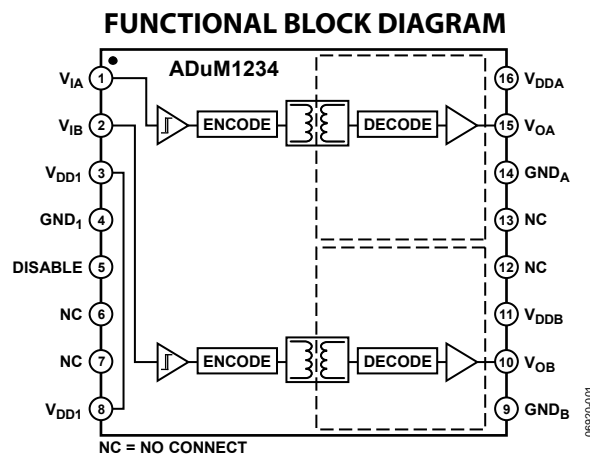

Figure 1.

¹ Protected by U.S. Patents 5,952,849; 6,873,065; 7,075,329. Other patents pending.

Rev. 0

Information furnished by Analog Devices is believed to be accurate and reliable. However, no responsibility is assumed by Analog Devices for its use, nor for any infringements of patents or other rights of third parties that may result from its use. Specifications subject to change without notice. No license is granted by implication or otherwise under any patent or patent rights of Analog Devices. Trademarks and registered trademarks are the property of their respective owners.

ADuM1234

TABLE OF CONTENTS

Features	1	Recommended Operating Conditions	4
Applications.....	1	Absolute Maximum Ratings	5
General Description	1	ESD Caution.....	5
Functional Block Diagram	1	Pin Configuration and Function Descriptions.....	6
Revision History	2	Typical Performance Characteristics.....	7
Specifications.....	3	Application Notes	8
Electrical Characteristics.....	3	Common-Mode Transient Immunity	8
Package Characteristics	4	Insulation Lifetime.....	9
Regulatory Information.....	4	Outline Dimensions	10
Insulation and Safety-Related Specifications.....	4	Ordering Guide	10

REVISION HISTORY

7/07—Revision 0: Initial Version

SPECIFICATIONS

ELECTRICAL CHARACTERISTICS

$4.5\text{ V} \leq V_{DD1} \leq 5.5\text{ V}$, $12\text{ V} \leq V_{DDA} \leq 18\text{ V}$, $12\text{ V} \leq V_{DDB} \leq 18\text{ V}$. All minimum/maximum specifications apply over the entire recommended operating range, unless otherwise noted. All typical specifications are at $T_A = 25^\circ\text{C}$, $V_{DD1} = 5\text{ V}$, $V_{DDA} = 15\text{ V}$, $V_{DDB} = 15\text{ V}$. All voltages are relative to their respective grounds.

Table 1.

Parameter	Symbol	Min	Typ	Max	Unit	Test Conditions
DC SPECIFICATIONS						
Input Supply Current, Quiescent	$I_{DDI(Q)}$		3.0	4.2	mA	
Output Supply Current A or Output Supply Current B, Quiescent	$I_{DDA(Q)}$, $I_{DDB(Q)}$		0.3	1.2	mA	
Input Supply Current, 10 Mbps	$I_{DDI(10)}$		6.0	9.0	mA	
Output Supply Current A or Output Supply Current B, 10 Mbps	$I_{DDA(10)}$, $I_{DDB(10)}$		16	22	mA	$C_L = 200\text{ pF}$
Input Currents	I_{IA} , I_{IB} , $I_{DISABLE}$	-10	+0.01	+10	μA	$0\text{ V} \leq V_{IA}, V_{IB}, V_{DISABLE} \leq V_{DD1}$
Logic High Input Threshold	V_{IH}	$0.7 \times V_{DD1}$			V	
Logic Low Input Threshold	V_{IL}			$0.3 \times V_{DD1}$	V	
Logic High Output Voltages	V_{OAH}, V_{OBH}	$V_{DDA} - 0.1$, $V_{DDB} - 0.1$	V_{DDA}, V_{DDB}		V	$I_{OA}, I_{OB} = -1\text{ mA}$
Logic Low Output Voltages	V_{OAL}, V_{OBL}			0.1	V	$I_{OA}, I_{OB} = +1\text{ mA}$
Output Short-Circuit Pulsed Current ¹	$I_{OA(SC)}, I_{OB(SC)}$	100			mA	
SWITCHING SPECIFICATIONS						
Minimum Pulse Width ²	PW			100	ns	$C_L = 200\text{ pF}$
Maximum Switching Frequency ³		10			Mbps	$C_L = 200\text{ pF}$
Propagation Delay ⁴	t_{PHL}, t_{PLH}	97	124	160	ns	$C_L = 200\text{ pF}$
Change vs. Temperature			100		ps/ $^\circ\text{C}$	$C_L = 200\text{ pF}$
Pulse Width Distortion, $ t_{PLH} - t_{PHL} $	PWD			8	ns	$C_L = 200\text{ pF}$
Channel-to-Channel Matching, Rising or Falling Edges ⁵				5	ns	$C_L = 200\text{ pF}$
Channel-to-Channel Matching, Rising vs. Falling Edges ⁶				13	ns	$C_L = 200\text{ pF}$
Part-to-Part Matching, Rising or Falling Edges ⁷				55	ns	$C_L = 200\text{ pF}$, Input $t_r = 3\text{ ns}$
Part-to-Part Matching, Rising vs. Falling Edges ⁸				63	ns	$C_L = 200\text{ pF}$, Input $t_r = 3\text{ ns}$
Output Rise/Fall Time (10% to 90%)	t_R/t_F			25	ns	$C_L = 200\text{ pF}$

¹ Short-circuit duration less than 1 second.

² The minimum pulse width is the shortest pulse width at which the specified timing parameters are guaranteed.

³ The maximum switching frequency is the maximum signal frequency at which the specified timing parameters are guaranteed.

⁴ t_{PHL} propagation delay is measured from the 50% level of the falling edge of the V_{ix} signal to the 50% level of the falling edge of the V_{Ox} signal. t_{PLH} propagation delay is measured from the 50% level of the rising edge of the V_{ix} signal to the 50% level of the rising edge of the V_{Ox} signal.

⁵ Channel-to-channel matching, rising or falling edges, is the magnitude of the propagation delay difference between two channels of the same part when the inputs are either both rising or falling edges. The supply voltages and the loads on each channel are equal.

⁶ Channel-to-channel matching, rising vs. falling edges, is the magnitude of the propagation delay difference between two channels of the same part when one input is a rising edge and the other input is a falling edge. The supply voltages and loads on each channel are equal.

⁷ Part-to-part matching, rising or falling edges, is the magnitude of the propagation delay difference between the same channels of two different parts when the inputs are either both rising or falling edges. The supply voltages, temperatures, and loads of each part are equal.

⁸ Part-to-part matching, rising vs. falling edges, is the magnitude of the propagation delay difference between the same channels of two different parts when one input is a rising edge and the other input is a falling edge. The supply voltages, temperatures, and loads of each part are equal.

ADuM1234

PACKAGE CHARACTERISTICS

Table 2.

Parameter	Symbol	Min	Typ	Max	Unit	Test Conditions
Resistance (Input-to-Output) ¹	R _{I-O}		10 ¹²		Ω	f = 1 MHz
Capacitance (Input-to-Output) ¹	C _{I-O}		2.0		pF	
Input Capacitance	C _I		4.0		pF	
IC Junction-to-Ambient Thermal Resistance	θ _{JA}		76		°C/W	

¹ The device is considered a 2-terminal device: Pin 1 through Pin 8 are shorted together, and Pin 9 through Pin 16 are shorted together.

REGULATORY INFORMATION

The ADuM1234 has been approved by the organization listed in Table 3. Refer to Table 7 and the Insulation Lifetime section for details regarding recommended maximum working voltages for specific cross-isolation waveforms and insulation levels.

Table 3.

UL
Recognized under the 1577 component recognition program ¹
Single/basic insulation, 2500 V rms isolation voltage

¹ In accordance with UL1577, each ADuM1234 is proof tested by applying an insulation test voltage ≥ 3000 V rms for 1 second (current leakage detection limit = 5 μA).

INSULATION AND SAFETY-RELATED SPECIFICATIONS

Table 4.

Parameter	Symbol	Value	Unit	Conditions
Rated Dielectric Insulation Voltage		2500	V rms	1 minute duration
Minimum External Air Gap (Clearance)	L(I01)	7.7 min	mm	Measured from input terminals to output terminals, shortest distance through air
Minimum External Tracking (Creepage)	L(I02)	8.1 min	mm	Measured from input terminals to output terminals, shortest distance path along body
Minimum Internal Gap (Internal Clearance)		0.017 min	mm	Insulation distance through insulation
Tracking Resistance (Comparative Tracking Index)	CTI	>175	V	DIN IEC 112/VDE 0303 Part 1
Isolation Group		IIIa		Material Group (DIN VDE 0110, 1/89, Table 1)

RECOMMENDED OPERATING CONDITIONS

Table 5.

Parameter	Symbol	Min	Max	Unit
Operating Temperature	T _A	-40	+105	°C
Input Supply Voltage ¹	V _{DD1}	4.5	5.5	V
Output Supply Voltages ¹	V _{DDA} , V _{ddb}	12	18	
Input Signal Rise and Fall Times			100	ns
Common-Mode Transient Immunity, Input-to-Output ²		-75	+75	kV/μs
Common-Mode Transient Immunity, Between Outputs ²		-75	+75	kV/μs
Transient Immunity, Supply Voltages ²		-75	+75	kV/μs

¹ All voltages are relative to their respective ground.

² See the Common-Mode Transient Immunity section for additional data.

ABSOLUTE MAXIMUM RATINGS

Ambient temperature = 25°C, unless otherwise noted.

Table 6.

Parameter	Rating
Storage Temperature (T_{ST})	-55°C to +150°C
Ambient Operating Temperature (T_A)	-40°C to +105°C
Input Supply Voltage (V_{DD1}) ¹	-0.5 V to +7.0 V
Output Supply Voltage ¹ (V_{DDA} , V_{ddb})	-0.5 V to +27 V
Input Voltage ¹ (V_{IA} , V_{IB})	-0.5 V to $V_{DD1} + 0.5$ V
Output Voltage ¹	
V_{OA}	-0.5 V to $V_{DDA} + 0.5$ V
V_{OB}	-0.5 V to $V_{ddb} + 0.5$ V
Input-to-Output Voltage ²	-700 V_{PEAK} to +700 V_{PEAK}
Output Differential Voltage ³	700 V_{PEAK}
Output DC Current (I_{OA} , I_{OB})	-20 mA to +20 mA
Common-Mode Transients ⁴	-100 kV/ μ s to +100 kV/ μ s

¹ All voltages are relative to their respective ground.

² Input-to-output voltage is defined as $GND_A - GND_1$ or $GND_B - GND_1$.

³ Output differential voltage is defined as $GND_A - GND_B$.

⁴ Refers to common-mode transients across any insulation barrier. Common-mode transients exceeding the absolute maximum ratings may cause latch-up or permanent damage.

Stresses above those listed under Absolute Maximum Ratings may cause permanent damage to the device. This is a stress rating only; functional operation of the device at these or any other conditions above those indicated in the operational section of this specification is not implied. Exposure to absolute maximum rating conditions for extended periods may affect device reliability.

ESD CAUTION



ESD (electrostatic discharge) sensitive device.

Charged devices and circuit boards can discharge without detection. Although this product features patented or proprietary protection circuitry, damage may occur on devices subjected to high energy ESD. Therefore, proper ESD precautions should be taken to avoid performance degradation or loss of functionality.

Table 7. Maximum Continuous Working Voltage¹

Parameter	Max	Unit	Constraint
AC Voltage, Bipolar Waveform	565	V peak	50-year minimum lifetime
AC Voltage, Unipolar Waveform		V peak	
Basic Insulation	700	V peak	Analog Devices recommended maximum working voltage
DC Voltage			
Basic Insulation	700	V peak	Analog Devices recommended maximum working voltage

¹ Refers to continuous voltage magnitude imposed across the isolation barrier. See the Insulation Lifetime section for more details.

ADuM1234

PIN CONFIGURATION AND FUNCTION DESCRIPTIONS

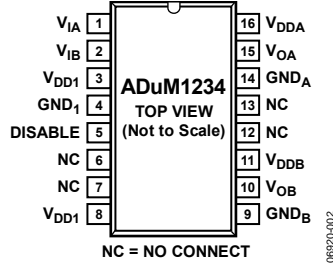

Figure 2. Pin Configuration

Table 8. ADuM1234 Pin Function Descriptions

Pin No.	Mnemonic	Description
1	V _{IA}	Logic Input A.
2	V _{IB}	Logic Input B.
3 ¹ , 8 ¹	V _{DD1}	Input Supply Voltage, 4.5 V to 5.5 V.
4	GND ₁	Ground Reference for Input Logic Signals.
5	DISABLE	Input Disable. Disables the isolator inputs and refresh circuits. Outputs take on default low state.
6, 7, 12 ² , 13 ²	NC	No Connect.
9	GND _B	Ground Reference for Output B.
10	V _{OB}	Output B.
11	V _{DDB}	Output B Supply Voltage, 12 V to 18 V.
14	GND _A	Ground Reference for Output A.
15	V _{OA}	Output A.
16	V _{DDA}	Output A Supply Voltage, 12 V to 18 V.

¹ Pin 3 and Pin 8 are internally connected. Connecting both pins to V_{DD1} is recommended.

² Pin 12 and Pin 13 are floating and should be left unconnected.

Table 9. Truth Table (Positive Logic)

V _{IA} /V _{IB} Input	V _{DD1} State	DISABLE	V _{OA} /V _{OB} Output	Notes
H	Powered	L	H	Output returns to input state within 1 μs of V _{DD1} power restoration.
L	Powered	L	L	
X	Unpowered	X	L	
X	Powered	H	L	

TYPICAL PERFORMANCE CHARACTERISTICS

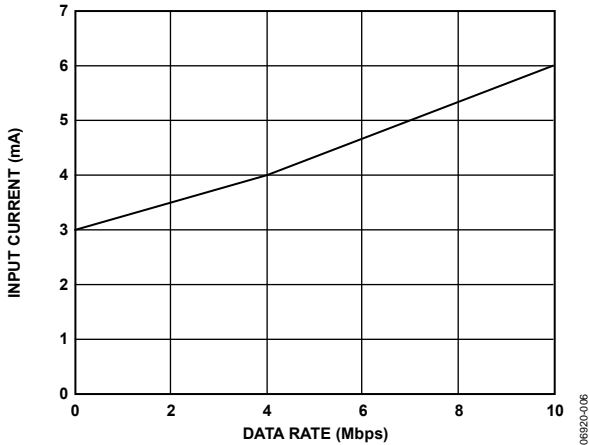

Figure 3. Typical Input Supply Current Variation with Data Rate

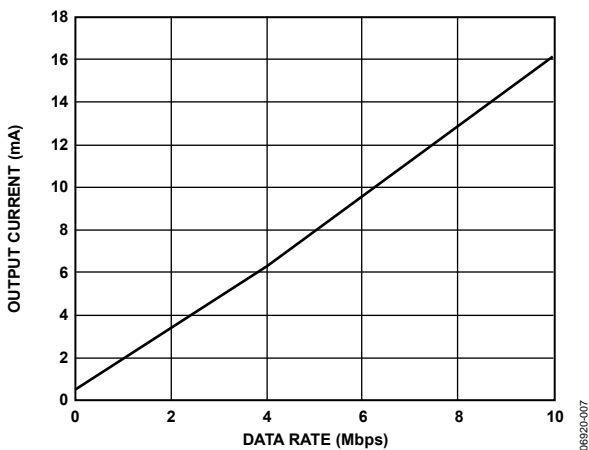

Figure 4. Typical Output Supply Current Variation with Data Rate

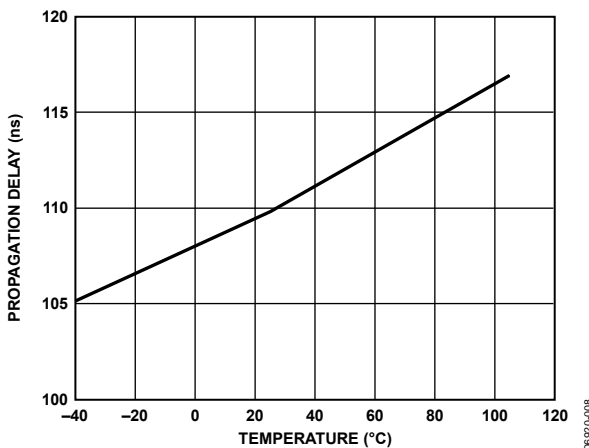

Figure 5. Typical Propagation Delay Variation with Temperature

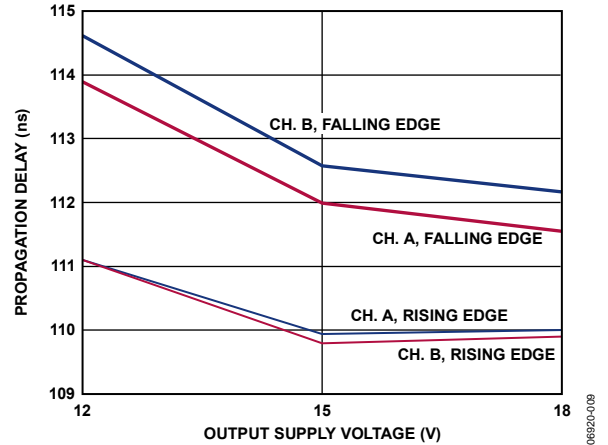

Figure 6. Typical Propagation Delay Variation with Output Supply Voltage (Input Supply Voltage = 5.0 V)

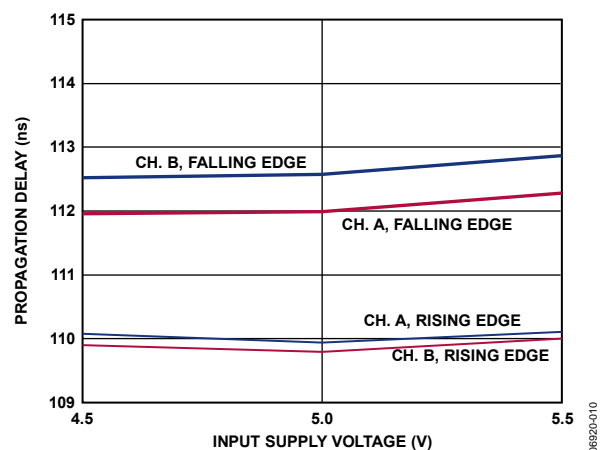

Figure 7. Typical Propagation Delay Variation with Input Supply Voltage (Output Supply Voltage = 15.0 V)

ADuM1234

APPLICATION NOTES

COMMON-MODE TRANSIENT IMMUNITY

In general, common-mode transients consist of linear and sinusoidal components. The linear component of a common-mode transient is given by

$$V_{CM, linear} = (\Delta V / \Delta t)t$$

where $\Delta V / \Delta t$ is the slope of the transient shown in Figure 11 and Figure 12.

The transient of the linear component is given by

$$dV_{CM} / dt = \Delta V / \Delta t$$

Figure 8 characterizes the ability of the ADuM1234 to operate correctly in the presence of linear transients. The data is based on design simulation and is the maximum linear transient magnitude that the ADuM1234 can tolerate without an operational error. This data shows a higher level of robustness than what is listed in Table 5 because the transient immunity values obtained in Table 5 use measured data and apply allowances for measurement error and margin.

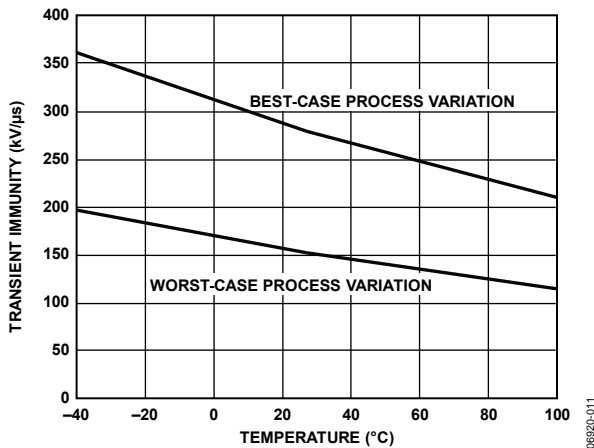

Figure 8. Transient Immunity (Linear Transients) vs. Temperature

The sinusoidal component (at a given frequency) is given by

$$V_{CM, sinusoidal} = V_0 \sin(2\pi ft)$$

where:

V_0 is the magnitude of the sinusoidal.

f is the frequency of the sinusoidal.

The transient magnitude of the sinusoidal component is given by

$$dV_{CM} / dt = 2\pi f V_0$$

Figure 9 and Figure 10 characterize the ability of the ADuM1234 to operate correctly in the presence of sinusoidal transients. The data is based on design simulation and is the maximum sinusoidal transient magnitude ($2\pi f V_0$) that the ADuM1234 can tolerate without an operational error. Values for immunity against sinusoidal transients are not included in Table 5 because measurements to obtain such values have not been possible.

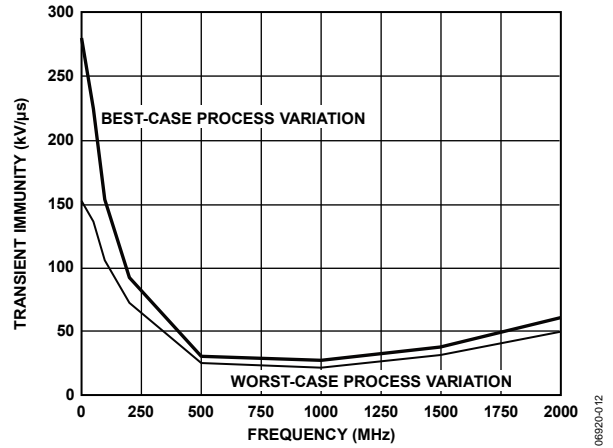

Figure 9. Transient Immunity (Sinusoidal Transients), 27°C Ambient Temperature

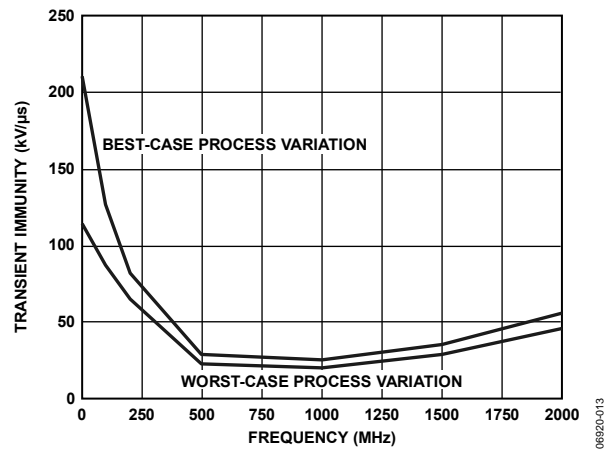

Figure 10. Transient Immunity (Sinusoidal Transients), 100°C Ambient Temperature

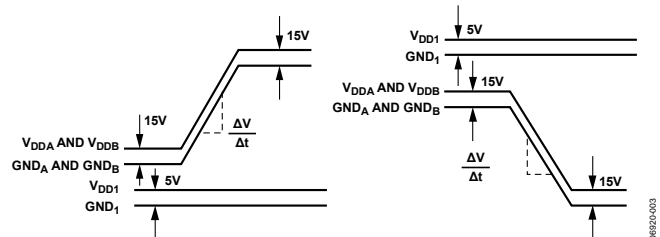

Figure 11. Common-Mode Transient Immunity Waveforms, Input to Output

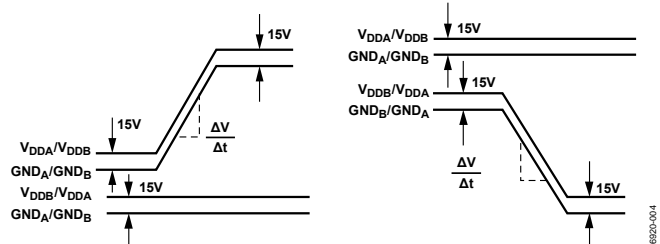

Figure 12. Common-Mode Transient Immunity Waveforms, Between Outputs



Figure 13. Transient Immunity Waveforms, Output Supplies

INSULATION LIFETIME

All insulation structures eventually break down when subjected to voltage stress over a sufficiently long period. The rate of insulation degradation depends on the characteristics of the voltage waveform applied across the insulation. In addition to the testing performed by the regulatory agencies, Analog Devices conducts an extensive set of evaluations to determine the lifetime of the insulation structure within the ADuM1234.

Analog Devices performs accelerated life testing using voltage levels higher than the rated continuous working voltage. Acceleration factors for several operating conditions are determined. These factors allow calculation of the time to failure at the actual working voltage. Table 7 summarizes the peak voltages for 50 years of service life for a bipolar ac operating condition and the maximum Analog Devices recommended working voltages. In many cases, the approved working voltage is higher than the 50-year service life voltage. Operation at these high working voltages can lead to shortened insulation life in some cases.

The insulation lifetime of the ADuM1234 depends on the voltage waveform type imposed across the isolation barrier. The iCoupler insulation structure degrades at different rates depending on whether the waveform is bipolar ac, unipolar ac, or dc. Figure 14, Figure 15, and Figure 16 illustrate these different isolation voltage waveforms.

Bipolar ac voltage is the most stringent environment. The goal of a 50-year operating lifetime under the ac bipolar condition

determines the maximum working voltage recommended by Analog Devices.

In the case of unipolar ac or dc voltage, the stress on the insulation is significantly lower. This allows operation at higher working voltages while still achieving a 50-year service life. The working voltages listed in Table 7 can be applied while maintaining the 50-year minimum lifetime provided the voltage conforms to either the unipolar ac or dc voltage cases. Any cross insulation voltage waveform that does not conform to Figure 15 or Figure 16 should be treated as a bipolar ac waveform and its peak voltage should be limited to the 50-year lifetime voltage value listed in Table 7. Note that the voltage presented in Figure 15 is shown as sinusoidal for illustration purposes only. It is meant to represent any voltage waveform varying between 0 V and some limiting value. The limiting value can be positive or negative, but the voltage cannot cross 0 V.

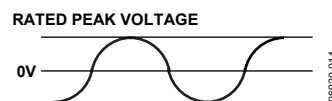

Figure 14. Bipolar AC Waveform

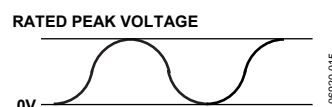

Figure 15. Unipolar AC Waveform

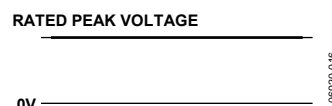
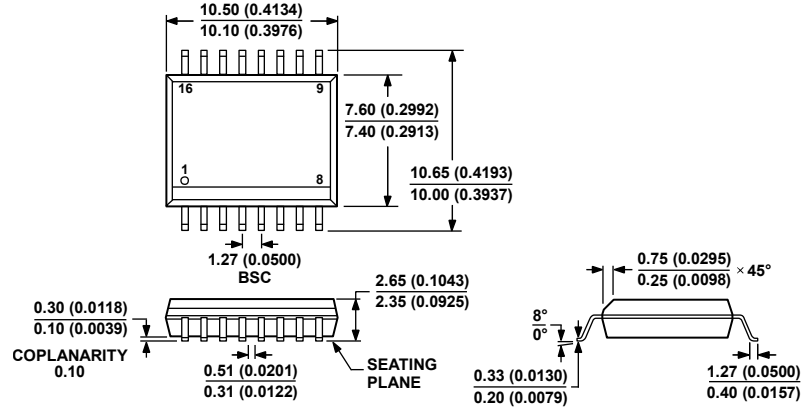

Figure 16. DC Waveform

ADuM1234

OUTLINE DIMENSIONS



COMPLIANT TO JEDEC STANDARDS MS-013-AA
 CONTROLLING DIMENSIONS ARE IN MILLIMETERS; INCH DIMENSIONS
 (IN PARENTHESES) ARE ROUNDED-OFF MILLIMETER EQUIVALENTS FOR
 REFERENCE ONLY AND ARE NOT APPROPRIATE FOR USE IN DESIGN.

Figure 17. 16-Lead Standard Small Outline Package [SOIC_W]
 Wide Body (RW-16)

Dimensions shown in millimeters and (inches)

032707-B

ORDERING GUIDE

Model	No. of Channels	Output Peak Current (A)	Output Voltage (V)	Temperature Range	Package Description	Package Option
ADuM1234BRWZ ¹	2	0.1	15	-40°C to +105°C	16-Lead SOIC_W	RW-16
ADuM1234BRWZ-RL ^{1, 2}	2	0.1	15	-40°C to +105°C	16-Lead SOIC_W	RW-16

¹ Z = RoHS Compliant Part.

² 13-inch tape and reel option (1,000 units).

NOTES

ADuM1234

NOTES