

# IMT-901 - Microstep Constant Current Driver "IC"



The IMT 901 is a PWM chopper type sinusoidal micro step bipolar stepping motor driver. Sinusoidal micro step operation is generated by means of built-in hardware and is outputted for operation by clock signal inputting.

## Advantages:

- only one IC for power and logic (up to 2,5 A/phase) reduces considerably space, assembly time and cost of a microstep driver with a max. functions yet with a min. of ext. components.
- selectable from: 1/1-, 1/2-, 1/4-, 1/8-Step enables individual application-related microstep switching, smooth and constant running and reduces considerably system resonance.
- Current down system or current zeroing reduces or eliminates motor power losses and heating during stand-still

## Dimensions (mm)

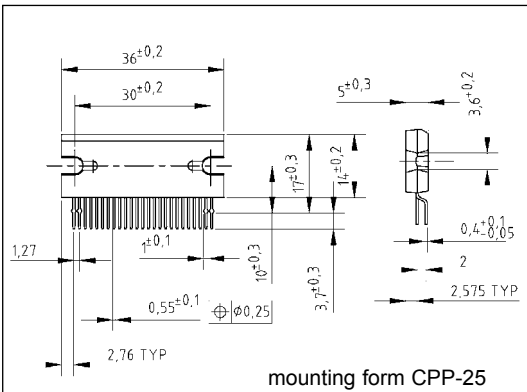

## PIN-Assignment

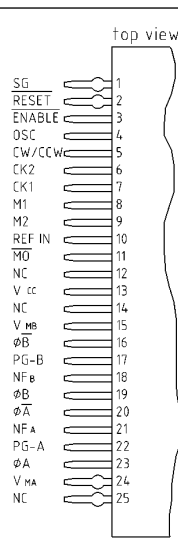

## max. Nominal Values (at 25 °C)

Supply voltage $V_{CC}$ :	5,5 V
$V_M$ :	40 V
Output current $I_{out}$ :	1,5 A (AVE) 2,5 A (peak)
Power dissipation $P_d$ :	4 W/40 W without/with heat sink
Operation temp.:	-40°C to 85°C
Storage temp.:	-55°C to 150°C

Input		Mode
M1	M2	
L	L	1/1 Step
H	L	1/2 Step
L	H	1/4 Step
H	H	1/8 Step

Signal Circuit times  
 t1: pulse width >10µs  
 t2: pulse width >10µs  
 t3: > 5µs  
 t4: >10µs

## Inputs

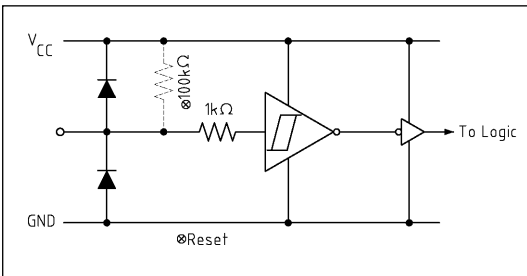

## Input-/Output-Signals

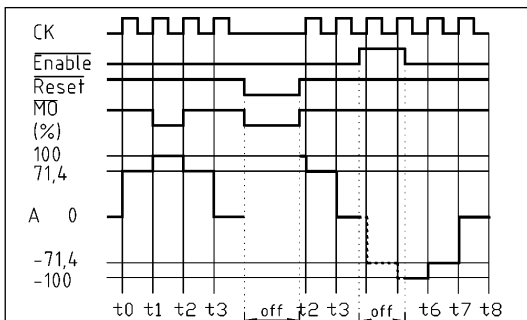

## Thermal Behavior

- ① INFINITE HEAT SINK  
 $R_{th(j-c)} = 1,5°C/W$
- ② HEAT SINK  
{with 3,5°C/W Heat Pin and 1,5°C contact thermal Resistance; Total 5°C/W}
- ③ NO HEAT SINK  
 $R_{th(j-a)} = 25°C/W$

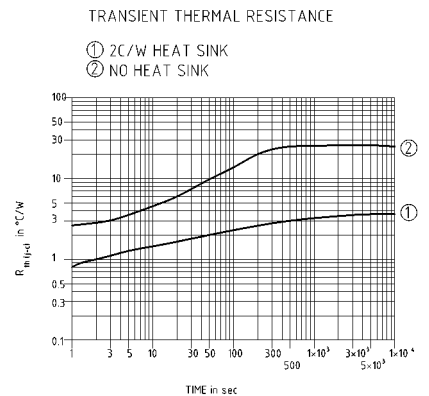
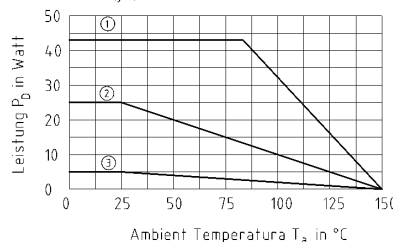

Function Table

INPUT					MODE
CK1	CK2	CW/CCW	Enable	Reset	
	H	L	L	H	CW
	L	L	L	H	INHIBIT
H		L	L	H	CCW
L		L	L	L	INHIBIT
	H	H	L	H	CCW
	L	H	L	H	INHIBIT
H		H	L	H	CW
L		H	L	H	INHIBIT
X	X	X	H	H	Z
X	X	X	X	L	Z

Block diagram (+ external Circuit)

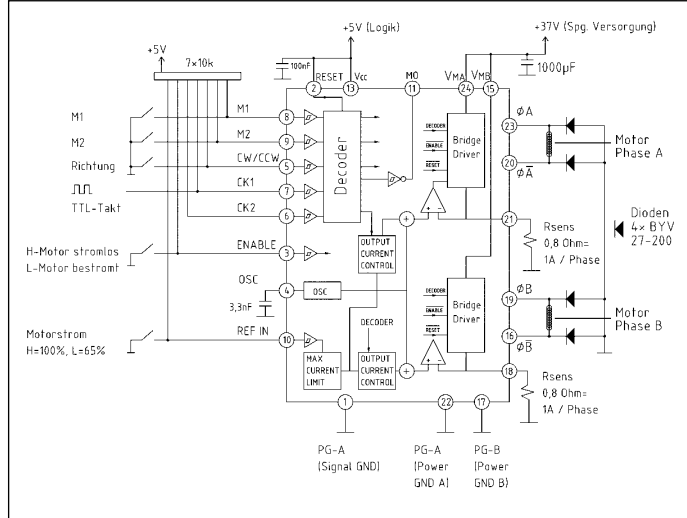

Full-/Half-Step Mode

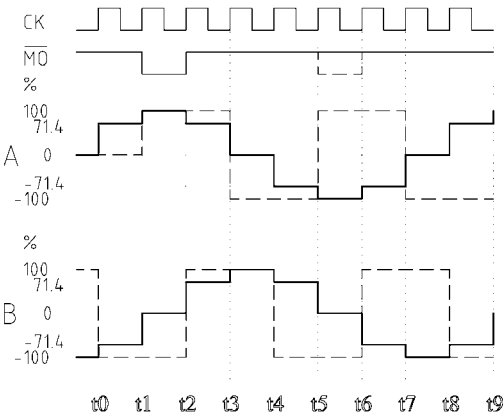

Quarter-/Eighth-Step Mode

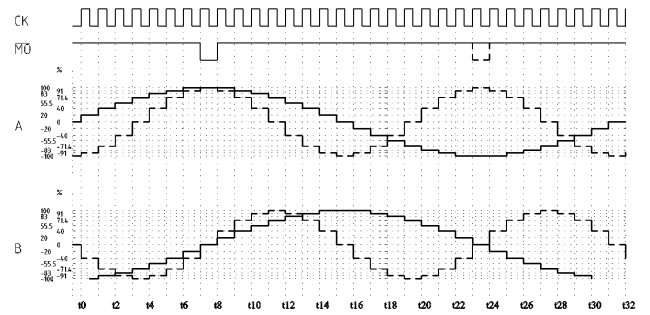

Electrical Characteristics 1 (Ta=25°, VCC=5V, VM=24V)

CHARACTERISTICS	SYMBOL	TEST CIRCUIT	TEST CONDITION	MIN.	TYP.	MAX.		
NF Terminal Current	$I_{NF}$	-	SOURCE TYPE	-	170	-		
OSC Frequency	$f_{OSC}$	-	$C_{OSC}=0.0033\mu F$	25	44	62		
Output Saturation Voltage	$V_{SAT(U)}$	Upper Side	$I_{OUT}=0.8 A$	-	1.8	2.2		
		Lower Side		$V_{SAT(L)}$	-	1.1	1.5	
A-B CHOPPING CURRENT (Note 1)	VECTOR	2W1-2e	W1-2e	1-2e	$\Delta I=0/8$	-	100	-
		2W1-2e	-	-	$\Delta I=1/8$	-	100	-
		2W1-2e	W1-2e	-	$\Delta I=2/8$	96	91	96
		2W1-2e	-	-	$\Delta I=3/8$	78	83	88
		2W1-2e	W1-2e	1-2e	$\Delta I=4/8$	66.4	71.4	76.4
		2W1-2e	-	-	$\Delta I=5/8$	50.5	55.5	60.5
		2W1-2e	W1-2e	-	$\Delta I=6/8$	35	40	45
		2W1-2e	-	-	$\Delta I=7/8$	15	20	25
2 Phase excitation mode VECTOR	-	-	-	-	141	-		
Feed Back Voltage Step	$\Delta V_{FB}$	-	$\Delta I=0/8-1/8$	-	0	-		
		-	$\Delta I=1/8-2/8$	32	72	112		
		-	$\Delta I=2/8-3/8$	24	64	104		
		-	$\Delta I=3/8-4/8$	53	93	133		
		-	$\Delta I=4/8-5/8$	87	127	167		
		-	$\Delta I=5/8-6/8$	84	124	164		
Output T <sub>s</sub> Switching Characteristics	$t_s$	L	$R_L=2\Omega, V_{IN}=0V, C_L=15pF$	-	0.3	-		
		L	-	-	2.2	-		
		$t_{OH}$	-	-	1.5	-		
		$t_{OL}$	CK-Output	-	2.7	-		
		$t_{OH}$	-	-	5.4	-		
		$t_{OL}$	OSC-Output	-	6.3	-		
		$t_{OH}$	-	-	2.0	-		
		$t_{OL}$	RESET-Output	-	2.5	-		
		$t_{OH}$	-	-	5.0	-		
		$t_{OL}$	ENABLE-Output	-	6.0	-		
Output Leakage Current	Upper Side	$I_{OL}$	-	-	50	-		
	Lower Side	$I_{OL}$	$V_{FB}=30V$	-	-	50		
Output Voltage	$V_{OH(MO)}$	-	$I_{OH}=-40\mu A$	4.5	4.9	$V_{CC}$		
	$V_{OL(MO)}$	-	$I_{OL}=-40\mu A$	GND	4.1	0.5		

Note : Maximum Current (9e=0) : 100%  
 2W1-2e: 2W1, 2 phase excitation mode  
 W1-2e: W1, 2 phase excitation mode  
 1-2e: 1, 2 phase excitation mode

Electrical Characteristics 2 (Ta=25°, VCC=5V, VM=24V)

CHARACTERISTIC	SYMBOL	TEST CIRCUIT	TEST CONDITION	MIN.	TYP.	MAX.	UNIT
Input Voltage	High	$V_{IN(H)}$	M1, M2, CW/CCW, REF IN	3.5	-	$V_{CC} + 0.4$	V
	Low	$V_{IN(L)}$	ENABLE, CK1, CK2 RESET	GND - 0.4	-	1.5	V
Input Hysteresis Voltage	$V_H$	-	-	-	600	-	mV
Input Current	$I_{IN-1(H)}$	-	M1, M2, REF IN, ENABLE $V_{IN} = 5.0 V$	-	-	100	nA
	$I_{IN-1(L)}$	-	RESET, $V_{IN}=0 V$ INTERNAL PULL-UP-RESISTOR	10	50	100	µA
	$I_{IN-2(L)}$	-	SOURCE TYPE, $V_{IN} = 0 V$	-	-	100	nA
Quiescent Current	$V_{CC}$	$I_{CC1}$	Output Open RESET : H, ENABLE : L (2,1 - 2 Phase excitation)	-	10	18	mA
	$V_{CC}$	$I_{CC2}$	Output Open (W1-2, 2W1-2 Phase Excitation) RESET : H, ENABLE : L	-	10	18	
	$V_{CC}$	$I_{CC3}$	RESET : L, ENABLE : L	-	5	-	
	$V_{CC}$	$I_{CC4}$	RESET : H, ENABLE : L	-	5	-	
Comparator Reference Voltage	$V_{NF(H)}$	-	REF IN H Output Open	0.72	0.8	0.88	V
	$V_{NF(L)}$	-	REF IN H Output Open	0.45	0.5	0.55	
Output Differential	$\Delta V_D$	-	B/A $C_{OSC} = 0.0033 \mu F, R_{NF} = 0.8 \Omega$	-10	-	10	%
Output Voltage	$V_{OH(MO)}$	-	$I_{OH} = -40\mu A$	4.5	4.9	$V_{CC}$	mV
	$V_{OL(MO)}$	-	$I_{OL} = -40\mu A$	GND	0.1	0.5	mV