

PRELIMINARY

NEC NEC LCD Technologies, Ltd.

TFT COLOR LCD MODULE

NL204153BC21-02

54cm (21.3 Type)

QXGA

PRELIMINARY DATA SHEET 

DOD-PD-0092 (2nd edition)

**All information is subject to change without notice.
Please confirm the sales representative before
starting to design your system.**

INTRODUCTION

No part of this document shall be copied in any form or by any means without the prior written consent of NEC LCD Technologies, Ltd. (hereinafter called "NEC").

NEC does not assume any liability for infringement of patents, copyrights or other intellectual property rights of third parties by or arising from use of a product described herein or any other liability arising from use of such application. No license, express, implied or otherwise, is granted under any patents, copyrights or other intellectual property rights of NEC or of others.

While NEC has been making continuous effort to enhance the reliability of its products, the possibility of failures cannot be eliminated entirely. To minimize risks of damage to property or injury to person arising from a failure in an NEC product, customers must incorporate sufficient safety measures in their design, such as redundancy, fire-containment and anti-failure features.

NEC products are classified into the following three quality grades:

"Standard", "Special", "Specific"

The *"Specific"* quality grade applies only to applications developed based on a customer designated "quality assurance program" for a specific application. The recommended applications of a product depend on its quality grade, as indicated below. Customers must check the quality grade of each application before using it in a particular application.

Standard: Computers, office equipment, communications equipment, test and measurement equipment, audio and visual equipment, home electronic appliances, machine tools, personal electronic equipment and industrial robots

Special: Transportation equipment (automobiles, trains, ships, etc.), traffic control systems, anti-disaster systems, anti-crime systems, safety equipment and medical equipment (not specifically designed for life support)

Specific: Military systems, aircraft, aerospace equipment, submersible repeaters, nuclear reactor control systems, life support systems (medical equipment, etc.) and any other equipment

The quality grade of this product is *"Standard"* unless otherwise specified in this document. If customers intend to use this product for applications other than those specified for *"Standard"* quality grade, they should contact NEC sales representative in advance.

CONTENTS

INTRODUCTION.....	2
1. OUTLINE	4
1.1 STRUCTURE AND PRINCIPLE	4
1.2 APPLICATIONS	4
1.3 FEATURES	4
2. GENERAL SPECIFICATIONS.....	5
3. BLOCK DIAGRAM	6
4. DETAILED SPECIFICATIONS.....	7
4.1 MECHANICAL SPECIFICATIONS	7
4.2 ABSOLUTE MAXIMUM RATINGS.....	7
4.3 ELECTRICAL CHARACTERISTICS	8
4.3.1 Driving for LCD panel signal processing board	8
4.3.2 Driving for backlight lamp.....	9
4.3.3 Power supply voltage ripple.....	10
4.3.4 Fuse.....	10
4.4 POWER SUPPLY VOLTAGE SEQUENCE.....	11
4.5 CONNECTIONS AND FUNCTIONS FOR INTERFACE PINS	12
4.5.1 LCD panel signal processing board	12
4.5.2 Backlight inverter.....	14
4.5.3 Positions of plugs and sockets.....	14
4.6 METHOD OF CONNECTION FOR LVDS TRANSMITTER	15
4.7 10-bit LOOK UP TABLE FOR GAMMA ADJUSTMENT	17
4.8 DISPLAY COLORS AND INPUT DATA SIGNALS	17
4.9 DISPLAY POSITIONS	18
4.10 PIXEL ARRANGMENT.....	18
4.11 LVDS DATA TRANSMISSION METHOD.....	18
4.12 INPUT SIGNAL TIMINGS FOR LCD PANEL SIGNAL PROCESSING BOARD	19
4.12.1 Input signal specifications	19
4.12.2 Input signals timing chart.....	20
4.13 OPTICS	21
4.13.1 Optical characteristics	21
4.13.2 Definition of contrast ratio	22
4.13.3 Definition of luminance uniformity.....	22
4.13.4 Definition of response times.....	22
4.13.5 Definition of viewing angles	22
5. RELIABILITY TESTS.....	23
6. PRECAUTIONS.....	24
6.1 MEANING OF CAUTION SIGNS	24
6.2 CAUTIONS	24
6.3 ATTENTIONS.....	24
6.3.1 Handling of the product.....	24
6.3.2 Environment	25
6.3.3 Characteristics	25
6.3.4 Other.....	25
7. OUTLINE DRAWINGS	26
7.1 FRONT VIEW	26
7.2 REAR VIEW	27
REVISION HISTORY	28

1. OUTLINE

1.1 STRUCTURE AND PRINCIPLE

NL204153BC21-02 module is composed of the amorphous silicon thin film transistor liquid crystal display (a-Si TFT LCD) panel structure with driver LSIs for driving the TFT (Thin Film Transistor) array and a backlight.

The a-Si TFT LCD panel structure is injected liquid crystal material into a narrow gap between the TFT array glass substrate and a color-filter glass substrate.

Color (Red, Green, Blue) data signals from a host system (e.g. PC, signal generator, etc.) are modulated into best form for active matrix system by a signal processing board, and sent to the driver LSIs which drive the individual TFT arrays.

The TFT array as an electro-optical switch regulates the amount of transmitted light from the backlight assembly, when it is controlled by data signals. Color images are created by regulating the amount of transmitted light through the TFT array of red, green and blue dots.

1.2 APPLICATIONS

- EWS monitors
- Monitors for CAD system

1.3 FEATURES

- Ultra-wide viewing angle (with lateral electric field)
- High resolution
- Low reflection
- 4port-LVDS interface
- High luminance
- Small foot print
- Incorporated edge light type backlight (Inverter less)

2. GENERAL SPECIFICATIONS

Display area	433.152 (W) × 324.864 (H) mm (typ.)
Diagonal size of display	54 cm (21.3 inches)
Drive system	a-Si TFT active matrix
Display color	16,777,216 colors
Pixel	2048 (H) × 1536 (V) pixels
Pixel arrangement	RGB (Red dot, Green dot, Blue dot) vertical stripe
Dot pitch	0.0705 (W) × 0.2115 (H) mm
Pixel pitch	0.2115 (W) × 0.2115 (H) mm
Module size	457.0 (W) × 350.0 (H) × 25.0 (D) mm (typ.)
Weight	4400 g (typ.)
Contrast ratio	500:1 (typ.)
Viewing angle	At the contrast ratio 10:1 <ul style="list-style-type: none"> • Horizontal: Right side 85° (typ.), Left side 85° (typ.) • Vertical: Up side 85° (typ.), Down side 85° (typ.)
Designed viewing direction	Viewing angle with optimum grayscale ($\gamma=2.2$): normal axis
Polarizer surface	TBD
Polarizer pencil-hardness	TBD H (min.) [by JIS K5400]
Color gamut	At LCD panel center 72 % (typ.) [against NTSC color space]
Response time	T_{on} (black 10% → white 90%) + T_{off} (white 90% → black 10%) TBD ms (typ.)
Luminance	At $IBL = (6.5)mArms / lamp$ 235 cd/m ² (typ.)
Signal system	4 ports LVDS interface (Equivalent of THC63LVD824×2pcs, Thine Electronics, Inc.) RGB 8-bit signals, Data enable signal (DE)
Power supply voltage	LCD panel signal processing board: 12.0V
Backlight	Edge light type: 6 cold cathode fluorescent lamps, Inverter less
Power consumption	At checkered flag pattern and $IBL = (6.5)mArms / lamp$ TBD W (typ.)

3. BLOCK DIAGRAM

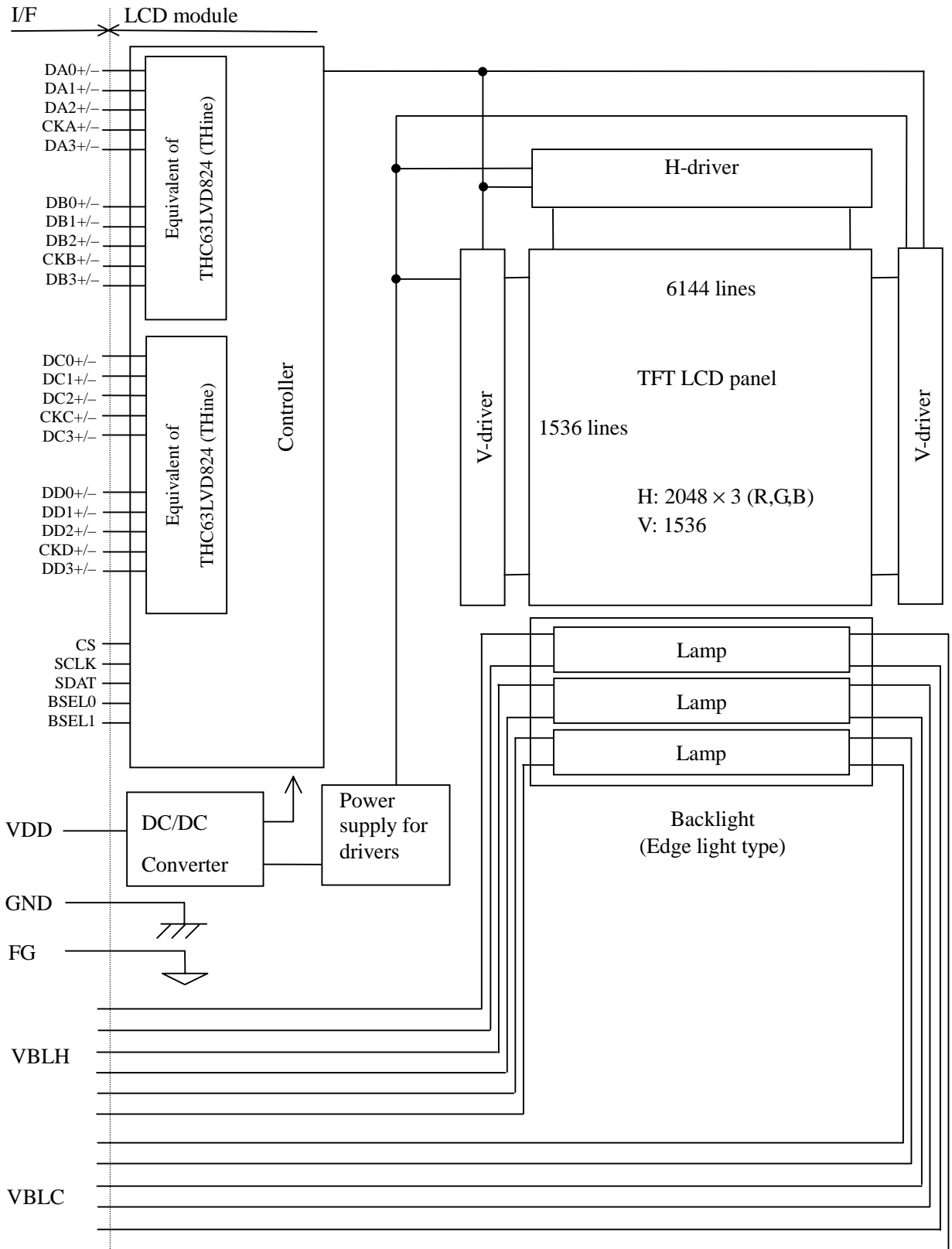

Note1: GND is signal ground for logic and LCD driving. GND and FG (Frame Ground) are not connected together in the LCD module. These grounds should be connected in customer equipment.

4. DETAILED SPECIFICATIONS

4.1 MECHANICAL SPECIFICATIONS

Parameter	Specification	Unit
Module size	457.0 ± 1.0 (W) × 350.0 ± 1.0 (H) × 25.0 ± 0.5 (D) Note1	mm
Display area	433.152 (W) × 324.864 (H) Note1	mm
Weight	4400 (typ.), TBD (max.)	g

Note1: See "7. OUTLINE DRAWINGS".

4.2 ABSOLUTE MAXIMUM RATINGS

Parameter		Symbol	Rating	Unit	Remarks
Power supply voltage	LCD panel signal processing board	VDD	-0.3 to +15.0	V	Ta = 25°C
	Lamp voltage	VBLH	TBD	Vrms	
Input voltage for signals	Display signals Note1	VD	-0.3 to +3.6	V	Ta = 25°C VDD=12.0V
	Function signals Note2	VF	-0.3 to +3.9	V	
Storage temperature		Tst	-20 to +60	°C	-
Operating temperature	Front surface	TopF	0 to +55	°C	Note3
	Rear surface	TopR	0 to + TBD	°C	Note4
Relative humidity Note5		RH	≤ 95	%	Ta ≤ 40°C
			≤ 85	%	40 < Ta ≤ 50°C
			≤ 70	%	50 < Ta ≤ 55°C
Absolute humidity Note5		AH	≤ 73 Note6	g/m ³	Ta > 55°C

Note1: DA0+/-, DA1+/-, DA2+/-, DA3+/-, CKA+/-, DB0+/-, DB1+/-, DB2+/-, DB3+/-, CKB+/-, DC0+/-, DC1+/-, DC2+/-, DC3+/-, CKC+/-, DD0+/-, DD1+/-, DD2+/-, DD3+/-, CKD+/-.

Note2: CS, SCLK, SDAT, BSEL0, BSEL1

Note3: Measured at center of LCD panel surface (including self-heat)

Note4: Measured at center of LCD module's rear shield surface (including self-heat)

Note5: No condensation

Note6: Ta = 55°C, RH = 70%

PRELIMINARY

4.3 ELECTRICAL CHARACTERISTICS

4.3.1 Driving for LCD panel signal processing board

(Ta = 25°C)

Parameter	Symbol	min.	typ.	max.	Unit	Remarks
Supply voltage	VDD	10.8	12.0	13.2	V	-
Ripple voltage	VRP	-	-	100	mV	for VDD
Differential input "L" Threshold voltage	ViTL	-100	-	-	mV	at VCM=1.2V VCM: Common mode voltage for LVDS driver Note1
Differential input "H" Threshold voltage	ViTH	-	-	+100	mV	Note1
Input voltage width	Vi	0	-	2.4	V	-
Terminating resistor	RT	-	100	-	Ω	-
Logic input "L" level	ViCL	0	-	0.8	V	Note2
Logic input "L" level	ViCH	Open		Note3	-	
Logic input "L" current	IiCL	-10	-	10	μA	
Supply current	IDD	-	(700) Note4	TBD Note5	mA	at VDD=12.0V

Note1: DA0+/-, DA1+/-, DA2+/-, DA3+/-, CKA+/-, DB0+/-, DB1+/-, DB2+/-, DB3+/-, CKB+/-, DC0+/-, DC1+/-, DC2+/-, DC3+/-, CKC+/-, DD0+/-, DD1+/-, DD2+/-, DD3+/-, CKD+/-.

Note2: CS, SCLK, SDAT, BSEL0, BSEL1

Note3: "H" must be "Open".

Note4: Checkered flag pattern (by EIAJ ED-2522)

Note5: Pattern for maximum current

4.3.2 Driving for backlight lamp

(Ta=25°C, Note1)

Parameter	Symbol	min.	typ.	max.	Unit	Remarks
Lamp current	IBL	TBD	(6.5)	TBD	mArms	at IBL=6.5mArms: cd/m ² Note3
Lamp voltage	VBLH	-	(800)	-	Vrms	Note2, Note3
Lamp starting voltage	VS	(1220)	-	-	Vrms	Ta = 25°C Note2, Note3
		(1460)	-	-	Vrms	Ta = 0°C Note2, Note3
Oscillation frequency	FO	TBD	(56)	TBD	kHz	Note4

2

Note1: This product's backlight consists of 6 lamps, and these specifications are for each lamp.

Note2: The lamp voltage cycle between lamps should be kept on a same phase. "VS" and "VBLH" are the voltage value between low voltage side (Cold) and high voltage side (Hot).

Note3: The asymmetric ratio of working waveform for lamps (Lamp voltage peak ratio, Lamp current peak ratio and waveform space ratio) should be less than 5 % (See the following figure.). If the waveform is asymmetric, DC (Direct current) element apply into the lamp. In this case, a lamp lifetime may be shortened, because a distribution of a lamp enclosure substance inclines toward one side between low voltage terminal (Cold terminal) and high voltage terminal (Hot terminal).

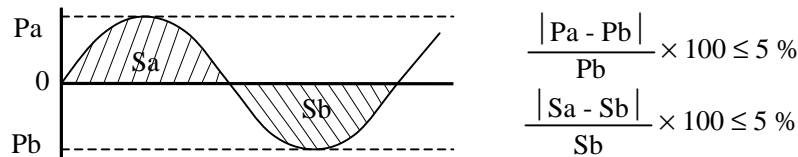

Pa: Supply voltage/current peak for positive, Pb: Supply voltage/current peak for negative
 Sa: Waveform space for positive part, Sb: Waveform space for negative part

Note4: In case "FO" is not the recommended value, beat noise may display on the screen, because of interference between "FO" and "1/th". Recommended value of "FO" is as following.

$$FO = \frac{1}{4} \times \frac{1}{th} \times (2n-1)$$

th: Horizontal cycle period (See "4.12.1 Input signal specifications".)

n: Natural number (1, 2, 3)

Note5: Method of lamp cable installation may invite fluctuation of lamp current and voltage or asymmetric of lamp working waveform. When designing method of lamp cable installation, evaluate the fluctuation of lamp current, voltage and working waveform sufficiently.

4.3.3 Power supply voltage ripple

This product works, even if the ripple voltage levels are beyond the permissible values as following the table, but there might be noise on the display image.

Parameter	Power supply voltage	Ripple voltage (Measure at input terminal of power supply)	Note1 (Measure at input terminal of power supply)	Unit
VDD	12.0 V	≤ 100		mVp-p

Note1: The permissible ripple voltage includes spike noise.

4.3.4 Fuse

Parameter	Fuse		Rating	Fusing current	Remarks
	Type	Supplier			
VDD	TBD	TBD	TBD A	TBD A	Note1
			TBD V		

Note1: The power supply capacity should be more than the fusing current. If the power supply capacity is less than the fusing current, the fuse may not blow for a short time, and then nasty smell, smoking and so on may occur.

4.4 POWER SUPPLY VOLTAGE SEQUENCE

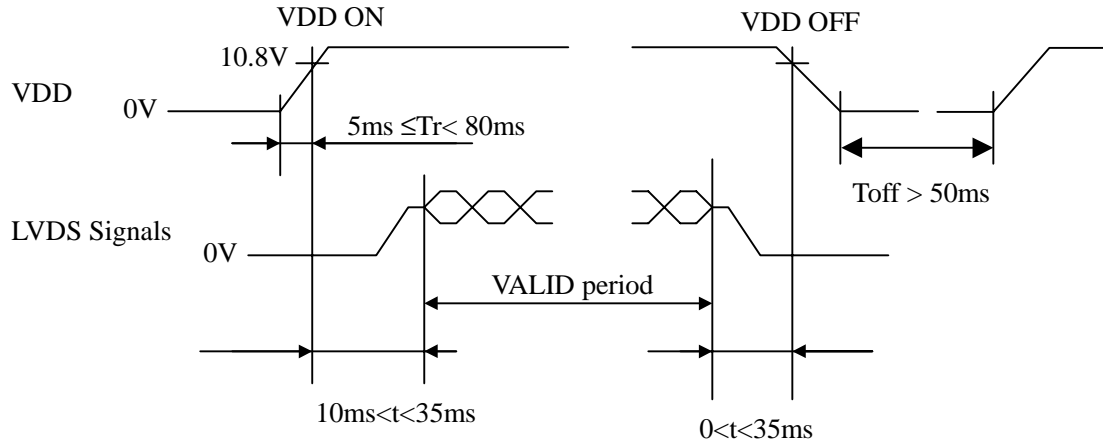

Note1: LVDS signals should be measured at the terminal of 100Ω resistor.

Note2: In terms of voltage variation (voltage drop) while VDD rising edge is below 10.8V, a protection circuit may work, and then this product may not work.

Note3: LVDS signals must be Low or High-impedance, exclude the VALID period (See above sequence diagram), in order to avoid that internal circuits is damaged.

If some of display and function signals of this product are cut while this product is working, even if the signal input to it once again, it might not work normally. If customer stops the display and function signals, they should be cut VDD.

Note4: The backlight power supply voltage should be inputted within the valid period, in order to avoid unstable data display.

4.5 CONNECTIONS AND FUNCTIONS FOR INTERFACE PINS

4.5.1 LCD panel signal processing board

CN1 socket (LCD module side): FI-WE41P-HF (Japan Aviation Electronics Industry Limited (JAE))
 Adaptable plug: FI-W41S (Japan Aviation Electronics Industry Limited (JAE))

Pin No.	Symbol	Function	Description	Pin No.	Symbol	Function	Description
1	RSVD1	This terminal must be set to Low.		21	DB1+	Pixel data B1	LVDS differential signal
2	N.C.	Keep this terminal Open.		22	DB1-		
3	CS	Chip selection	See "4.7 10-bit look up table for gamma adjustment".	23	GND	Ground	Signal ground
4	SCLK	Serial Clock					
5	SDAT	Serial Data					
6	RSVD2	Keep this terminal Open.		24	DB0+	Pixel data B0	LVDS differential signal
7	RSVD2						
8	BSEL0	Selection of bit mapping mode	See "4.6 Method of connection for LVDS transmitter".	25	DB0-	Pixel data B0	LVDS differential signal
9	BSEL1						
10	RSVD2	Keep this terminal Open.		26	GND	Ground	Signal ground
11	GND	Ground	Signal ground	27	DA3+	Pixel data A3	LVDS differential signal
12	DB3+	Pixel data B3	LVDS differential signal	28	DA3-		
13	DB3-						
14	GND	Ground	Signal ground	29	GND	Ground	Signal ground
15	CKB+	Pixel clock B	LVDS differential signal	30	CKA+	Pixel clock A	LVDS differential signal
16	CKB-						
17	GND	Ground	Signal ground	31	CKA-	Pixel clock A	LVDS differential signal
18	DB2+	Pixel data B2	LVDS differential signal	32	GND		
19	DB2-						
20	GND	Ground	Signal ground	33	DA2+	Pixel data A2	LVDS differential signal
				34	DA2-		
				35	GND	Ground	Signal ground
				36	DA1+	Pixel data A1	LVDS differential signal
				37	DA1-		
				38	GND	Ground	Signal ground
				39	DA0+	Pixel data A0	LVDS differential signal
				40	DA0-		
				41	GND	Ground	Signal ground

Note1: Twist pair wires with 100Ω (Characteristic impedance) should be connected between LCD panel signal processing board and LVDS transmitter.

CN1: Figure of socket

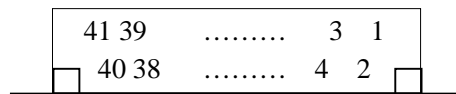

PRELIMINARY

CN2 socket: FI-WE31P-HF (Japan Aviation Electronics Industry Limited (JAE))

Adaptable plug: FI-W31S (Japan Aviation Electronics Industry Limited (JAE))

Pin No.	Symbol	Function	Description	Pin No.	Symbol	Function	Description
1	GND	Ground	Signal ground	16	GND	Ground	Signal ground
2	DD3+	Pixel data D3	LVDS differential signal	17	DC3+	Pixel data C3	LVDS differential signal
3	DD3-			18	DC3-		
4	GND	Ground	signal ground	19	GND	Ground	Signal ground
5	CKD+	Pixel clock D	LVDS differential signal	20	CKC+	Pixel clock C	LVDS differential signal
6	CKD-			21	CKC-		
7	GND	Ground	Signal ground	22	GND	Ground	Signal ground
8	DD2+	Pixel data D2	LVDS differential signal	23	DC2+	Pixel data C2	LVDS differential signal
9	DD2-			24	DC2-		
10	GND	Ground	Signal ground	25	GND	Ground	Signal ground
11	DD1+	Pixel data D1	LVDS differential signal	26	DC1+	Pixel data C1	LVDS differential signal
12	DD1-			27	DC1-		
13	GND	Ground	Signal ground	28	GND	Ground	Signal ground
14	DD0+	Pixel data D0	LVDS differential signal	29	DC0+	Pixel data C0	LVDS differential signal
15	DD0-			30	DC0-		
				31	GND	Ground	Signal ground

Note1: Twist pair wires with 100Ω (Characteristic impedance) should be connected between LCD panel signal processing board and LVDS transmitter.

CN2: Figure of socket



CN3 socket (LCD module side): IL-Z-8PL-SMTY (Japan Aviation Electronics Industry Limited (JAE))

Adaptable plug: IL-Z-8S-S125C (Japan Aviation Electronics Industry Limited (JAE))

Pin No.	Symbol	Function	Description
1	VDD	Power supply	-
2	VDD		
3	VDD		
4	VDD		
5	GND	Ground	-
6	GND		
7	GND		
8	GND		

CN3: Figure of socket

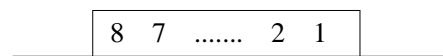

PRELIMINARY

4.5.2 Backlight inverter

Attention: VBLH and VBLC must be connected correctly. If customer connects wrongly, customer will be hurt and the module will be broken.

CN201-CN206 plug (Module side): BHSR-02VS-1 (J.S.T. Mfg Co., Ltd.)

Adaptable socket: SM02B-BHSS-1-TB (J.S.T. Mfg Co., Ltd.)

Pin No.	Symbol	Function	Remarks
1	VBLH	High voltage (Hot)	Cable color: TBD
2	VBLC	Low voltage (Cold)	Cable color: TBD

4.5.3 Positions of plugs and sockets

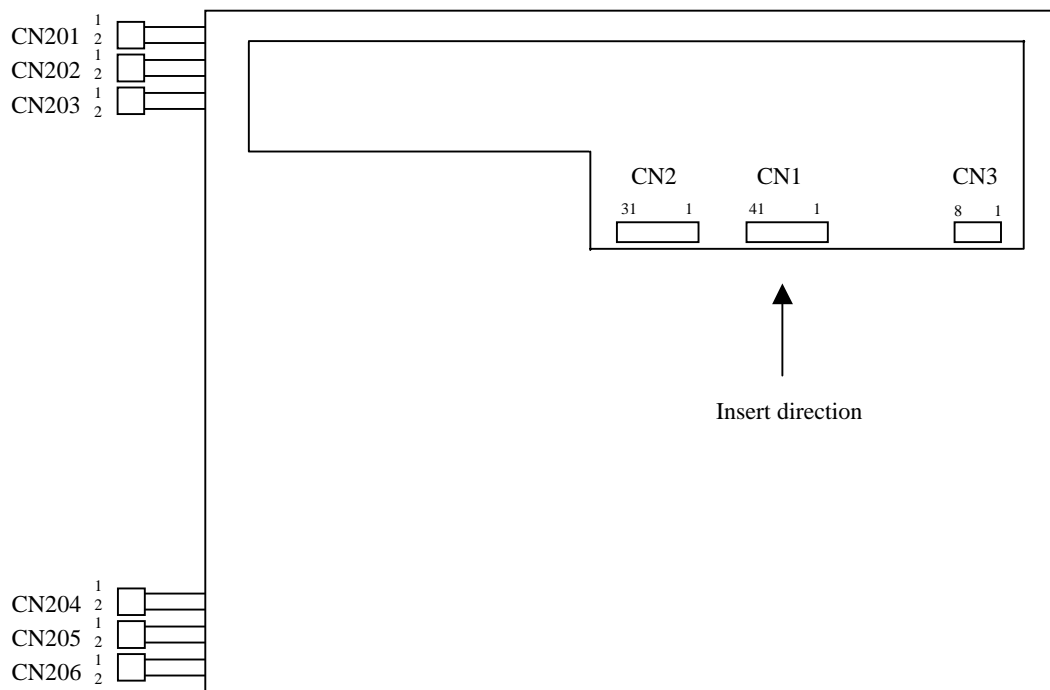

PRELIMINARY

4.6 METHOD OF CONNECTION FOR LVDS TRANSMITTER

LVDS data bit mapping mode is selectable with BSEL0 and BSEL1 terminal.

	Bit mapping			Transmitter Pin Assign			Output Connector	CN1		
	BSEL[1:0] Note1			Single type LVDS Tx	Dual type LVDS TX					
	[H:H], [L:L]	[H:L]	[L:H]		THine THC63LVD823	NS DS90C387				
Pixel data A	R2	R7	R0	TA0	R12	R10	ATA- ATA+	→		
	R3	R6	R1	TA1	R13	R11			40	DA0-
	R4	R5	R2	TA2	R14	R12			39	DA0+
	R5	R4	R3	TA3	R15	R13				
	R6	R3	R4	TA4	R16	R14				
	R7	R2	R5	TA5	R17	R15				
	G2	G7	G0	TA6	G12	G10				
	G3	G6	G1	TB0	G13	G11	ATB- ATB+	→		
	G4	G5	G2	TB1	G14	G12			37	DA1-
	G5	G4	G3	TB2	G15	G13			36	DA1+
	G6	G3	G4	TB3	G16	G14				
	G7	G2	G5	TB4	G17	G15				
	B2	B7	B0	TB5	B12	B10				
	B3	B6	B1	TB6	B13	B11				
	B4	B5	B2	TC0	B14	B12	ATC- ATC+	→		
	B5	B4	B3	TC1	B15	B13			34	DA2-
	B6	B3	B4	TC2	B16	B14			33	DA2+
	B7	B2	B5	TC3	B17	B15				
	Hsync	Hsync	Hsync	TC4	HSYNC	HSYNC				
	Vsync	Vsync	Vsync	TC5	VSYNC	VSYNC				
	DE	DE	DE	TC6	DE	DE				
	R0	R1	R6	TD0	R10	R16	ATD- ATD+	→		
	R1	R0	R7	TD1	R11	R17			28	DA3-
	G0	G1	G6	TD2	G10	G16			27	DA3+
G1	G0	G7	TD3	G11	G17					
B0	B1	B6	TD4	B10	B16					
B1	B0	B7	TD5	B11	B17					
N.C.	N.C.	N.C.	TD6	-	-					
CLK	CLK	CLK	CLK	CLK	CLK	ATCLK- ATCLK+	→	31	CKA-	
							→	30	CKA+	
Pixel data B	R2	R7	R0	TA0	R22	R20	BTA- BTA+	→		
	R3	R6	R1	TA1	R23	R21			25	DB0-
	R4	R5	R2	TA2	R24	R22			24	DB0+
	R5	R4	R3	TA3	R25	R23				
	R6	R3	R4	TA4	R26	R24				
	R7	R2	R5	TA5	R27	R25				
	G2	G7	G0	TA6	G22	G20				
	G3	G6	G1	TB0	G23	G21	BTB- BTB+	→		
	G4	G5	G2	TB1	G24	G22			22	DB1-
	G5	G4	G3	TB2	G25	G23			21	DB1+
	G6	G3	G4	TB3	G26	G24				
	G7	G2	G5	TB4	G27	G25				
	B2	B7	B0	TB5	B22	B20				
	B3	B6	B1	TB6	B23	B21				
	B4	B5	B2	TC0	B24	B22	BTC- BTC+	→		
	B5	B4	B3	TC1	B25	B23			19	DB2-
	B6	B3	B4	TC2	B26	B24			18	DB2+
	B7	B2	B5	TC3	B27	B25				
	Hsync	Hsync	Hsync	TC4	HSYNC	HSYNC				
	Vsync	Vsync	Vsync	TC5	VSYNC	VSYNC				
	DE	DE	DE	TC6	DE	DE				
	R0	R1	R6	TD0	R20	R26	BTD- BTD+	→		
	R1	R0	R7	TD1	R21	R27			13	DB3-
	G0	G1	G6	TD2	G20	G26			12	DB3+
G1	G0	G7	TD3	G21	G27					
B0	B1	B6	TD4	B20	B26					
B1	B0	B7	TD5	B21	B27					
N.C.	N.C.	N.C.	TD6	-	-					
CLK	CLK	CLK	CLK	CLK	CLK	BTCLK- BTCLK+	→	16	CKB-	
							→	15	CKB+	

Note1: "H" must be "Open".

PRELIMINARY

	BSEL[1:0] Note1			Single type LVDS Tx	Dual type LVDS TX		Output Connector	CN2		
	[H:H], [L:L]	[H:L]	[L:H]		THine THC63LVD823	NS DS90C387		Pin No.	Signal name	
Pixel data C	R2	R7	R0	TA0	R12	R10	CTA- CTA+	→		
	R3	R6	R1	TA1	R13	R11				
	R4	R5	R2	TA2	R14	R12				
	R5	R4	R3	TA3	R15	R13				
	R6	R3	R4	TA4	R16	R14				
	R7	R2	R5	TA5	R17	R15				
	G2	G7	G0	TA6	G12	G10				
	G3	G6	G1	TB0	G13	G11	CTB- CTB+	→		
	G4	G5	G2	TB1	G14	G12				
	G5	G4	G3	TB2	G15	G13				
	G6	G3	G4	TB3	G16	G14				
	G7	G2	G5	TB4	G17	G15				
	B2	B7	B0	TB5	B12	B10				
	B3	B6	B1	TB6	B13	B11				
	B4	B5	B2	TC0	B14	B12	CTC- CTC+	→		
	B5	B4	B3	TC1	B15	B13				
	B6	B3	B4	TC2	B16	B14				
	B7	B2	B5	TC3	B17	B15				
	Hsync	Hsync	Hsync	TC4	HSYNC	HSYNC				
	Vsync	Vsync	Vsync	TC5	VSYNC	VSYNC				
DE	DE	DE	TC6	DE	DE					
R0	R1	R6	TD0	R10	R16	CTD- CTD+	→			
R1	R0	R7	TD1	R11	R17					
G0	G1	G6	TD2	G10	G16					
G1	G0	G7	TD3	G11	G17					
B0	B1	B6	TD4	B10	B16					
B1	B0	B7	TD5	B11	B17					
N.C.	N.C.	N.C.	TD6	-	-					
CLK	CLK	CLK	CLK	CLK	CLK	CTCLK- CTCLK+	→	21	CKC- CKC+	
Pixel data D	R2	R7	R0	TA0	R22	R20	DTA- DTA+	→		
	R3	R6	R1	TA1	R23	R21				
	R4	R5	R2	TA2	R24	R22				
	R5	R4	R3	TA3	R25	R23				
	R6	R3	R4	TA4	R26	R24				
	R7	R2	R5	TA5	R27	R25				
	G2	G7	G0	TA6	G22	G20				
	G3	G6	G1	TB0	G23	G21	DTB- DTB+	→		
	G4	G5	G2	TB1	G24	G22				
	G5	G4	G3	TB2	G25	G23				
	G6	G3	G4	TB3	G26	G24				
	G7	G2	G5	TB4	G27	G25				
	B2	B7	B0	TB5	B22	B20				
	B3	B6	B1	TB6	B23	B21				
	B4	B5	B2	TC0	B24	B22	DTC- DTC+	→		
	B5	B4	B3	TC1	B25	B23				
	B6	B3	B4	TC2	B26	B24				
	B7	B2	B5	TC3	B27	B25				
	Hsync	Hsync	Hsync	TC4	HSYNC	HSYNC				
	Vsync	Vsync	Vsync	TC5	VSYNC	VSYNC				
DE	DE	DE	TC6	DE	DE					
R0	R1	R6	TD0	R20	R26	DTD- DTD+	→			
R1	R0	R7	TD1	R21	R27					
G0	G1	G6	TD2	G20	G26					
G1	G0	G7	TD3	G21	G27					
B0	B1	B6	TD4	B20	B26					
B1	B0	B7	TD5	B21	B27					
N.C.	N.C.	N.C.	TD6	-	-					
CLK	CLK	CLK	CLK	CLK	CLK	DTCLK- DTCLK+	→	6 5	CKD- CKD+	

Note1: "H" must be "OPEN".

PRELIMINARY

4.7 10-bit LOOK UP TABLE FOR GAMMA ADJUSTMENT

TBD

4.8 DISPLAY COLORS AND INPUT DATA SIGNALS

This product can display in equivalent to 16,777,216 colors in 256 scale. Also the relation between display colors and input data signals is as the following table.

Display colors		Data signal (0: Low level, 1: High level)																							
		RA7 RA6 RA5 RA4 RA3 RA2 RA1 RA0								GA7 GA6 GA5 GA4 GA3 GA2 GA1 GA0								BA7 BA6 BA5 BA4 BA3 BA2 BA1 BA0							
		RB7 RB6 RB5 RB4 RB3 RB2 RB1 RB0								GB7 GB6 GB5 GB4 GB3 GB2 GB1 GB0								BB7 BB6 BB5 BB4 BB3 BB2 BB1 BB0							
		RC7 RC6 RC5 RC4 RC3 RC2 RC1 RC0								GC7 GC6 GC5 GC4 GC3 GC2 GC1 GC0								BC7 BC6 BC5 BC4 BC3 BC2 BB1 BB0							
		RD7 RD6 RD5 RD4 RD3 RD2 RD1 RD0								GD7 GD6 GD5 GD4 GD3 GD2 GD1 GD0								BD7 BD6 BD5 BD4 BD3 BD2 BD1 BD0							
Basic colors	Black	0	0	0	0	0	0	0	0	0	0	0	0	0	0	0	0	0	0	0	0	0	0	0	0
	Blue	0	0	0	0	0	0	0	0	0	0	0	0	0	0	0	0	1	1	1	1	1	1	1	1
	Red	1	1	1	1	1	1	1	1	0	0	0	0	0	0	0	0	0	0	0	0	0	0	0	0
	Magenta	1	1	1	1	1	1	1	1	0	0	0	0	0	0	0	0	1	1	1	1	1	1	1	1
	Green	0	0	0	0	0	0	0	0	1	1	1	1	1	1	1	1	0	0	0	0	0	0	0	0
	Cyan	0	0	0	0	0	0	0	0	1	1	1	1	1	1	1	1	1	1	1	1	1	1	1	1
	Yellow	1	1	1	1	1	1	1	1	1	1	1	1	1	1	1	1	0	0	0	0	0	0	0	0
	White	1	1	1	1	1	1	1	1	1	1	1	1	1	1	1	1	1	1	1	1	1	1	1	1
Red grayscale	Black	0	0	0	0	0	0	0	0	0	0	0	0	0	0	0	0	0	0	0	0	0	0	0	0
		0	0	0	0	0	0	0	1	0	0	0	0	0	0	0	0	0	0	0	0	0	0	0	0
	dark	0	0	0	0	0	0	1	0	0	0	0	0	0	0	0	0	0	0	0	0	0	0	0	0
	↑	:	:	:	:	:	:	:	:	:	:	:	:	:	:	:	:	:	:	:	:	:	:	:	
	↓	:	:	:	:	:	:	:	:	:	:	:	:	:	:	:	:	:	:	:	:	:	:	:	
	bright	1	1	1	1	1	1	0	1	0	0	0	0	0	0	0	0	0	0	0	0	0	0	0	0
Red	1	1	1	1	1	1	1	0	0	0	0	0	0	0	0	0	0	0	0	0	0	0	0	0	
Red	1	1	1	1	1	1	1	1	0	0	0	0	0	0	0	0	0	0	0	0	0	0	0	0	
Green grayscale	Black	0	0	0	0	0	0	0	0	0	0	0	0	0	0	0	0	0	0	0	0	0	0	0	0
		0	0	0	0	0	0	0	0	0	0	0	0	0	0	0	1	0	0	0	0	0	0	0	0
	dark	0	0	0	0	0	0	0	0	0	0	0	0	0	0	1	0	0	0	0	0	0	0	0	0
	↑	:	:	:	:	:	:	:	:	:	:	:	:	:	:	:	:	:	:	:	:	:	:	:	
	↓	:	:	:	:	:	:	:	:	:	:	:	:	:	:	:	:	:	:	:	:	:	:	:	
	bright	0	0	0	0	0	0	0	0	1	1	1	1	1	1	0	1	0	0	0	0	0	0	0	0
Green	0	0	0	0	0	0	0	0	1	1	1	1	1	1	1	0	0	0	0	0	0	0	0	0	
Green	0	0	0	0	0	0	0	0	1	1	1	1	1	1	1	1	0	0	0	0	0	0	0	0	
Blue grayscale	Black	0	0	0	0	0	0	0	0	0	0	0	0	0	0	0	0	0	0	0	0	0	0	0	0
		0	0	0	0	0	0	0	0	0	0	0	0	0	0	0	0	0	0	0	0	0	0	0	1
	dark	0	0	0	0	0	0	0	0	0	0	0	0	0	0	0	0	0	0	0	0	0	0	1	0
	↑	:	:	:	:	:	:	:	:	:	:	:	:	:	:	:	:	:	:	:	:	:	:	:	
	↓	:	:	:	:	:	:	:	:	:	:	:	:	:	:	:	:	:	:	:	:	:	:	:	
	bright	0	0	0	0	0	0	0	0	0	0	0	0	0	0	0	0	1	1	1	1	1	1	0	1
Blue	0	0	0	0	0	0	0	0	0	0	0	0	0	0	0	0	1	1	1	1	1	1	1	0	
Blue	0	0	0	0	0	0	0	0	0	0	0	0	0	0	0	0	1	1	1	1	1	1	1	1	

4.9 DISPLAY POSITIONS

D(0, 0)	D(1, 0)	...	D(2047,0)
D(0, 1)	D(1, 1)	...	D(2047,1)
•	•	•	•
•	•	•	•
•	•	•	•
•	•	•	•
•	•	•	•
•	•	•	•
•	•	•	•
D(0,1535)	D(1,1535)	...	D(2047,1535)

4.10 PIXEL ARRANGMENT

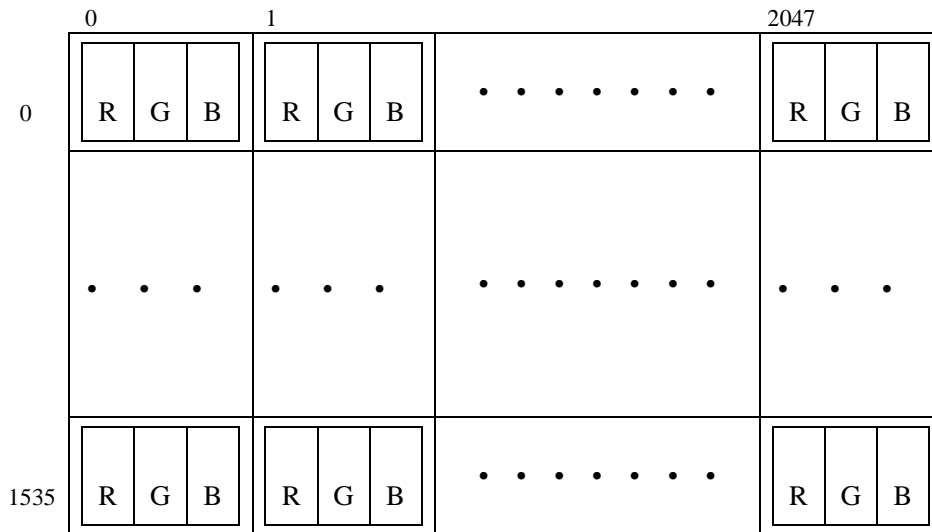

4.11 LVDS DATA TRANSMISSION METHOD

2

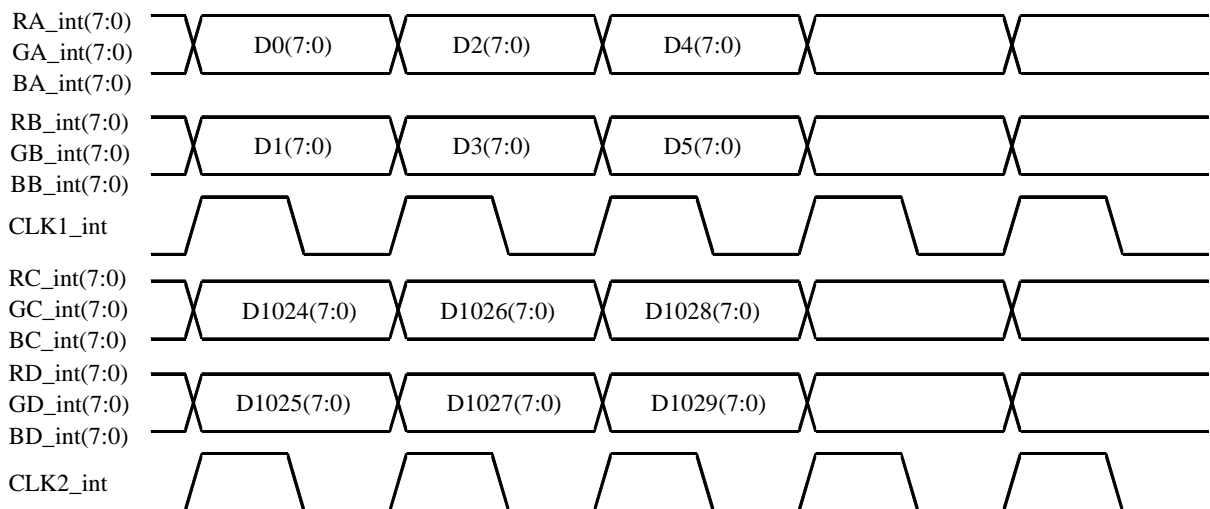

4.12 INPUT SIGNAL TIMINGS FOR LCD PANEL SIGNAL PROCESSING BOARD

4.12.1 Input signal specifications

2

Parameter		Symbol	min.	typ.	max.	Unit	Remarks
CLK1 CLK2	Frequency	1/ tc	TBD -	65.00 15.38	TBD -	MHz ns	-
	Duty	-	Note1			-	-
	Rise, fall	-				ns	-
DE1 DE2	Horizontal Period	th	TBD TBD	10.339 672	TBD TBD	μs CLK	typ.=96.72kHz
	Horizontal Display period	thd	512			CLK	-
	Vertical Period	tv	TBD TBD	16.667 1612	TBD TBD	ms H	typ.=60.0Hz
	Vertical Display period	tvd	1536			H	-
	CLK-DE set-up	-	Note1			ns	-
	CLK-DE hold	-				ns	-
	Raise,fall	-				ns	-
DATA (A) to (D)	CLK-DATA set-up	-	Note1			ns	-
	CLK-DATA hold	-				ns	-
	Rise, fall	-				ns	-

Note1: Timing specifications are defined by the input signals of LVDS transmitter.

THC63LVD823 (THine) or equivalent products are recommended for LVDS transmitter.

Note2: Both of “time” and “CLK number” of the “th” must keep the Minimum value of specification.

Note3: During operation, fluctuation of Hsync period must not exceed ±1 CLK. Otherwise function errors will occur in LCD module.

e.g.: Acceptable fluctuation range is 699-701 CLK, when the Hsync period is 700 CLK.

4.12.2 Input signals timing chart

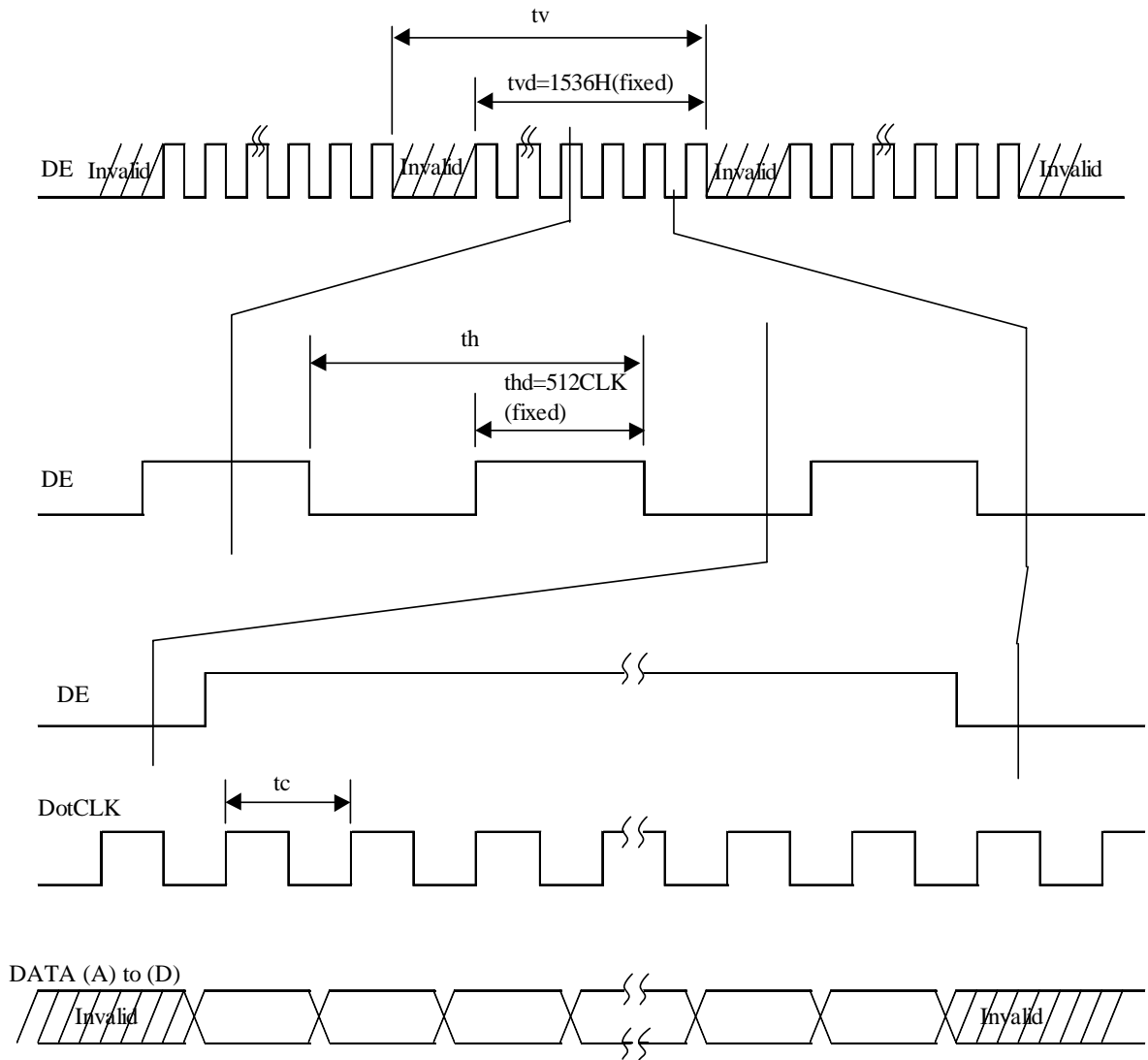

4.13 OPTICS

4.13.1 Optical characteristics

Parameter	Note1	Condition	Symbol	min.	typ.	max.	Unit	Remarks
Luminance		White at center $\theta R = 0^\circ, \theta L = 0^\circ, \theta U = 0^\circ, \theta D = 0^\circ$	L	TBD	235	-	cd/m ²	-
Contrast ratio		White/Black at center $\theta R = 0^\circ, \theta L = 0^\circ, \theta U = 0^\circ, \theta D = 0^\circ$	CR	TBD	500	-	-	Note2
Luminance uniformity		-	LU	-	TBD	1.3	-	Note3
Chromaticity	White	x coordinate	Wx	-	(0.313)	-	-	Note4
		y coordinate	Wy	-	(0.319)	-	-	
	Red	x coordinate	Rx	-	TBD	-	-	
		y coordinate	Ry	-	TBD	-	-	
	Green	x coordinate	Gx	-	TBD	-	-	
		y coordinate	Gy	-	TBD	-	-	
Blue	x coordinate	Bx	-	TBD	-	-		
	y coordinate	By	-	TBD	-	-		
Color gamut		$\theta R = 0^\circ, \theta L = 0^\circ, \theta U = 0^\circ, \theta D = 0^\circ$ at center, against NTSC color space	C	TBD	72	-	%	
Response time		Black to White	Ton	-	TBD	TBD	ms	Note5 Note6
		White to Black	Toff	-	TBD	TBD	ms	
Viewing angle	Right	$\theta U = 0^\circ, \theta D = 0^\circ, CR = 10$	θR	(70)	85	-	°	Note7
	Left	$\theta U = 0^\circ, \theta D = 0^\circ, CR = 10$	θL	(70)	85	-	°	
	Up	$\theta R = 0^\circ, \theta L = 0^\circ, CR = 10$	θU	(70)	85	-	°	
	Down	$\theta R = 0^\circ, \theta L = 0^\circ, CR = 10$	θD	(70)	85	-	°	

Note1: Measurement conditions are as follows.

Ta = 25°C, VDD = 12V, IBL = 6.5mArms/lamp, Display mode: QXGA, Horizontal cycle = 95.34kHz, Vertical cycle = 60.0Hz

Optical characteristics are measured at luminance saturation after 20minutes from working the product, in the dark room. Also measurement method for luminance is as follows.

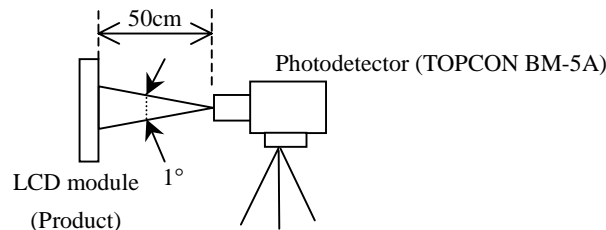

Note2: See "4.13.2 Definition of contrast ratio".

Note3: See "4.13.3 Definition of luminance uniformity".

Note4: These coordinates are found on CIE 1931 chromaticity diagram.

Note5: Product surface temperature: TopF = TBD°C

Note6: See "4.13.4 Definition of response times".

Note7: See "4.13.5 Definition of viewing angles".

4.13.2 Definition of contrast ratio

The contrast ratio is calculated by using the following formula.

$$\text{Contrast ratio (CR)} = \frac{\text{Luminance of white screen}}{\text{Luminance of black screen}}$$

4.13.3 Definition of luminance uniformity

The luminance uniformity is calculated by using following formula.

$$\text{Luminance uniformity (LU)} = \frac{\text{Maximum luminance from ① to ⑤}}{\text{Minimum luminance from ① to ⑤}}$$

The luminance is measured at near the 5 points shown below.

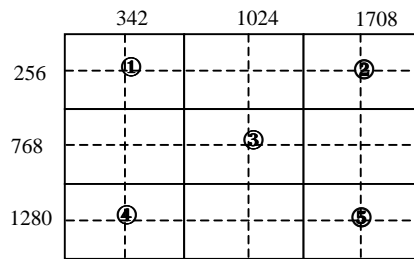

4.13.4 Definition of response times

Response time is measured, the luminance changes from "black" to "white", or "white" to "black" on the same screen point, by photo-detector. Ton is the time it takes the luminance change from 10% up to 90%. Also Toff is the time it takes the luminance change from 90% down to 10% (See the following diagram.).

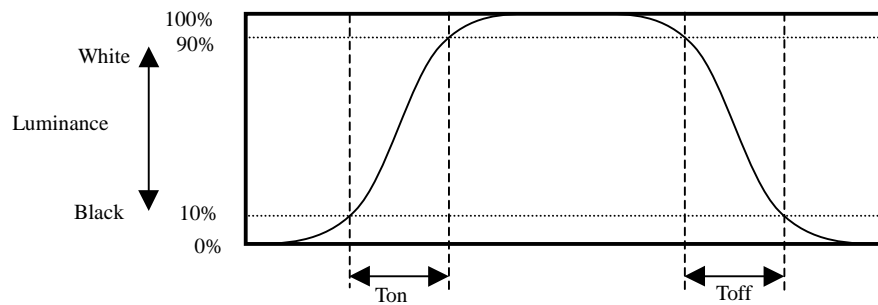

4.13.5 Definition of viewing angles

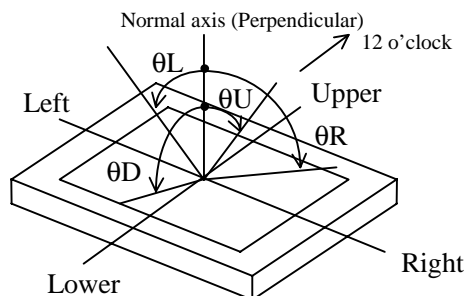

5. RELIABILITY TESTS

Test item	Condition	Judgment	Note1
High temperature and humidity (Operation)	① $60 \pm 2^{\circ}\text{C}$, RH = 60%, 240hours ② Display data is white.	No display malfunctions	
Heat cycle (Operation)	① $0 \pm 3^{\circ}\text{C}$...1hour $55 \pm 3^{\circ}\text{C}$...1hour ② 50cycles, 4hours/cycle ③ Display data is white.		
Thermal shock (Non operation)	① $-20 \pm 3^{\circ}\text{C}$...30minutes $60 \pm 3^{\circ}\text{C}$...30minutes ② 100cycles, 1hour/cycle ③ Temperature transition time is within 5 minutes.		
Vibration (Non operation)	① 5 to 100Hz, 11.76m/s^2 ② 1 minute/cycle ③ X, Y, Z direction ④ 10 times each directions	No display malfunctions No physical damages	
Mechanical shock (Non operation)	① 294m/s^2 , 11ms ② X, Y, Z direction ③ 3 times each directions		
ESD (Operation)	① 150pF, 150Ω , $\pm 10\text{kV}$ ② 9 places on a panel surface Note2 ③ 10 times each places at 1 sec interval	No display malfunctions	
Dust (Operation)	① Sample dust: No.15 (by JIS-Z8901) ② 15 seconds stir ③ 8 times repeat at 1 hour interval		
Low pressure	operation		
	non-operation	① 15 kPa ② $-20^{\circ}\text{C} \pm 3^{\circ}\text{C}$...24 hours ③ $60^{\circ}\text{C} \pm 3^{\circ}\text{C}$...24 hours	

Note1: Display and appearance are checked under environmental conditions equivalent to the inspection conditions of defect criteria.

Note2: See the following figure for discharge points

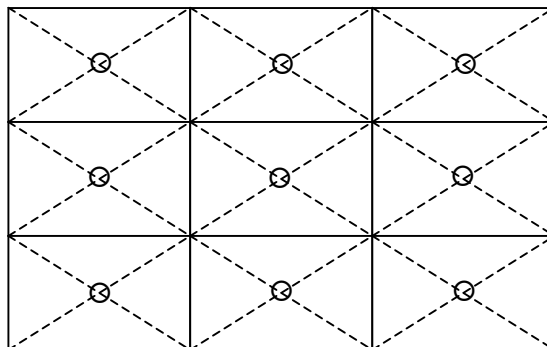

6. PRECAUTIONS

6.1 MEANING OF CAUTION SIGNS

The following caution signs have very important meaning. **Be sure to read "6.2 CAUTIONS" and "6.3 ATTENTIONS", after understanding this contents!**



This sign has the meaning that customer will be injured by himself or the product will sustain a damage, if customer has wrong operations.



This sign has the meaning that customer will get an electrical shock, if customer has wrong operations.



This sign has the meaning that customer will be injured by himself, if customer has wrong operations.

6.2 CAUTIONS



*** Do not touch the working backlight. Customer will be in danger of an electric shock.**



*** Do not touch the working backlight. Customer will be in danger of burn injury.
* Do not shock and press the LCD panel and the backlight! There is a danger of breaking, because they are made of glass. (Shock: To be not greater 294m/s² and to be not greater 11ms, Pressure: To be not greater TBD N)**

6.3 ATTENTIONS



6.3.1 Handling of the product

- ① Take hold of both ends without touch the circuit board cover when customer pulls out products (LCD modules) from inner packing box. If customer touches it, products may be broken down or out of adjustment, because of stress to mounting parts.
- ② Do not hook cables nor pull connection cables such as lamp cable and so on, for fear of damage.
- ③ If customer puts down the product temporarily, the product puts on flat subsoil as a display side turns down.
- ④ Take the measures of electrostatic discharge such as earth band, ionic shower and so on, when customer deals with the product, because products may be damaged by electrostatic.
- ⑤ The torque for mounting screws must never exceed TBD N·m. Higher torque values might result in distortion of the bezel.
- ⑥ The product must be installed using mounting holes without undue stress such as bends or twist (See outline drawings). And do not add undue stress to any portion (such as bezel flat area) except mounting hole portion.
Bends or twist described above and undue stress to any portion except mounting hole portion may cause display un-uniformity.

- ⑦ Do not press or rub on the sensitive display surface. If customer clean on the panel surface, NEC recommends using the cloth with ethanolic liquid such as screen cleaner for LCD.
- ⑧ Do not push-pull the interface connectors while the product is working, because wrong power sequence may break down the product.
- ⑨ Do not bend or unbend the lamp cable at the near part of the lamp holding rubber, to avoid the damage for high voltage side of the lamp. This damage may cause a lamp breaking and abnormal operation of high voltage circuit.

6.3.2 Environment

- ① Do not operate or store in high temperature, high humidity, dewdrop atmosphere or corrosive gases. Keep the product in antistatic pouch in room temperature, because of avoidance for dusts and sunlight, if customer stores the product.
- ② In order to prevent dew condensation occurring by temperature difference, the product packing box must be opened after leave under the environment of an unpacking room temperature enough. Because a situation of dew condensation occurring is changed by the environmental temperature and humidity, evaluate the leaving time sufficiently. (Recommendation leaving time: 6 hour or more with packing state)
- ③ Do not operate in high magnetic field. Circuit boards may be broken down by it.
- ④ This product is not designed as radiation hardened.
- ⑤ Use an original protection sheet on the product surface (polarizer). Adhesive type protection sheet should be avoided, because it may change color or properties of the polarizer.

6.3.3 Characteristics

The following items are neither defects nor failures.

- ① Response time, luminance and color may be changed by ambient temperature.
- ② The LCD may be seemed luminance non-uniformity, flicker, vertical seam or small spot by display patterns.
- ③ Optical characteristics (e.g. luminance, display uniformity, etc.) gradually is going to change depending on operating time, and especially low temperature, because the LCD has cold cathode fluorescent lamps.
- ④ Do not display the fixed pattern for a long time because it may cause image sticking. Use a screen saver, if the fixed pattern is displayed on the screen.
- ⑤ The display color may be changed by viewing angle because of the use of condenser sheet in the backlight.
- ⑥ Optical characteristics may be changed by input signal timings.
- ⑦ The interference noise of input signal frequency for this product's signal processing board and luminance control frequency of customer's backlight inverter may appear on a display. Set up luminance control frequency of backlight inverter so that the interference noise does not appear.

6.3.4 Other

- ① All GND and VDD terminals should be connected without a non-connected signal line.
- ② Do not disassemble a product or adjust volume without permission of NEC.
- ③ Pay attention not to insert waste materials inside of products, if customer uses screwnails.
- ④ Pack the product with original shipping package, because of avoidance of some damages during transportation, when customer returns it to NEC for repair and so on.
- ⑤ Not only the module but also the equipment that used the module should be packed and transported as the module becomes vertical. Otherwise, there is the fear that a display dignity decreases by an impact or vibrations.

7. OUTLINE DRAWINGS

7.1 FRONT VIEW

2

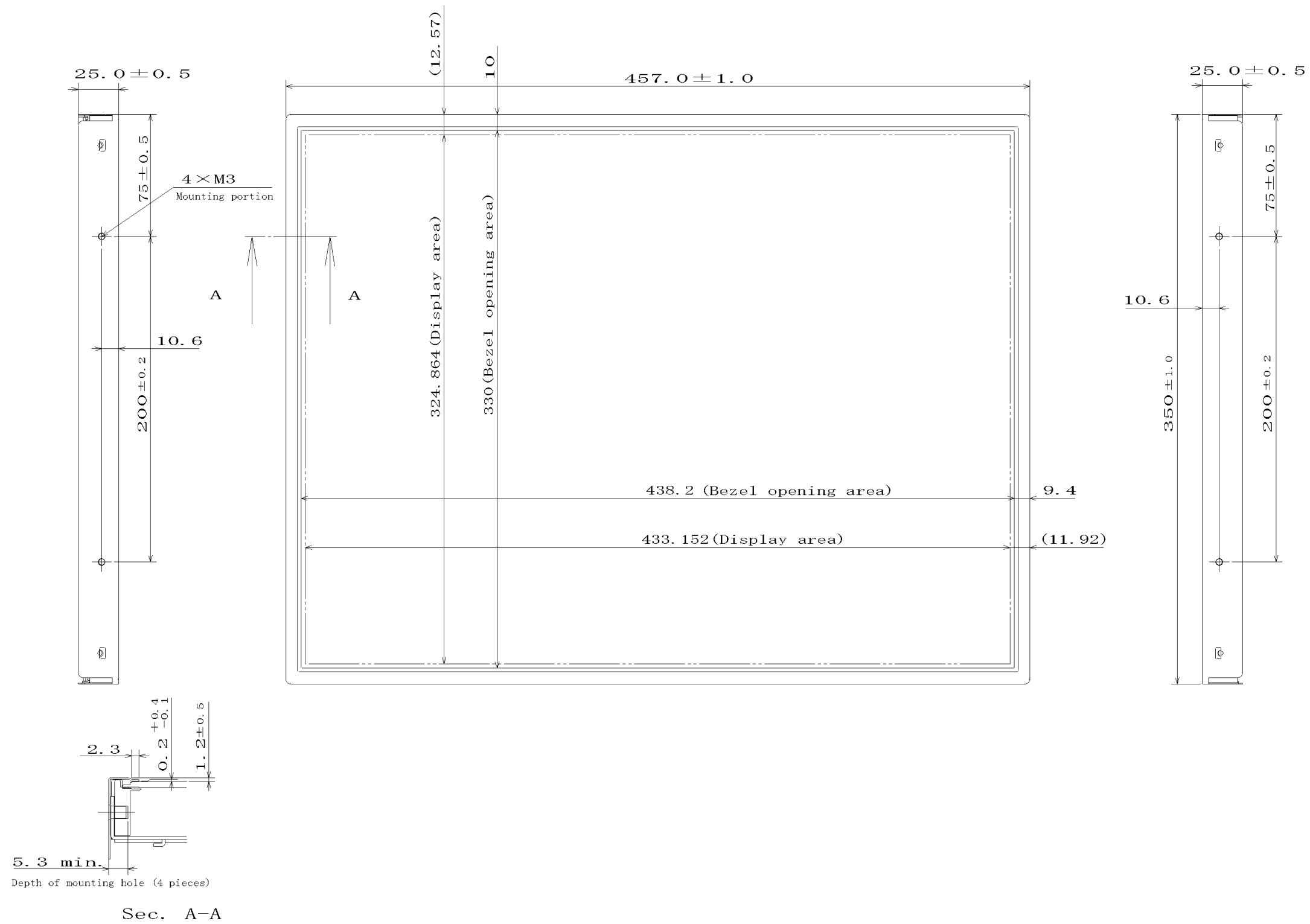

Note1: The torque for mounting screw should never exceed TBD N·m.
 Note2: The values in parentheses are for reference.

Unit: mm

PRELIMINARY

REVISION HISTORY

The inside of latest specifications is revised to the clerical error and the major improvement of previous edition. Only a changed part such as functions, characteristic value and so on that may affect a design of customers, are described especially below.

Edition	Document number	Prepared date	Revision contents and signature
1st edition	DOD-PD-0052	May 15, 2003	<p>Revision contents</p> <p>New issue</p> <p>Signature of writer</p> <p>Approved by _____ T. ITO</p> <p>Checked by _____</p> <p>Prepared by _____ R. KAWASHIMA</p>
2nd edition	DOD-PD-0092	July 4, 2003	<p>Revision contents</p> <p>P9 Driving for backlight lamp- Lamp starting voltage (VS):</p> <ul style="list-style-type: none"> • Ta= 25°C: (1000) Vrms→ (1220) Vrms • Ta= 0°C: (1300) Vrms→ (1460) Vrms <p>P18 "LVDS data transmission method" is added.</p> <p>P19 Input signal specifications are changed.</p> <p>P26 Outline drawings: Front view is changed.</p> <p>Signature of writer</p> <p>Approved by _____ <i>Takihide Ito</i> T. ITO</p> <p>Checked by _____</p> <p>Prepared by _____ <i>R. Kawashima</i> R. KAWASHIMA</p>