

3A Ultra Low-Dropout Linear Regulator

DESCRIPTION

The EUP7963 is a 3A low-dropout linear regulator that provides a low voltage, high current output with a minimum of external components. It offers high precision, ultra-low dropout, and low ground current.

The EUP7963 operates from an input of 2.5V to 5.5V. This regulator uses small, 4.7 μ F ceramic input capacitors and 10 μ F ceramic output capacitors to deliver 3A output current. High bandwidth provides excellent transient response. It is designed to drive digital circuits requiring low voltage at high currents (i.e., PLDs, DSPs, microcontrollers, etc.).

Other features include thermal and current limit protection, a logic-control shutdown mode and an error flag output that goes low when the output voltage drops 10% below nominal value.

It is available in fixed output voltages of 1.5V, 1.8V, 2.5V, 3.3V and as an adjustable device with a 0.8V reference voltage. The adjustable output voltage can be set from 0.8V to 4.5V.

FEATURES

- 3A Guaranteed Output Current
- 750mV Dropout Voltage at 3A Output
- Stable with Ceramic Capacitors
- $\pm 1.8\%$ Output Voltage Accuracy
- 1mA Low-Ground Pin Current
- 0.1 μ A Quiescent Current in Shutdown Mode
- Excellent Line and Load Regulation
- Thermal Shutdown and Current Limit Protection
- Error Flag Indication
- Available in To-263, and To-220 Packages
- RoHS Compliant and 100% Lead (Pb)-Free

APPLICATIONS

- LDO Linear Regulator for Low-Voltage Digital IC
- PC Add-In Cards
- High Efficiency Linear Power Supplies
- Post Regulator

Typical Application Circuit

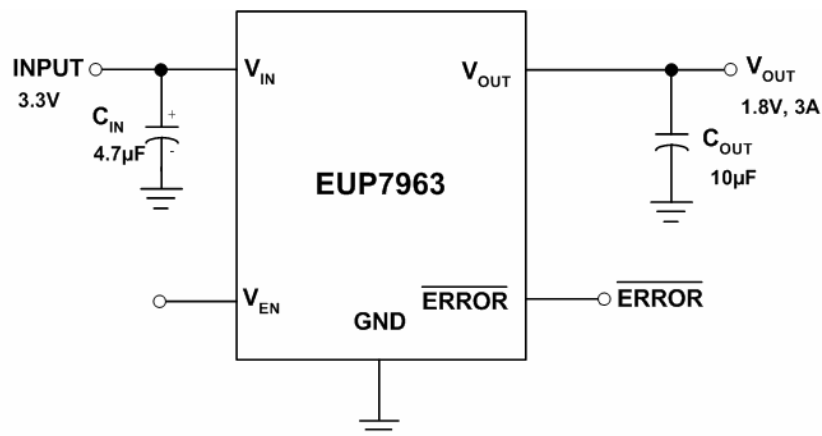

Figure1.

Block Diagram

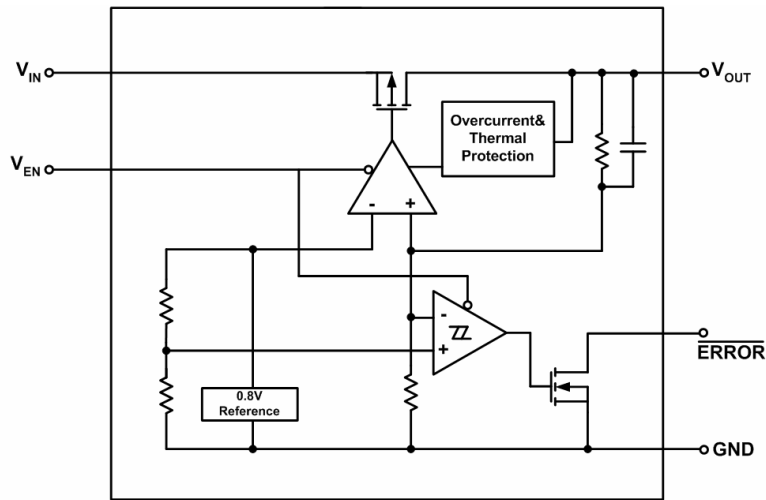

Figure2.



















Pin Configurations

| Package Type | Pin Configurations |
|--------------------|--------------------|
| TO220-3 TO220-5 | |
| TO263-3 TO263-5 | |

Pin Description

| PIN | TO220-5 TO263-5 | TO220-3 TO263-3 | DESCRIPTION |
|------------------|--------------------|--------------------|--|
| V _{EN} | 1 | | Enable Input. Logic high=enable, Logic low=shutdown |
| V _{IN} | 2 | 1 | Input Voltage of the LDO |
| GND | 3 | 2 | Ground: TAB is connected to ground |
| V _{OUT} | 4 | 3 | Output voltage of the LDO |
| ERROR | 5 | | ERROR Flag Output. Active-low indicated an output fault condition |
| ADJ | | | Adjustable Regulator Feedback Input. Connect to resistor voltage divider |

Ordering Information

| Order Number | Package Type | Marking | Operating Temperature range |
|-----------------|--------------|---|-----------------------------|
| EUP7963-15KAIR1 | TO220-3 |  xxxxx P7963C | -40 °C to 125°C |
| EUP7963-18KAIR1 | TO220-3 |  xxxxx P7963D | -40 °C to 125°C |
| EUP7963-25KAIR1 | TO220-3 |  xxxxx P7963B | -40 °C to 125°C |
| EUP7963-33KAIR1 | TO220-3 |  xxxxx P7963H | -40 °C to 125°C |
| EUP7963-15KBIR1 | TO220-5 |  xxxxx P7963C | -40 °C to 125°C |
| EUP7963-18KBIR1 | TO220-5 |  xxxxx P7963D | -40 °C to 125°C |
| EUP7963-25KBIR1 | TO220-5 |  xxxxx P7963B | -40 °C to 125°C |
| EUP7963-33KBIR1 | TO220-5 |  xxxxx P7963H | -40 °C to 125°C |
| EUP7963KBIR1 | TO220-5 |  xxxxx P7963A | -40 °C to 125°C |
| EUP7963-15LAIR1 | TO263-3 |  xxxxx EUP7963C | -40 °C to 125°C |
| EUP7963-18LAIR1 | TO263-3 |  xxxxx EUP7963D | -40 °C to 125°C |
| EUP7963-25LAIR1 | TO263-3 |  xxxxx EUP7963B | -40 °C to 125°C |
| EUP7963-33LAIR1 | TO263-3 |  xxxxx EUP7963H | -40 °C to 125°C |
| EUP7963-15LBIR1 | TO263-5 |  xxxxx EUP7963C | -40 °C to 125°C |
| EUP7963-18LBIR1 | TO263-5 |  xxxxx EUP7963D | -40 °C to 125°C |
| EUP7963-25LBIR1 | TO263-5 |  xxxxx EUP7963B | -40 °C to 125°C |
| EUP7963-33LBIR1 | TO263-5 |  xxxxx EUP7963H | -40 °C to 125°C |
| EUP7963LBIR1 | TO263-5 |  xxxxx EUP7963A | -40 °C to 125°C |

EUP7963-

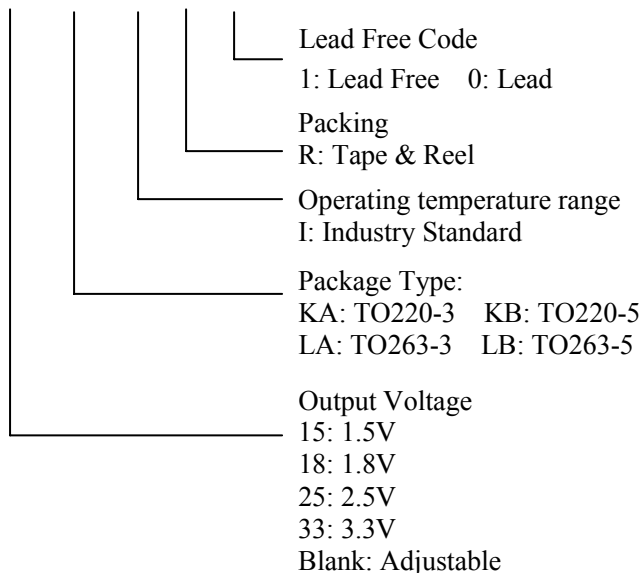

Absolute Maximum Ratings

- Supply Voltage V_{IN} ----- 5.5V
- Package Thermal Resistance
 - TO-263, θ_{JA} ----- 45%/W
 - TO-220, θ_{JA} ----- 55%/W
- Power Dissipation, $PD@TA=25^{\circ}C$
 - TO-263 ----- 2.2W
 - TO-220 ----- 1.8W
- Junction Temperature ----- 150°C
- Storage Temperature ----- -65°C to +150°C
- Lead Temp ----- 260°C
- ESD Rating
 - Human Body Model ----- 2kV

Operating Ratings

- Supply Voltage V_{IN} ----- 2.5 to 5.5V
- Enable Input Voltage ----- 0V to 5.5V
- Junction Temperature ----- -40°C to +125°C

Electrical Characteristics

Limits in standard typeface are for $T_J=25^{\circ}C$. Unless otherwise specified: $V_{IN}=V_{OUT(nom)}+1V$, $I_L=10mA$, $C_{OUT}=10\mu F$

| Symbol | Parameter | Conditions | EUP7963 | | | Unit |
|---------------------------------|---|---|---------|------|------|---------------|
| | | | Min | Typ | Max. | |
| V_{OUT} | Output Voltage Tolerance | $V_{OUT}+1V \leq V_{IN} \leq 5.5V$ $10mA \leq I_L \leq 3A$ | -1.8 | | 1.8 | % |
| | Line Regulation | $V_{OUT}+1V \leq V_{IN} \leq 5.5V$ | | 0.1 | 0.3 | %/ ΔV |
| | Load Regulation | $10mA \leq I_L \leq 3A$ | | 0.15 | 0.3 | %/ ΔA |
| $V_{IN}-V_{OUT}$ | Dropout Voltage | $I_L = 300mA$ | | 50 | | mV |
| | | $I_L = 3A$ | | 750 | | |
| I_{GND} | Ground Pin Current in Normal Operation Mode | $I_L = 0A$ | | 1.0 | 1.5 | mA |
| | | $I_L = 3A$ | | 1.4 | 2.1 | |
| | Ground Pin Current in Shutdown Mode | $V_{EN} \leq 0.3V$ | 0.01 | | 10 | μA |
| $I_{O(PK)}$ | Peak Output Current | $V_O \geq V_{O(NOM)} -4\%$ | | 4.3 | | A |
| Short Circuit Protection | | | | | | |
| I_{SC} | Short Circuit Current | | | 4.6 | | A |

Electrical Characteristics

Limits in standard typeface are for $T_J=25^{\circ}\text{C}$. Unless otherwise specified: $V_{IN}=V_{OUT(nom)}+1\text{V}$, $I_L=10\text{mA}$, $C_{OUT}=10\mu\text{F}$

| Symbol | Parameter | Conditions | EUP7963 | | | Unit |
|------------------------------------|--------------------------------|---|---------|------|------|--------------------|
| | | | Min | Typ | Max. | |
| V_{IH} | Enable Threshold | Output = High | 1.4 | | | V |
| V_{IL} | | Output = Low | | | 0.3 | |
| T_{dOFF} | Turn-off delay | $I_L = 3\text{A}$ | | 15 | | μs |
| T_{dON} | Turn-on delay | $I_L = 3\text{A}$ | | 20 | | |
| I_{EN} | V_{EN} Pin Input Current | $V_{EN}=V_{IN}$ | | 0.1 | 1 | μA |
| ERROR Flag | | | | | | |
| V_T | Threshold | | 7 | 10 | 14 | % |
| V_{TH} | Threshold Hysteresis | | 3 | 5 | 8 | % |
| $V_{EF(Sat)}$ | ERROR Flag Saturation | $I_{SINK}=100\mu\text{A}$ | | 0.02 | 0.2 | V |
| T_d | Flag Reset Delay | | | 1 | | μs |
| I_{IK} | ERROR Flag Pin Leakage Current | | | 1 | | nA |
| I_{max} | ERROR Flag Pin Sink Current | $V_{Error}=0.5\text{V}$ | | 3 | | mA |
| AC Parameters | | | | | | |
| PSRR | Ripple Rejection | $V_{IN}=V_{OUT}+1\text{V}$ $C_{OUT}=10\mu\text{F}$ $V_{OUT}=3.3\text{V}$, $f=120\text{Hz}$ | | 56 | | dB |
| e_n | Output Noise Voltage | $\text{BW}=10\text{Hz}-100\text{kHz}$ $V_{OUT}=2.5\text{V}$ | | 200 | | $\mu\text{V(rms)}$ |
| Over Temperature Protection | | | | | | |
| $T_{SH(t)}$ | Shutdown Threshold | | | 150 | | $^{\circ}\text{C}$ |
| $T_{SH(h)}$ | Thermal Shutdown Hysteresis | | | 15 | | $^{\circ}\text{C}$ |

Typical Operating Characteristics

Drop-Out Voltage Vs Temperature for Different Load Currents

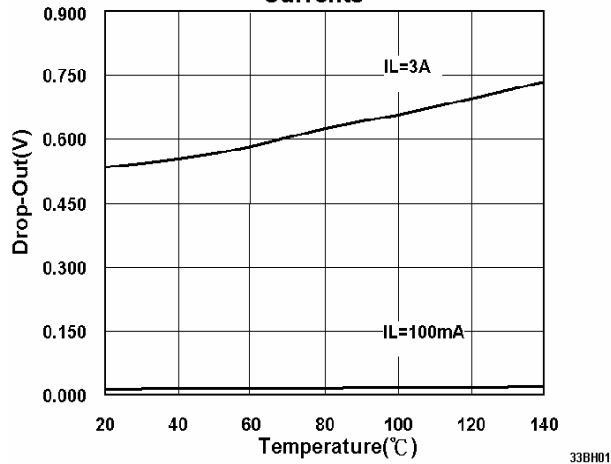

33BH01

Load Transient Response

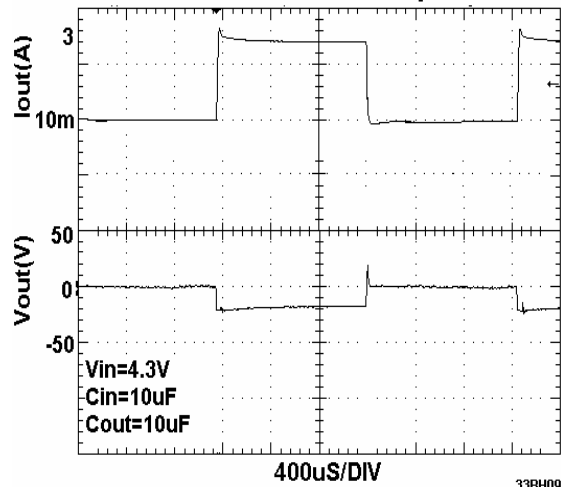

33BH09

Ground Pin Current Vs Input Voltage (VSD=VIN)

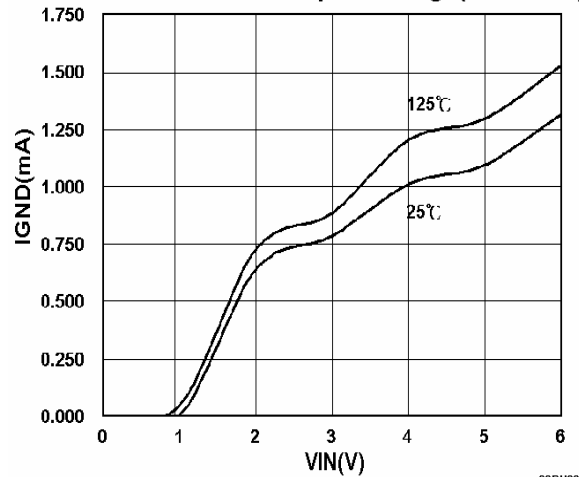

33BH02

Input Voltage Vs Output Voltage

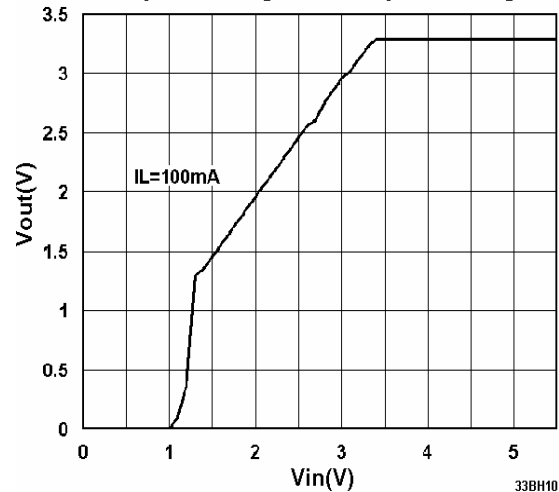

33BH10

Ground Current Vs Temperature (VSD=VIN)

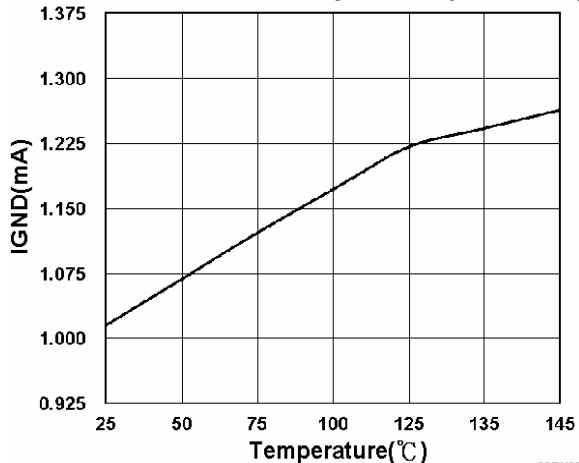

33BH03

PSRR OUTPUT

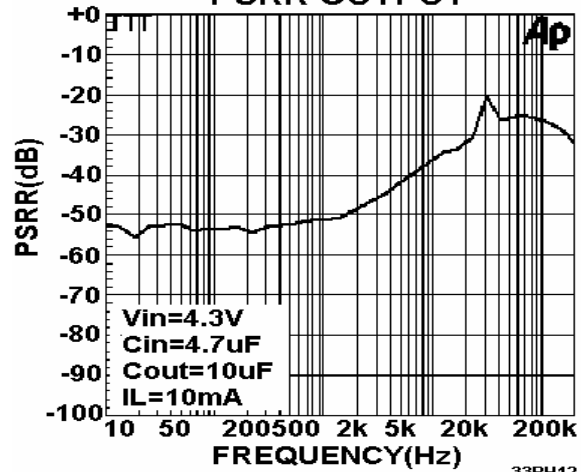

33BH12

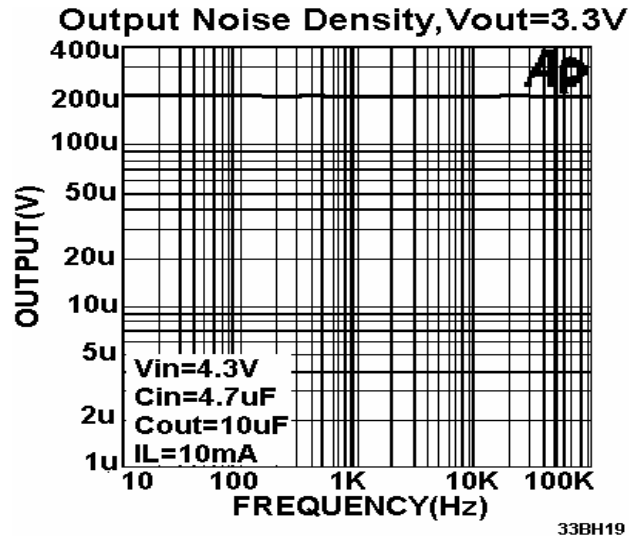
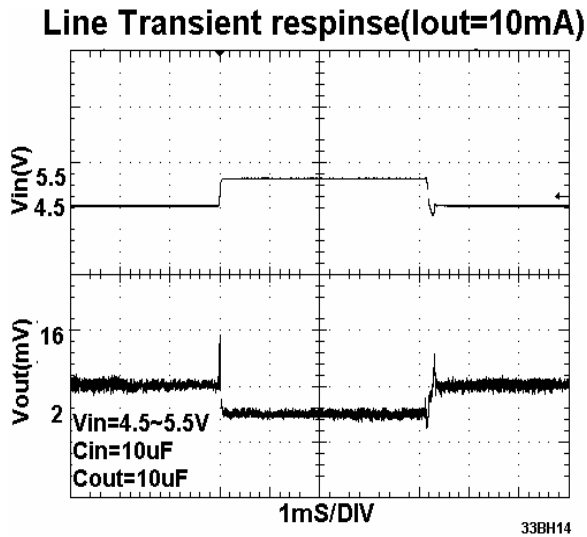
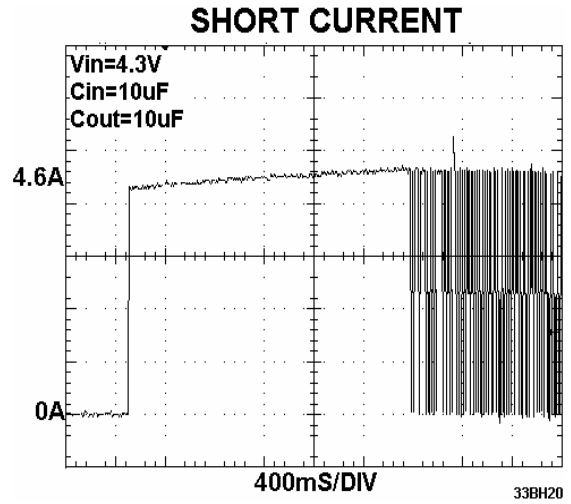
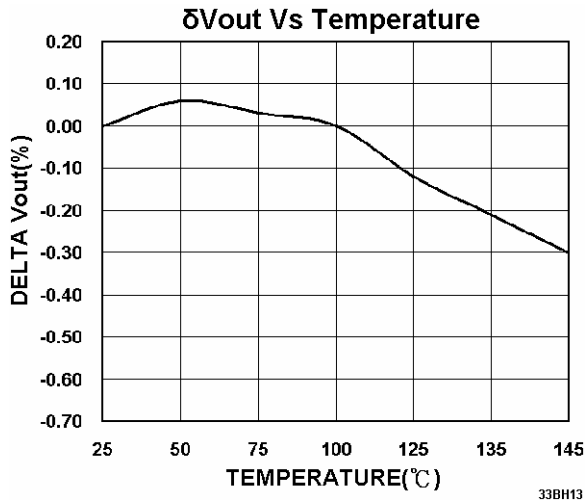

Application Note

External Capacitors

Like any low-dropout regulator, the EUP7963 requires external capacitors for regulator stability. These capacitors must be correctly selected for good performance.

Input Capacitor

An input capacitance of 4.7µF is required between the EUP7963 input pin and ground (the amount of the capacitance may be increased without limit).

This capacitor must be located a distance of not more than 1cm from the input pin and returned to a clean analog ground. Any good quality ceramic, tantalum, or film capacitor may be used at the input.

If a tantalum capacitor is used at the input, it must be guaranteed by the manufacturer to have a surge current rating sufficient for the application.

There are no requirements for the ESR on the input capacitor, but tolerance and temperature coefficient must be considered when selecting the capacitor to ensure the capacitance will be 4.7µF over the entire operating temperature range.

Output Capacitor

The EUP7963 is designed specifically to work with very small ceramic output capacitors. A ceramic capacitor (temperature characteristics X7R, X5R, Z5U, or Y5V) in 10 to 22µF range with 5mΩ to 200mΩ ESR range is suitable in the EUP7963 application circuit.

The output capacitor must meet the requirement for minimum amount of capacitance and also have an ESR (Equivalent Series Resistance) value which is within a stable range (5mΩ to 200mΩ)

No-Load Stability

The EUP7963 will remain stable and in regulation with no external load. This is specially important in CMOS RAM keep-alive applications.

On/Off Input Operation

The EUP7963 is turned off by pulling the V_{EN} pin low, and turned on by pulling it high. If this feature is not used, the V_{EN} pin should be tied to V_{IN} to keep the regulator output on at all time. To assure proper operation, the signal source used to drive the V_{EN} input must be able to swing above and below the specified turn-on/off voltage thresholds listed in the Electrical Characteristics section under V_{IL} and V_{IH}.

ERROR Flag Operation

The EUP7963 produces a logic low signal at the ERROR Flag pin when the output drops out of regulation due to low input voltage, current limiting, or thermal limiting. This flag has a built in hysteresis.

The internal ERROR flag comparator has an open drain output stage. Hence, the ERROR pin should be pulled high through a pull up resistor. The ERROR pin must be connected to ground if this function is not used. It should also be noted that when the shutdown pin is pulled low, the ERROR pin is forced to be invalid for reasons of saving power in shutdown mode.

Adjustable Operation

The adjustable version of the EUP7963 has an output voltage range of 0.8V to 4.5V. The output voltage of the EUP7963 adjustable regulator is programmed using an external resistor divider as shown in Figure3. The output voltage is calculated using:

$$V_O = V_{ref} \times \left(1 + \frac{R_1}{R_2}\right)$$

Where:

V_{ref}= 0.8V typ. (the internal reference voltage)

Utilize the following equation for adjusting the output to a particular voltage:

$$P_I = R_2 \left[\frac{V_O}{0.8V} - 1 \right]$$

Choose R₂=50k to optimize accuracy, power supply rejection, noise and power consumption.

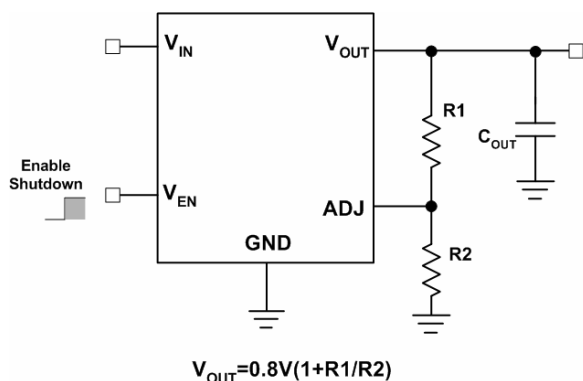

Figure3. Adjustable Regulator with Resistors

Power Dissipation

EUP7963 can deliver a continuous current of 2A over the full operating temperature range. A heatsink may be required depending on the maximum power dissipation and maximum ambient temperature of the application. Under all possible conditions, the junction temperature must be within the range specified under operating conditions. The total power dissipation of the device is given by:

$$P_D = (V_{IN} - V_{OUT})I_{OUT} + (V_{IN})I_{GND}$$

Where I_{GND} is the operating ground current of the device (specified under Electrical Characteristics).

The maximum allowable temperature rise (T_{Rmax}) depends on the maximum ambient temperature (T_{Amax}) of the application, and the maximum allowable junction temperature (T_{Jmax}):

$$T_{Rmax} = T_{Jmax} - T_{Amax}$$

The maximum allowable value for junction to ambient Thermal Resistance, θ_{JA} , can be calculated using the formula:

$$\theta_{JA} = T_{Rmax} / P_D$$

PCB Layout

Good PC layout practices must be used or instability can be induced because of ground loops and voltages drops. The input and output capacitors must be directly connected to the input, output, and ground pins of the regulator using traces which do not have other currents flowing in them.

The best way to do this is to lay out C_{IN} and C_{OUT} near the device with short traces to the V_{IN} , V_{OUT} , and ground pins. The regulator ground pin should be connected to the external circuit ground so that the regulator and its capacitors have a “single point ground”.

It should be noted that stability problems have been seen in applications where “vias” to an internal ground plane were used at the ground points of the IC and the input and output capacitors. This was caused by varying ground potentials at these nodes resulting from current flowing through the ground plane. Using a single point ground technique for the regulator and its capacitors fixed the problem.

Since high current flows through the traces going into V_{IN} and coming from V_{OUT} , Kelvin connect the capacitor leads to these pins so there is no voltage drop in series with the input and output capacitors.

Packaging Information

TO263-3

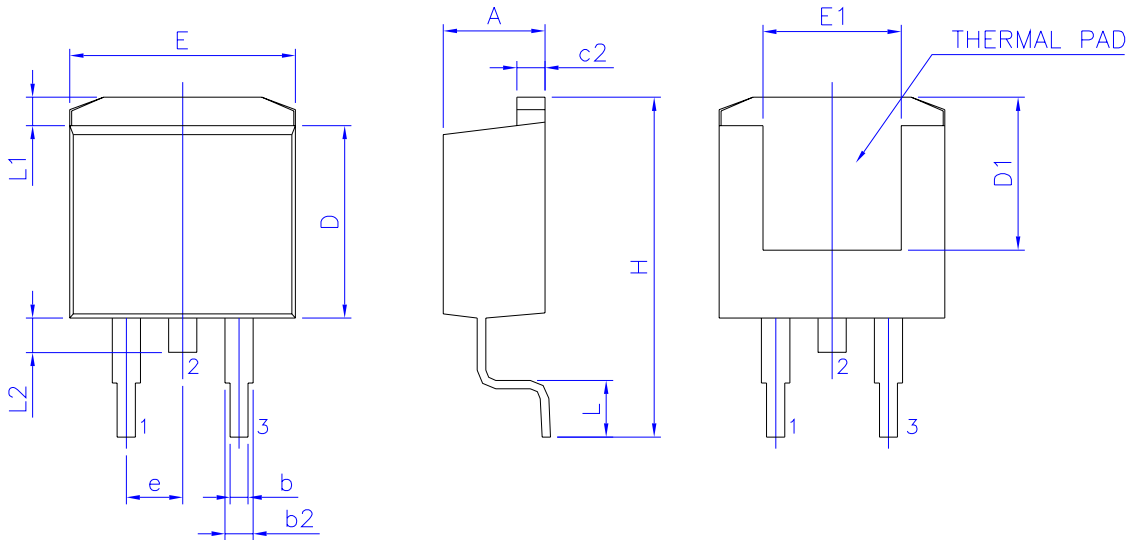

| SYMBOLS | MILLIMETERS | | INCHES | |
|---------|-------------|-------|--------|-------|
| | MIN. | MAX. | MIN. | MAX. |
| A | 4.06 | 4.83 | 0.160 | 0.190 |
| C2 | 1.14 | 1.65 | 0.045 | 0.065 |
| b | 0.51 | 1.00 | 0.020 | 0.039 |
| b1 | 1.14 | 1.40 | 0.045 | 0.055 |
| D | 8.38 | 9.65 | 0.330 | 0.380 |
| E | 9.65 | 10.67 | 0.380 | 0.420 |
| e | 2.54 | | 0.100 | |
| H | 14.60 | 15.88 | 0.575 | 0.625 |
| L2 | - | 1.78 | - | 0.070 |
| L | 1.78 | 2.80 | 0.070 | 0.110 |
| L1 | - | 1.68 | - | 0.066 |
| D1 | 6.86 | - | 0.270 | - |
| E1 | 6.22 | - | 0.245 | - |

TO263-5

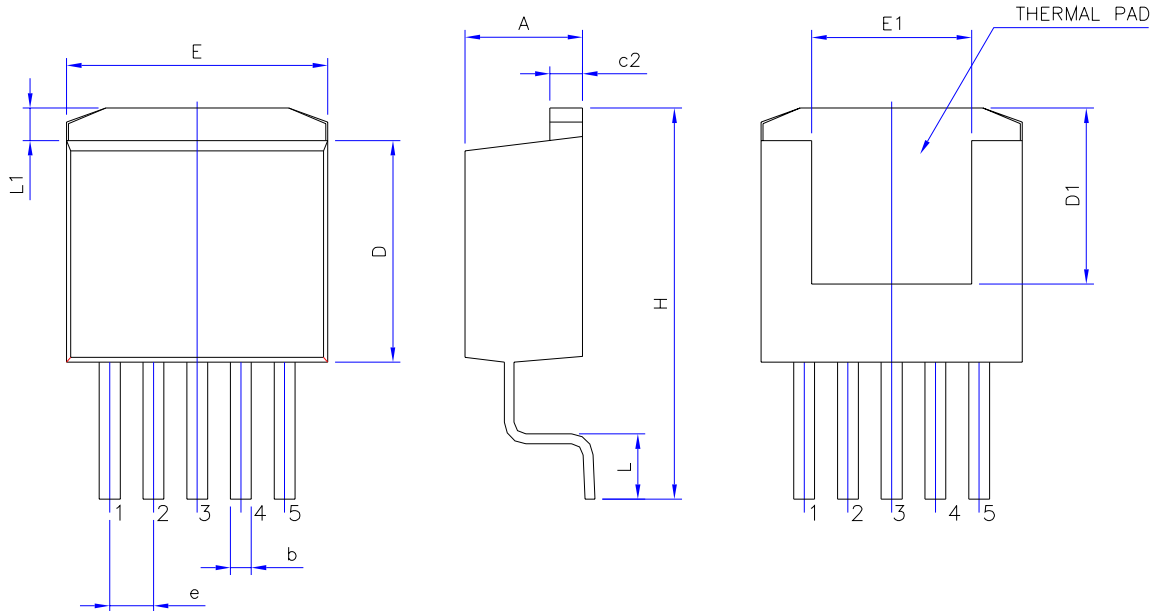

| SYMBOLS | MILLIMETERS | | INCHES | |
|---------|-------------|-------|--------|-------|
| | MIN. | MAX. | MIN. | MAX. |
| A | 4.06 | 4.83 | 0.160 | 0.190 |
| C2 | 1.14 | 1.65 | 0.045 | 0.065 |
| b | 0.51 | 1.00 | 0.020 | 0.039 |
| D | 8.38 | 9.65 | 0.330 | 0.380 |
| E | 9.65 | 10.67 | 0.380 | 0.420 |
| e | 1.70 | | 0.067 | |
| H | 14.60 | 15.88 | 0.575 | 0.625 |
| L | 1.78 | 2.80 | 0.070 | 0.110 |
| L1 | - | 1.68 | - | 0.066 |
| D1 | 6.86 | - | 0.270 | - |
| E1 | 6.22 | - | 0.245 | - |

TO220-3

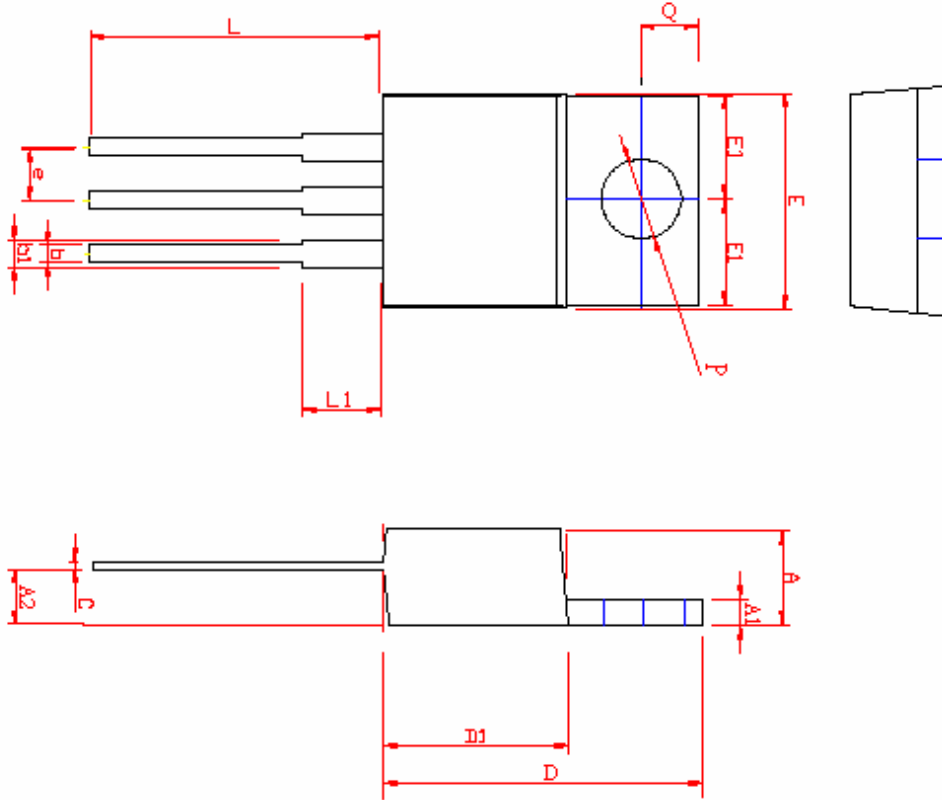

| SYMBOLS | MILLIMETERS | | INCHES | |
|---------|-------------|-------|--------|-------|
| | MIN. | MAX. | MIN. | MAX. |
| A | 4.06 | 4.83 | 0.160 | 0.190 |
| A2 | 2.03 | 2.92 | 0.080 | 0.115 |
| b | 0.64 | 1.02 | 0.025 | 0.040 |
| b1 | 1.14 | 1.52 | 0.045 | 0.060 |
| C | 0.30 | 0.56 | 0.012 | 0.022 |
| D | 13.72 | 15.75 | 0.540 | 0.620 |
| D1 | 7.62 | 9.40 | 0.300 | 0.370 |
| Q | 2.62 | 2.87 | 0.103 | 0.113 |
| E | 9.65 | 10.67 | 0.380 | 0.420 |
| E1 | 4.88 | 5.33 | 0.190 | 0.210 |
| P | 3.71 | 4.00 | 0.146 | 0.156 |
| e | 2.54 | | 0.100 | |
| A1 | 1.14 | 1.40 | 0.045 | 0.055 |
| L | 12.70 | 14.73 | 0.500 | 0.580 |
| L1 | - | 6.35 | - | 0.250 |

TO220-5

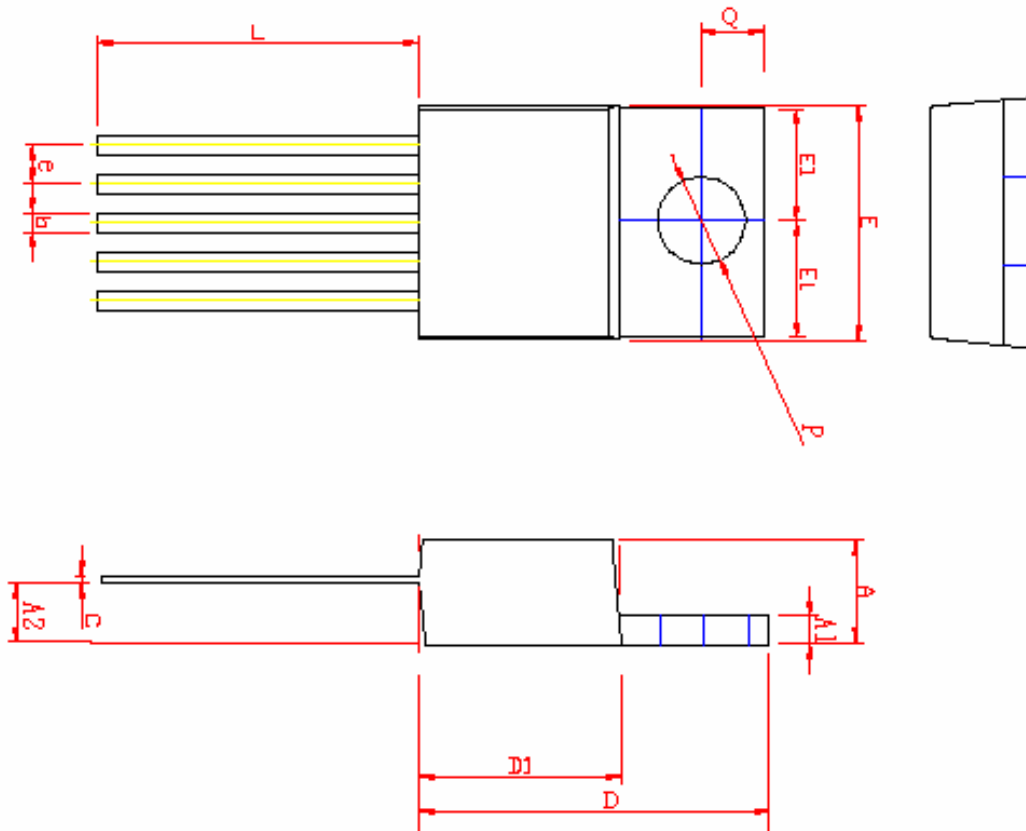

| SYMBOLS | MILLIMETERS | | INCHES | |
|---------|-------------|-------|--------|-------|
| | MIN. | MAX. | MIN. | MAX. |
| A | 4.06 | 4.83 | 0.160 | 0.190 |
| A2 | 2.03 | 2.92 | 0.080 | 0.115 |
| b | 0.64 | 1.02 | 0.025 | 0.040 |
| C | 0.30 | 0.56 | 0.012 | 0.022 |
| D | 13.72 | 15.75 | 6.540 | 0.620 |
| D1 | 7.62 | 9.40 | 0.300 | 0.370 |
| Q | 2.62 | 2.87 | 0.103 | 0.113 |
| E | 9.65 | 10.67 | 0.380 | 0.420 |
| E1 | 4.88 | 5.33 | 0.190 | 0.210 |
| P | 3.71 | 4.00 | 0.146 | 0.156 |
| e | 1.70 | | 0.067 | |
| A1 | 1.14 | 1.40 | 0.045 | 0.055 |
| L | 12.70 | 14.73 | 0.500 | 0.580 |