



**Pb-free
HEAT**



3363K Series

Single Color Semi-Round Shape Type

Features

Package	2 × 3 Semi-Round shape type, MBG,MPG : Pale Green Clear epoxy MPY,MAY : Pale Yellow Clear epoxy MAA : Pale Orange Clear epoxy MVR,BR,MPR : Pale Red Clear epoxy
Product features	<ul style="list-style-type: none"> • Outer Dimension 2 × 3 Semi-Round shape type • Operation temperature range. Storage Temperature : -30°C~100°C Operating Temperature : -30°C~85°C • Lead-free soldering compatible • RoHS compliant
Dominant wavelength	Green : 558nm (MBG) 567nm (MPG) Yellow Green : 572nm (MPY) Yellow : 590nm (MAY) Orange : 606nm (MAA) Red : 624nm (MVR) 647nm (BR) 630nm (MPR)
Half Intensity Angle	MBG : $\theta_x=34$ deg. $\theta_y=31$ deg., MPG $\theta_x=28$ deg. $\theta_y=23$ deg. MPY : $\theta_x=30$ deg. $\theta_y=23$ deg., MAY $\theta_x=36$ deg. $\theta_y=32$ deg. MAA : $\theta_x=39$ deg. $\theta_y=28$ deg., MVR $\theta_x=36$ deg. $\theta_y=28$ deg. BR : $\theta_x=35$ deg. $\theta_y=30$ deg., MPR $\theta_x=35$ deg. $\theta_y=28$ deg.
Die materials	MBG, MPG, MPY, MPR : GaP MAY, MAA, MVR : GaAsP BR : GaAlAs
Rank grouping parameter	Sorted by luminous intensity per rank taping
Soldering methods	TTW (Through The Wave) soldering and manual soldering
ESD	More than 2kV(HBM)
Packing	Bulk : 200pcs(MIN.)

Recommended Applications

Amusement Equipment, Electric Household Appliances, OA/FA, Other General Applications

Color and Luminous Intensity

(Ta=25°C)

Part No.	Material	Emitted Color	Lens Color		Dominant Wavelength λd (nm)		Luminous Intensity Iv (mcd)		
					TYP.	I _F	MIN.	TYP.	I _F
					MBG3363K	GaP	Green	Pale Green	Clear
MPG3363K	GaP	Green	567	20	15	30	20		
MPY3363K	GaP	Yellow Green	Pale Yellow	572	20	30	60	20	
MAY3363K	GaAsP	Yellow		590	20	20	40	20	
MAA3363K	GaAsP	Orange	Pale Orange	606	20	20	40	20	
MVR3363K	GaAsP	Red	Pale Red	624	20	8	16	20	
BR3363K	GaAlAs	Red		647	20	10	20	20	
MPR3363K	GaP	Red		630	10	2	4	10	

Absolute Maximum Ratings

(Ta=25°C)

Item	Symbol	Absolute Maximum Ratings								Unit
		MBG	MPG	MPY	MAY	MAA	MVR	BR	MPR	
Power Dissipation	P_d	70	70	85	85	70	75	100	75	mW
Forward Current	I_F	25	25	30	30	25	30	50	30	mA
Pulse Forward Current ※1	I_{FRM}	60	60	75	75	60	75	300	75	mA
Derating (Ta=25°C or higher)	ΔI_F	0.33	0.33	0.40	0.40	0.33	0.40	0.67	0.40	mA/°C
Reverse Voltage	V_R	4	4	4	4	4	4	4	4	V
Operating Temperature	T_{opr}	-30~+85								°C
Storage Temperature	T_{stg}	-30~+100								°C

 ※1 I_{FRM} Measurement condition : Pulse Width ≤ 1 ms., Duty $\leq 1/20$.

Electro-Optical Characteristics(MBG,MPG,MPY,MAY,MAA,MVR,BR) (Ta=25°C)

Item	Conditions	Symbol	Characteristics								Unit
			MBG	MPG	MPY	MAY	MAA	MVR	BR		
Forward Voltage	I _F =20mA	V _F	TYP.	2.1	2.1	2.1	2.2	2.2	2.0	1.7	V
			MAX.	2.8	2.8	2.8	2.8	2.8	2.8	2.0	
Reverse Current	V _R =4V	I _R	MAX.	20	20	20	20	20	20	100	μ A
Peak Wavelength	I _F =20mA	λ _p	TYP.	555	560	570	580	605	630	660	nm
Dominant Wavelength	I _F =20mA	λ _d	TYP.	558	567	572	590	606	624	647	nm
Spectral Line Half Width	I _F =20mA	Δλ	TYP.	30	30	30	30	30	30	30	nm
Half Intensity Angle	I _F =20mA	2θ 1/2	TYP.	34(θx)	28(θx)	30(θx)	36(θx)	39(θx)	36(θx)	35(θx)	deg.
				31(θy)	23(θy)	23(θy)	32(θy)	28(θy)	28(θy)	30(θy)	

Electro-Optical Characteristics(MPR)

(Ta=25°C)

Item	Conditions	Symbol	Characteristics		Unit
				MPR	
Forward Voltage	I _F =10mA	V _F	TYP.	2.1	V
			MAX.	2.8	
Reverse Current	V _R =4V	I _R	MAX.	20	μ A
Peak Wavelength	I _F =10mA	λ _p	TYP.	700	nm
Dominant Wavelength	I _F =10mA	λ _d	TYP.	630	nm
Spectral Line Half Width	I _F =10mA	Δλ	TYP.	100	nm
Half Intensity Angle	I _F =10mA	2θ 1/2	TYP.	35(θx)	deg.
				28(θy)	

Luminous Intensity Rank

(Ta=25°C)

Rank	I _v (mcd)															
	MBG		MPG		MPY		MAY		MAA		MVR		BR		MPR	
	I _f =20mA		I _f =20mA		I _f =20mA		I _f =20mA		I _f =20mA		I _f =20mA		I _f =20mA		I _f =10mA	
	MIN.	MAX.	MIN.	MAX.	MIN.	MAX.	MIN.	MAX.	MIN.	MAX.	MIN.	MAX.	MIN.	MAX.	MIN.	MAX.
A	8.0	16.0	15	30	30	60	20	40	20	40	8.0	16.0	10	20	2.0	4.0
B	11.2	22.4	21	42	42	84	28	56	28	56	11.2	22.4	14	28	2.8	5.6
C	16.0	32.0	30	60	60	120	40	80	40	80	16.0	32.0	20	40	4.0	8.0
D	22.4	44.8	42	84	84	168	56	112	56	112	22.4	44.8	28	56	5.6	11.2
E	32.0	-	60	-	120	-	80	-	80	-	32.0	-	40	-	8.0	-

Please contact our sales staff concerning rank designation.

Technical Data(MBG)

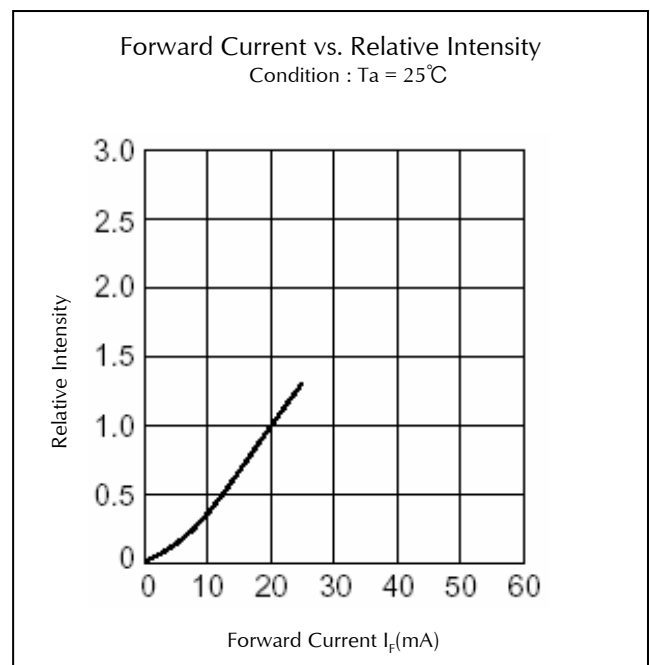
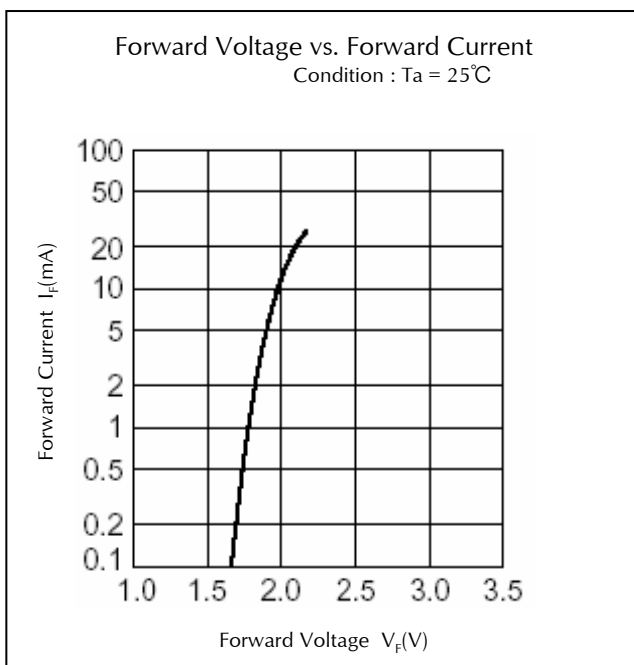
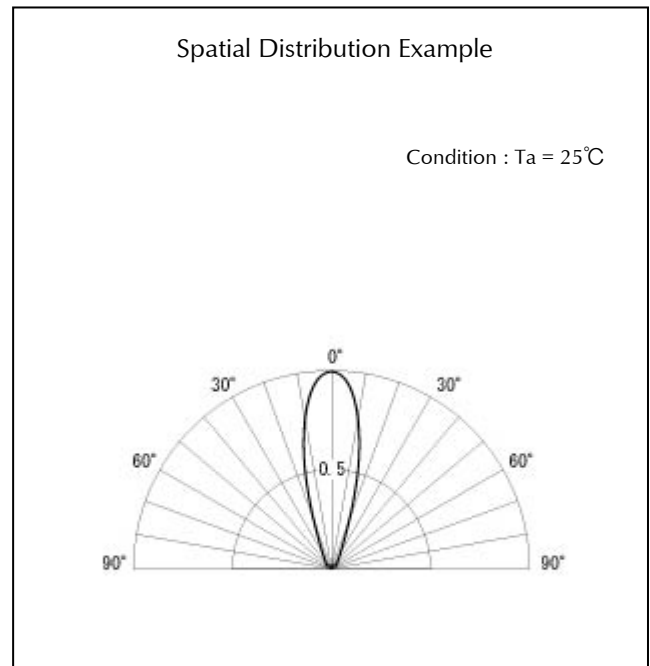
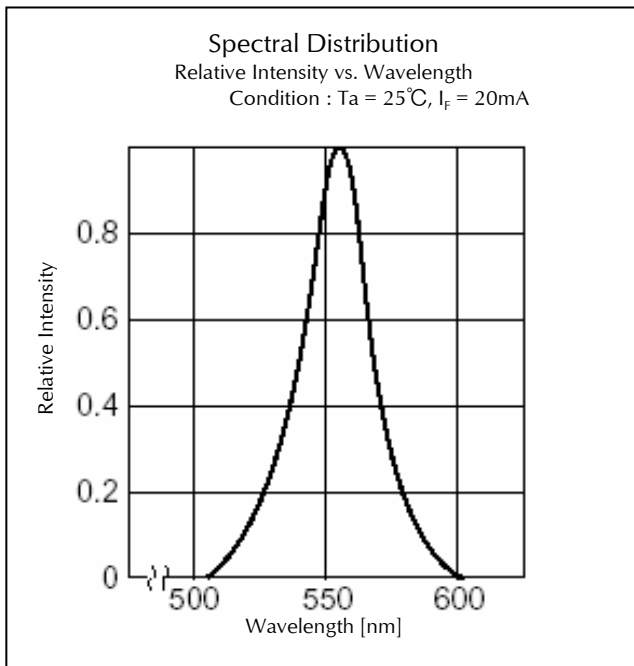

Technical Data(MBG)

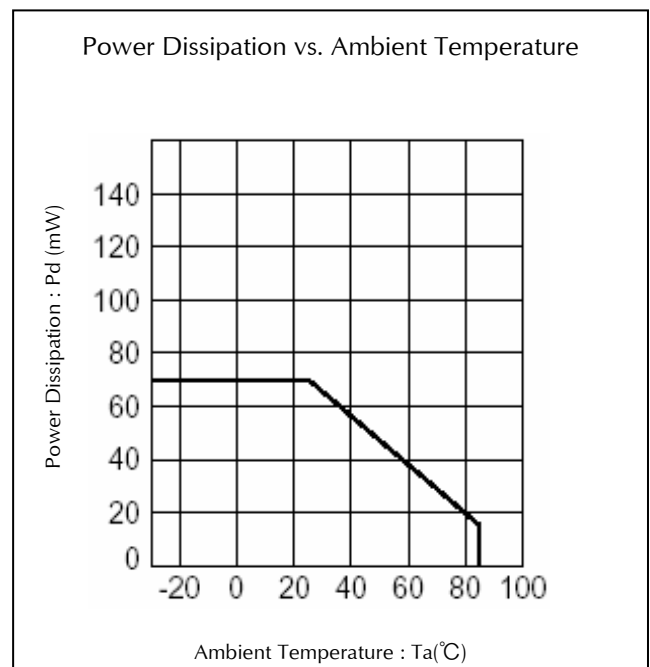
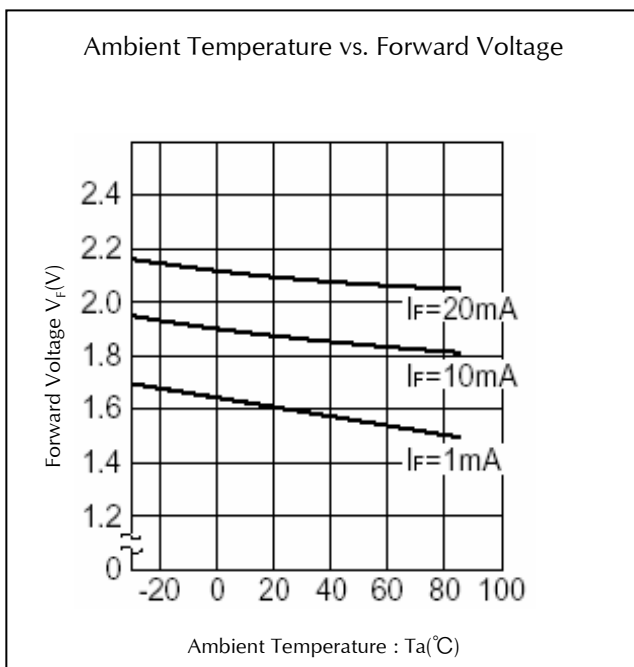
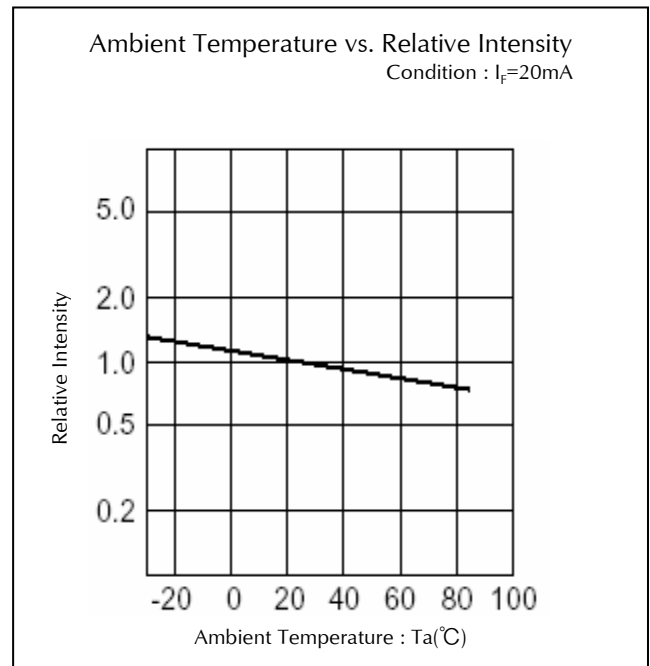
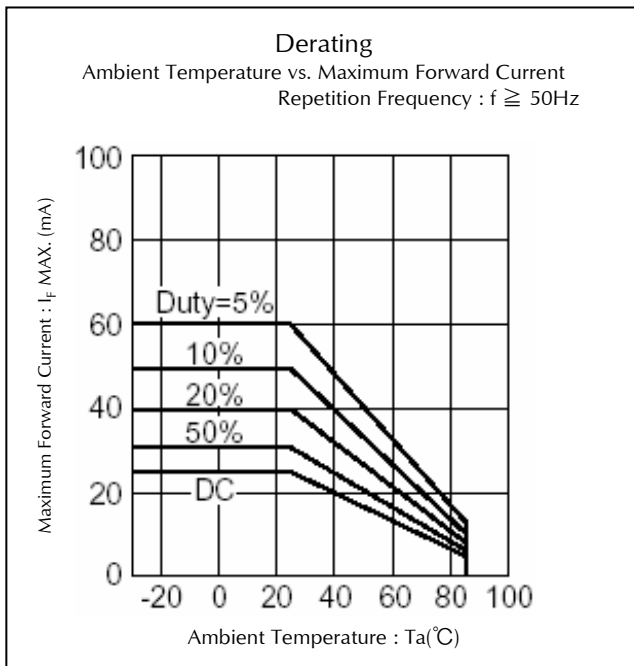

Technical Data(MBG)

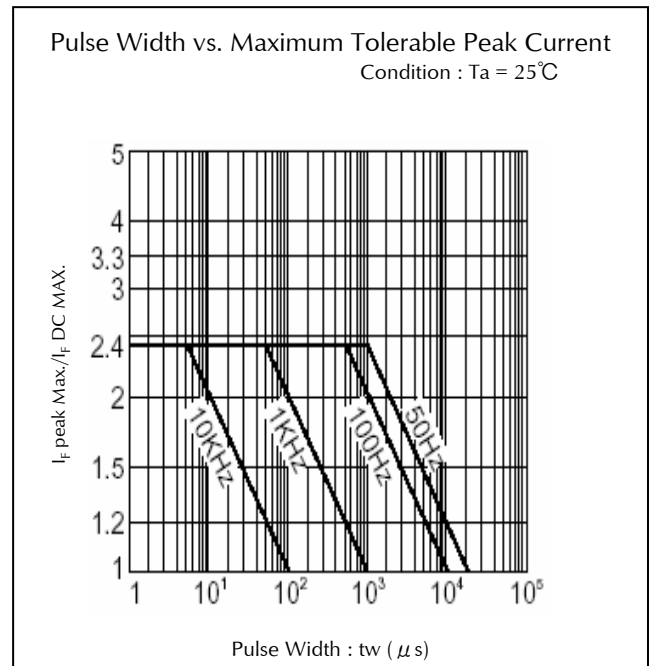
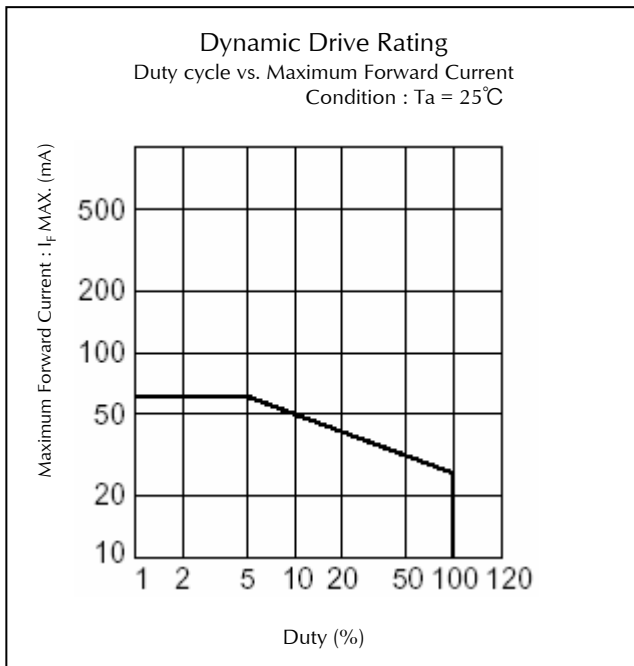

Technical Data(MPG)

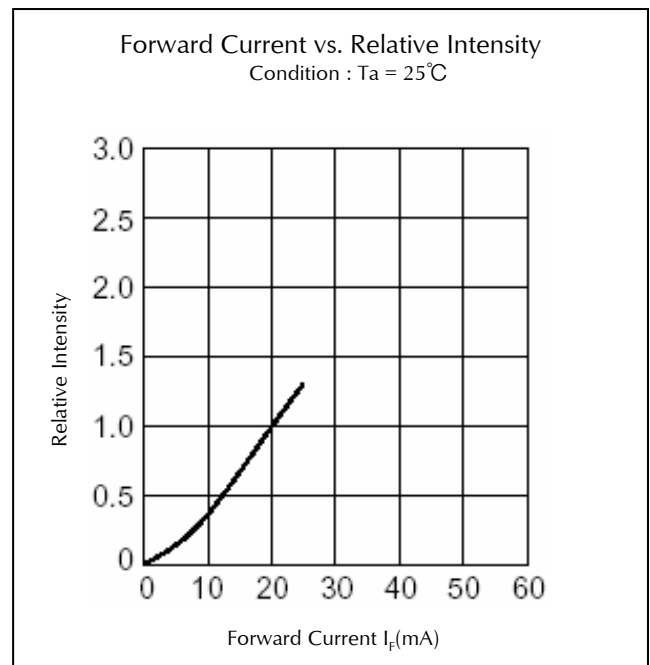
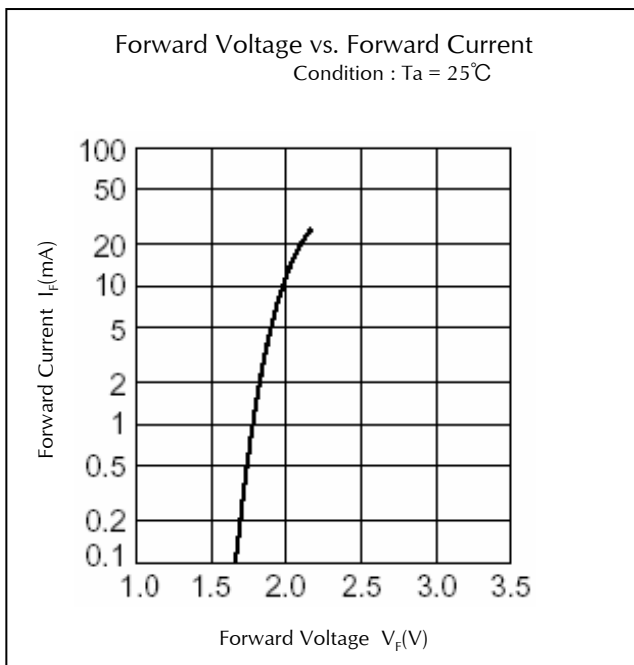
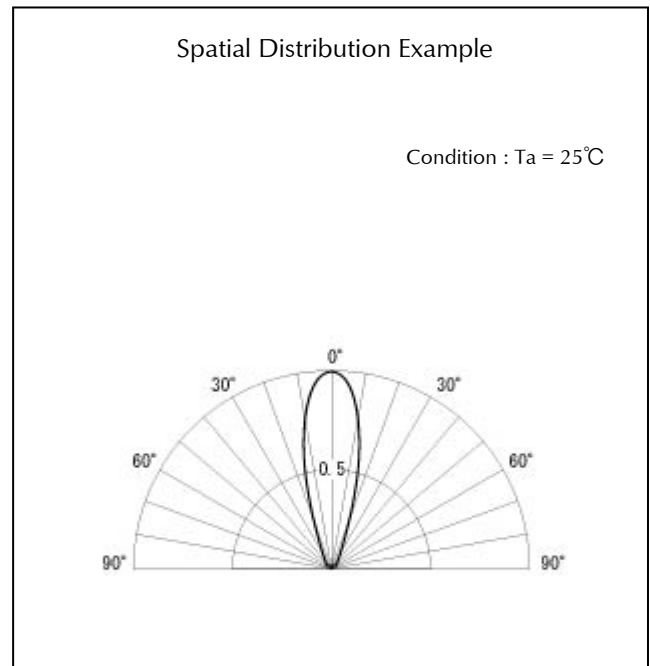
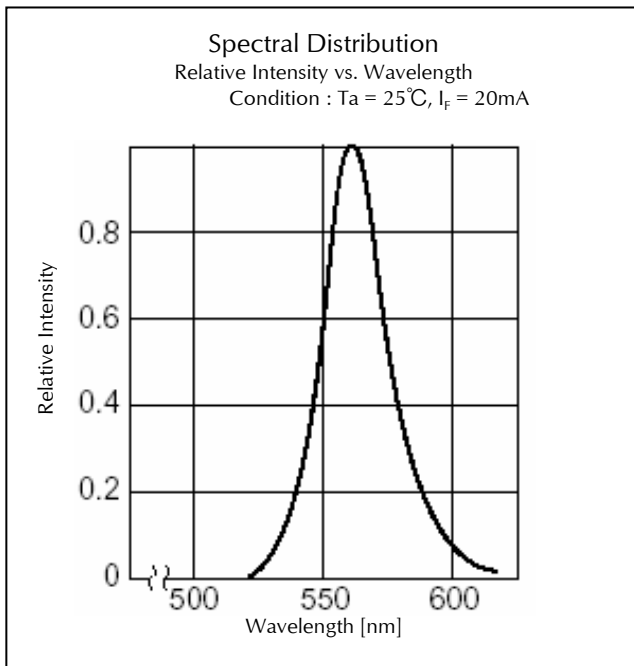

Technical Data(MPG)

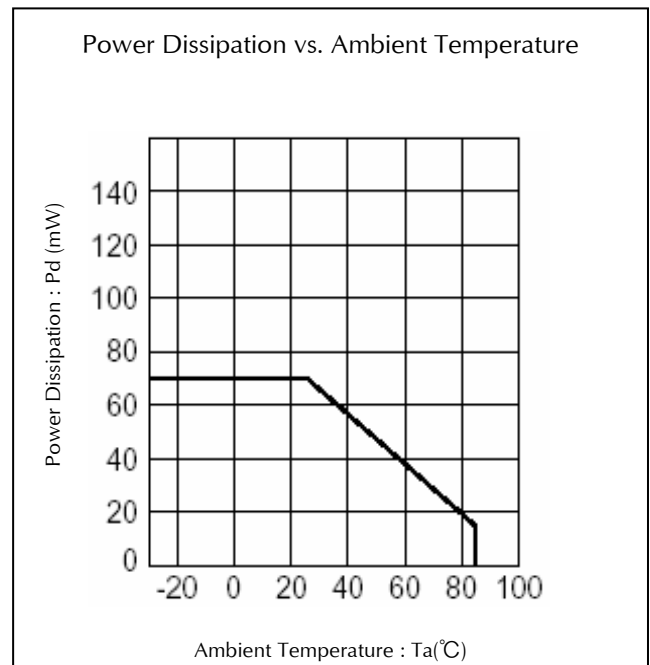
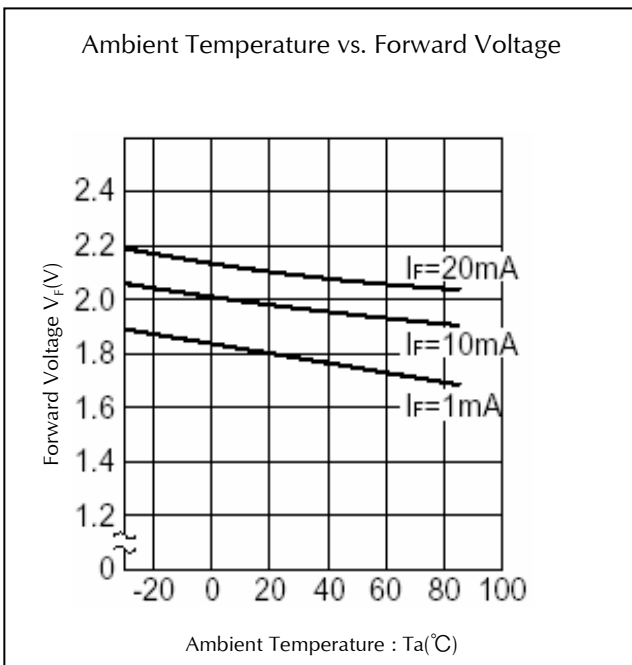
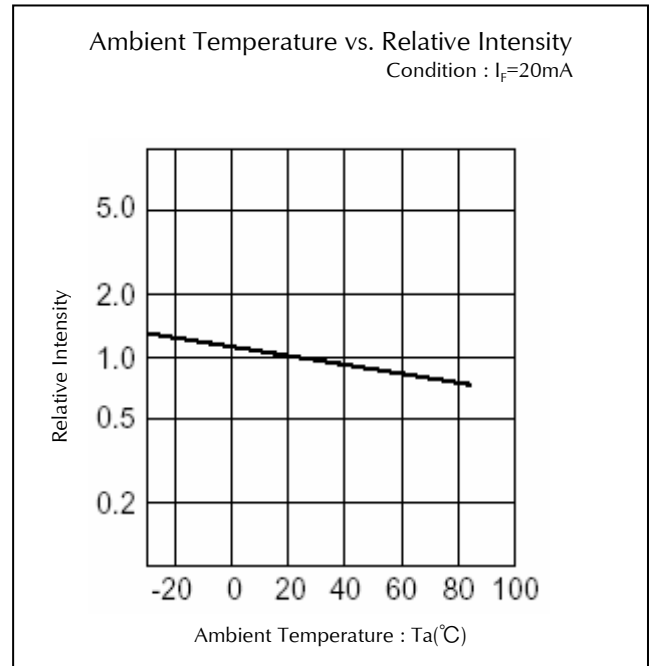
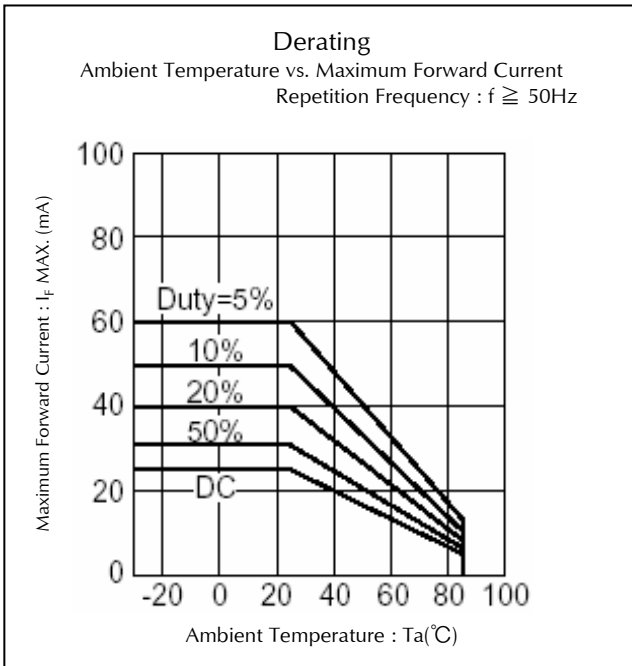

Technical Data(MPG)

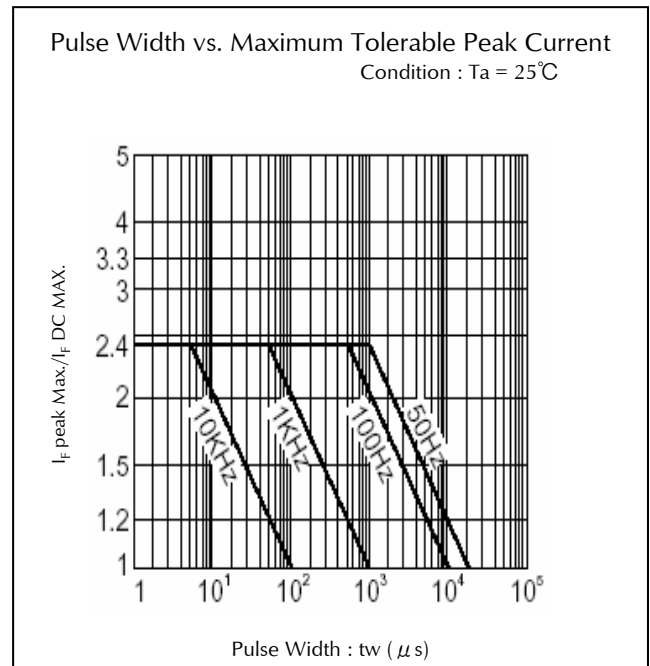
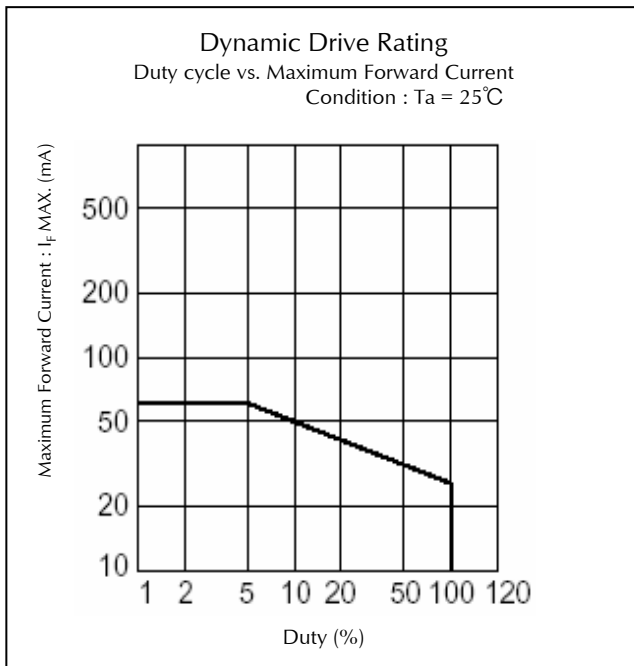

Technical Data(MPY)

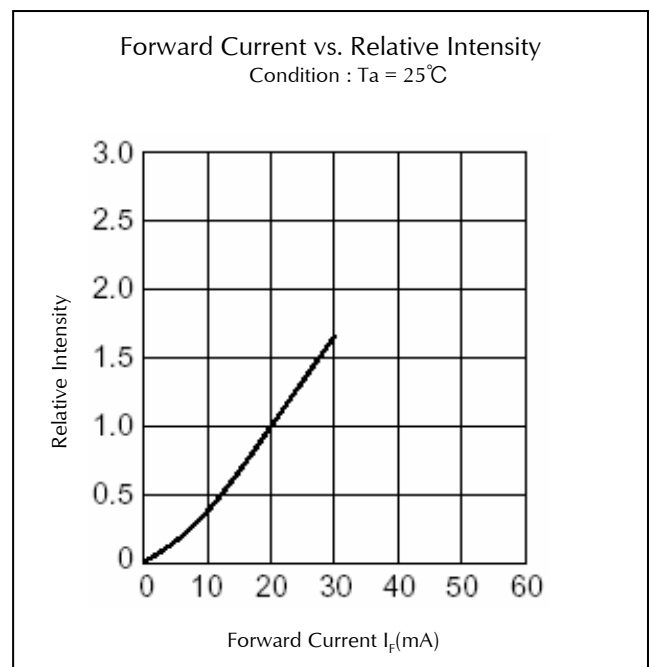
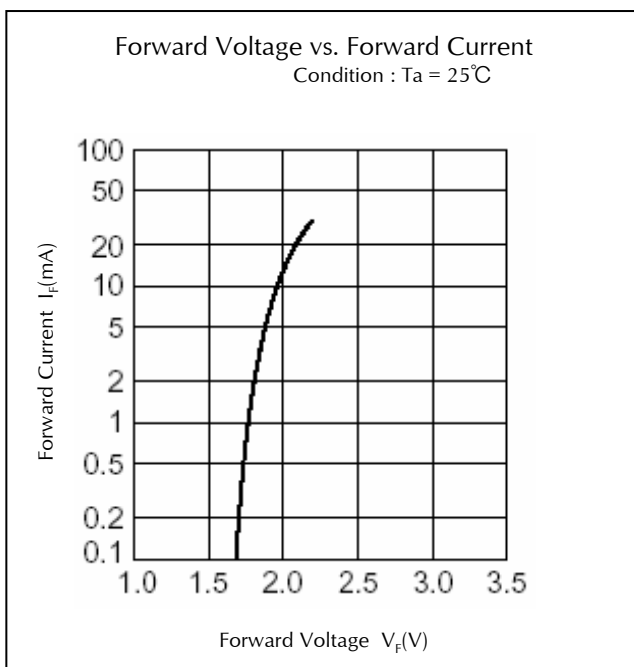
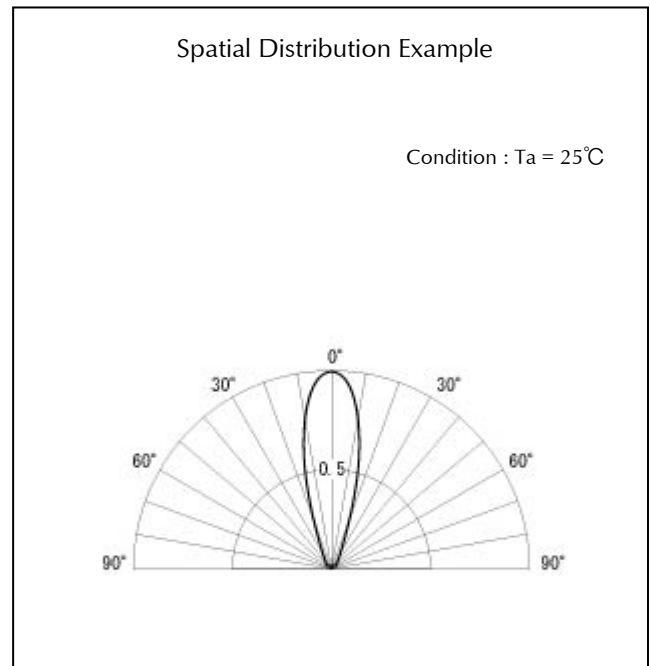
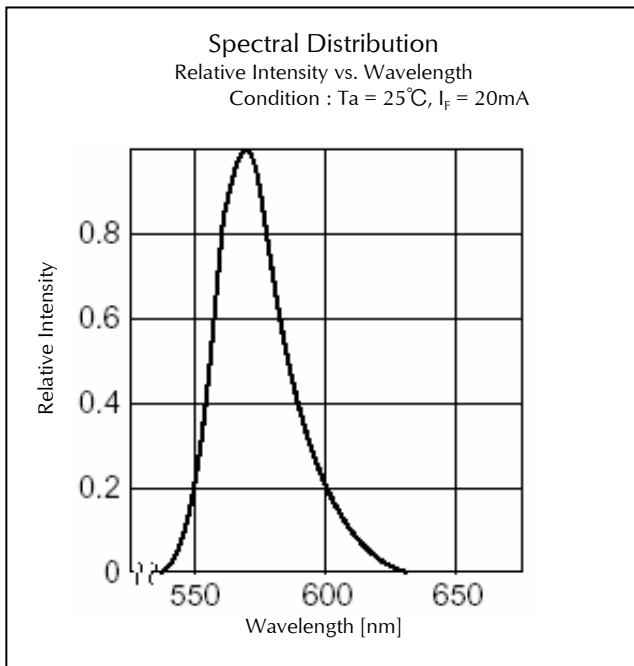

Technical Data(MPY)

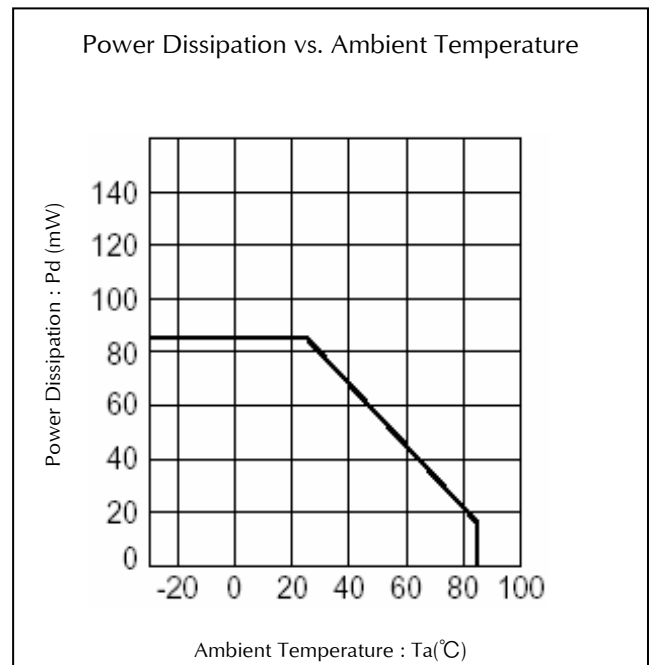
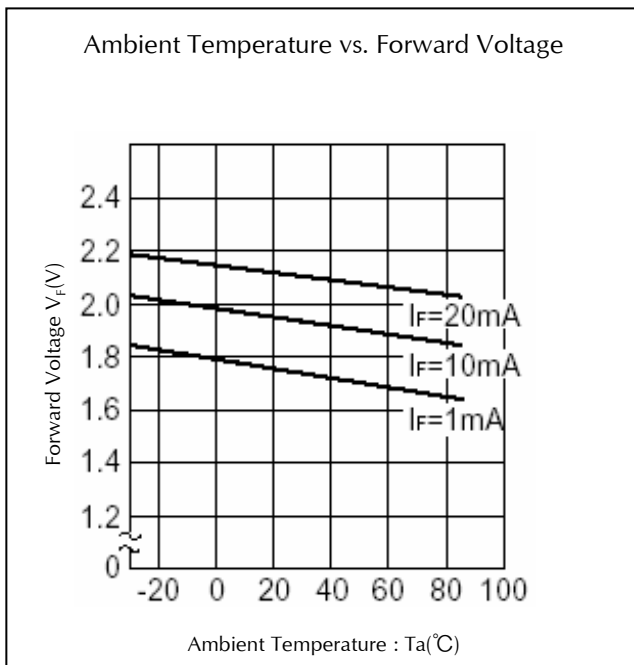
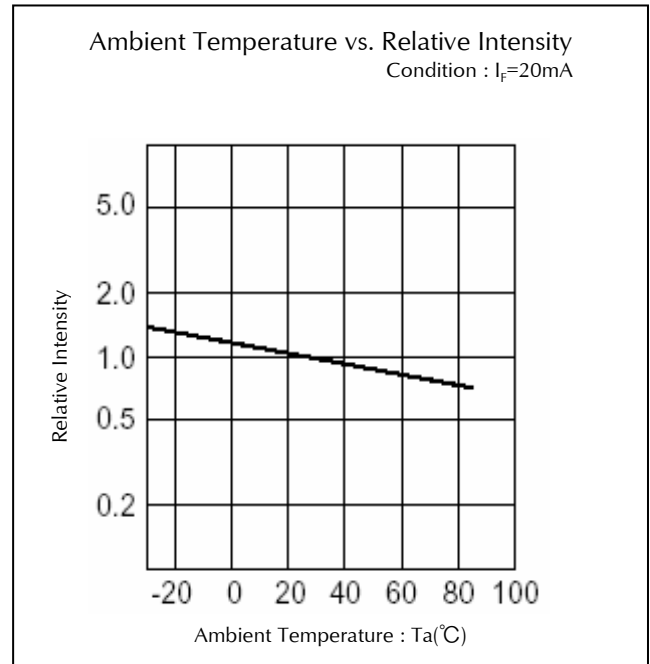
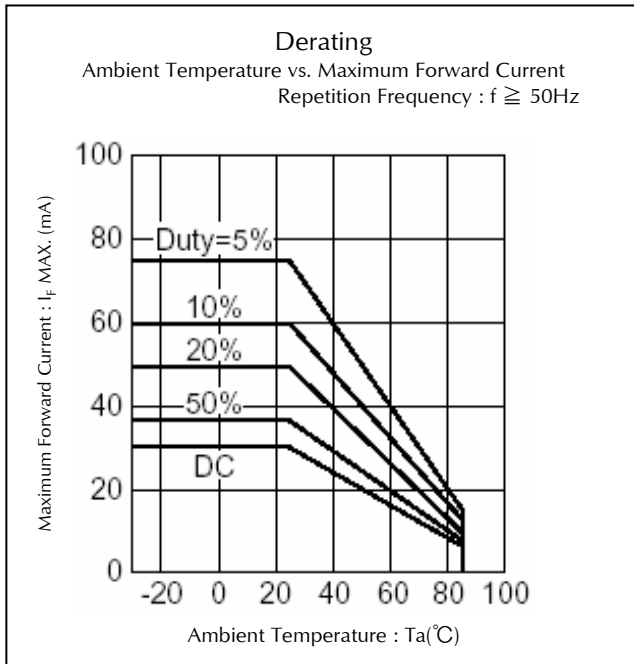

Technical Data(MPY)

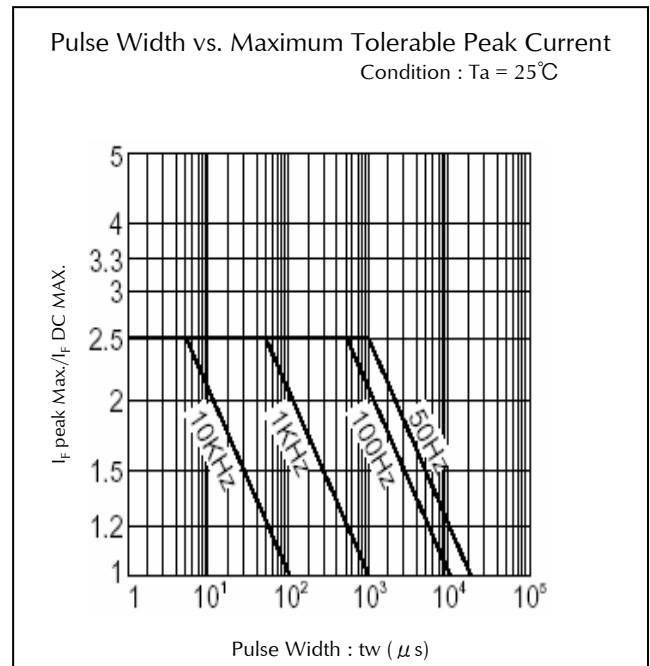
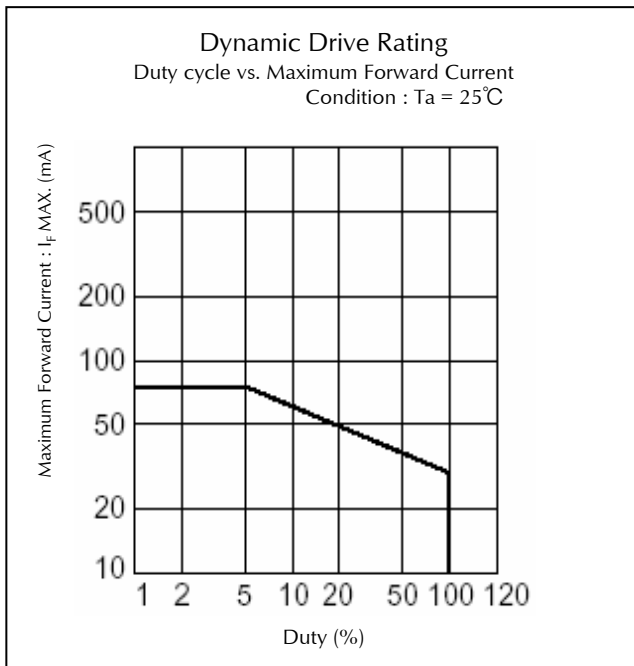

Technical Data(MAY)

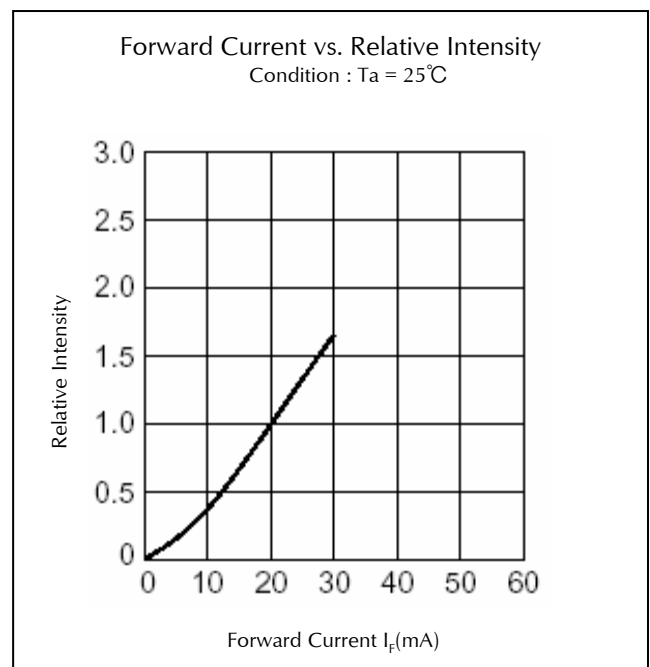
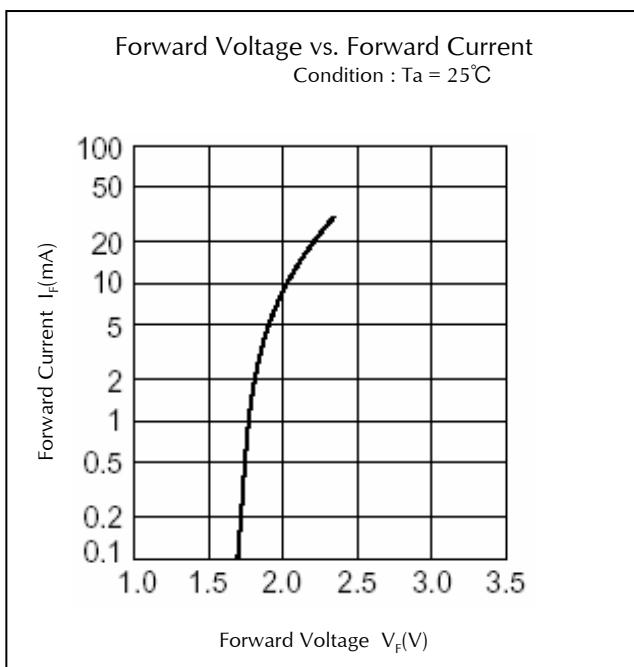
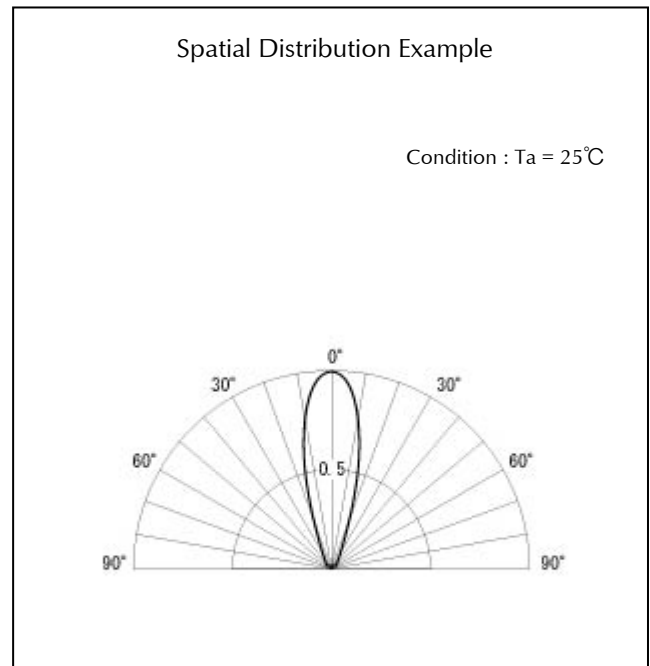
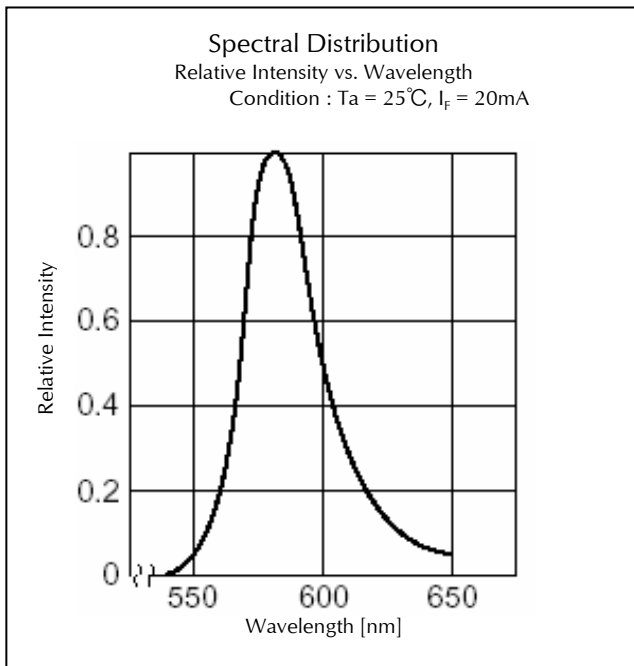

Technical Data(MAY)

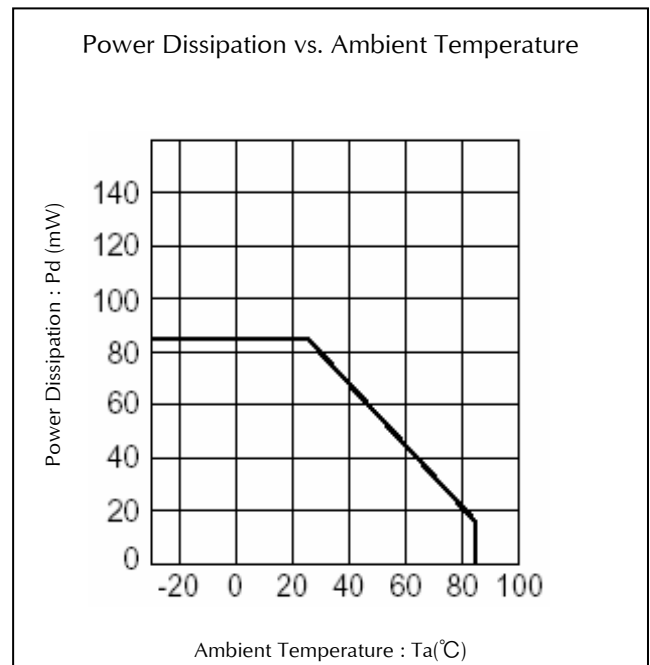
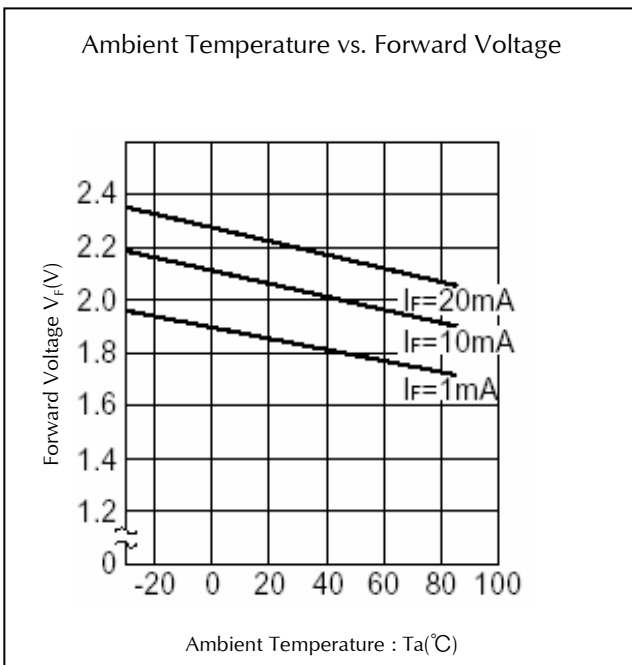
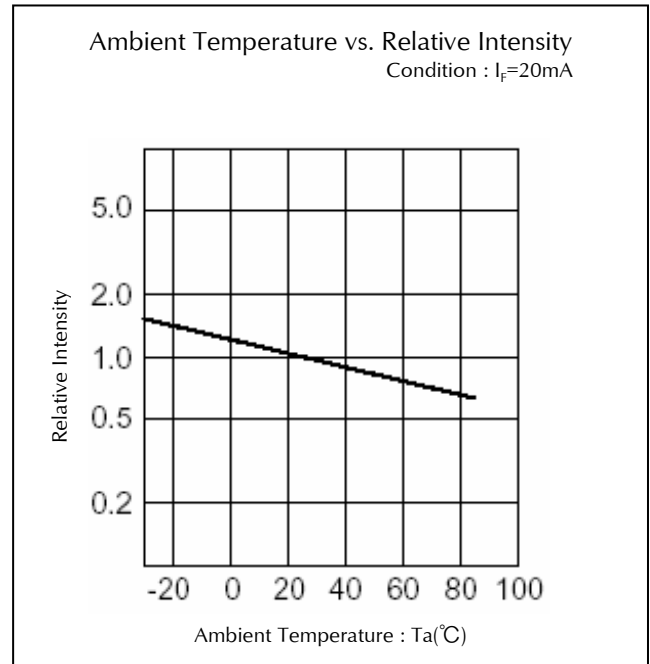
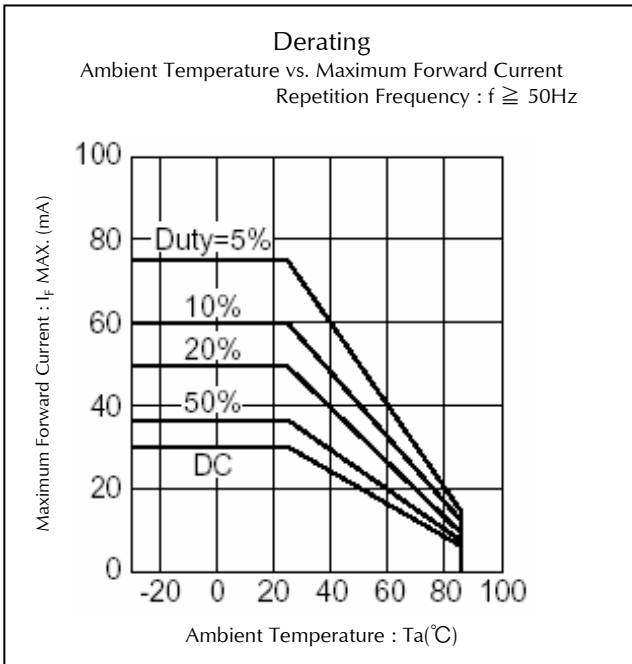

Technical Data(MAY)

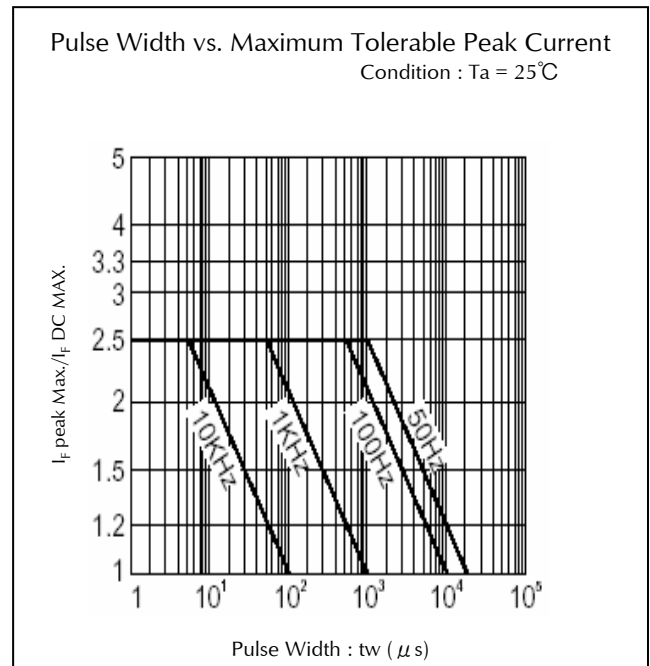
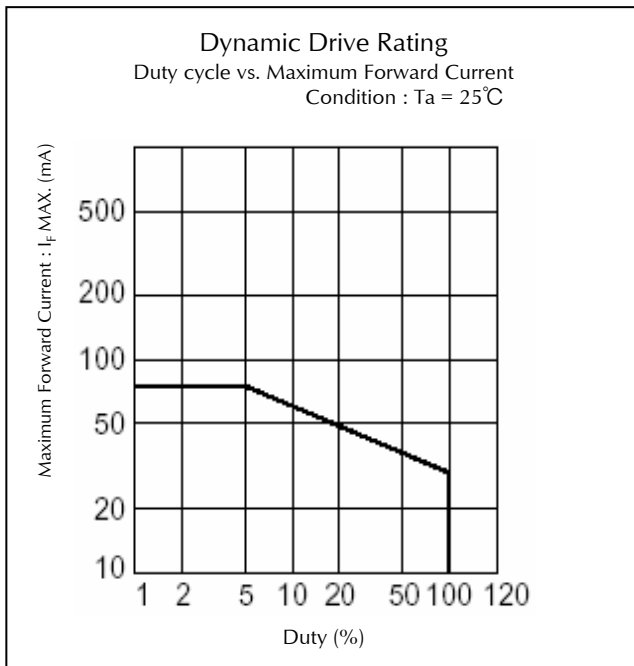

Technical Data(MAA)

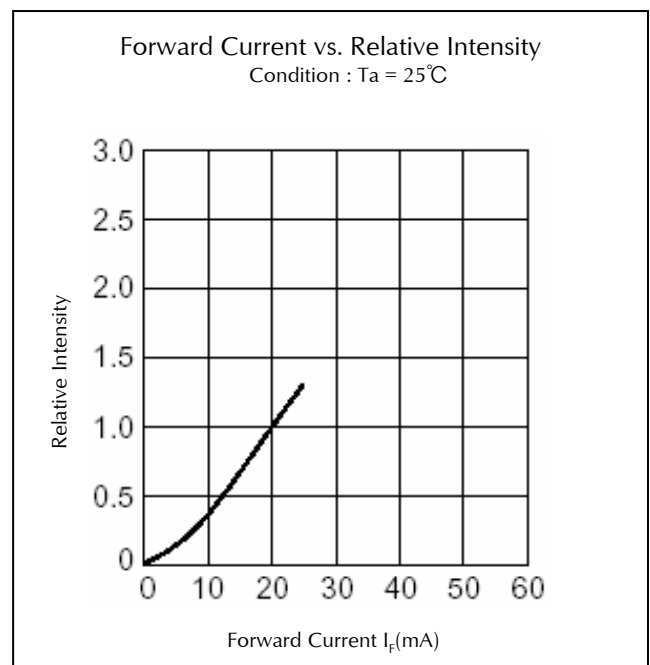
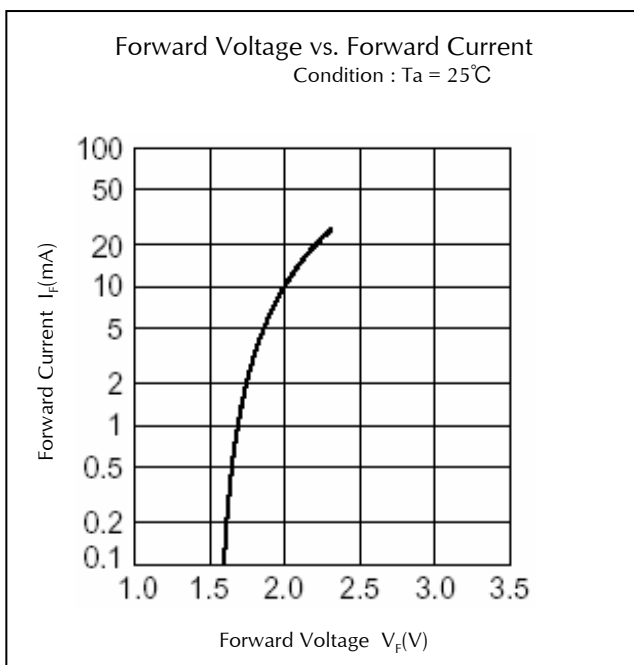
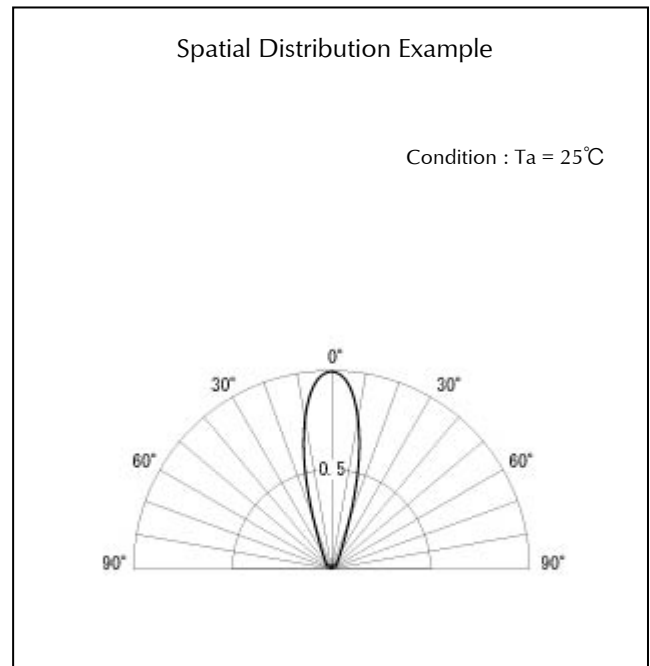
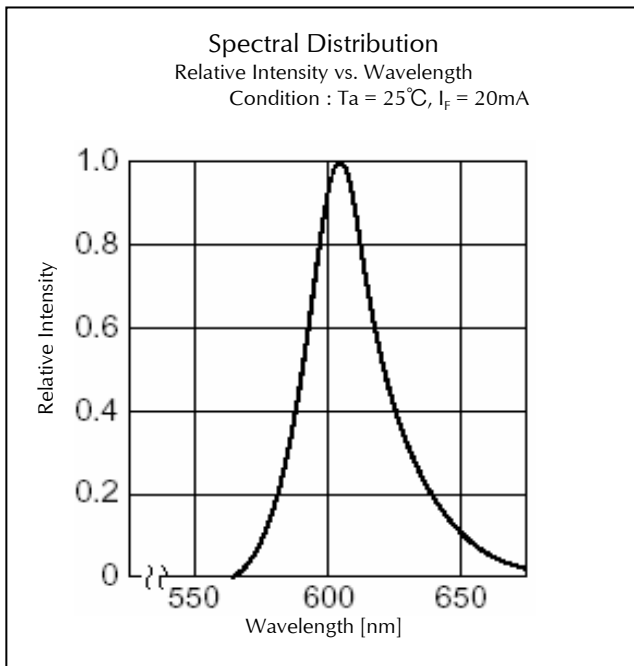

Technical Data(MAA)

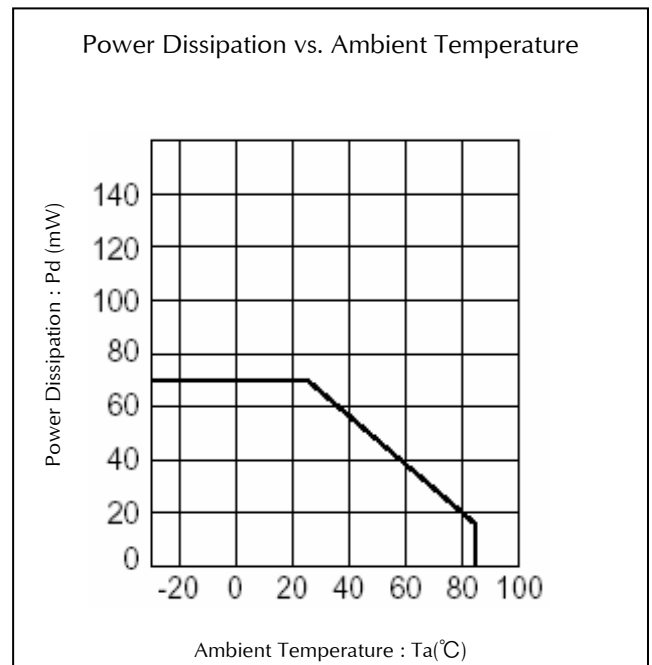
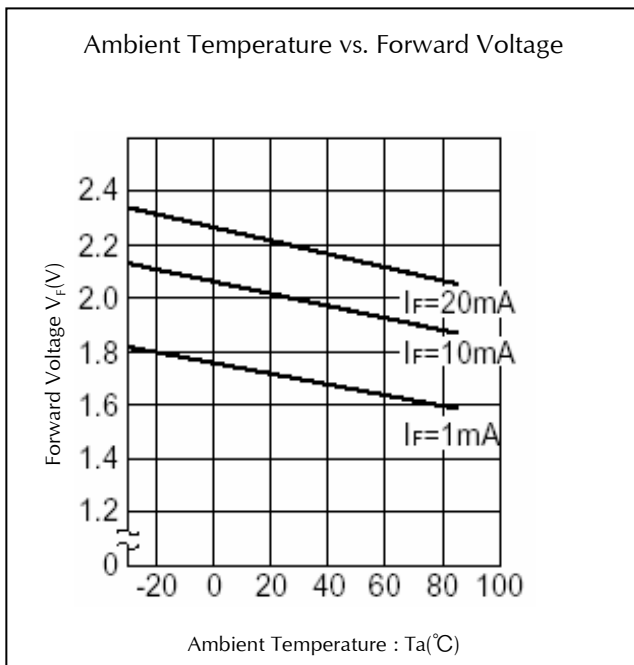
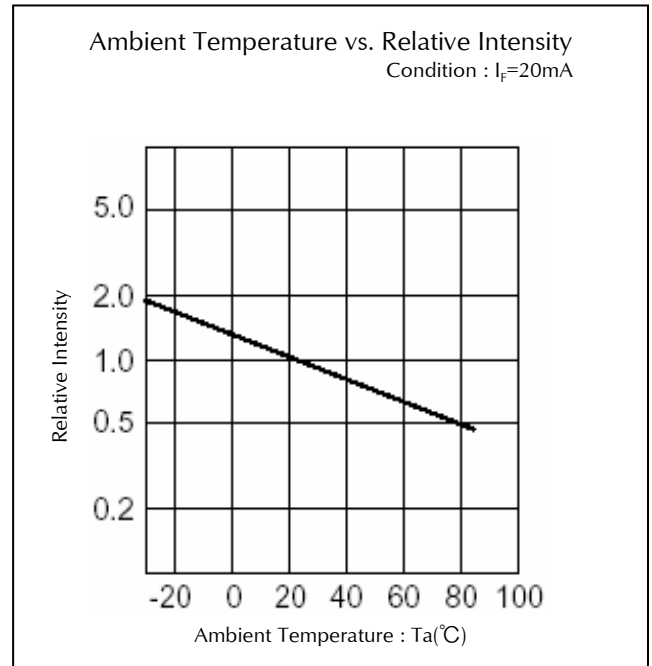
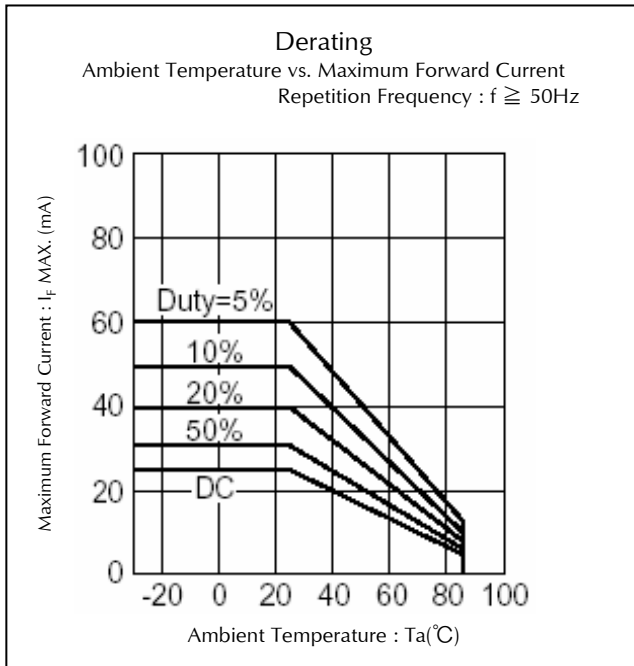

Technical Data(MAA)

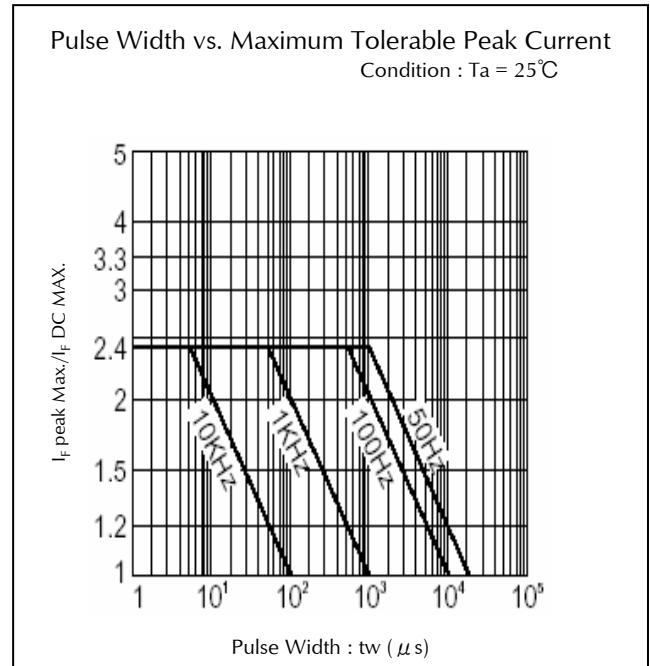
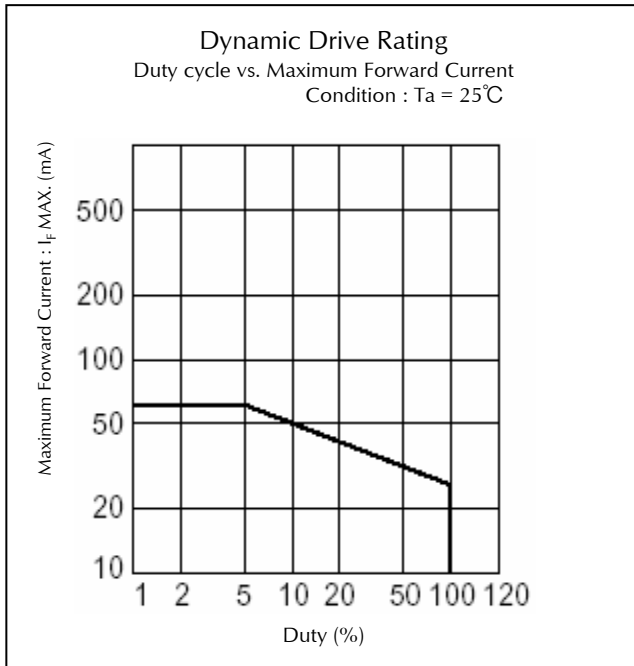

Technical Data(MVR)

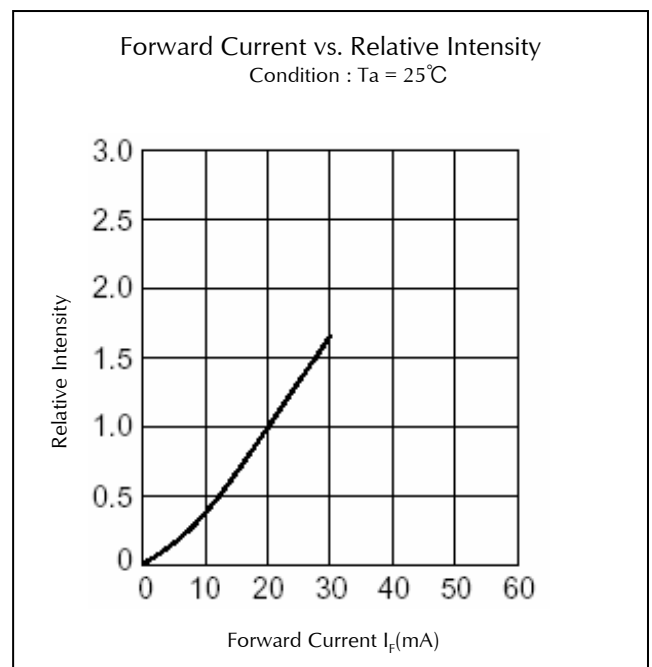
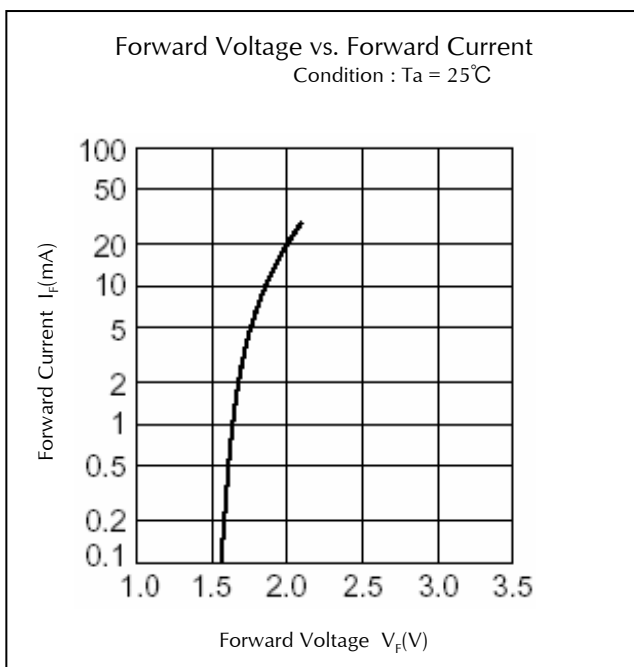
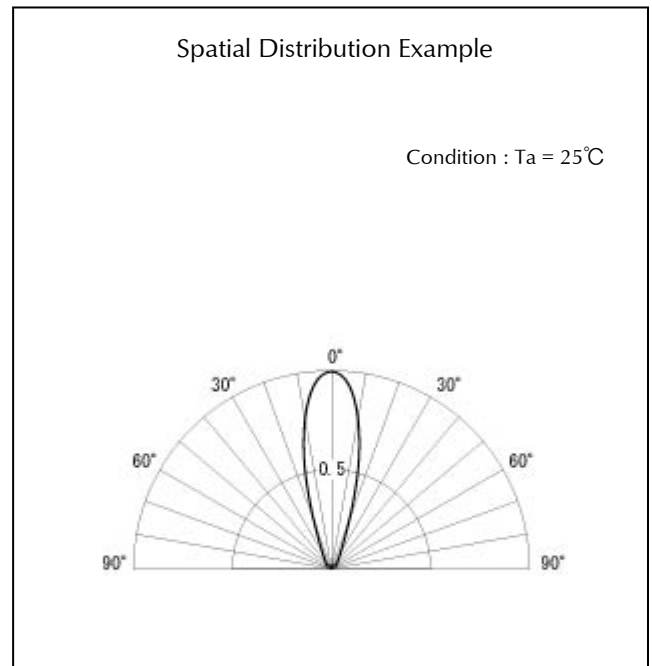
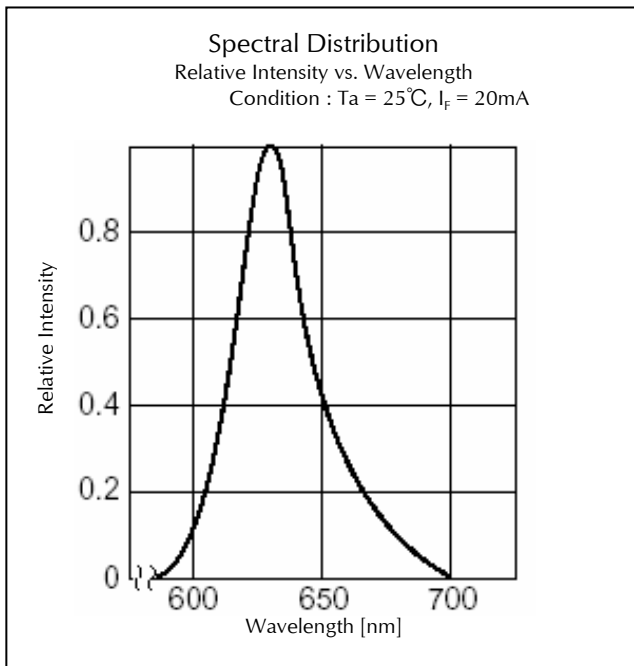

Technical Data(MVR)

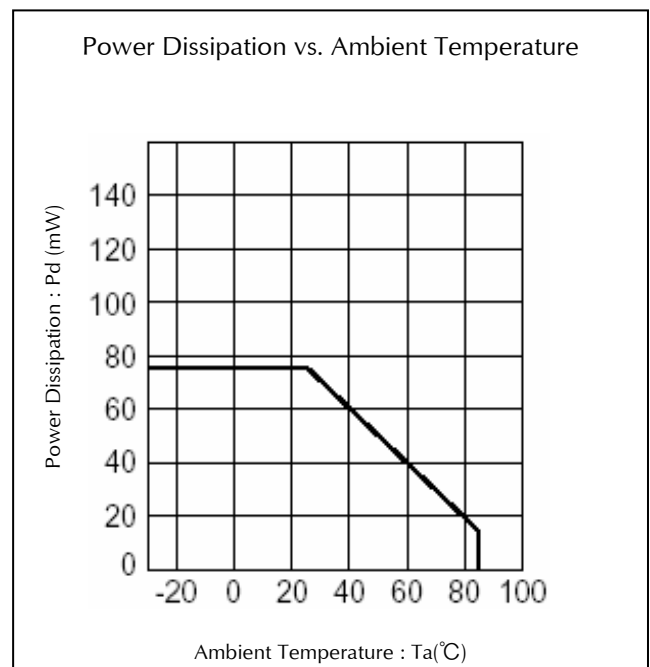
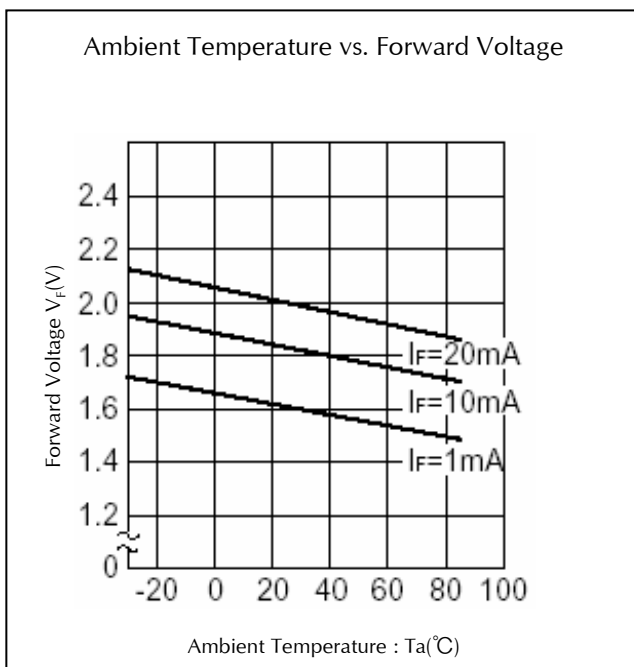
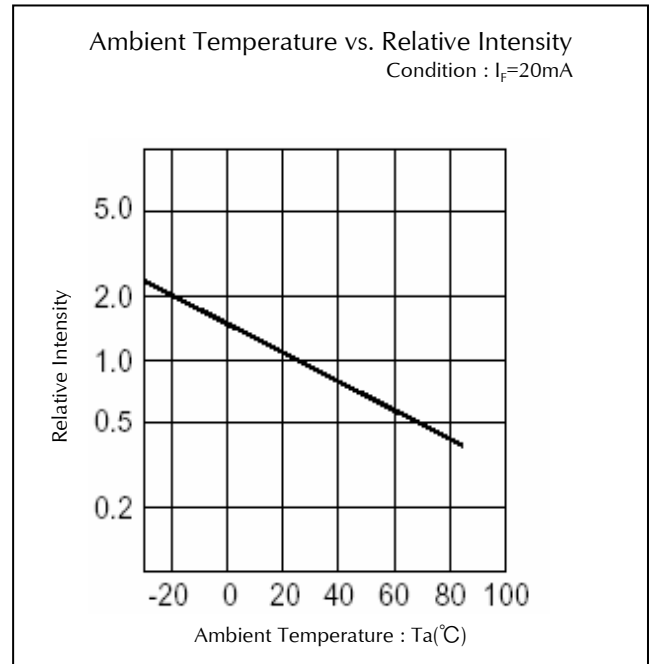
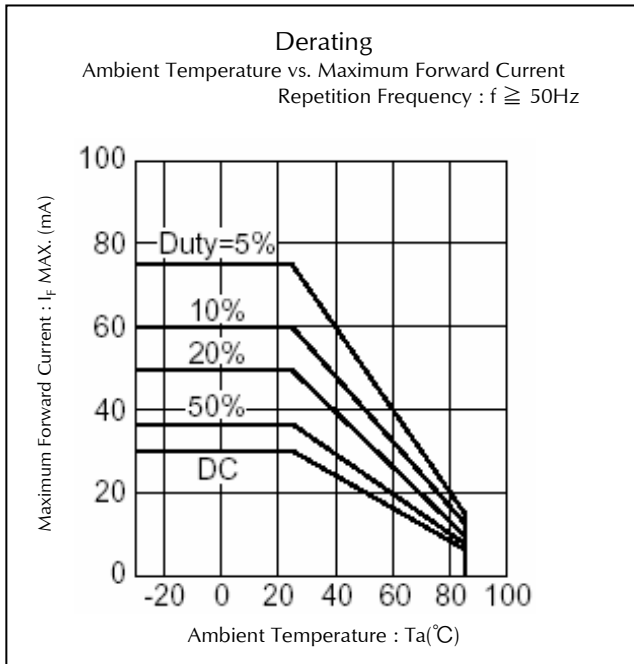

Technical Data(MVR)

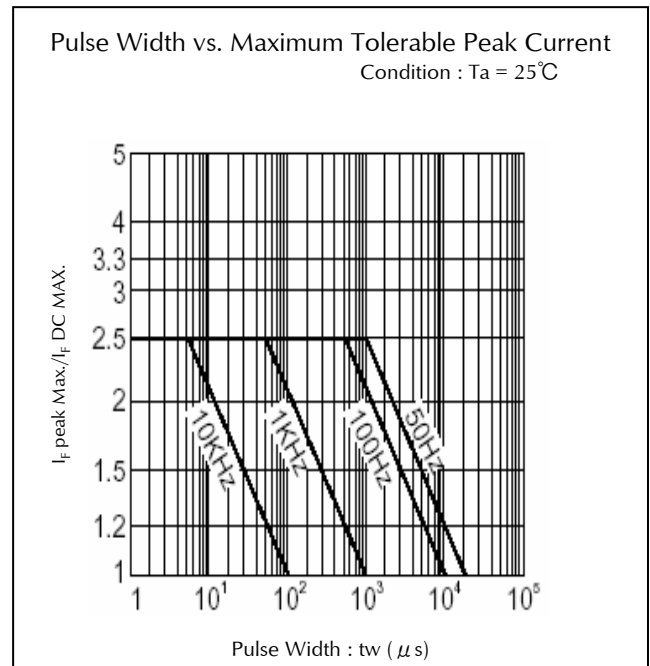
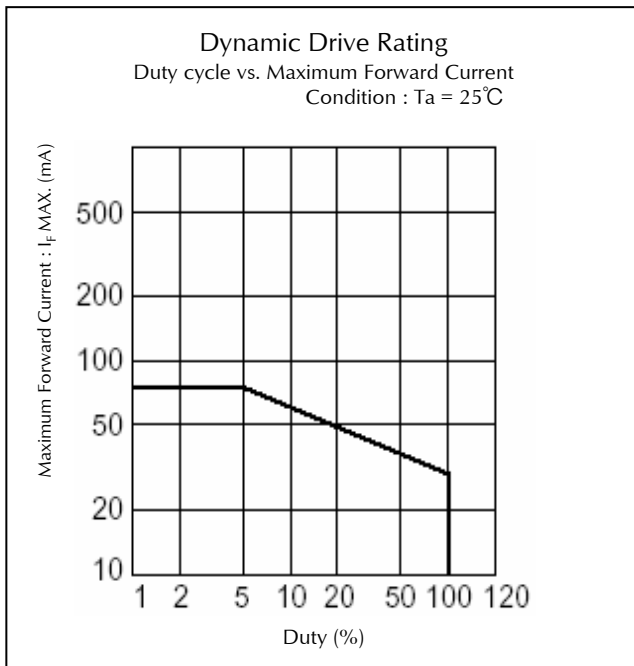

Technical Data(BR)

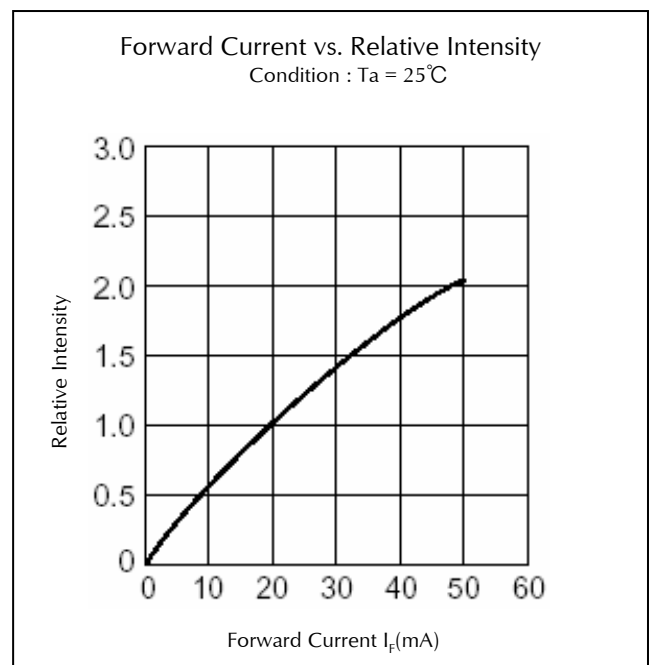
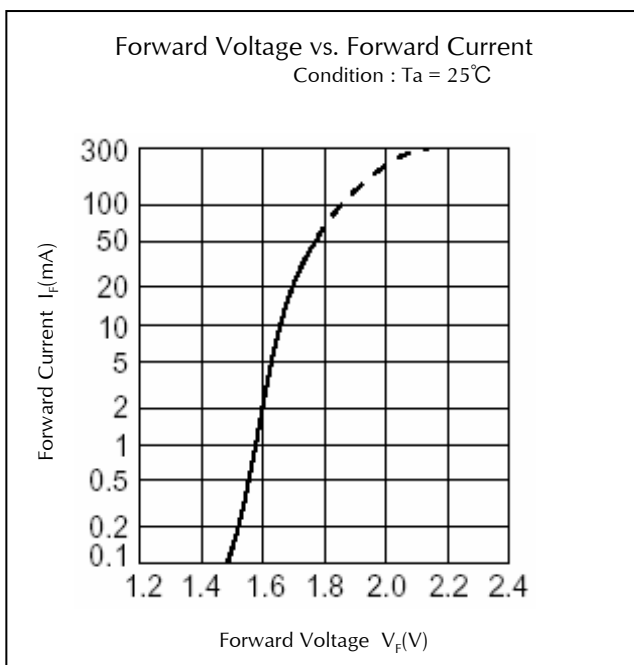
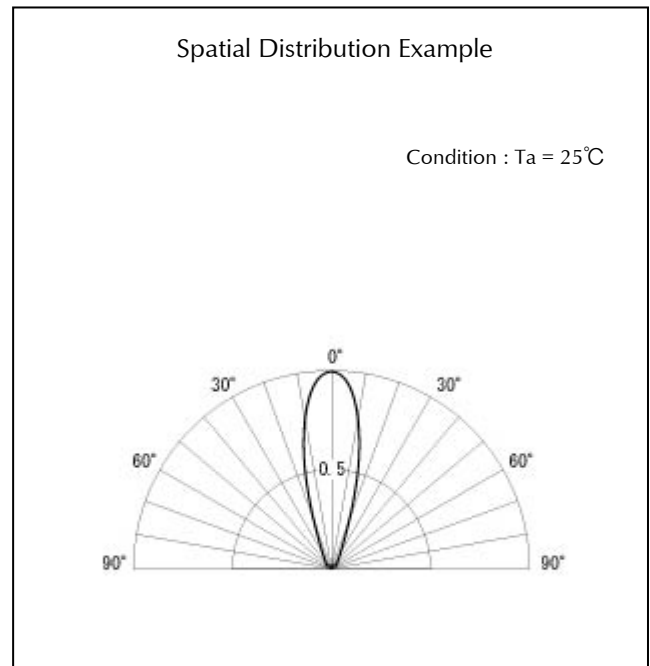
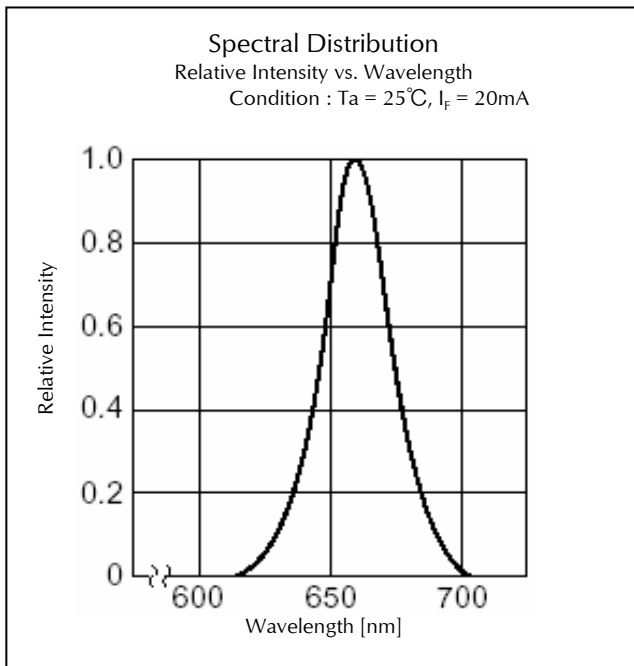

Technical Data(BR)

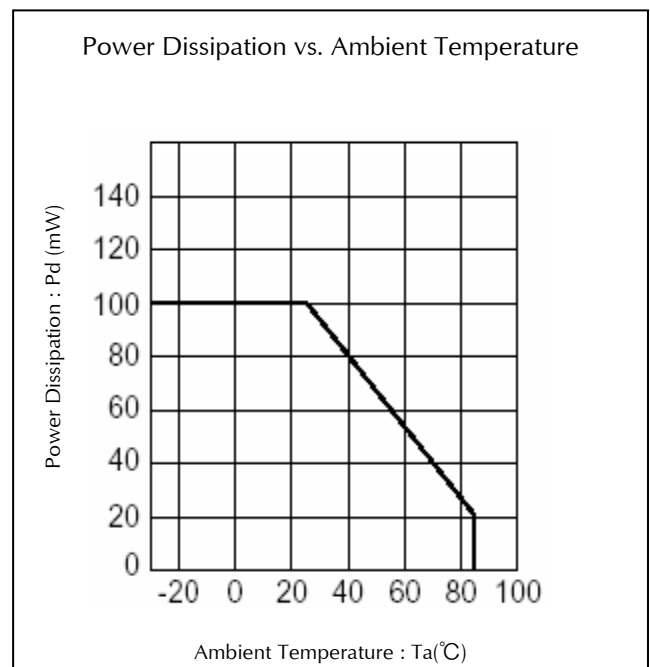
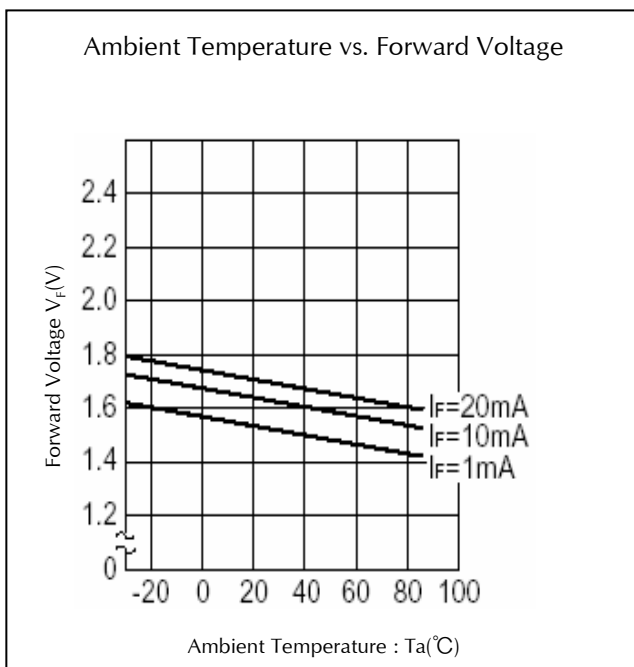
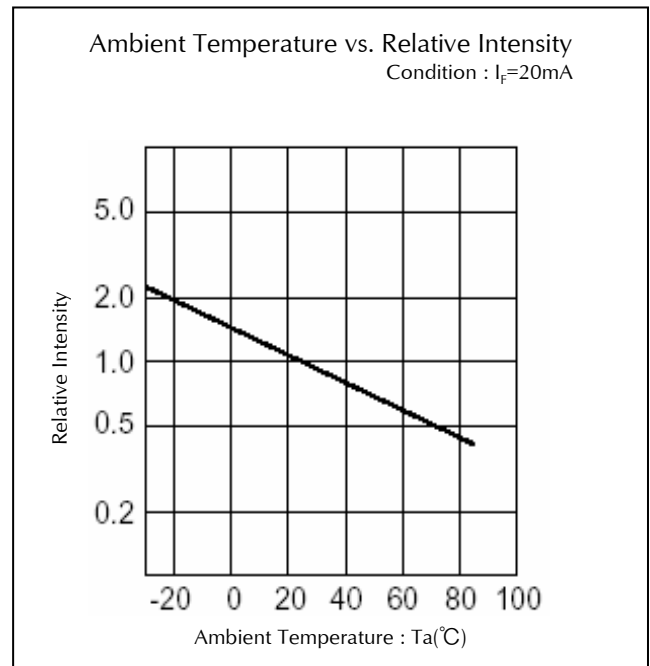
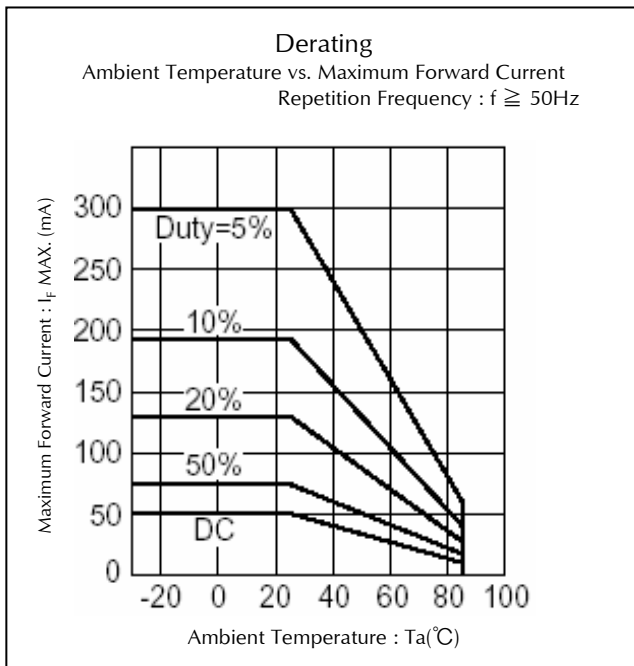

Technical Data(BR)

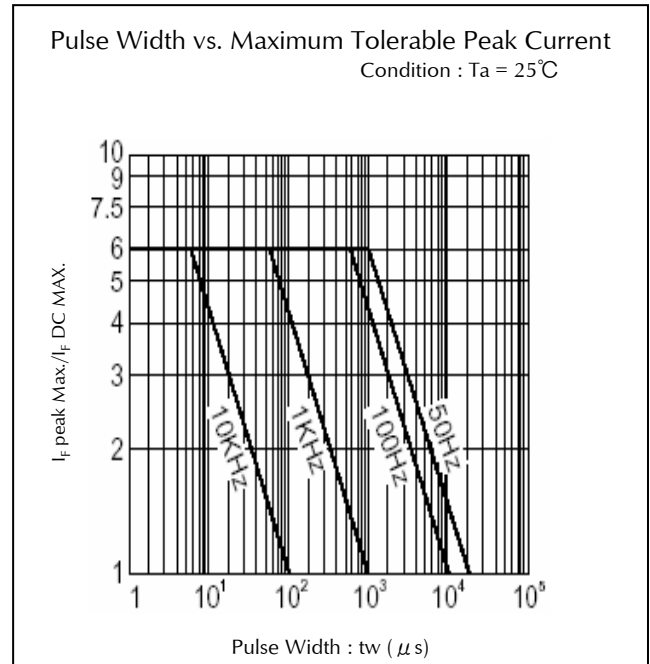
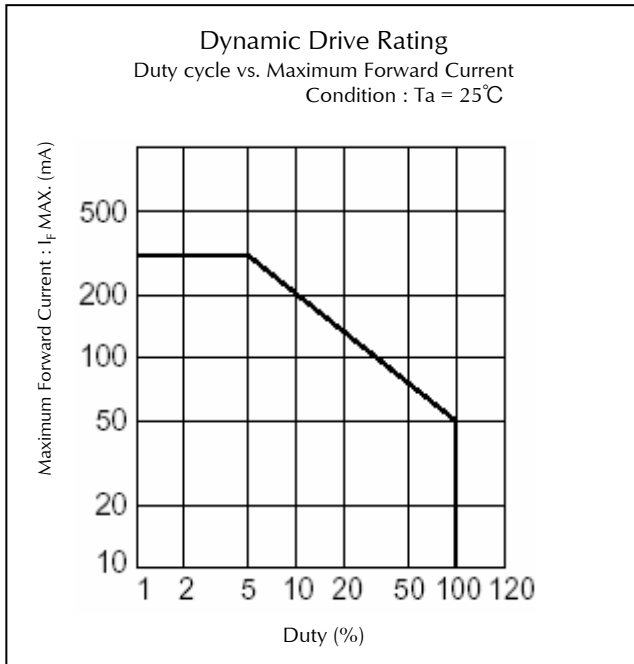

Technical Data(MPR)

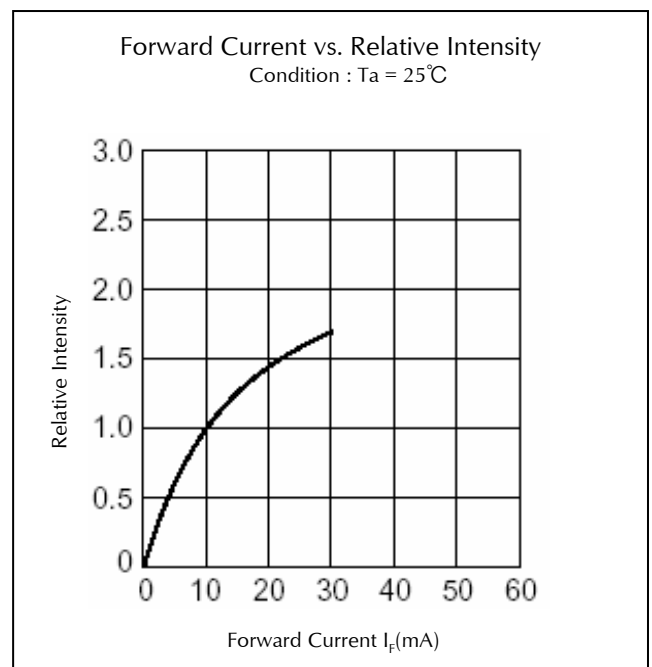
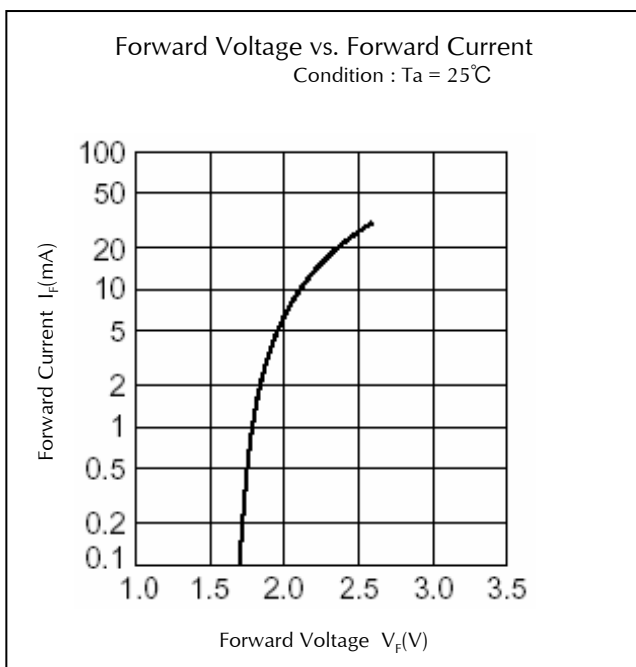
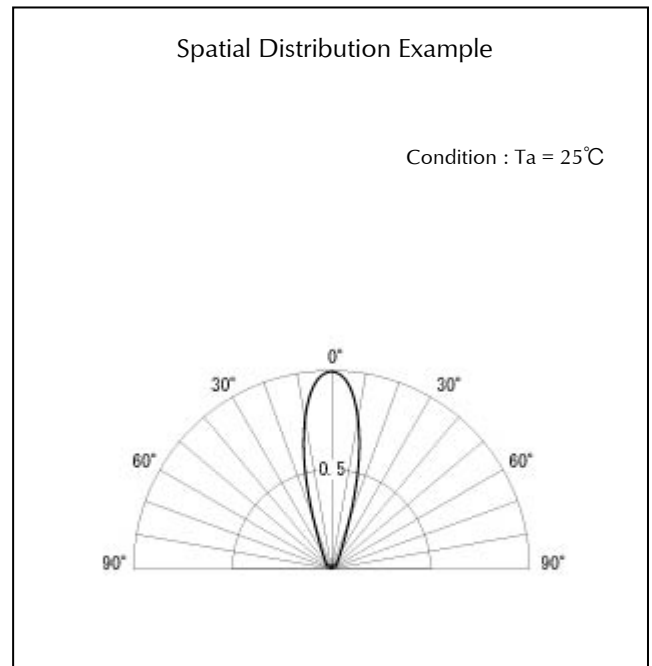
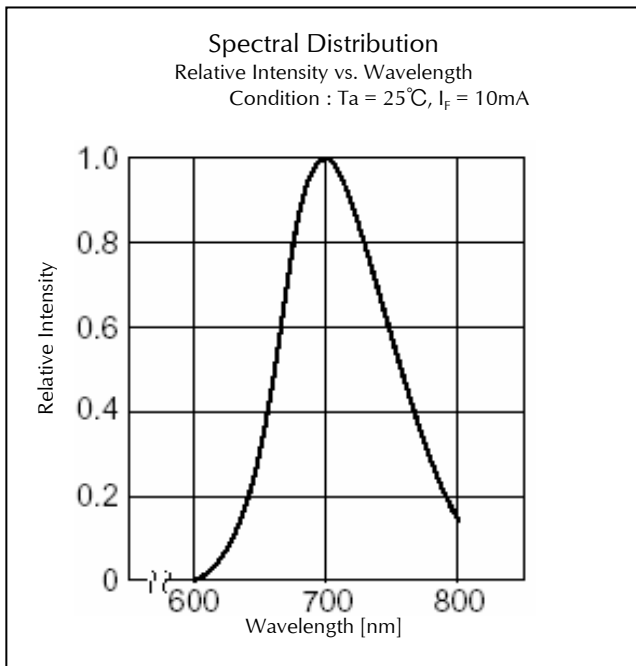

Technical Data(MPR)

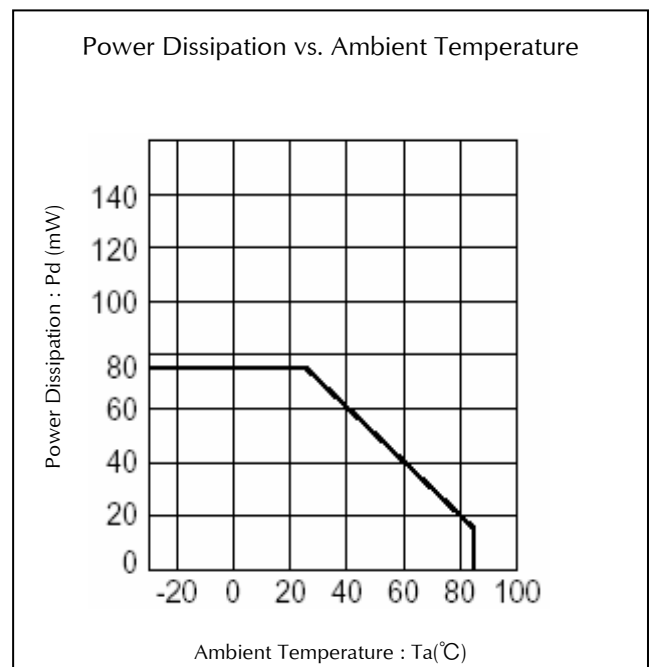
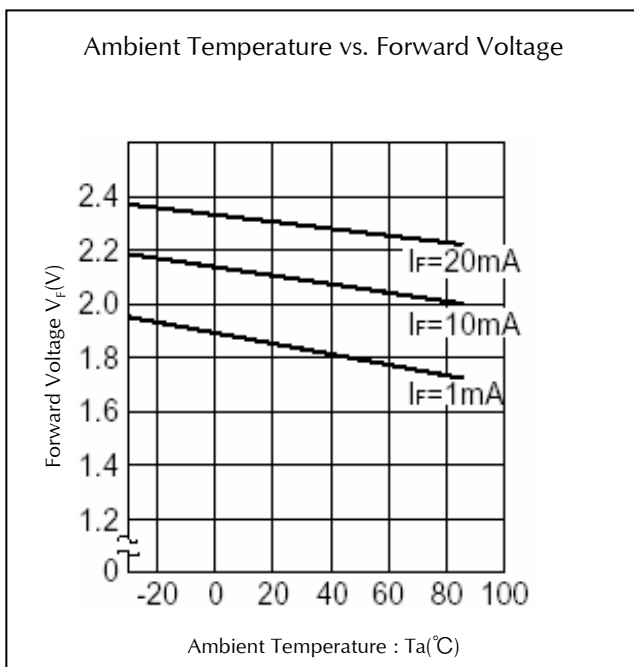
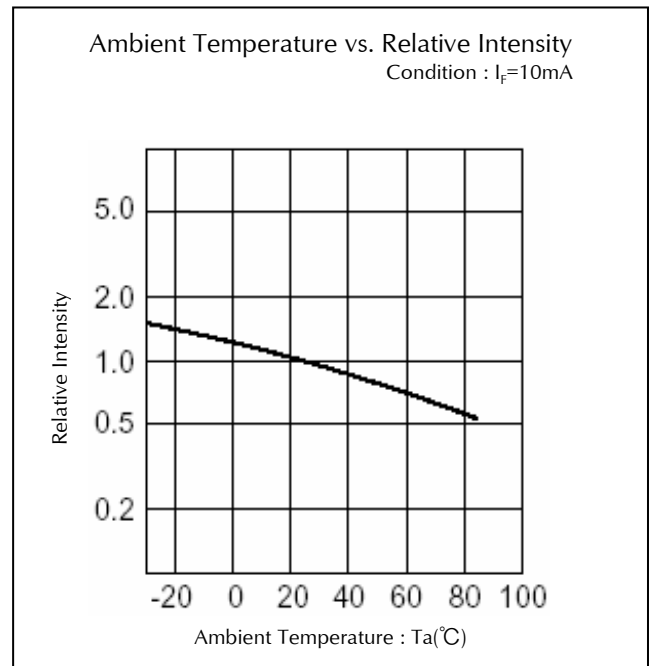
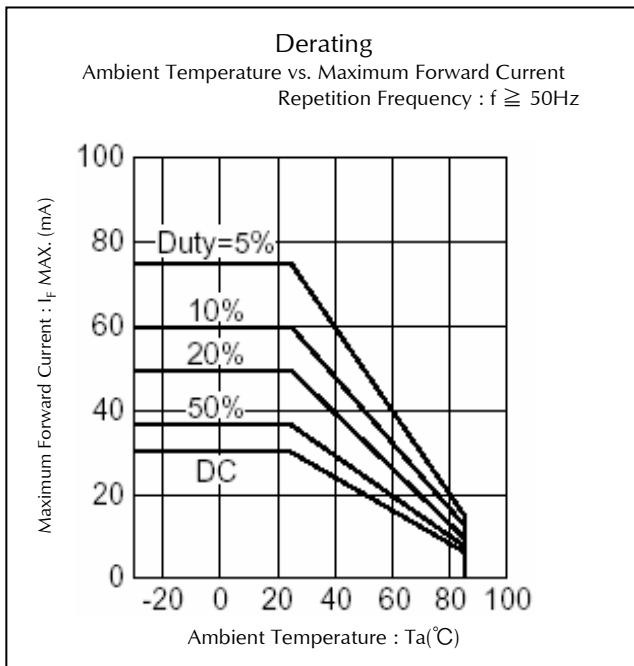

Technical Data(MPR)

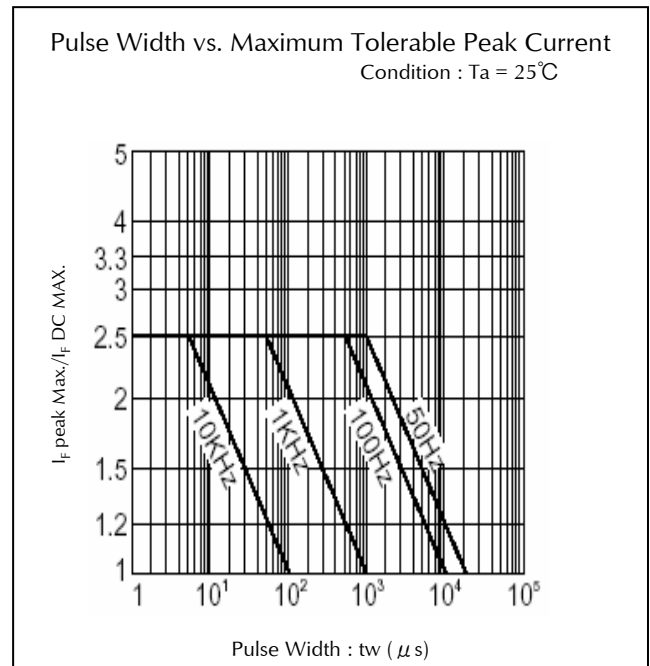
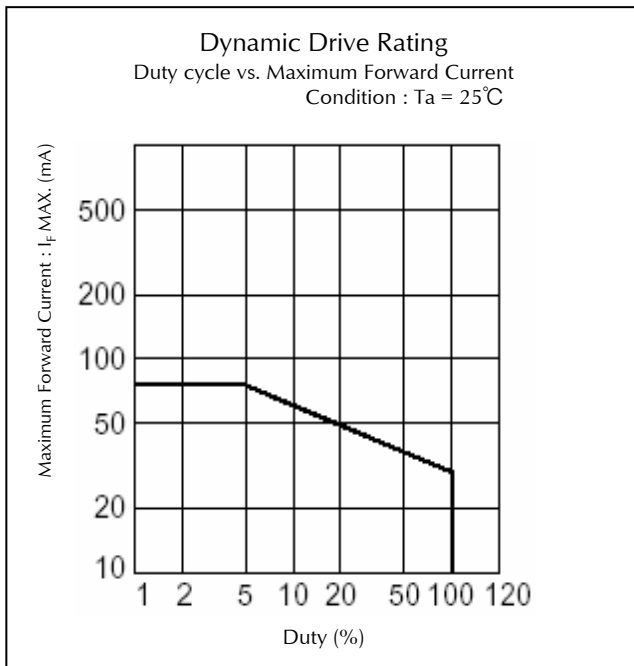

Package Dimensions

(Unit: mm)

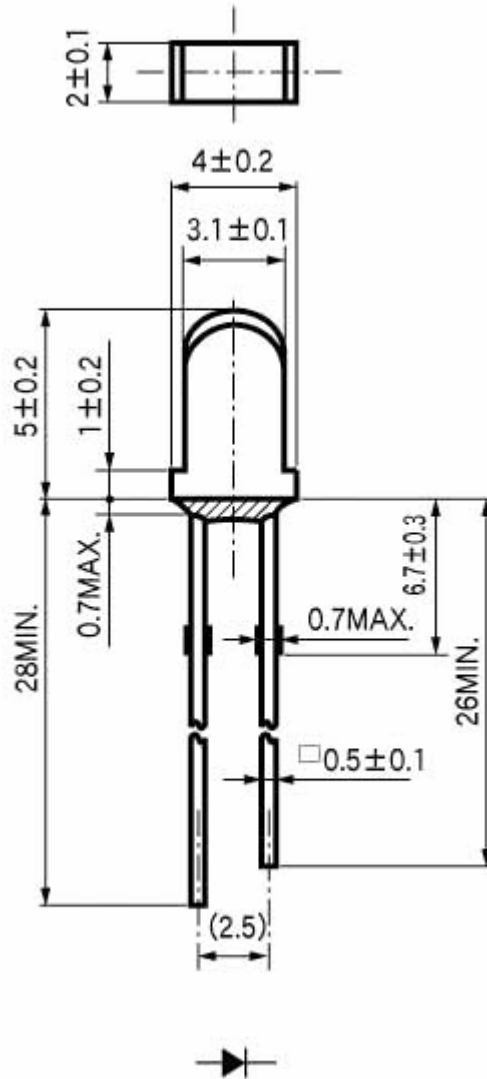

TTW (Through The Wave) soldering Conditions

Pre-heating	100 °C	(MAX.)
Solder Bath Temp.	265°C	(MAX.)
Dipping Time	5 s	(MAX.)

- 1) The dip soldering process shall be 2 times maximum.
- 2) The product shall be cooled to room temp. before the second dipping process.
 - ※The detail is described to LED and Photodetector handling precautions of home page: "Mounting through-hole Type Devices" and "Soldering", and use it after the confirmation, please.

Manual Soldering Conditions

Iron tip temp.	400°C	(MAX.)
Soldering time and frequency	3 s	(MAX.)
	2 times	(MAX.)

- ※The detail is described to LED and Photodetector handling precautions of home page: "Mounting through-hole Type Devices" and "Soldering", and use it after the confirmation, please.

Reliability Testing Result

Reliability Testing Result	Applicable Standard	Testing Conditions	Duration	Failure
Room Temp. Operating Life	EIAJ ED-4701/100(101)	Ta = 25°C, If = Maximum Rated Current	1,000 h	0/25
Resistance to Soldering Heat	EIAJ ED-4701/300(302)	260±5°C, 3mm from package base	10s	0/25
Temperature Cycling	EIAJ ED-4701/100(105)	Minimum Rated Storage Temperature(30min) ~Normal Temperature(15min) ~Maximum Rated Storage Temperature(30min) ~Normal Temperature(15min)	5 cycles	0/25
Wet High Temp. Storage Life	EIAJ ED-4701/100(103)	Ta = 60±2°C, RH = 90±5%	1,000 h	0/25
High Temp. Storage Life	EIAJ ED-4701/200(201)	Ta = Maximum Rated Storage Temperature	1,000 h	0/25
Low Temp. Storage Life	EIAJ ED-4701/200(202)	Ta = Minimum Rated Storage Temperature	1,000 h	0/25
Lead Tension	EIAJ ED-4701/400(401)	10N, 1time (□0.4 and Flat Package : 5N)	10s	0/10
Vibration, Variable Frequency	EIAJ ED-4701/400(403)	98.1m/s ² (10G), 100 ~ 2KHz sweep for 20min., XYZ each direction	2 h	0/10

Failure Criteria

Items	Symbols	Conditions	Failure criteria
Luminous Intensity	Iv	If Value of each product Luminous Intensity	Testing Min. Value < Spec. Min. Value x 0.5
Forward Voltage	V _F	If Value of each product Forward Voltage	Testing Max. Value ≥ Spec. Max. Value x 1.2
Reverse Current	I _R	V _R = Maximum Rated Reverse Voltage V	Testing Max. Value ≥ Spec. Max. Value x 2.5
Cosmetic Appearance	-	-	Occurrence of notable decoloration, deformation and cracking

Special Notice to Customers Using the Products and Technical Information Shown in This Data Sheet

- 1) The technical information shown in the data sheets are limited to the typical characteristics and circuit examples of the referenced products. It does not constitute the warranting of industrial property nor the granting of any license.
- 2) For the purpose of product improvement, the specifications, characteristics and technical data described in the data sheets are subject to change without prior notice. Therefore it is recommended that the most updated specifications be used in your design.
- 3) When using the products described in the data sheets, please adhere to the maximum ratings for operating voltage, heat dissipation characteristics, and other precautions for use. We are not responsible for any damage which may occur if these specifications are exceeded.
- 4) The products that have been described to this catalog are manufactured so that they will be used for the electrical instrument of the benchmark (OA equipment, telecommunications equipment, AV machine, home appliance and measuring instrument).
The application of aircrafts, space borne application, transportation equipment, medical equipment and nuclear power control equipment, etc. needs a high reliability and safety, and the breakdown and the wrong operation might influence the life or the human body. Please consult us beforehand if you plan to use our product for the usages of aircrafts, space borne application, transportation equipment, medical equipment and nuclear power control equipment, etc. except OA equipment, telecommunications equipment, AV machine, home appliance and measuring instrument.
- 5) In order to export the products or technologies described in this data sheet which are under the "Foreign Exchange and Foreign Trade Control Law," it is necessary to first obtain an export permit from the Japanese government.
- 6) No part of this data sheet may be reprinted or reproduced without prior written permission from Stanley Electric Co., Ltd.
- 7) The most updated edition of this data sheet can be obtained from the address below:
<http://www.stanley-components.com>