

POWER MANAGEMENT

Features

- VIN Range — 4.5V to 27V, VOUT Range — Up to 50V
- Step-up (Boost) Controller
 - Excellent Transient Response
 - Programmable Switching Frequency
- Linear Current Sinks
 - 8 Strings, up to 30mA/String
 - Current Matching $\pm 1\%$
 - Current Accuracy $\pm 1.5\%$
- PWM Dimming
 - String-by-String Phase Shifting
 - Input Dimming Frequency 100Hz-30kHz
 - User Selectable 9 or 10 Bits Dimming Resolution
 - Optional Synchronization to VSYNC/HSYNC Signal
- 5-bit Analog Dimming
- Optional External p-MOSFET Disconnect Switch
 - True Load Disconnect and Inrush Current Limiting
- I²C Interface
 - Fault Status — Open/Short LED, UVLO, OTP
 - Device Control — SYNC Freq, PLL Setting
- Protection Features
 - Open/Shorted LED(s) and adjustable OVP
 - Over-Temperature and UVLO Shutdown Protection
- 4 X 4(mm) 28-pin QFN Package

Applications

- Notebook PCs, UMPC, LCD Monitors, and Tablet PCs

Typical Application Circuit

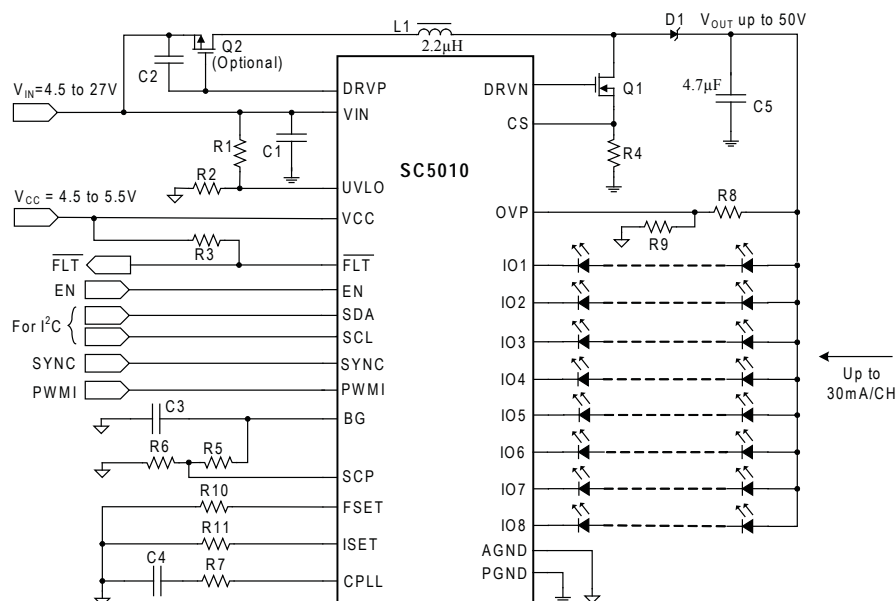

Description

The SC5010 is an 8-channel high-precision, high-efficiency step-up (Boost) LED driver for backlight applications. It features wide input voltage range (4.5V to 27V), flexible output configuration, wide analog and PWM dimming range, phase shifting and fading. It also features video signal synchronization (VSYNC), I²C interface, and numerous protection features. An optional disconnect p-MOSFET provides true load disconnection and inrush current limiting.

The boost controller, with programmable switching frequency from 200kHz to 2.2MHz, maximizes efficiency by dynamically minimizing the output voltage while maintaining LED string current accuracy. It provides excellent line and load response with no external compensation components. Each linear current sink is matched within $\pm 1\%$ for superb lighting uniformity, and the accuracy of each string current is $\pm 1.5\%$. An external resistor adjusts the current from 10-30mA per string. It also features PWM dimming resolution of 9 or 10 bits (user selectable) over dimming frequency from 100Hz to 20kHz, synchronized to the SYNC signal or the boost oscillator. String-by-string phase shifting reduces the demand on the input/output capacitance, decreases EMI, and improves dimming linearity.

SC5010 is available in a low-profile, thermally enhanced, 4 X 4 X 0.6(mm) QFN 28-pin package.

Pin Configuration

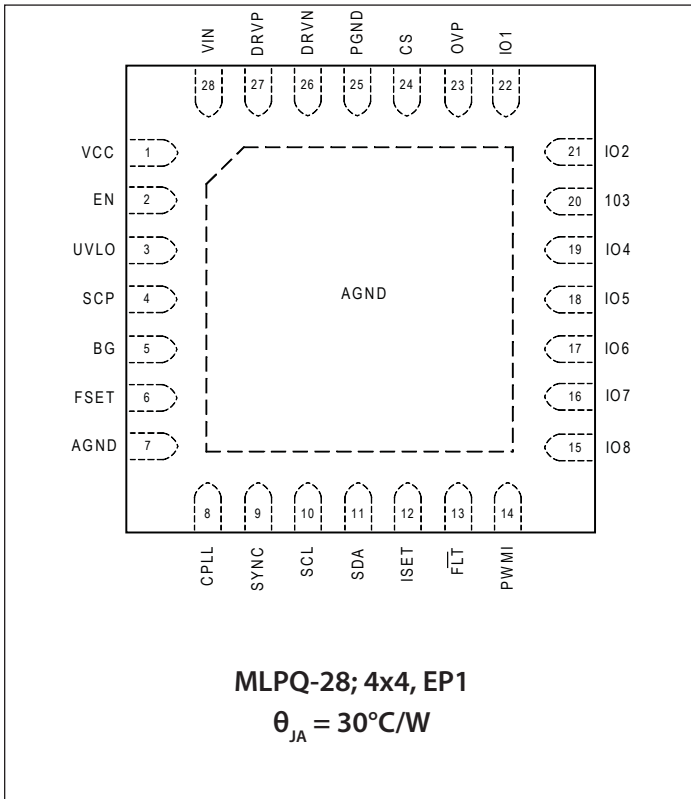

Ordering Information

Device	Package
SC5010ULTRT ⁽¹⁾⁽²⁾	MLPQ-UT-28 4x4
SC5010EVB	Evaluation Board

Notes:

- (1) Available in tape and reel only. A reel contains 3,000 devices.
- (2) Lead-free packaging only. Device is WEEE and RoHS compliant, and halogen-free.

Marking Information

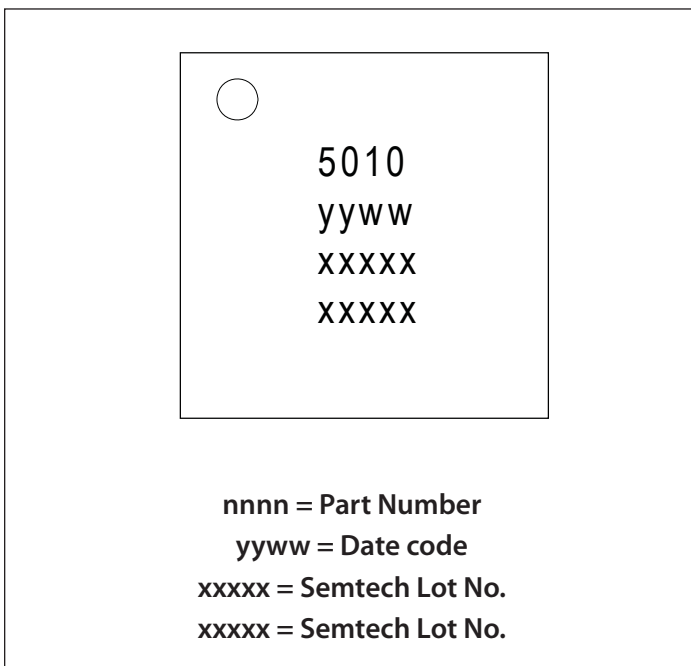

Absolute Maximum Ratings

VCC Pin (V)	-0.3 to +6.0
VIN, DRVP, IO1 to IO8(V)	-0.3 to +30
DRVN, OVP, CS, EN, UVLO, SCP, BG, \overline{FLT} (V) ...	-0.3 to +6.0
FSET, CPLL, SYNC, SCL, SDA, ISET, PWMI (V)..	-0.3 to +6.0
PGND TO AGND (V)	± 0.3
ESD Protection Level ⁽¹⁾ (kV)	2.5

Recommended Operating Conditions

Ambient Temperature Range (°C).....	$-40 \leq T_A \leq +85$
VIN (V)	4.5 to 27
IO1 to IO8 Current per String (mA)	up to 30

Thermal Information

Thermal Resistance, Junction to Ambient ⁽²⁾ (°C/W)	30
Maximum Junction Temperature (°C)	+150
Storage Temperature Range (°C).....	-65 to +150
Peak IR Reflow Temperature (10s to 30s) (°C)	+260

Exceeding the above specifications may result in permanent damage to the device or device malfunction. Operation outside of the parameters specified in the Electrical Characteristics section is not recommended.

NOTES:

- (1) Tested according to JEDEC standard JESD22-A114-B.
- (2) Calculated from package in still air, mounted to 3 x 4.5 (in.), 4 layer FR4 PCB with thermal vias under the exposed pad per JESD51 standards.

Electrical Characteristics

Unless noted otherwise, $T_A = 25^\circ\text{C}$ for typical, $-40^\circ\text{C} < T_A = T_J < 85^\circ\text{C}$ for min and max. $V_{CC} = 5\text{V}$, $R_{ISET} = 64.9\text{ k}\Omega$, $R_{FSET} = 100\text{ k}\Omega$, $V_{IN} = 12\text{V}$.

Parameter	Symbol	Conditions	Min	Typ	Max	Units
Input Supply						
V _{CC} Supply Voltage	V _{CC}		4.5		5.5	V
V _{CC} Under-Voltage Lockout Threshold	V _{CC-UVLO(TH)}	V _{CC} Voltage Rising	4.0	4.2	4.4	V
V _{CC} Under-Voltage Lockout Hysteresis	V _{CC-UVLO(HYS)}	V _{CC} Voltage Falling		180		mV
V _{CC} Quiescent Supply Current	I _{CC(Q)}	EN = 5V, Switching, No Load		2		mA
V _{CC} Supply Current in Shutdown	I _{CC(SD)}	EN = 0V			1	μA
V _{IN} Supply Current in Shutdown	I _{VIN(SD)}	EN = 0V, VIN = 27V			1	μA
V _{UVLO} Under-Voltage Lockout Threshold	V _{UVLO(TH)}	UVLO Pin Voltage Rising	1.18	1.23	1.28	V
I _{UVLO} Under-Voltage Lockout Hysteresis	I _{UVLO(HYS)}	UVLO Pin Voltage Falling	7	10	13	μA
V _{BG} Bandgap Voltage	V _{BG}		1.20	1.23	1.26	V
External FET Gate Drive						
DRVN High Level	V _{DRVN(H)}	100mA from DRVN to GND	V _{CC} -0.5	V _{CC} -0.2		V
DRVN Low Level	V _{DRVN(L)}	-100mA from DRVN to V _{CC}		0.2	0.5	V
DRVN On-Resistance	R _{DRVN}	DRVN high or Low		2	5	Ω
DRVN Sink / Source Current	I _{DRVN}	DRVN forced to 2.5V		1		A

Electrical Characteristics (continued)

Parameter	Symbol	Conditions	Min	Typ	Max	Units
Boost Converter						
CS Current Limit Threshold	$V_{CS(LIM)}$		0.36	0.40	0.44	V
Soft-start Time ⁽¹⁾	t_{SS}	From EN to end of soft start		4.4		ms
Boost Oscillator Frequency	F_{SW}	$R_{FSET} = 100k\Omega$	0.85	1	1.15	MHz
Boost Oscillator Frequency	F_{OSC}	R_{FSET} Varies	0.2		2.2	MHz
Maximum duty cycle	D_{MAX}		85	90		%
Output Disconnect Gate Drive						
DRVP Sink Current	$I_{DRVP(L)}$	DRVP = 12V		20		μA
DRVP clamp voltage	V_{CLAMP}	DRVP floating, $V_{CLAMP} = V_{IN} - V_{DRVP}$	5	7	8	V
DRVP Pin Leakage Current	I_{LEAK}	$V_{DRVP} = 27V, V_{EN} = 0V$		0.1	1	μA
Control Signals: EN, PWMI, SYNC, SDA, SCL						
High Voltage Threshold	V_{IH}	$V_{CC} = 4.5V$ to $5.5V$	2.1			V
Low Voltage Threshold	V_{IL}	$V_{CC} = 4.5V$ to $5.5V$			0.8	V
SDA Output Low	$V_{SDA(L)}$	-6mA from V_{CC} to SDA			0.3	V
Pin Leakage Current	I_{LEAK}	$V_{EN} = 0V, V_{VSYNC} = V_{PWMI} = V_{ISET} = V_{FSET} = V_{SDA} = V_{SDL} = 5.0V$	-1		1	μA
PWM Dimming Input						
PWMI Input Dimming Frequency	F_{PWMI}		100		30k	Hz
SYNC Input Frequency	F_{SYNC}		30		100k	Hz
PWMI Input Resolution		$100Hz < F_{PWMI} < 10kHz$		10		bits
		$10kHz < F_{PWMI} < 20kHz$		9		bits
Over-Voltage Protection						
OVP Trip Threshold Voltage	$V_{OVP(TRIG)}$	OVP Rising	1.1	1.2	1.3	V
OVP Hysteresis	$V_{OVP(HYS)}$	OVP Falling		10		mV
OVP Leakage Current	$I_{OVP(LEAK)}$	OVP = 5V		0.1	1	μA

Electrical Characteristics (continued)

Parameter	Symbol	Conditions	Min	Typ	Max	Units
Current Sink (IO1 to IO8)						
IOx Dimming Minimum Pulse Width	$T_{PWM(MIN)}$	$F_{PWM(LED)} = 100\text{Hz} - 30\text{kHz}$		300		ns
ISET pin voltage	V_{ISET}			1.23		V
Regulation Voltage	$V_{IOn(REG)}$	Voltage of Regulating String		0.6		V
Current Sink Disable Threshold	$V_{IOn(DIS)}$	Checked at Power-up	0.6			V
Current Sink Rise/Fall Time ⁽¹⁾	$t_{RISE/FALL}$	Rising edge from 10% to 90% of $I_{O(n)}$		25		ns
LED Current Accuracy	$I_{On(ACC\%)}$	PWMI = 100%, $T_A = +25^\circ\text{C}$	19.7	20	20.3	mA
LED Current Matching ⁽²⁾	$I_{On(MATCH)}$	PWMI = 100%, $T_A = +25^\circ\text{C}$			± 1	%
		PWMI = 100%, $T_A = -40^\circ\text{C}$ to $+85^\circ\text{C}$			± 2	%
I_{On} Off Leakage Current	$I_{On(LEAK)}$	PWMI = 0V, EN = 0V, $V_{IO1} \sim V_{IO8} = 25\text{V}$		0.1	1	μA
IO Switching Frequency	$F_{PWM(IO)}$	FAST_FREQ = 0		10		kHz
		FAST_FREQ = 1 (Default Setting)		20		
Phase Delay Time between IO Pins (IO1 to IO8)	t_{PD}	FAST_FREQ = 1 (default setting) $t_{PD} = (1/8) * (1/F_{PWM(IO)})$, 8 Strings On		6.25		μs
PWM Output Resolution		$F_{PWM(IO)} = 10\text{kHz}$		10		bits
		$F_{PWM(IO)} = 20\text{kHz}$		9		
Fault Protection						
LED Short Circuit Protection Threshold	$V_{IOn(SCP)}$	R_4 and R_5 ⁽³⁾	$17xV_{SCP}$	$20xV_{SCP}$	$23xV_{SCP}$	V
LED Open Circuit Protection Threshold	V_{IO_OCP}			0.2		V
LED Short Circuit Fault Delay	$t_{SCP(DELAY)}$	V_{OVP} set to 1.5V, \overline{FLT} goes low		1		μs
\overline{FLT} Pin Leakage Current	$I_{\overline{FLT}(LEAK)}$	$V_{EN} = 0\text{V}$, $V_{\overline{FLT}} = 5.0\text{V}$	-1		1	μA
\overline{FLT} Output Low	$V_{\overline{FLT}(LOW)}$	-5mA from \overline{FLT} to V_{CC}			0.3	V
Over-Temperature Protection						
Thermal Shutdown Temperature				150		$^\circ\text{C}$
Thermal Shutdown Hysteresis				10		$^\circ\text{C}$

Electrical Characteristics (continued)

Parameter	Symbol	Conditions	Min	Typ	Max	Units
I²C Control Interface: SDA, SCL Timing Specifications						
SCL Clock Frequency	F_{SCL}				400	kHz
SCL Clock Low Period	$t_{LOW(SCL)}$		1.3			μ s
SCL Clock High Period	$t_{HIGH(SCL)}$		0.6			μ s
Hold Time Start Condition	$t_{HD(START)}$		0.6			μ s
SDA Setup Time	$t_{SU(SDA)}$		100			ns
SDA Hold Time	$t_{HD(SDA)}$		0		0.9	μ s
Setup Time Stop Condition	$t_{SU(STOP)}$		0.6			μ s
Bus Free Time between Stop & Start	t_{BF}		1.3			μ s

Notes:

- (1) Ensured by design and characterization, not production tested
- (2) LED current matching for 8 channels is defined as the largest of the two numbers, i.e., $(MAX-AVG)/AVG$ and $(AVG-MIN)/AVG$; where MAX is the maximum of LED channel current, MIN is the minimum LED channel current and AVG is the average of the 8 LED channel current.
- (3) Refer to the detailed application circuit on page 21.

Typical Characteristics

Backlight Efficiency vs. Input Voltage

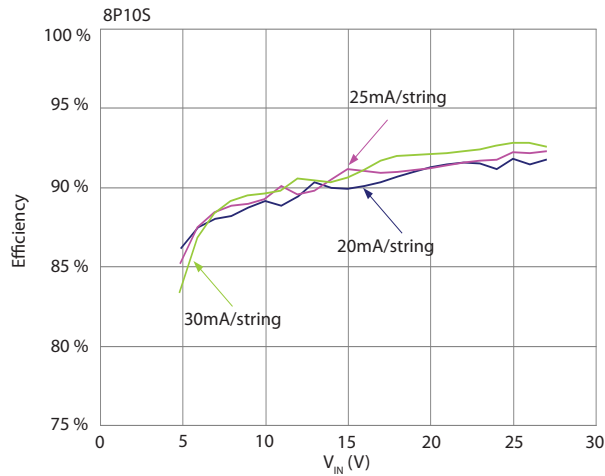

Backlight Efficiency vs. Input Voltage

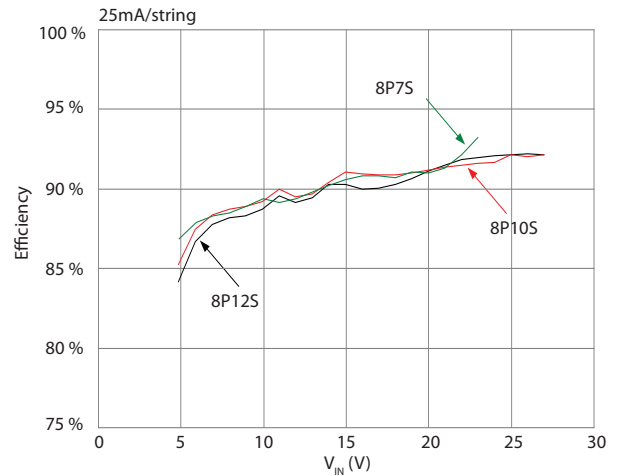

Backlight Efficiency vs. LED String Current

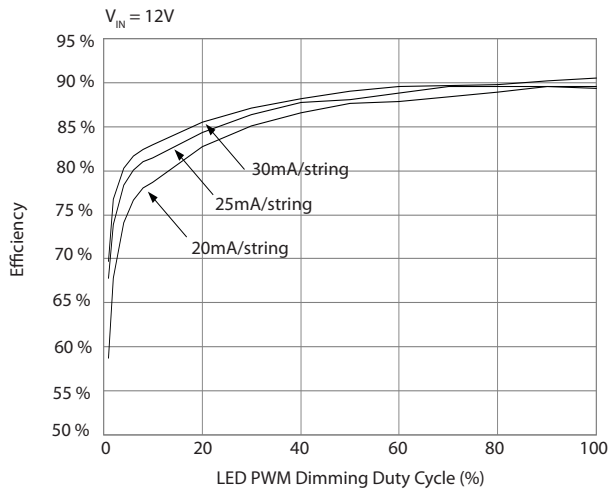

Backlight Efficiency vs. LED String Current

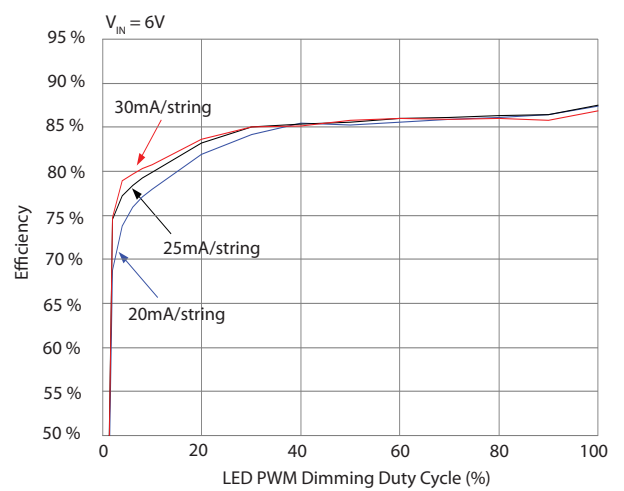

PWM Dimming Linearity with Phase Shift

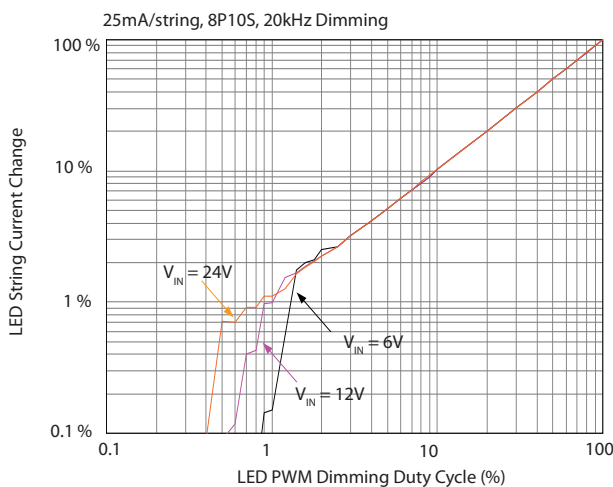

PWM Dimming Linearity with Phase Shift

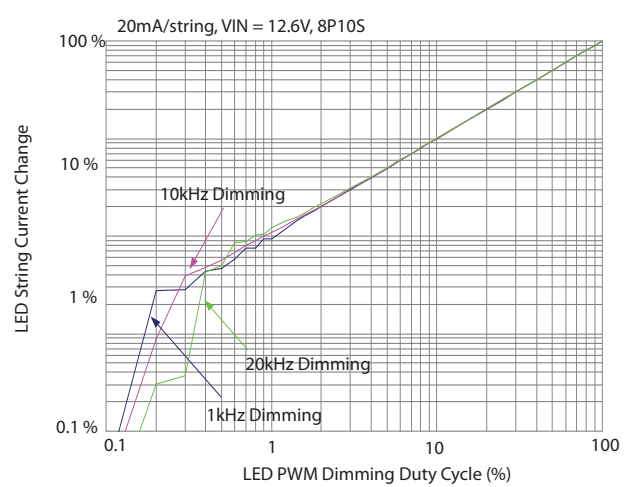

Typical Characteristics (continued)

LED String Current Matching vs. Temperature

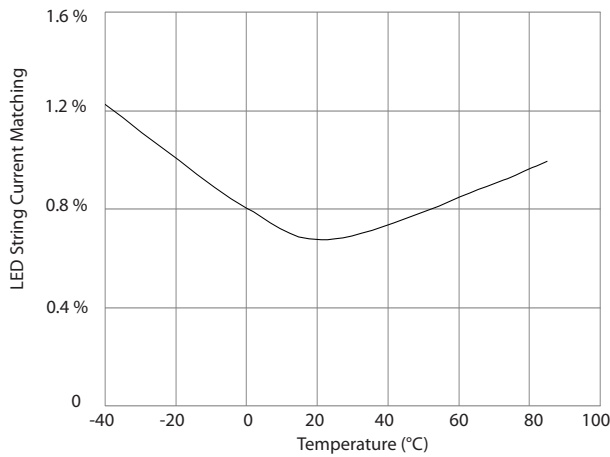

LED String Current vs. R_{ISET}

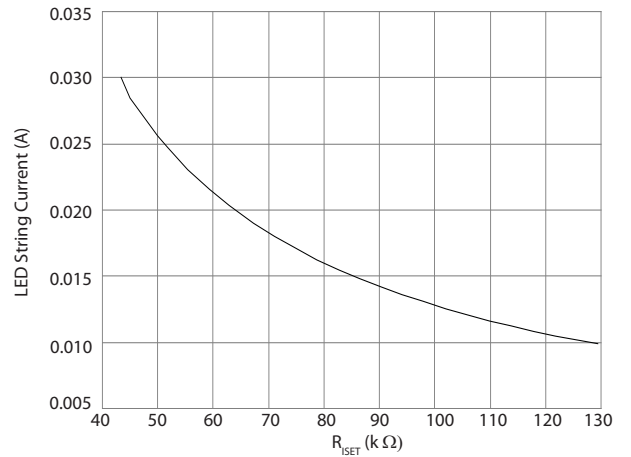

Switching Frequency vs. R_{FSET}

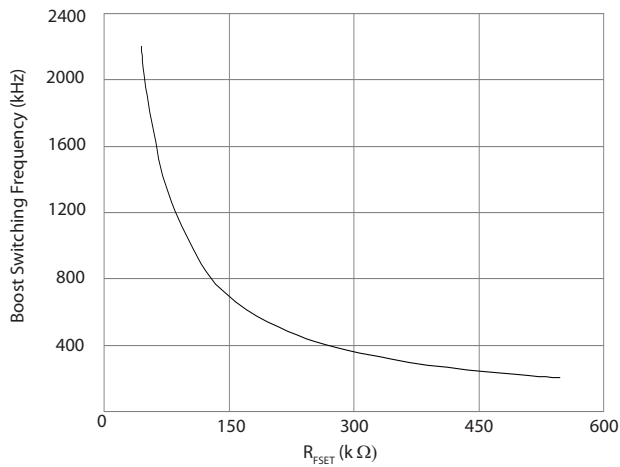

V_{BG} vs. Temperature

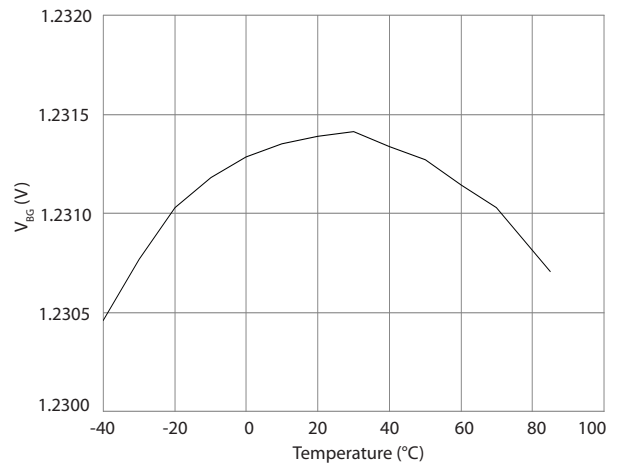

LED String Current Change vs. Analog Dimming Control Register (IDAC) Value

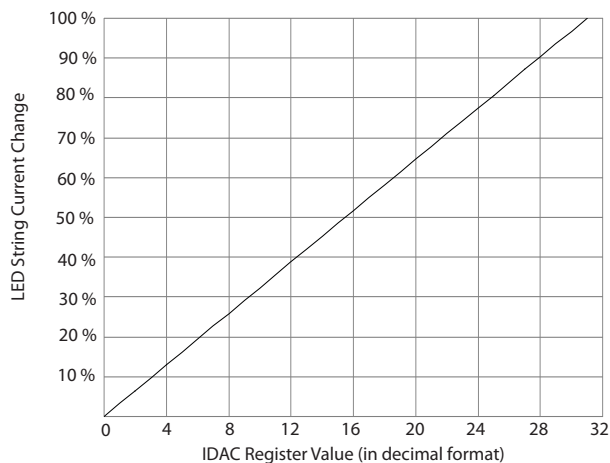

LED String Current Matching vs. Analog Dimming Control Register (IDAC) Value

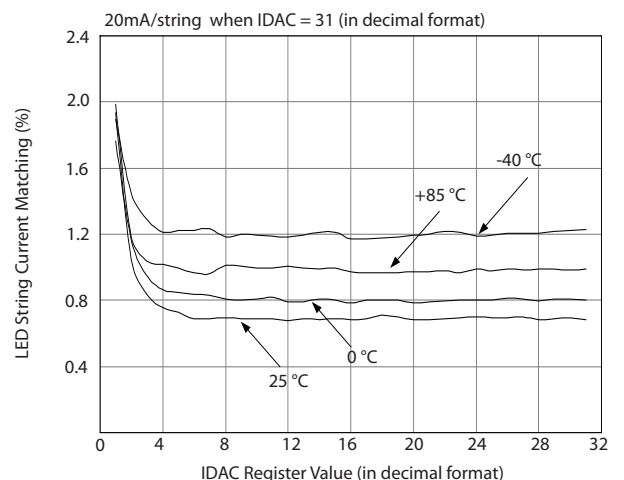

Typical Characteristics (continued)

LED Current Fade In/Out (Logarithmic)

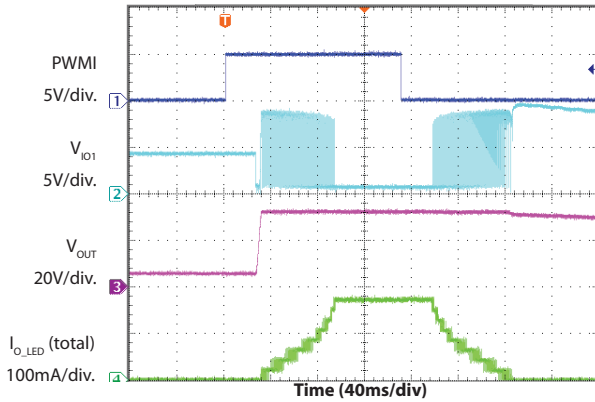

LED Current Fade In/Out (Linear)

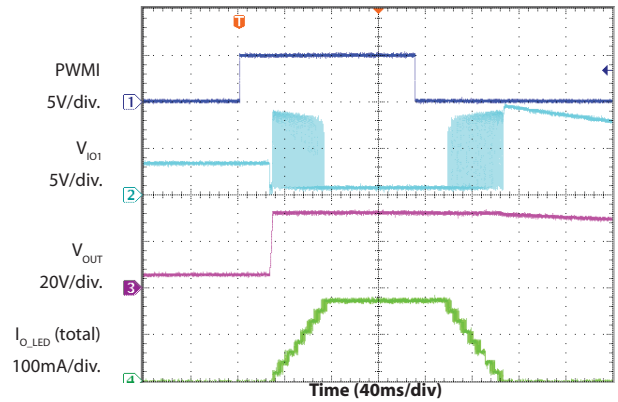

Line Transient Response

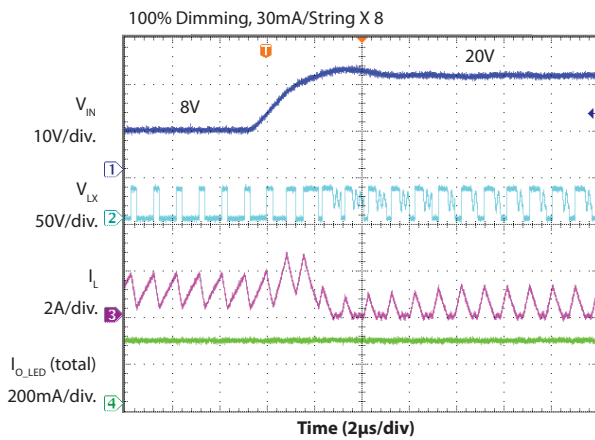

LED Open Circuit Protection

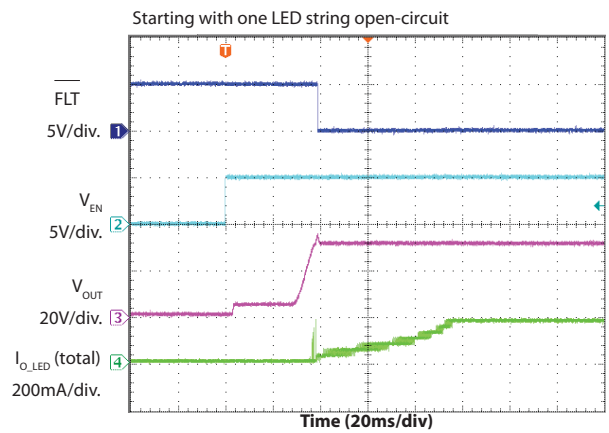

Load Transient Response

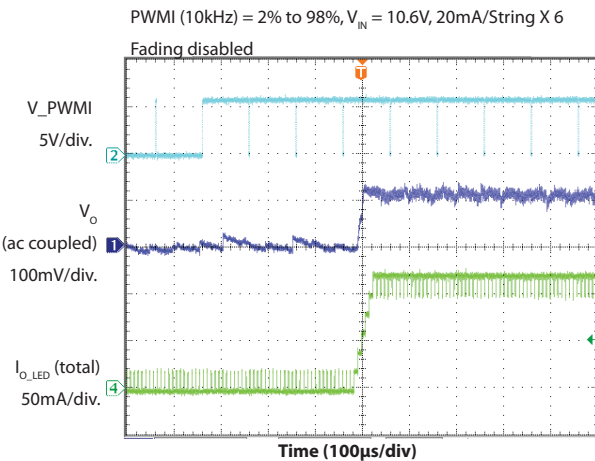

Load Transient Response

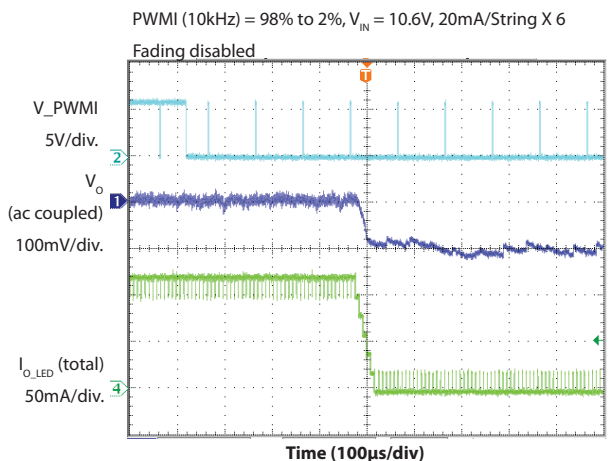

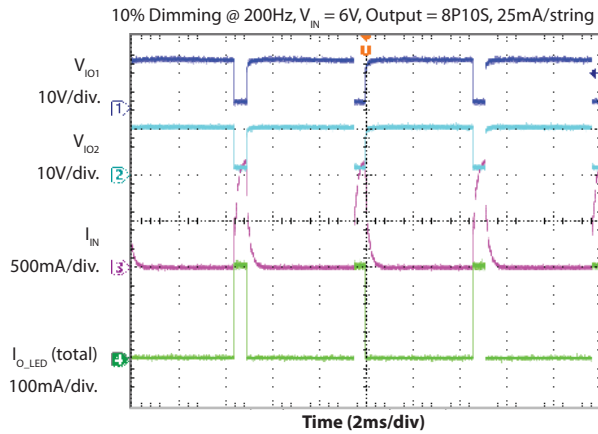
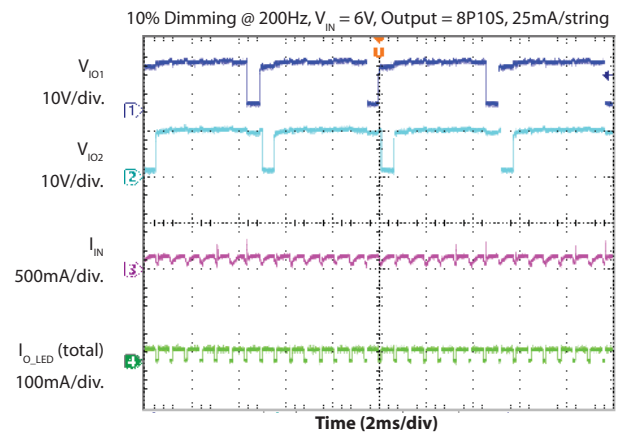
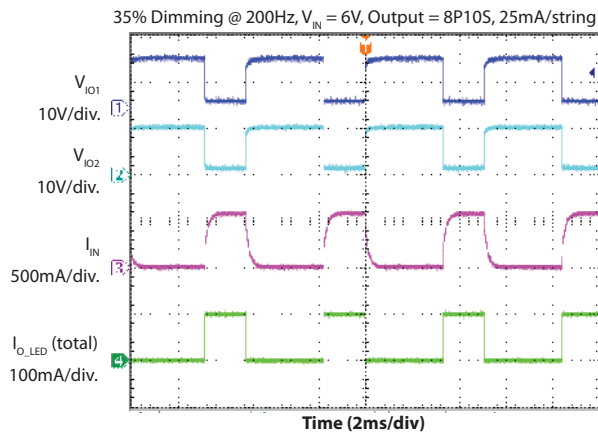
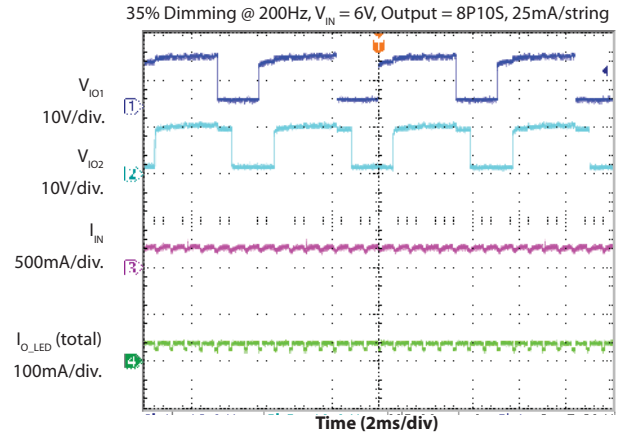
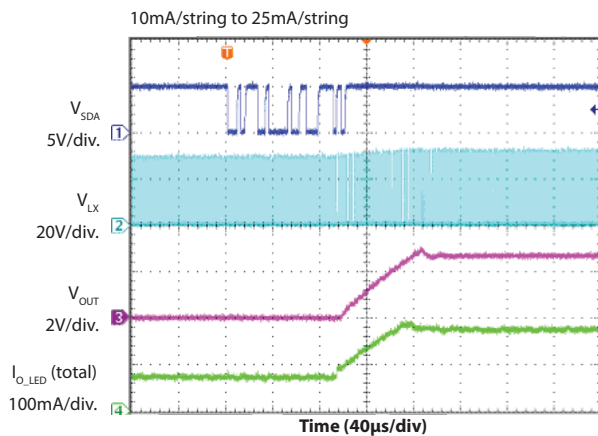
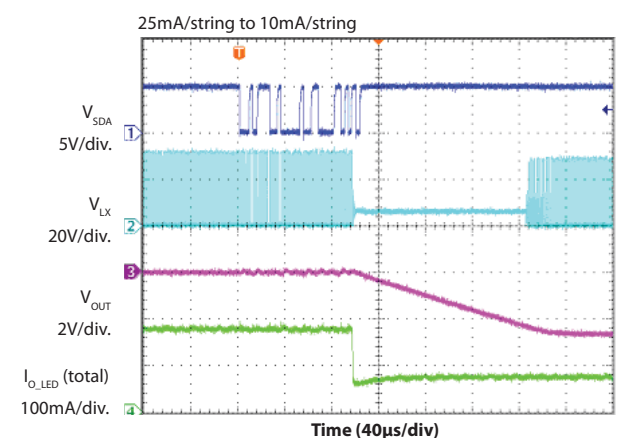
Typical Characteristics (continued)
LED Dimming Without Phase Shift

LED Dimming With Phase Shift

LED Dimming Without Phase Shift

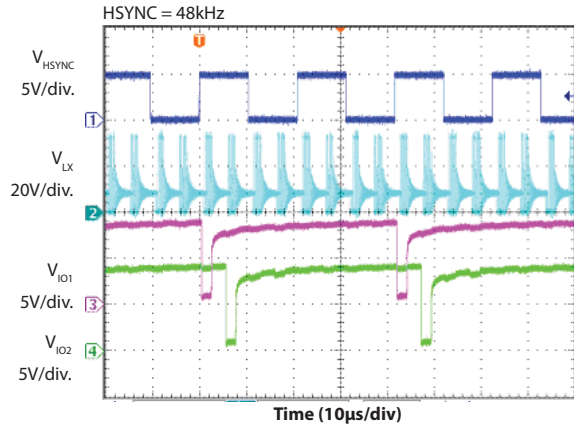
LED Dimming With Phase Shift

Analog Dimming Transient via I²C

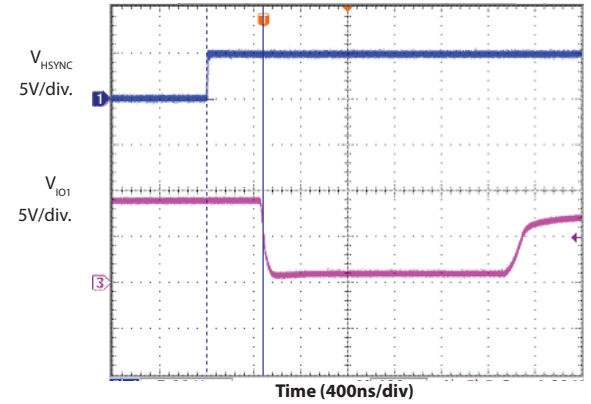
Analog Dimming Transient via I²C

Typical Characteristics (continued)

Synchronization of the LED Dimming to An External HSYNC Input



Delay Between HSYNC Rising Edge and Turn-on of LED String 1



VIN Start Up

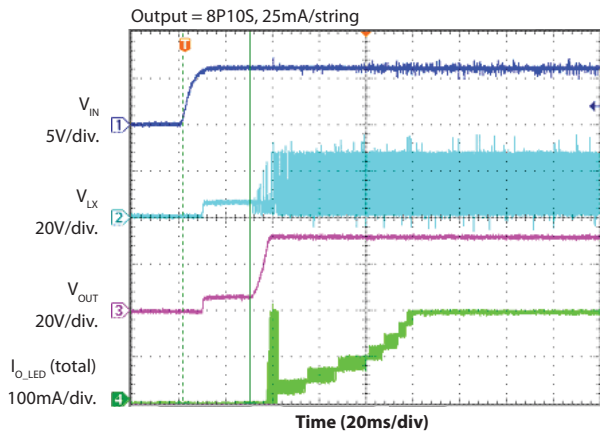

LED String Current Accuracy vs. Temperature

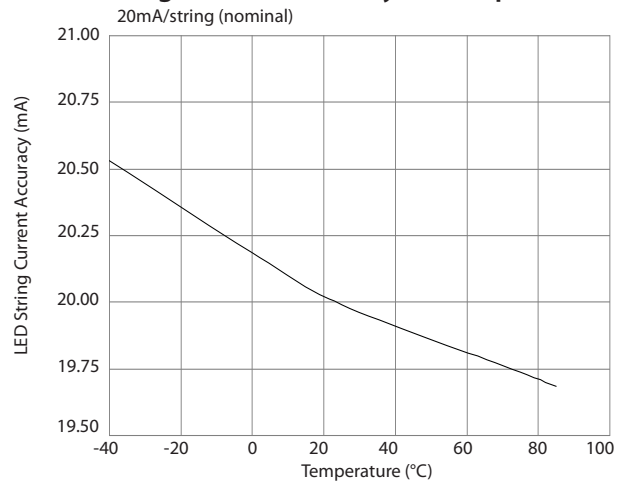

Pin Descriptions

Pin #	Pin Name	Pin Function
1	VCC	Input bias voltage supply for the IC — accepts 4.5-5.5V inputs. Add a 1 μ F or larger ceramic bypass capacitor from this pin to ground.
2	EN	Logic high enable pin — pull logic high to enable the device or pull low to disable and maintain low shutdown current.
3	UVLO	Input under-voltage lockout pin — Device is disabled when this pin is less than 1.23V (nominal). Add a resistor divider from this pin to the input voltage and AGND, respectively.
4	SCP	Short circuit LED protection programming pin. Shorted LED protection disables the individual channel when the current sink voltage exceeds the programmed voltage threshold. Adding resistor divider from this pin to BG and AGND programs the shorted-LED protection up to 20x the V_{SCP} voltage. Pulling the pin high to VCC disables the SCP feature on all channels.
5	BG	1.23V bandgap output pin — Connect a 1 μ F ceramic bypass capacitor from this pin to ground.
6	FSET	Step-up (boost) frequency set pin — Connect a resistor from this pin to ground to set the frequency from 200kHz to 2.2MHz.
7	AGND	Analog ground pin — tie this pin to analog (quiet) ground isolated from the step-up (boost) converter switching current path.
8	CPLL	Compensation for the internal PLL — connect a compensation resistor and capacitor from this pin to ground. This pin can be left floating if not used.
9	SYNC	SYNC input pin — feeding the SYNC signal (30Hz - 100kHz) to this input results in internal PLL being synchronized to the SYNC signal. This pin can be left floating if not used.
10	SCL	I ² C serial clock input — this pin must be connected to ground if not used.
11	SDA	I ² C serial data input — this pin must be connected to ground if not used.
12	ISET	LED current programming pin — connect an external resistor to ground to program the current in the LED strings. For more details please refer to LED String Peak Current Programming on page 15.
13	$\overline{\text{FLT}}$	Logic low fault status pin — open-drain output is latched low when fault condition is detected: Open/Short LED, Shorted String, OVP or OTP. Fault status can be reset by removing fault condition(s) and toggling the EN, VCC or UVLO pins. This pin can be left floating if not used.
14	PWMI	PWM dimming control input
15	IO8	Regulated current sink LED channel 8 — connect this pin to the cathode of the bottom LED in string 8. Connect pin to ground to disable this LED string.
16	IO7	Regulated current sink LED channel 7 — connect this pin to the cathode of the bottom LED in string 7. Connect pin to ground to disable this LED string.
17	IO6	Regulated current sink LED channel 6 — connect this pin to the cathode of the bottom LED in string 6. Connect pin to ground to disable this LED string.
18	IO5	Regulated current sink LED channel 5 — connect this pin to the cathode of the bottom LED in string 5. Connect pin to ground to disable this LED string.
19	IO4	Regulated current sink LED channel 4 — connect this pin to the cathode of the bottom LED in string 4. Connect pin to ground to disable this LED string.

Pin Descriptions (continued)

Pin #	Pin Name	Pin Function
20	IO3	Regulated current sink LED channel 3 — connect this pin to the cathode of the bottom LED in string 3. Connect pin to ground to disable this LED string.
21	IO2	Regulated current sink LED channel 2 — connect this pin to the cathode of the bottom LED in string 2. Connect pin to ground to disable this LED string.
22	IO1	Regulated current sink LED channel 1 — connect this pin to the cathode of the bottom LED in string 1. Connect pin to ground to disable this LED string.
23	OVP	Over-voltage feedback pin — over-voltage activated when pin exceeds 1.2V. Use a resistor divider tied to the output and GND to set the OVP level.
24	CS	Step-up (boost) switch current sense pin — Connect a resistor from this pin to ground for current sense - utilized in peak current mode control loop and over-current sense circuitry.
25	PGND	Power ground — tie this pin to the power ground plane close to input and output decoupling capacitors.
26	DRVN	Gate drive for the external step-up (boost) n-channel MOSFET.
27	DRVP	Gate drive for the external p-channel MOSFET disconnect switch.
28	VIN	Connect to the input power supply — accepts 4.5V - 27V input. Usually add 4.7μF or larger ceramic bypass capacitor from this pin to ground.
PAD	-	Thermal pad for heat-sinking purposes — it is also AGND and should be connected to ground plane for proper circuit operation.

Block Diagram

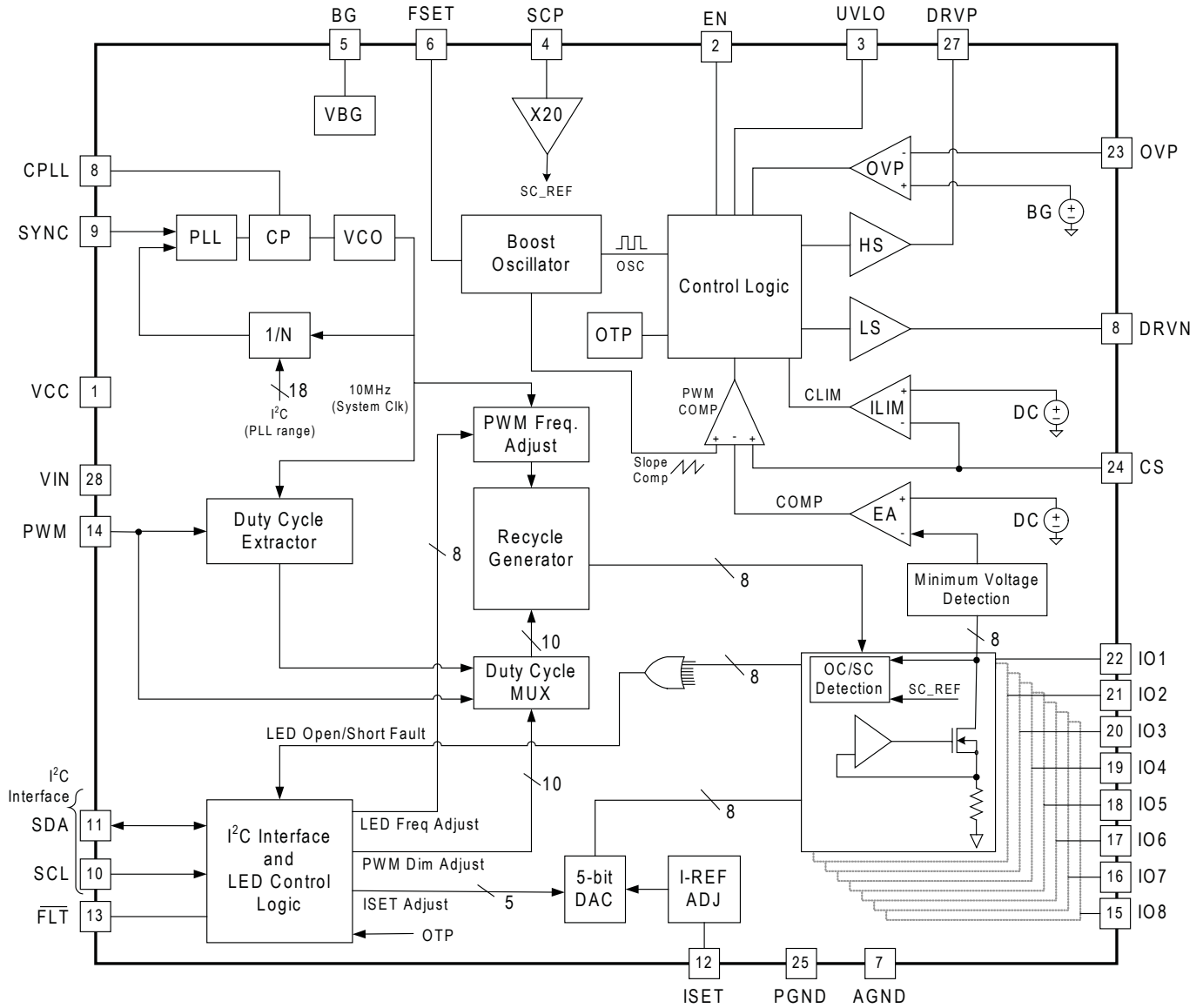

Applications Information

General Description

The SC5010 contains a high frequency, current-mode, internally compensated boost controller and eight constant current sinks for driving LED strings. The LED current for all strings is programmed by an external resistor and the boost converter operates to maintain minimal required output voltage for regulating the LED current to the programmed value. A typical backlight application uses 3 to 14 LEDs for each string, with current driven up to 30mA. The unique control loop of the SC5010 allows fast transient response in dealing with line and load disturbances. The SC5010 operating with an external power MOSFET regulates the boost converter output voltage based on instantaneous requirement of the eight string current sources. This provides power to the entire lighting subsystem with increased efficiency and reduced component count. It supports PWM dimming frequencies from 100Hz to 30kHz and the supply current is reduced to typical 2mA when all LED strings are off.

Start-Up

When the EN pin is pulled up high (>2.1V), the device is enabled and the UVLO and VCC pin voltages are checked. The VCC voltage has fixed under-voltage rising and falling trip points. If the VCC pin is higher than 4.2V and UVLO pin voltage is greater than 1.23V, the SC5010 goes into a startup sequence. The UVLO pin voltage can be used to program the input power source voltage VIN turn on threshold and its hysteresis (refer to the Detailed Application Circuit on page 21) as shown by the following equations:

$$V_{IN_TurnOn} [V] = 1.23 \times (R_1 + R_2) / R_1$$

$$V_{IN_Hysteresis} [V] = 10^{-5} \times R_2 [\Omega]$$

In the next phase, the SC5010 checks each IO pin to determine if the respective LED string is enabled. Each IO pin is pulled up with a 100µA current source. If any IO pin is connected to GND, it will be detected as an unused string, and will be turned off. This unused string checking procedure takes 1ms (typical). After this the SC5010 enters into a soft-start sequence.

The soft-start function helps to prevent excess inrush current through the input rail during startup. In the

SC5010, the soft-start is implemented by slowly ramping up the reference voltage fed to the error amplifier. This closed loop start-up method allows the output voltage to ramp up without any overshoot. The duration of the soft-start in SC5010 is controlled by an internal timing circuit which is used during start-up and it's based on the boost converter switching frequency. For example, with switching frequency at 1MHz, it is typical 8ms and it becomes typical 4ms when the switching frequency is 2MHz.

If PWMI voltage goes low while the SC5010 is in soft start operation, the SC5010 switches to standby mode. Under such mode, the external power MOSFET and the LED current sources will be turned off immediately. The internal soft-start timer is turned off and the soft-start value is saved. When the PWMI voltage goes high again, the soft-start resumes from the previously saved value.

Each LED current source (IO1 to IO8) tries to regulate the LED current to its set point. The control loop will regulate the output voltage such that all the IO pin voltages are at least typical 0.6V.

Shutdown

When the EN pin is pulled down below 0.8V, the device enters into shutdown mode. In this mode, all the internal circuitry is turned off and the supply current is less than 1µA(max).

In the scenario when the EN pin voltage is high, but either V_{IN} or VCC voltage falls below their respective UVLO threshold, the SC5010 goes into a suspend mode. In this mode, all the internal circuitry except the reference and the oscillator are turned off.

Thermal Shutdown (TSD)

If the thermal shutdown temperature of 150°C is reached, the boost converter and all IO current sources are turned off. \overline{FLT} pin is forced low in this situation. As temperature falls below the TSD trip point by 10°C, the SC5010 will restart following the startup sequence as described before. The \overline{FLT} pin is latched and will stay low, it is reset by cycling the EN, VCC, or UVLO.

Applications Information (continued)

Boost Converter Operation

The SC5010 includes a boost controller with programmable switching frequency. It applies current-mode control method with integrated compensation loop. The clock (see block diagram) from the oscillator sets the latch and turns on the external power MOSFET, which serves as the main power switch. The current flowing through this switch is sensed by the current sense resistor in series with the switch. The sensed switch current is summed with the slope-compensated ramp and fed into the modulating input of the PWM comparator. When the modulating ramp intersects the error amplifier output (COMP), the latch is reset and the power MOSFET is turned off. The sense resistor also sets the peak current limit of the power MOSFET, I_{OCP} using the following equation:

$$I_{OCP} [A] = 0.4 / R_{CS} [\Omega]$$

The current-mode control system contains two loops. For the inner current loop, the Error Amplifier (EA) output (COMP) controls the peak inductor current. In the outer loop, the EA regulates the output voltage for driving the LED strings.

Boost Converter Switching Frequency Selection

The resistor between FSET and GND sets the boost converter switching frequency (200kHz to 2.2MHz) using the following equation:

$$f_{SW} [kHz] = 10^5 / R_{FSET} [k\Omega]$$

Higher switching frequency allows the use of low profile height inductor for space-constrained and cost-sensitive applications.

Over-Voltage Protection (OVP)

SC5010 features programmable output over-voltage protection preventing damage to the IC and output capacitor in the event of LED string open-circuit. The boost converter output voltage is sensed at the OVP pin through resistor voltage divider. The OVP trip threshold (refer to detailed application circuit on page 21) can be calculated using the following equation.

$$\text{Output OVP Trip Voltage [V]} = 1.2 \times (R_{11} + R_{10}) / R_{10}$$

When the OVP pin voltage exceeds 1.2V, the boost converter turns off and the \overline{FLT} pin is pulled low. When the OVP pin voltage falls below the OVP threshold (falling), the boost converter restarts and the \overline{FLT} pin is released. There is 10mV hysteresis between OVP pin threshold (falling) and OVP pin threshold (rising). This results in an output voltage hysteresis given by:

$$\text{Output OVP Hysteresis[mV]} = 10 \times (R_{11} + R_{10}) / R_{10}$$

LED Current Sink

The SC5010 provides 8 current sinks and each can sink up to 30mA current. It incorporates LED string short-circuit protection (trip level programmable and can be disabled as well), LED string open-circuit protection.

LED String Peak Current Programming

LED string peak current (at 100% dimming) can be set by selecting resistor R_{ISET} connected between ISET and GND. The relationship between R_{ISET} resistance and single LED string peak current is calculated using the following equation:

$$I_{LED} [mA] = (1055 \times 1.23) / R_{ISET} [k\Omega]$$

The LED string current can be programmed up to 30mA.

Unused Strings

The SC5010 may be operated with less than 8 strings. In this mode of operation, all unused IO pins should be connected to ground. During startup, these unused strings are detected and disabled while other active strings work normally.

LED Short-Circuit Protection (SCP)

SC5010 features a programmable LED short protection. This allows the part to be customized based on the LED V_F mismatches between the LED strings. If one or more LEDs are detected as short-circuited, the corresponding string will be latched off. The voltages on all IO pins are monitored to check if any IO pin exceeds the SCP trip point (The IO voltage for LED string with faulty short-circuit LED(s) will be higher than other normal IO pin voltages). This LED Short-Circuit Protection (SCP) trip level (see detailed application circuit on page 21) is given by the following equation.

$$V_{SCP_Trip} [V] = 20 \times (1.23 \times R_4) / (R_4 + R_5)$$

Applications Information (continued)

If any IO pin voltage exceeds the trip voltage, the IO current sink will be latched off and the $\overline{\text{FLT}}$ will go low. This latch can be reset by cycling UVLO, VCC or EN. Other LED strings are unaffected and continue in normal operation. This protection will be disabled if SCP is tied to VCC.

In many applications, LED strings are connected to the IO pins through a mechanical connector which cannot support an electrical connection at specific times. This connection might cause noise on the IO pins. If this noise is large enough, it may trigger false SCP mode. In this condition, a ceramic decoupling capacitors (100pF ~ 8.2nF) between IO pin to GND can help prevent the SC5010 from entering the protection mode by false trigger. This feature can be disabled by connecting SCP pin to VCC pin.

LED Open-Circuit Protection

If any LED string becomes open, the respective IO pin voltage will be pulled to GND. Consequently, the internal COMP node (output of error amplifier) is driven high, which causes the boost output voltage to increase. The output voltage will be eventually clamped to a voltage set by the OVP resistor divider. Under this condition, the faulty string is latched off and the $\overline{\text{FLT}}$ pin is pulled low. The boost voltage gets regulated to the voltage required to set all non-faulty IO pins above 0.6V (typ). The remaining strings remain in normal operation. The $\overline{\text{FLT}}$ and the fault-out LED current sink latch-off can be reset by cycling UVLO, VCC or EN.

LED Analog Dimming Control

The LED current in SC5010 can be dimmed via the 5-bit analog dimming register (Register 0x02). The LED current can be adjusted in 32 steps from 0mA to the maximum value, determined by the R_{SET} resistor.

SC5010 has a unique DAC architecture which allows it to have excellent LED current accuracy and string-to-string matching over the entire DAC range.

Analog dimming method can be used in conjunction with PWM dimming to increase the dimming resolution. The fast loop response of SC5010 allows the LED current to transition to a new value within 100 μ s or so. Please refer to the graphs in the typical characteristics section.

LED PWM Dimming Control

The SC5010 supports 3 modes of PWM dimming for controlling the brightness of the LEDs. It provides flexibility in setting the duty cycle and frequency of the LED PWM signal. The PWM dimming mode is set through the device control register (register address: 0x01) DCR [1:0] bits. Refer to Table 1 for more details.

Mode 1 — PWMI Direct Control

The PWMI input needs to be held high for normal operation. PWM dimming can be done by cycling the PWMI input at a given frequency where a “low” on the PWMI input turns off all IO current sinks and a “high” turns on all IO current sinks. The PWMI pin can be toggled by external circuitry to allow PWM dimming. In a typical application,

Table 1 — LED PWM Dimming Control Methods

PWM Dimming Mode	Register Settings DCR[1:0]	PWM Input Source	LED PWM Output		Phase Shift Option
			PWM Frequency	PWM Duty Cycle	
PWMI Direct Control	00	PWMI Pin Input	Same as the PWMI input (Range 100 Hz to 30kHz)	Same as the PWMI input	NO
PWMI Indirect Control (Default Option)	01	PWMI Pin Input	Set via the FREQ Register (0x05) and FAST_FREQ bit 10kHz (max): FAST_FREQ=0 20kHz(max): FAST_FREQ=1	Same as the duty cycle of the PWMI input 10 bits @ 10kHz output 9 bits @ 20kHz output	YES
I ² C Control	11	I ² C Control	Set via the FREQ Register (0x05) and FAST_FREQ bit 10kHz (max): FAST_FREQ=0 20kHz(max): FAST_FREQ=1	Set via the Duty Cycle Control Register (0x03, 0x04) 10 bits @ 10kHz output 9 bits @ 20kHz output	YES

Applications Information (continued)

a micro-controller sets a register or counter that varies the pulse width on a GPIO pin. The SC5010 allows dimming over a wide frequency range (100Hz-30kHz) in order to allow compatibility with a wide range of devices. This includes the newest dimming strategies that avoid the audio band by using high frequency PWM dimming. In this manner, a wide range of illumination can be generated while keeping the instantaneous LED current at its peak value for high efficiency and color temperature. The SC5010 provides 1000:1 dimming range at 1kHz PWM frequency. The LED current sinks turn on /off very rapidly (<25ns, typical). This allows wide dimming ratio. An additional advantage of PWM dimming comes to customers who prefer to avoid in-rush currents when filling the boost output capacitor. Apply the PWMI signal to the device at 10% duty for a millisecond or two, and in-rush current is reduced. This dimming time will vary based on the number of LEDs and the size of the output capacitor. This can be easily determined during testing and programmed into the micro-controller firmware.

Mode 2 — Indirect Control

This is the default mode for LED PWM dimming in SC5010. In this mode, the input signal applied on PWMI pin is passed through a duty cycle extractor block. The extractor mea-

sures the duty cycle of the PWMI input and converts it to a 10-bit value. This value is then passed to the PWM generator block as shown in the Figure 1 below.

The LED PWM output frequency is set via the FREQ register (address 0x05) and the FAST_FREQ bit.

With FAST_FREQ = 0, low dimming frequency option is selected and the PWM dimming frequency will be according to the following equation.

$$\text{PWM Dimming Frequency} = \frac{10\text{MHz}}{1024 \times [\text{FREQ}[7:0] + 1]} = 10\text{kHz}(\text{max})$$

With FAST_FREQ = 1, high dimming frequency option is selected and the PWM dimming frequency is shown by the following equation.

$$\text{PWM Dimming Frequency} = \frac{10\text{MHz}}{512 \times [\text{FREQ}[7:0] + 1]} = 20\text{kHz}(\text{max})$$

The default option is FAST_FREQ = 1. This gives 9-bit duty cycle resolution and up to 20kHz dimming frequency range. The PWMI input is usually generated by the system graphics processor. This mode allows the user to set the

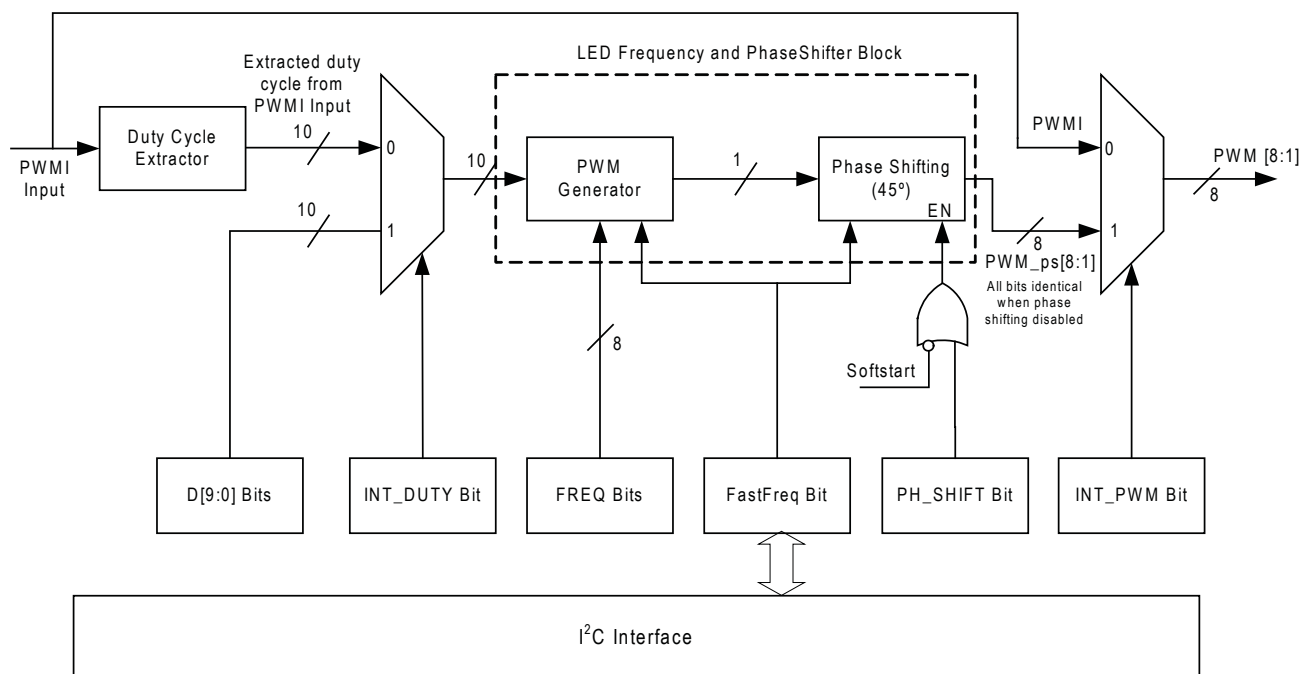

Figure 1— LED PWM Dimming Control

Applications Information (continued)

PWM output dimming frequency independent of the PWMI input.

If the PWMI signal has jitter, then SC5010 provides an option to filter it out. Hysteresis is also provided by selecting the WND[1:0] bits in the DCR register (address 0x01). WND[1:0] bits set the window comparator such that if a change in the duty cycle is detected which is smaller than the set window, then it is ignored.

Mode 3 — I²C Control

In this mode (see Figure 1), both the output LED duty cycle and the dimming frequency are set via the internal registers. PWMI pin should be connected to ground in this mode. In this mode, the LED dimming duty cycle is set via the duty cycle registers (address 0x03, 0x04); and the dimming frequency is set via the FREQ register (address 0x05) and the FAST_FREQ bit.

Phase-Shifted PWM Dimming

The SC5010 provides an option for the phase shifted LED PWM dimming. This option is available in both PWMI indirect control and I²C control. Phase-shift option is set by the PH_SHIFT bit in the DCR register. This option delays the turn-on of the LED strings based on the number of the strings in operation. It is shown by the following equation.

$$T_{\phi\text{-phase}} = \frac{1}{N f_{\text{PWM}}}$$

N = number of strings in operation

f_{PWM} = LED PWM dimming frequency

Phase-shift mode is disabled during soft-start, this allows the output to ramp up to the correct voltage in a controlled fashion.

Phase-shifting reduces the peak input current, decreases EMI and improves the dimming linearity. The figures in the Typical Characteristic Section shows the reduction in the input current with phase shift feature enabled compared to the non-phase shifted mode of operation.

Backlight Fade-in and Fade-out Options

The SC5010 features an option for fade-in and fade-out brightness control, which allows smooth transition from one brightness level to another.

Registers associated with this fading functions are shown in this section.

1. Fade Option (register address 0x09) — sets fade enable options, fade time, fade type.
2. Fade Rate (register address 0x0A) — sets fade step size option.

Fade option register allows user to select fading, choose between linear or logarithmic fading, and to set up the fading time. The default setting is fading enabled with logarithmic mode. The fading time is determined by the LED PWM dimming frequency.

An example for calculating the fading time is shown in this section

Assuming LED PWM dimming frequency is 10kHz, then the PWM dimming period is 100 μ s. Fade setting is shown in the following table.

Duty Cycle Range	Step Increment	Step Interval
0 to 511	1	2
512 to 767	1	1
768 to 1024	2	1

10 bits are assigned for 1024 duty cycle settings.

Time required to go from 10% (102/1024) to 90% (922/1024) duty cycle can be calculated using the following equation.

$T_{\text{PWM}} = 100 \mu\text{s}$ (PWM Dimming Period)

Total Cycle = $2 \times (511 - 102) + 256 + \frac{1}{2} \times (922 - 768) = 1151$

Total Time = $1151 \times T_{\text{PWM}} = 115.1 \text{ms}$

Optional Synchronization to SYNC Input

The SC5010 provides an option to synchronize the LED dimming to an external clock source connected to the SYNC pin. In certain applications, it may be beneficial to synchronize the LED drive signal to the LCD screen refresh signals such as VSYNC or HSYNC. This helps reduce or eliminate some of the problems associated with using LED backlights, such as flickering, shimmering, etc.

The phase lock loop available on the SC5010 can be programmed via I²C to synchronize the internal 10MHz oscil-

Applications Information (continued)

lator to the SYNC input. Figures on page 11 show synchronization of SC5010 to a 48kHz HSYNC signal applied on SYNC pin. The turn-on of the LED string IO1 (falling edge of V_{IO1}) is synchronized to the rising edge of the HSYNC input. The turn-on of rest of the strings will be delayed based on the phase shifting algorithm. Another

figure shows the delay (~500ns) between HSYNC rising edge and turn-on of the LED string 1 (IO1).

Input Disconnect

The SC5010 incorporates a high voltage (up to 27V) p-MOSFET gate driver which can be used for controlling an

Table 2 — Fault Protection Descriptions

Type of Fault	User Disable?	Fault Criteria	Action on Fault		Recovery	
			Device	FLT pin (latching / non-latching)	Condition(s)	FLT pin
Input Under-voltage at VIN (UVLO)	No	$V_{IN} < 1 + R_2/R_1 \times 1.23$ (rising)	No Startup	Not Active	$V_{UVLO} > 1.23V$ (rising)	High
	No	$V_{IN} < (1 + R_2/R_1) \times 1.23V - I_{UVLO} \times R_1$ (falling)	Shutdown	Not active	$V_{UVLO} > 1.23V$ (rising)	High
Input Under-voltage at VCC (UVLO)	No	$VCC < 4.2V$ (rising)	No Startup	Not active	$VCC > 4.2V$ (rising)	High
	No	$VCC < 4.0V$ (falling)	Shutdown	Not active	$VCC > 4.2V$ (rising)	High
Over-voltage Protection (OVP)	No	$V_{OVP} > 1.2V$ (rising)	Regulate to OVP threshold: $I_{O(n)} = \text{"on"}$	Low (non-latching)	$V_{OVP} > 1.2V$ (falling)	High on removal of fault condition
Over-current Protection (OCP)	No	$V_{CS} > 0.4V$	Limit Q1 FET drain current $< 0.4V/R3$ (typ)	High	$V_{CS} > 0.4V$	High
Shorted LED(s)	Yes, tie SCP to VCC	$V_{IO(n)} > 20 \times V_{SCP}$	Device on: $I_{O(n)} = \text{"off"}$ Other $I_{O(All)} = \text{"on"}$	Low (latching)	Replace shorted LED(s) and Toggle EN, VCC or UVLO	High
		$V_{IO(All)} > 20 \times V_{SCP}$	Device latch-off; $I_{O(All)} = \text{"off"}$	Low (latching)	Replace shorted LED(s) and Toggle EN, VCC or UVLO	High
Open LED(s)	No	$V_{IO(n)} < 0.1V$ and OVP event	Device on: $I_{O(n)} = \text{"off"}$ Other $I_{O(All)} = \text{"on"}$	Low (latching)	Replace open LED(s) and Toggle EN, VCC or UVLO	High
		$V_{IO(All)} < 0.1V$ and OVP event	Device latch-off; $I_{O(All)} = \text{"off"}$	Low (latching)	Replace open LED(s) and Toggle EN, VCC or UVLO	High
Over-Temperature Protection (OTP)	No	$TJ > 150^\circ C$ (typ)	Device off; $I_{O(All)} = \text{"off"}$	Low (latching)	Satisfy $T_{HYS} > 10^\circ C$; Device on; $I_{O(All)} = \text{"on"}$; Toggle EN, VCC or UVLO	High

Note: Refer to the application circuit example on page 21.

Applications Information (continued)

external p-channel MOSFET. The external p-channel MOSFET provides load disconnection during shutdown or fault mode. It also provides input inrush current limiting during start-up. During shutdown, the DRVP pin is pulled up to VIN voltage via an internal 1MΩ resistor. At startup, the boost converter is held off and the DRVP pin is pulled low via an internal 20μA (typ) current source. When the DRVP pin is pulled lower than the threshold voltage of the external p-channel MOSFET, the input current starts charging up the output capacitor to the input voltage. After that, the boost converter enters into soft start mode.

Fault Protection

SC5010 provides fault detection for low supply voltage, LED related faults, missing V_{SYNC} input, boost converter over-voltage and thermal shutdown. The open drain output pin (FLT) indicates a system fault. The nature of the fault can be read from the fault status resistor (register address: 0x00) via I²C interface. Refer to Table 2 for a description of the Fault Protection Modes.

Other Possible Configurations

Depending on different application requirement, the SC5010 can also be easily configured to other topology such as SEPIC (Single-Ended Primary-Inductor Converter) configuration as shown in Figure 3.

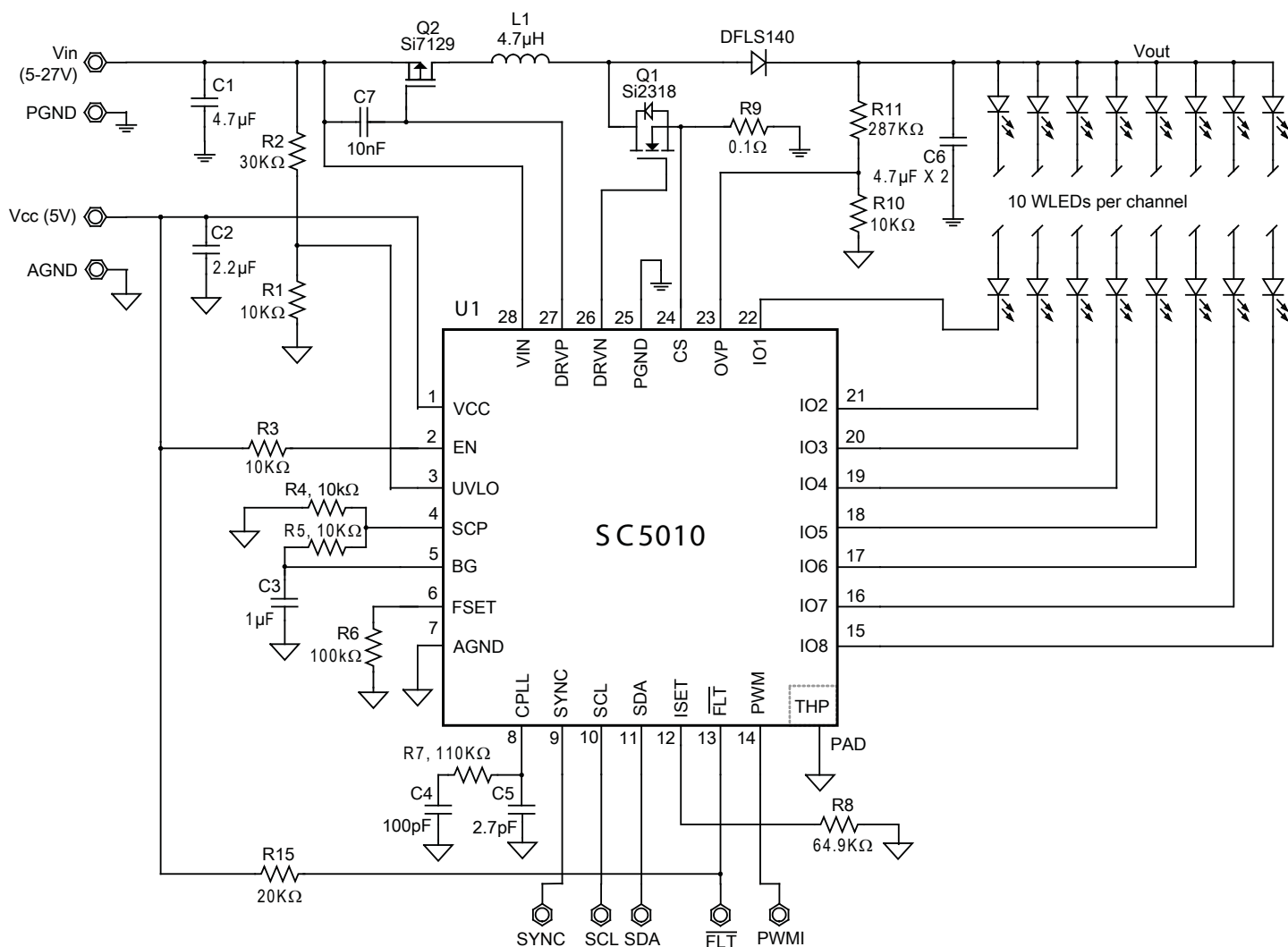

Figure 2 — Detailed Application Circuit

Applications Information (continued)

High Output Voltage Configuration

If high output voltage application is required, an additional external cascode MOSFET can be added on each IO pin to meet such requirement, please refer to figure 4 for reference.

In this case, the upper limit on the output voltage is mainly determined by the rating of the external MOSFET, heat dissipation, etc.

PCB Layout Considerations

The placements of the power components outside the SC5010 should follow the layout guidelines of a general boost converter. The Detailed Application Circuit is used as an example.

1. Capacitor (C2) should be placed as close as possible to the VCC and AGND to achieve the best performance.
2. Capacitor (C1) is the input power filtering capacitor for the boost, it needs to be tied to PGND.
3. The converter power train inductor (L1) is the boost converter input inductor. Use wide and short traces connecting these components.
4. The output rectifying diode (D1) uses a Schottky diode for fast reverse recovery. Transistor (Q1) is the external switch. Resistor (R9) is the switch current sensing resistor. To minimize switching noise for the boost converter, the output capacitor (C6) should be placed such that the loop formed by Q1, D1, C6 and R9, is minimized. The output of the boost converter is used to power up the LEDs. Use wide and short trace connecting Pin DRVN and the gate of Q1. The GNDs

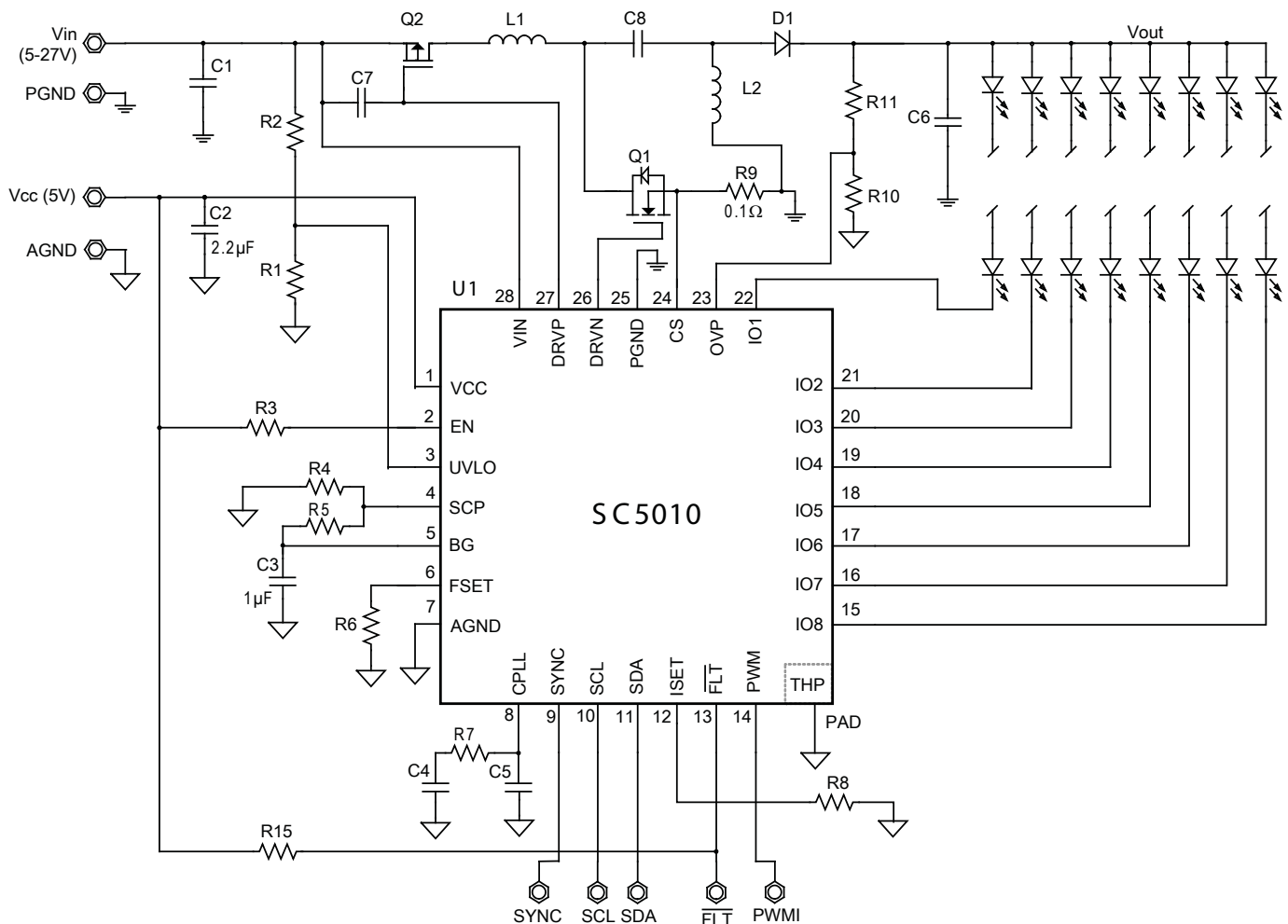

Figure 3 — SEPIC Configuration

Components Selection

Inductor Selection

The choice of the inductor affects the converter's steady state operation, transient response, and its loop stability. Special attention needs to be paid to three specifications of the inductor, its value, its DC resistance and saturation current. The inductor's inductance value also determines the inductor ripple current. The boost converter will operate in either CCM (Continuous Conduction Mode) or DCM (Discontinuous Conduction Mode) depending on its operating conditions. The inductor DC current or input current can be calculated using the following equation.

$$I_{IN} = \frac{V_{OUT} \times I_{OUT}}{V_{IN} \times \eta}$$

I_{IN} — Input current; I_{OUT} — Output current;

V_{OUT} — Boost output voltage;

V_{IN} — Input voltage;

η — Efficiency of the boost converter.

Then the duty ratio under CCM is shown by the following equation.

$$D = \frac{V_{OUT} - V_{IN} + V_D}{V_{OUT} + V_D}$$

V_D – Forward conduction drop of output rectifying diode

When the boost converter runs under DCM ($L < L_{boundary}$), it takes the advantages of small inductance and quick transient response; where as if the boost converter works under CCM ($L > L_{boundary}$), normally the converter has higher efficiency.

When selecting an inductor, another factor to consider is the peak-to-peak inductor current ripple, which is given by the following equation.

$$\Delta I_L = \frac{V_{IN} \times D}{f_{SW} \times L}$$

Usually this peak-to-peak inductor current ripple can be chosen between 30% to 50% of the maximum input DC current. This gives the best compromise between the inductor size and converter efficiency. The peak inductor current can be calculated using the following equation.

$$I_{L-peak} = I_{IN} + \frac{V_{IN} \times D}{2 \times f_{SW} \times L}$$

For most applications, an inductor with value of 2.2 μ H to 22 μ H should be acceptable, (refer to the Typical Application Circuit on page 21). The inductor peak current must be less than its saturation rating. When the inductor current is close to the saturation level, its inductance can decrease 20% to 35% from the 0A value depending on the vendor specifications. Using a small value inductor forces the converter in DCM, in which case the inductor current ramps down to zero before the end of each switching cycle. It reduces the boost converter's maximum output current and produces larger input voltage ripple. The DCR of the inductor plays a significant role for the total system efficiency and usually there is a trade-off between the DCR and size of the inductor. Table 3 lists some recommended inductors and their vendors.

Table 3 — Recommended Inductors

Inductor	Web site
XFL4020, 2.2 μ H ~ 4.7 μ H	www.coilcraft.com
DR73, 4.7 μ H ~ 22 μ H; DR74, 4.7 μ H ~ 22 μ H	www.cooperet.com
IHLP-2525CZ-01, 4.7 μ H ~ 10 μ H	www.vishay.com
DS84LC, 4.7 μ H ~ 10 μ H; D62LCB, 4.7 μ H ~ 22 μ H	www.toko.co.jp

Output Capacitor Selection

The next design task is targeting the proper amount of output ripple voltage due to the constant-current LED loads. Usually X5R or X7R ceramic capacitor is recommended. The ceramic capacitor minimum capacitance needed for a given ripple can be estimated using the following equation.

$$C_{OUT} = \frac{(V_{OUT} - V_{IN}) \times I_{OUT}}{V_{OUT} \times f_{SW} \times V_{RIPPLE}}$$

V_{RIPPLE} – Peak to peak output ripple.

The ripple voltage should be less than 200mV (pk-pk) to ensure good LED current sink regulation. For example, a typical application where 20mA/channel current is needed, the total output current for 8 channels will be

Components Selection (continued)

160mA, and 1x 10 μ F or 2x 4.7 μ F capacitors are recommended.

During load transient, the output capacitor supplies or absorbs additional current before the inductor current reaches its steady state value. Larger capacitance helps with the overshoot/undershoots during load transient and loop stability. Recommended ceramic capacitor manufacturers are listed in Table 4.

Table 4 — Recommended Ceramic Capacitor Vendors

Vendor	Web site
Kemet	www.kemet.com
Vishay	www.vishay.com
TDK	www.tdk.com
Murata	www.murata.com
Taiyo Yuden	www.t-yuden.com

Input Capacitor Selection

X5R or X7R ceramic capacitor is recommended for input bypass capacitor. A 1 μ F capacitor is sufficient for the VCC input. Bypass the VIN input with a 4.7 μ F or larger ceramic capacitor.

Output Freewheeling Diode Selection

Schottky diodes are the ideal choice for SC5010 due to their low forward voltage drop and fast switching speed. Table 5 shows several different Schottky diodes that work properly with the SC5010. Verify that the diode has a voltage rating greater than the maximum possible output voltage. The diode conducts current only when the power switch is turned off. The diode must be rated to handle the average output current. A diode rated for 1A average current will be sufficient for most designs.

Table 5 — Recommended Rectifier Diodes

Rectifier Diode	Vendor Web site
DFLS140	www.diodes.com
1N5819HW	www.diodes.com
SS13/14/15/16, SS23/24/25/26	www.vishay.com

External Power MOSFET Selection

The boost converter in SC5010 uses an external power MOSFET to regulate the output voltage and output power

to drive LED loads. This boost switching structure has an advantage in that the SC5010 is not exposed to high voltage. Only the external power MOSFET, freewheeling diode and the inductor will be exposed to the output voltage. The external power MOSFET should be selected with its voltage rating higher than the output voltage by minimum 30%. The current rating should be enough to handle the inductor peak current. Low $R_{DS(on)}$ MOSFETs are preferred for achieving better efficiency.

The GD (gate driver) on SC5010 provides 1A (peak) current driving capability which is suitable for most MOSFETs for high frequency operation. The average current required to drive the MOSFET is given by the following equation.

$$I_{GATE} = Q_G \times f_{SW}$$

Q_G — Gate charge

The $R_{DS(ON)}$ and its RMS current $I_{S,RMS}$ of the power MOSFET will generate the conduction loss using the following equation.

$$P_{COND} = I_{S,RMS}^2 \times R_{DS(on)}$$

The MOSFET's switch loss can be calculated using the following equation.

$$P_{SW} = \frac{1}{2} \times V_{IN} \times I_{L,PEAK} \times f_{SW} \times (T_{ON} + T_{OFF})$$

Where T_{ON} and T_{OFF} are the MOSFET's on and off time and they can be estimated by the following equations.

$$T_{ON} = t_r + \frac{Q_{gd}}{(5 - V_{plateau}) / (5 + R_g)}$$

$$T_{OFF} = t_f + \frac{Q_{gd}}{V_{plateau} / (5 + R_g)}$$

Where t_r , t_f , Q_{gd} and $V_{plateau}$ can usually be found from data-sheet of the selected MOSFET. R_g is the resistance of the optional resistor connected in series on the gate of the MOSFET.

Components Selection (continued)

Current Sensing Resistor Selection

The switch current is sensed via the current sensing resistor, R_{SNS} . The sensed voltage at this pin is used to set the peak switch current limit and also used for steady state regulation of the inductor current. The current limit comparator has a trip voltage of 0.4V. R_{SNS} value is chosen to set the peak inductor and switch current using the following equation.

$$I_{SW(Peak)} = 0.4/R_{SNS}$$

The power dissipation in R_{SNS} can be calculated using the following equations.

$$P_{R_{SNS}} = I_{RMS}^2 \times R_{SNS}$$

$$I_{RMS} = D \times [I_O/(1-D)]^2$$

$$I_O = \text{Output DC Current, } D = \text{Duty Cycle}$$

For the typical application circuit shown in the Detailed Application Circuit (page 21), the power dissipation on the sensing resistor is shown by the following equations.

Assuming $V_{IN}(\text{Min}) = 5V$ and $V_{OUT} = 30V$, thus $D = 84\%$,

$$P_{R_{SNS}} = [(0.12/0.16)^2 \times 0.1] \times 0.84 = 0.047(W)$$

For this example, a 0.1 Ω 1% thick-film chip resistor rated at 0.125W can be used.

PLL Filter Component Selection

The Detailed Application Circuit on page 21 shows the optimal R/C filter components for the PLL compensation. These are optimized for internal 1MHz switching frequency. Please contact Semtech application group if a different switching frequency is selected.

Isolation MOSFET Selection

The external p-channel MOSFET provides load disconnection during shutdown or fault condition. Select a MOSFET with low $R_{DS(on)}$ to limit the power loss.

In order to implement inrush current limiting, a 10nF capacitor is connected between the gate and source terminal of the MOSFET.

If isolation is not required, then the DRVP pin can be left floating. Connect the VIN directly to the inductor.

Serial Interface

The I²C General Specification

The SC5010 is a read-write slave-mode I²C device and complies with the Philips I²C standard Version 2.1, dated January 2000. The SC5010 has 11 user-accessible internal 8-bit registers. The I²C interface has been designed for program flexibility, supporting direct format for write operation. Read operations are supported on both combined format and stop separated format. While there is no auto increment/decrement capability in the SC5010 I²C logic, a tight software loop can be designed to randomly access the next register independent of which register you begin accessing. The start and stop commands frame the data-packet and the repeat start condition is allowed if necessary.

Limitations to the I²C Specifications

The SC5010 only recognizes seven bit addressing. This means that ten bit addressing and CBUS communication are not compatible. The device can operate in either standard mode (100kbit/s) or fast mode (400kbit/s).

Slave Address Assignment

The seven bit slave address is 0101 111x. The eighth bit is the data direction bit. 0x5F is used for a write operation, and 0x5E is used for a read operation.

Supported Formats

The supported formats are described in the following subsections.

(1) Direct Format — Write

The simplest format for an I²C write is direct format. After the start condition [S], the slave address is sent, followed by an eighth bit indicating a write. The SC5010 I²C then acknowledges that it is being addressed, and the master responds with an 8 bit data byte consisting of the register address. The slave acknowledges and the master sends the appropriate 8 bit data byte. Once again, the slave acknowledges and the master terminates the transfer with the stop condition [P].

(2) Combined Format — Read

After the start condition [S], the slave address is sent, followed by an eighth bit indicating a write. The SC5010 I²C then acknowledges that it is being addressed, and the

master responds with an 8 bit data byte consisting of the register address. The slave acknowledges and the master sends the repeated start condition [Sr]. Once again, the slave address is sent, followed by an eighth bit indicating a read. The slave responds with an acknowledge and the 8 bit data from the previously addressed register; the master then sends a non-acknowledge (NACK). Finally, the master terminates the transfer with the stop condition [P].

(3) Stop Separated Reads

Stop-separated reads can also be used. This format allows a master to set up the register address pointer for a read and return to that slave at a later time to read the data. In this format the slave address followed by a write command are sent after a start [S] condition. The SC5010 then acknowledges it is being addressed, and the master responds with the 8-bit register address. The master sends a stop or restart condition and may then address another slave. After performing other tasks, the master can send a start or restart condition to the SC5010 with a read command. The device acknowledges this request and returns the data from the register location that had previously been set up.



I²C Direct Format Write

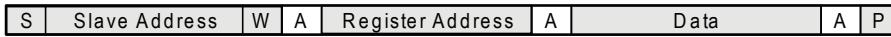

S – Start Condition
 W – Write = '0'
 A – Acknowledge (sent by slave)
 P – Stop condition

Slave Address – 7-bit
 Register address – 8-bit
 Data – 8-bit

I²C Stop Separated Format Read

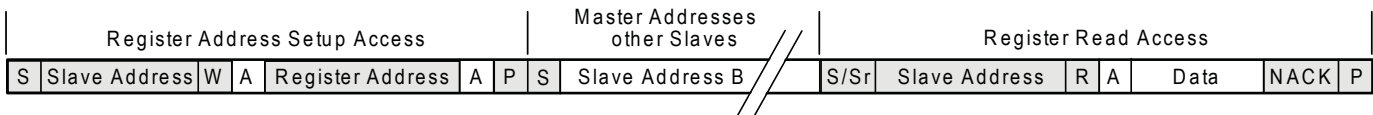

S – Start Condition
 W – Write = '0'
 R – Read = '1'
 A – Acknowledge (sent by slave)
 NAK – Non-Acknowledge (sent by master)
 Sr – Repeated Start condition
 P – Stop condition

Slave Address – 7-bit
 Register address – 8-bit
 Data – 8-bit

I²C Combined Format Read



S – Start Condition
 W – Write = '0'
 R – Read = '1'
 A – Acknowledge (sent by slave)
 NAK – Non-Acknowledge (sent by master)
 Sr – Repeated Start condition
 P – Stop condition

Slave Address – 7-bit
 Register address – 8-bit
 Data – 8-bit

Register Map

Address	Name	Reset Value	Bit 7	Bit 6	Bit 5	Bit 4	Bit 3	Bit 2	Bit 1	Bit 0
0x00	Fault Status	0x00	CLF	-	LED_SHORT	LED_OPEN	SYNC_GD	OTP	OVP	FAULT
0x01	Device Control	0xB5	WND1	WND0	FAST_FREQ	FLT_EN	SYNC_EN	PHASE_SHIFT	INT_DUTY	INT_PWM
0x02	Analog Dimming Control	0x1F	-	-	-	IDAC4	IDAC3	IDAC2	IDAC1	IDAC0
0x03	Dimming Duty Cycle Control 1	0x00	-	-	-	-	-	-	D9	D8
0x04	Dimming Duty Cycle Control 2	0x00	D7	D6	D5	D4	D3	D2	D1	D0
0x05	Dimming Frequency Select	0x00	FREQ7	FREQ6	FREQ5	FREQ4	FREQ3	FREQ2	FREQ1	FREQ0
0x06	PLL Divider MSB	0x00	-	-	-	-	-	-	NPLL17	NPLL16
0x07	PLL Divider LSB2	0x00	NPLL15	NPLL14	NPLL13	NPLL12	NPLL11	NPLL10	NPLL9	NPLL8
0x08	PLL Divider LSB1	0x08	NPLL7	NPLL6	NPLL5	NPLL4	NPLL3	NPLL2	NPLL1	NPLL0
0x09	Fade Options	0x80	FADE_EN	FADE_TYPE	-	-	-	STEP_MUL2	STEP_MUL1	STEP_MUL0
0x0A	Fade Rate	0x00	-	FADE_RATE6	FADE_RATE5	FADE_RATE4	FADE_RATE3	FADE_RATE2	FADE_RATE1	FADE_RATE0

Definition of Registers and Bits

Fault Status Register

This register monitors various fault conditions.

Bit Field	Definition	Read / Write	Description
0x00 [7]	CLF	W	Clear latching flags bit. (Set = 1 to clear OTP, LED_OPEN, LED_SHORT and mask OVP for 32 to 64 μ s)
0x00 [5]	LED_SHORT	R	LED string short circuit fault status 1 = One or more LED strings short-circuit detected 0 = no LED string short-circuit detected
0x00 [4]	LED_OPEN	R	LED string open circuit fault status 1 = One or more LED strings open-circuit detected 0 = no LED string open-circuit detected
0x00 [3]	SYNC_GD	R	SYNC good signal indication 1 = SYNC input is detected 0 = no SYNC signal detected
0x00 [2]	OTP	R	Thermal shutdown status 1 = OTP (Over-Temperature Protection) fault detected 0 = no OTP (Over-Temperature Protection) fault detected
0x00 [1]	OVP	R	Output Over-Voltage (OVP) fault 1 = Output OVP fault detected 0 = no output OVP fault detected
0x00 [0]	FAULT	R	OR of all fault conditions 1 = any one, or some, or all of the fault conditions detected 0 = no fault detected

Definition of Registers and Bits (continued)

Device Control Register

This register provides different control features of the device.

Bit Field	Definition	Read / Write	Description
0x01 [7:6]	WIN[1:0]	R/W	A modified duty cycle sent into the PWMI pin replaces the existing saved duty cycle when its deviation from the saved duty is outside the window for two consecutive samples. 00 = 0 bits (no window) 01 = ±1 bit window 10 = ±2 bit window 11 = ±3 bit window
0x01 [5]	FAST_FREQ	R/W	Determines the LED PWM dimming frequency selection: 0 = Low PWM dimming frequency mode assuming 10-bit PWM duty cycle dimming, dividing the system clock 10MHz / (1024 x (FREQ+1)). 1 = High PWM dimming frequency mode assuming 9-bit PWM duty cycle dimming, dividing the system clock 10MHz / (512 x (FREQ+1)).
0x01 [4]	FLT_EN	R/W	This bit enables fault checking: 0 = LED_OPEN and LED_SHORT faults are not checked. 1 = LED_OPEN and LED_SHORT faults are checked.
0x01 [3]	SYNC_EN	R/W	Enables video signal synchronization with the PLL: 0 = SYNC is disabled. 1 = PLL tracks the SYNC input signal.
0x01 [2]	PH_SHIFT	R/W	Enables String-by-String phase shifting. This is a don't care if INT_PWM=0. 0 = Phase shifting disabled. 1 = Phase shifting is enabled
0x01 [1]	INT_DUTY	R/W	Determines the duty cycle source. This is a don't care if INT_PWM = 0. 0 = LED duty cycle is set by the PWMI input 1 = LED duty cycle is set by the 10-bit duty cycle control registers
0x01 [0]	INT_PWM	R/W	Sets the LED PWM dimming source. 0 = LED PWM dimming driven directly from the PWMI input source (direct PWM dimming) 1 = LED PWM dimming driven from an internal oscillator (required for phase-shifted PWM dimming); enables the PLL.

Definition of Registers and Bits (continued)

Analog Dimming Control Register

This register is used to program the LED string current through the on-chip 5-bit DAC.

Bit Field	Definition	Read / Write	Description
0x02 [4:0]	IDAC [4:0]	R / W	5-bit analog dimming register — The LED string current can be evenly adjusted in 32 steps from 0mA to the maximum value determined by R_{ISET} . For example, if the maximum LED string current set by R_{ISET} is 20mA/string, when IDAC[4:0] is set to be 0b00101, the LED string current will be $20mA \times 5/(2^5-1) = 3.2mA/string$.

Dimming Duty Cycle Control Register

These two registers (0x03 and 0x04) combine together as a 10-bit register for controlling the PWM dimming duty cycle.

Bit Field	Definition	Read / Write	Description
0x03 [1:0] 0x04 [7:0]	D [9:0]	R / W	10-bit PWM brightness setting — This value is spread over registers: 0x03 (MSB) and 0x04 (LSB). The LED PWM dimming duty cycle can be evenly adjusted by the 10-bit register from 0 to 100% with D[9:0] value changes from 0 to 0x3F.

Dimming Frequency Select Register

This register is used to program the LED PWM dimming frequency.

Bit Field	Definition	Read / Write	Description
0x05 [7:0]	FREQ [7:0]	R / W	This register sets the LED dimming frequency. FAST_FREQ = 1, then LED dimming frequency is equal to $10MHz / (512 \times (FREQ+1))$ FAST_FREQ = 0, then LED dimming frequency is equal to $10MHz / (1024 \times (FREQ+1))$

PLL Control Registers

This register is used to set the PLL divider value.

Bit Field	Definition	Read / Write	Description
0x06 [1:0] 0x07 [7:0] 0x08 [7:0]	NPLL [17:0]	R / W	These registers set the PLL divider value — The system clock is intended to run at 10MHz; this value divides the system clock down to a frequency comparable to the SYNC signal's frequency to allow PLL synchronization. Typical values are shown below.

F_{IN}	PLL Divider N	Register Values	$F_{PLL} = (N+2) \times F_{IN}$
60 Hz	169,982	0x02 - 0x97 - 0xFE	10MHz
1 MHz	8	0x00 - 0x00 - 0x08	10MHz

Definition of Registers and Bits (continued)

Fade Options Registers

This register is used to select the fade in and fade out related features.

Bit Field	Definition	Read / Write	Description
0x09 [7]	FADE_EN	R/W	Enables the fading feature. FADE_EN = 0: No Fading; Jumps directly to new PWM value. FADE_EN = 1: Enables fading.
0x09 [6]	FADE_TYPE	R/W	Selects the fading type. FADE_TYPE = 0: Logarithmic Fading FADE_TYPE = 1: Linear Fading
0x09 [2:0]	STEP_MUL [2:0]	R/W	Used to speed up fade time, when selected LED PWM dimming frequency is low. Define a 2^N multiplier of the fade amount. STEP_MUL[2:0] = 000, N=0, multiplier = 1 STEP_MUL[2:0] = 001, N=1, multiplier = $2^1 = 2$ STEP_MUL[2:0] = 010, N=2, multiplier = $2^2 = 4$ STEP_MUL[2:0] = 011, N=3, multiplier = $2^3 = 8$ STEP_MUL[2:0] = 100, N=4, multiplier = $2^4 = 16$ STEP_MUL[2:0] = 101~111, N=5, multiplier = $2^5 = 32$

Fade Rate Register

This register is used to program the rate of the duty cycle change during the fade in and fade out operation.

Bit Field	Definition	Read / Write	Description
0x0A [6:0]	FADE_RATE [6:0]	R / W	Defines how often the duty is changed during a fade. Fade rate = PWM Output Rate / (1 + FADE_RATE[6:0])

Outline Drawing — MLPQ-UT-28 4x4

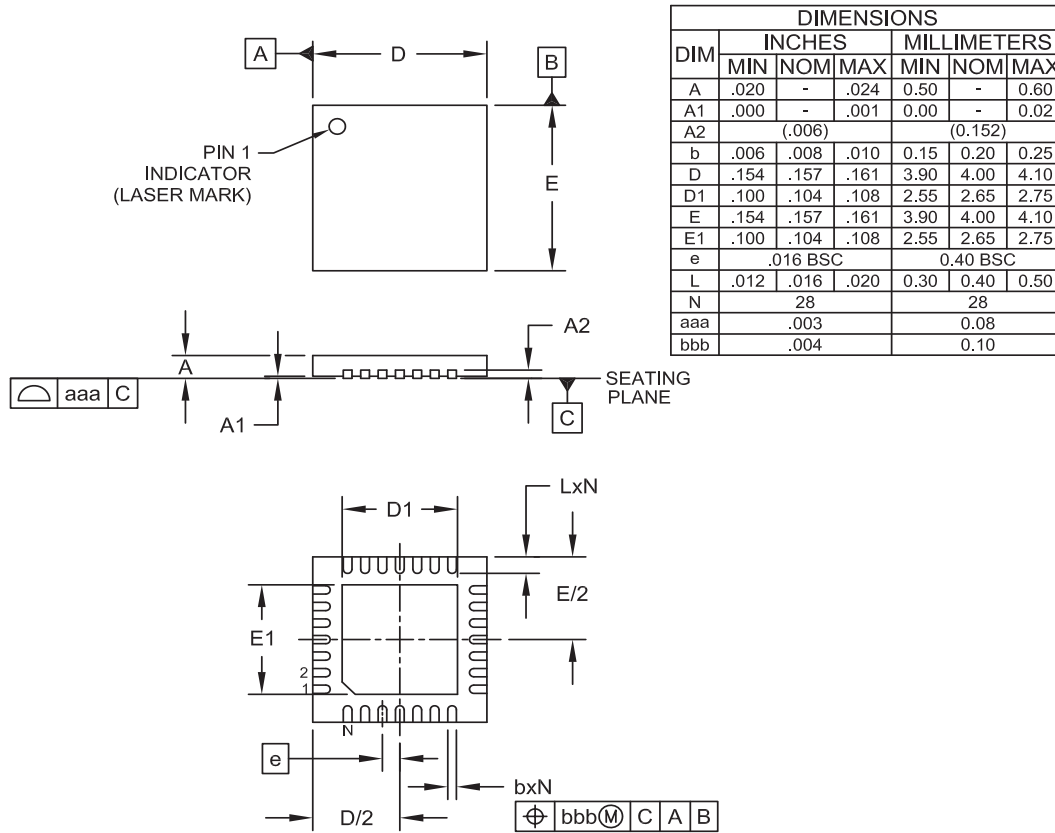

NOTES:

1. CONTROLLING DIMENSIONS ARE IN MILLIMETERS (ANGLES IN DEGREES).
2. COPLANARITY APPLIES TO THE EXPOSED PAD AS WELL AS THE TERMINALS.

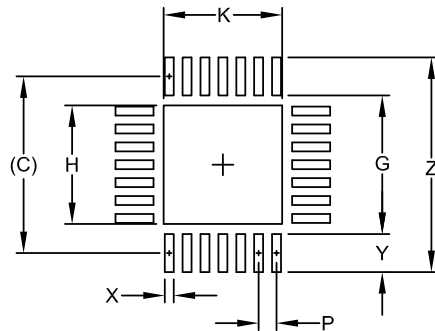
Land Pattern — MLPQ-UT-28 4x4

DIMENSIONS		
DIM	INCHES	MILLIMETERS
C	(.156)	(3.95)
G	.122	3.10
H	.104	2.65
K	.104	2.65
P	.016	0.40
X	.008	0.20
Y	.033	0.85
Z	.189	4.80

NOTES:

1. CONTROLLING DIMENSIONS ARE IN MILLIMETERS (ANGLES IN DEGREES).
2. THIS LAND PATTERN IS FOR REFERENCE PURPOSES ONLY. CONSULT YOUR MANUFACTURING GROUP TO ENSURE YOUR COMPANY'S MANUFACTURING GUIDELINES ARE MET.
3. THERMAL VIAS IN THE LAND PATTERN OF THE EXPOSED PAD SHALL BE CONNECTED TO A SYSTEM GROUND PLANE. FAILURE TO DO SO MAY COMPROMISE THE THERMAL AND/OR FUNCTIONAL PERFORMANCE OF THE DEVICE.
4. SQUARE PACKAGE-DIMENSIONS APPLY IN BOTH X AND Y DIRECTIONS.



© Semtech 2011

All rights reserved. Reproduction in whole or in part is prohibited without the prior written consent of the copyright owner. The information presented in this document does not form part of any quotation or contract, is believed to be accurate and reliable and may be changed without notice. No liability will be accepted by the publisher for any consequence of its use. Publication thereof does not convey nor imply any license under patent or other industrial or intellectual property rights. Semtech assumes no responsibility or liability whatsoever for any failure or unexpected operation resulting from misuse, neglect improper installation, repair or improper handling or unusual physical or electrical stress including, but not limited to, exposure to parameters beyond the specified maximum ratings or operation outside the specified range.

SEMTECH PRODUCTS ARE NOT DESIGNED, INTENDED, AUTHORIZED OR WARRANTED TO BE SUITABLE FOR USE IN LIFE-SUPPORT APPLICATIONS, DEVICES OR SYSTEMS OR OTHER CRITICAL APPLICATIONS. INCLUSION OF SEMTECH PRODUCTS IN SUCH APPLICATIONS IS UNDERSTOOD TO BE UNDERTAKEN SOLELY AT THE CUSTOMER'S OWN RISK. Should a customer purchase or use Semtech products for any such unauthorized application, the customer shall indemnify and hold Semtech and its officers, employees, subsidiaries, affiliates, and distributors harmless against all claims, costs damages and attorney fees which could arise.

Notice: All referenced brands, product names, service names and trademarks are the property of their respective owners.

Contact Information

Semtech Corporation
Power Management Products Division
200 Flynn Road, Camarillo, CA 93012
Phone: (805) 498-2111 Fax: (805) 498-3804

www.semtech.com