

## Silicon NPN Power Transistors

2SC4908

## DESCRIPTION

- With TO-220F package
- High voltage.
- High speed switching

## APPLICATIONS

- For switching regulator and general purpose applications

## PINNING

PIN	DESCRIPTION
1	Base
2	Collector
3	Emitter

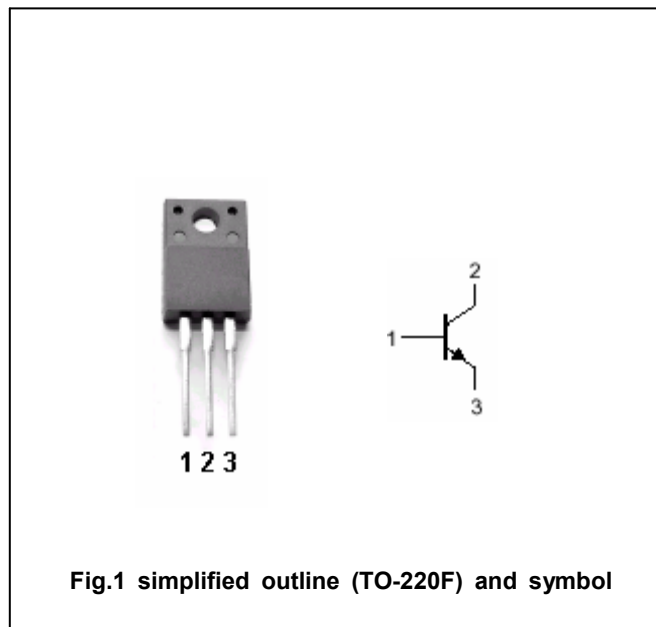

## Absolute maximum ratings (Ta=25°C)

SYMBOL	PARAMETER	CONDITIONS	VALUE	UNIT
V <sub>CBO</sub>	Collector-base voltage	Open emitter	900	V
V <sub>CEO</sub>	Collector-emitter voltage	Open base	800	V
V <sub>EBO</sub>	Emitter-base voltage	Open collector	7	V
I <sub>C</sub>	Collector current		3	A
I <sub>CM</sub>	Collector current-peak		6	A
I <sub>B</sub>	Base current		1.5	A
P <sub>C</sub>	Collector power dissipation	T <sub>C</sub> =25°C	35	W
T <sub>j</sub>	Junction temperature		150	°C
T <sub>stg</sub>	Storage temperature		-55~150	°C

## Silicon NPN Power Transistors

## 2SC4908

## CHARACTERISTICS

Tj=25°C unless otherwise specified

SYMBOL	PARAMETER	CONDITIONS	MIN	TYP.	MAX	UNIT
$V_{(BR)CEO}$	Collector-emitter breakdown voltage	$I_C=10mA ; I_B=0$	800			V
$V_{CEsat}$	Collector-emitter saturation voltage	$I_C=0.7A ; I_B=0.14A$			0.5	V
$V_{BEsat}$	Base-emitter saturation voltage	$I_C=0.7A ; I_B=0.14A$			1.2	V
$I_{CBO}$	Collector cut-off current	$V_{CB}=800V ; I_E=0$			100	$\mu A$
$I_{EBO}$	Emitter cut-off current	$V_{EB}=7V ; I_C=0$			100	$\mu A$
$h_{FE}$	DC current gain	$I_C=0.7A ; V_{CE}=4V$	10		30	
$C_{OB}$	Output capacitance	$I_E=0 ; V_{CB}=10V ; f=1MHz$		40		pF
$f_T$	Transition frequency	$I_E=-0.3A ; V_{CE}=12V$		6		MHz

## Switching times

$t_{on}$	Turn-on time	$I_C=0.7A ; I_{B1}=0.1A$ $I_{B2}=-0.35A$ $V_{CC}=250V , R_L=357\Omega$			1.0	$\mu s$
$t_s$	Storage time				5.0	$\mu s$
$t_f$	Fall time				1.0	$\mu s$

Silicon NPN Power Transistors

2SC4908

PACKAGE OUTLINE

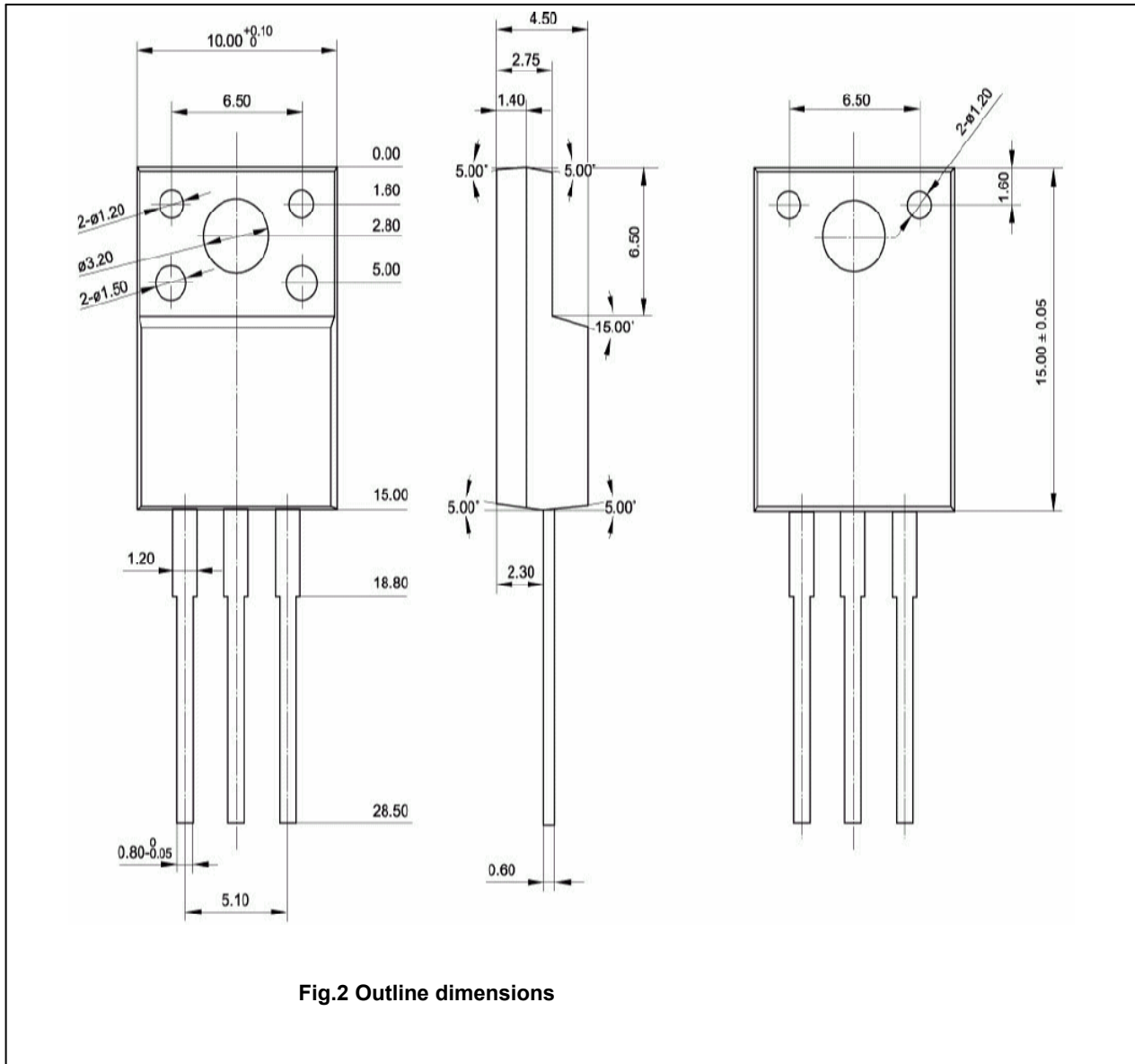

Fig.2 Outline dimensions

Silicon NPN Power Transistors

2SC4908

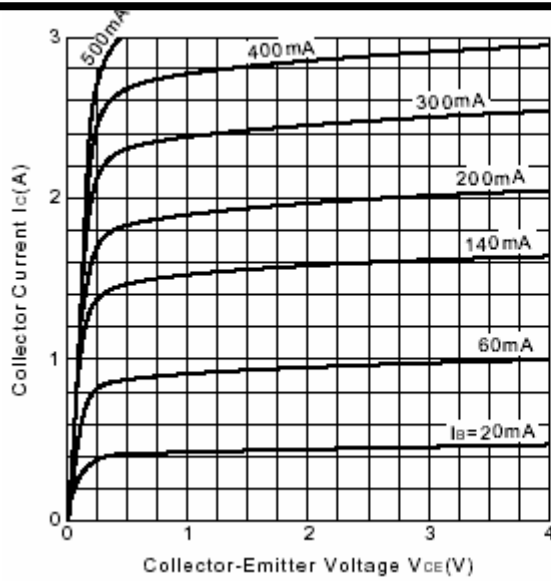

Fig.3 Static Characteristic

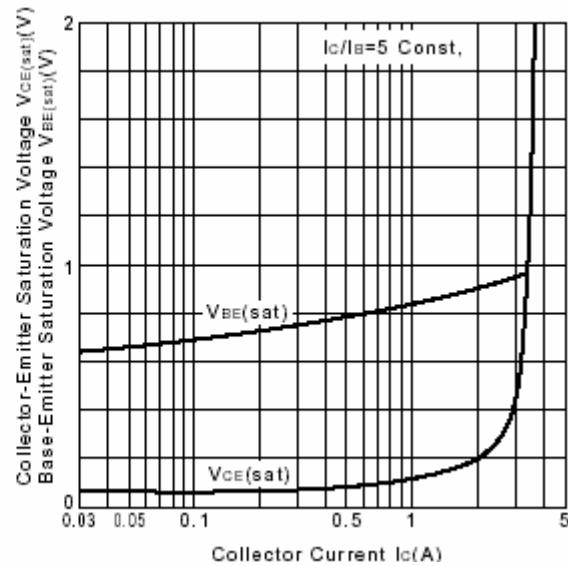

Fig.4 Base-Emitter Saturation Voltage  
Collector-Emitter Saturation Voltage

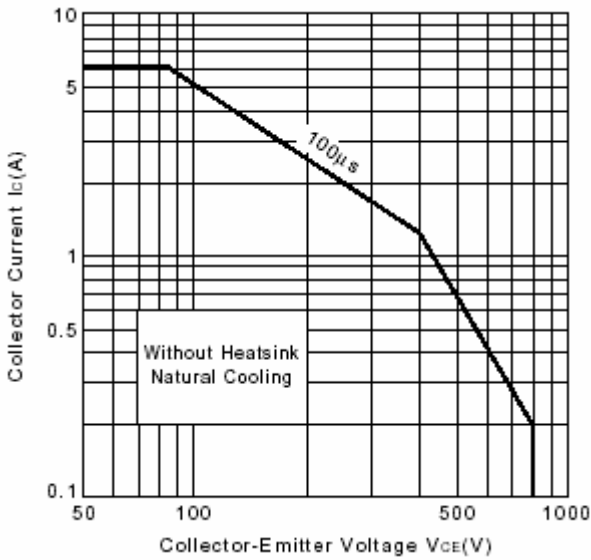

Fig.5 Safe Operating Area

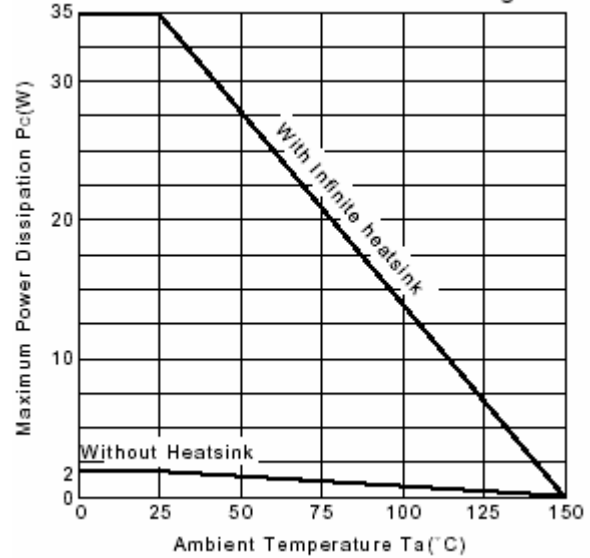

Fig.6  $P_c$ - $T_a$  Derating

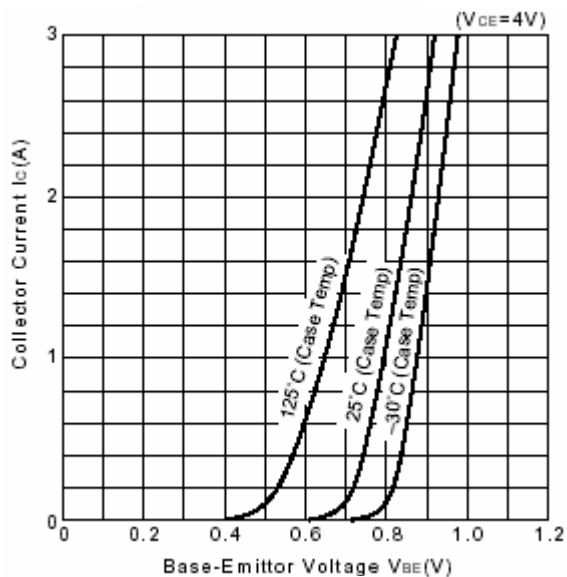

Fig.7  $I_c$ - $V_{BE}$

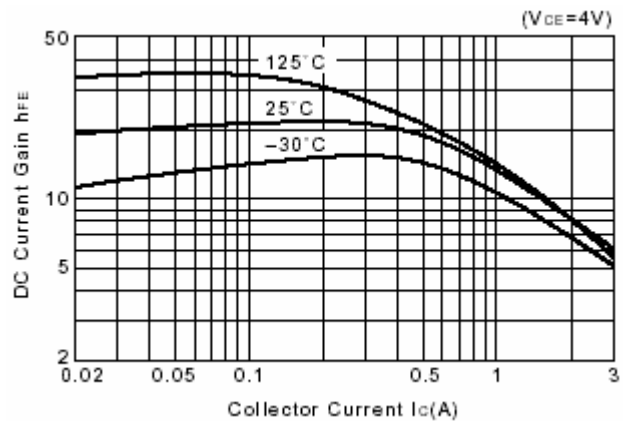

Fig.8 DC current Gain