



Typical Applications

The HMC521LC4 is ideal for:

- Point-to-Point and Point-to-Multi-Point Radio
- Military Radar

Features

- Wide IF Bandwidth: DC - 3.5 GHz
- Image Rejection: 38 dB
- LO to RF Isolation: 50 dB
- High Input IP3: +23 dBm
- RoHS Compliant 4x4 mm SMT Package

Functional Diagram

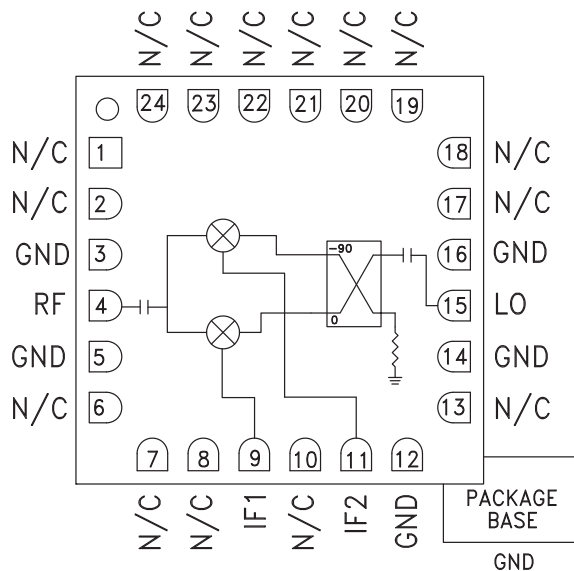

General Description

The HMC521LC4 is a compact I/Q MMIC mixer in a leadless "Pb free" RoHS compliant SMT package, which can be used as either an Image Reject Mixer or a Single Sideband Upconverter. The mixer utilizes two standard Hittite double balanced mixer cells and a 90 degree hybrid fabricated in a GaAs MESFET process. A low frequency quadrature hybrid was used to produce a 100 MHz USB IF output. This product is a much smaller alternative to hybrid style Image Reject Mixers and Single Sideband Upconverter assemblies. The HMC521LC4 eliminates the need for wire bonding allowing use of surface mount manufacturing techniques.

Electrical Specifications, $T_A = +25^\circ C$, $IF = 100 MHz$, $LO = +15 dBm^*$

| Parameter | Min. | Typ. | Max. | Min. | Typ. | Max. | Units |
|--------------------------|------|------------|------|-------------|------|------|-------|
| Frequency Range, RF/LO | | 8.5 - 13.5 | | 10.5 - 11.7 | | | GHz |
| Frequency Range, IF | | DC - 3.5 | | DC - 3.5 | | | GHz |
| Conversion Loss (As IRM) | | 8 | 10 | | 7.5 | 9.5 | dB |
| Image Rejection | 20 | 30 | | 30 | 38 | | dB |
| 1 dB Compression (Input) | | +14 | | | +15 | | dBm |
| LO to RF Isolation | 35 | 45 | | 45 | 55 | | dB |
| LO to IF Isolation | 18 | 22 | | 20 | 24 | | dB |
| IP3 (Input) | | +23 | | | +24 | | dBm |
| Amplitude Balance | | 0.3 | | | 0.1 | | dB |
| Phase Balance | | 4 | | | 4 | | Deg |

* Unless otherwise noted, all measurements performed as downconverter.



Data Taken As IRM With External IF Hybrid

Conversion Gain vs. Temperature

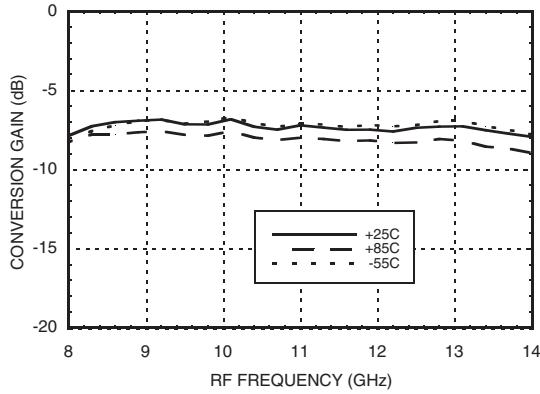
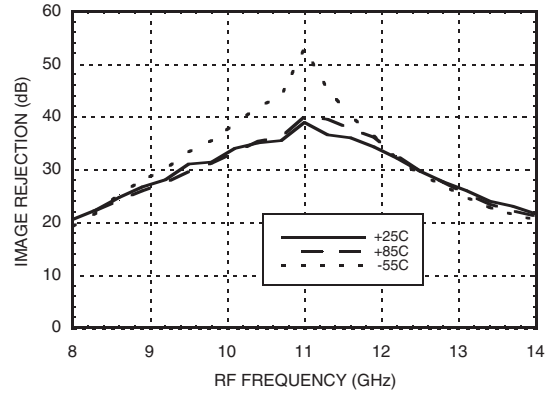
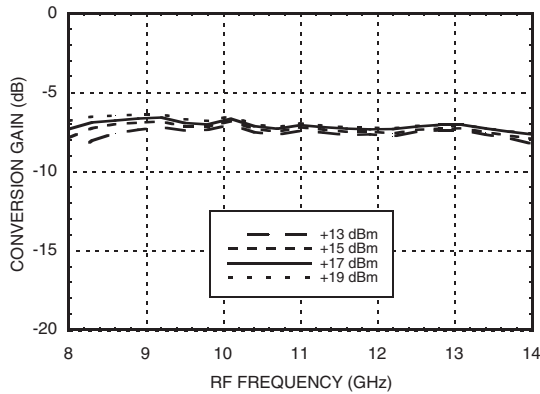

Image Rejection vs. Temperature



Conversion Gain vs. LO Drive



Return Loss

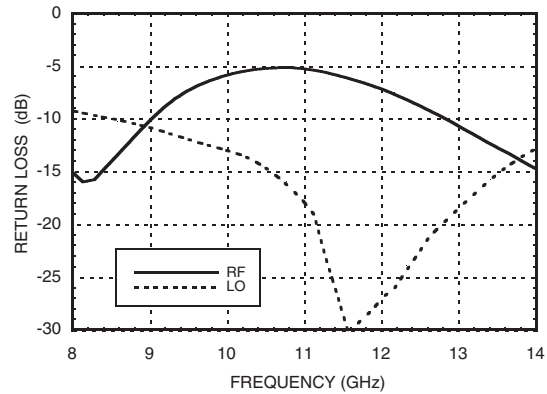

Input P1dB vs. Temperature

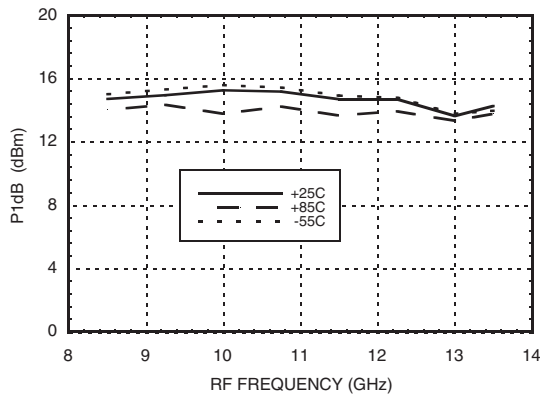

Input IP3 vs. LO Drive

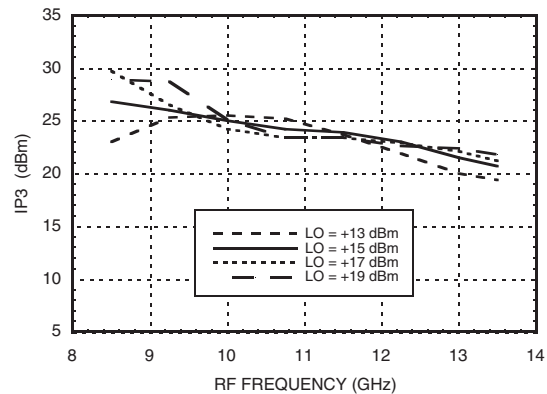



Quadrature Channel Data Taken Without IF Hybrid

Isolations

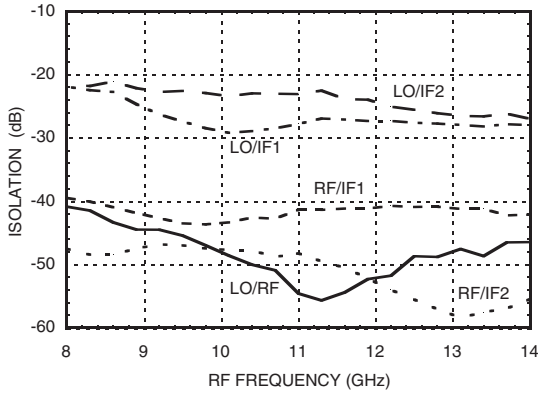

IF Bandwidth*

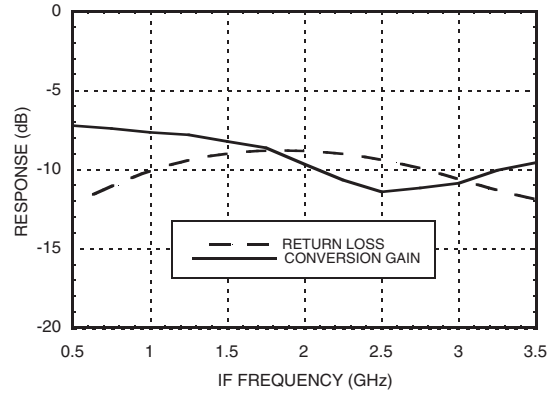

Amplitude Balance vs. LO Drive

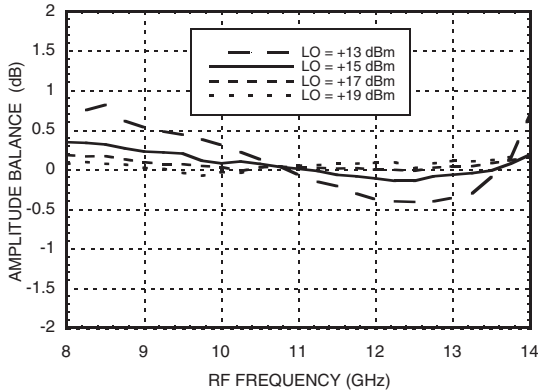

Phase Balance vs. LO Drive

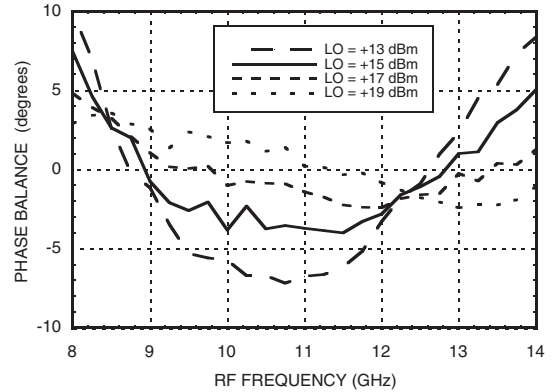

Upconverter Performance Conversion Gain vs. LO Drive

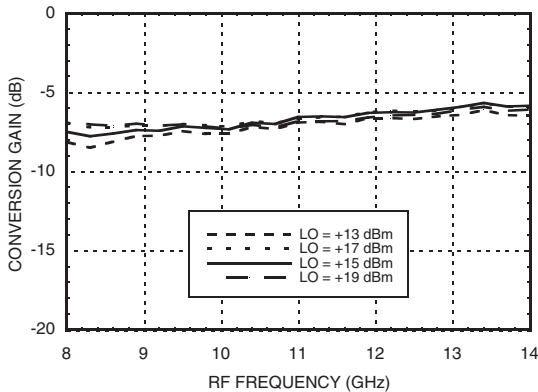

Upconverter Performance Sideband Rejection vs. LO Drive

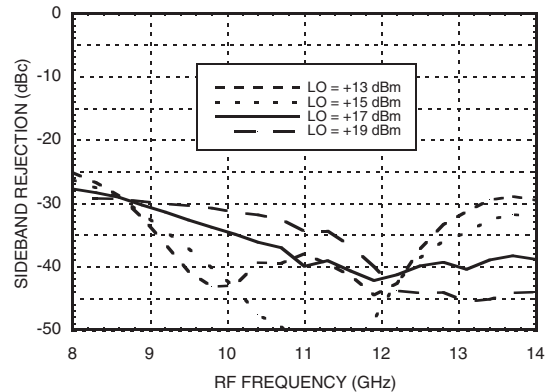

* Conversion gain data taken with external IF hybrid

Harmonics of LO

| LO Freq. (GHz) | nLO Spur at RF Port | | | |
|----------------|---------------------|----|----|----|
| | 1 | 2 | 3 | 4 |
| 8.5 | 42 | 44 | 44 | 70 |
| 9.5 | 50 | 53 | 59 | 77 |
| 10.5 | 51 | 54 | 63 | xx |
| 11.5 | 47 | 58 | 66 | xx |
| 12.5 | 45 | 59 | 70 | xx |
| 13.5 | 45 | 57 | xx | xx |

LO = + 15 dBm
Values in dBc below input LO level measured at RF Port.

MxN Spurious Outputs

| mRF | nLO | | | | |
|-----|-----|----|----|----|----|
| | 0 | 1 | 2 | 3 | 4 |
| 0 | xx | -5 | 29 | 23 | 52 |
| 1 | 27 | 0 | 51 | 59 | 81 |
| 2 | 92 | 85 | 76 | 82 | 92 |
| 3 | 92 | 92 | 92 | 92 | 92 |
| 4 | 92 | 92 | 92 | 92 | 92 |

RF = 10.6 GHz @ -10 dBm
LO = 10.5 GHz @ +15 dBm
Data taken without IF hybrid
All values in dBc below IF power level

Absolute Maximum Ratings

| | |
|--|----------------|
| RF / IF Input | +20 dBm |
| LO Drive | + 27 dBm |
| Channel Temperature | 150°C |
| Continuous P _{diss} (T=85°C) (derate 6.9 mW/°C above 85°C) | 460 mW |
| Thermal Resistance (R _{TH}) (junction to package bottom) | 141.4 °C/W |
| Storage Temperature | -65 to +150 °C |
| Operating Temperature | -55 to +85 °C |



**ELECTROSTATIC SENSITIVE DEVICE
OBSERVE HANDLING PRECAUTIONS**

NOTES:

1. PACKAGE BODY MATERIAL: ALUMINA
2. LEAD AND GROUND PADDLE PLATING: 30 - 80 MICROINCHES GOLD OVER 50 MICROINCHES MINIMUM NICKLE
3. DIMENSIONS ARE IN INCHES [MILLIMETERS]
4. LEAD SPACING TOLERANCE IS NON-CUMULATIVE
5. PACKAGE WARP SHALL NOT EXCEED 0.05mm DATUM
6. ALL GROUND LEADS AND GROUND PADDLE MUST BE SOLDERED TO PCB RF GROUND

Outline Drawing

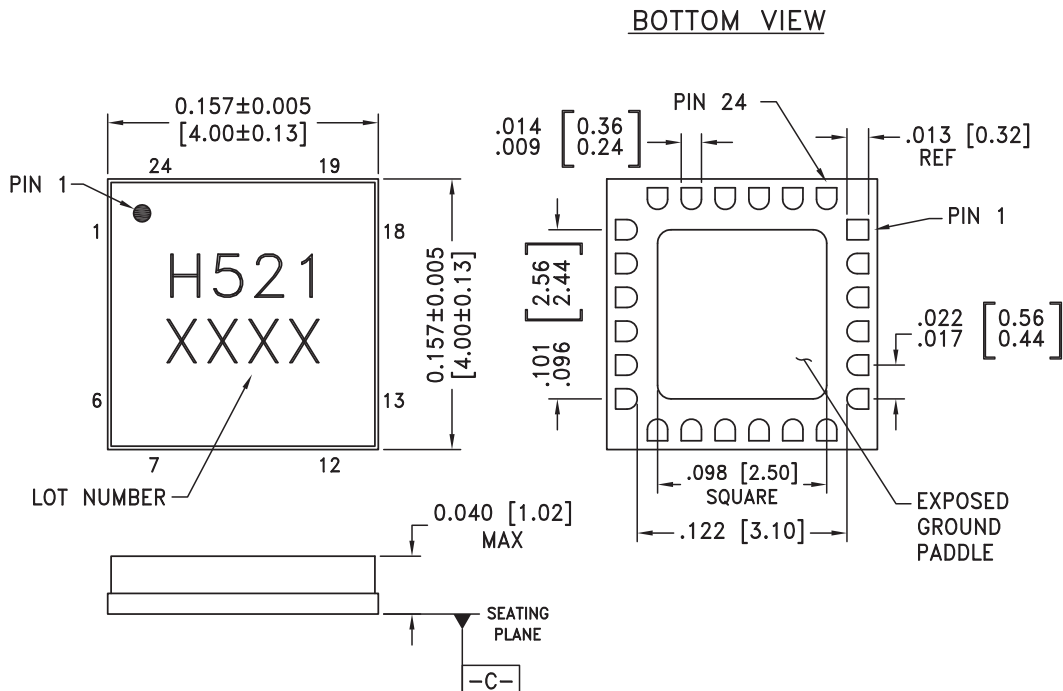

Pin Descriptions

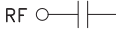
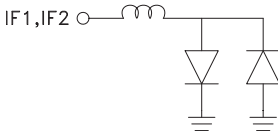
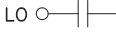
| Pin Number | Function | Description | Interface Schematic |
|------------------------------|----------|--|---|
| 1, 2, 6 - 8, 10, 13, 17 - 24 | N/C | No connection required. These pins may be connected to RF/DC ground without affecting performance. | |
| 3, 5, 12, 14, 16 | GND | These pins and package bottom must be connected to RF/DC ground. |  |
| 4 | RF | This pin is AC coupled and matched to 50 Ohms from 8.5 to 13.5 GHz. |  |
| 9 | IF1 | This pin is DC coupled. For applications not requiring operation to DC, this port should be DC blocked externally using a series capacitor whose value has been chosen to pass the necessary IF frequency range. For operation to DC, this pin must not source/sink more than 3mA of current or part non-function and possible part failure will result. |  |
| 11 | IF2 | | |
| 15 | LO | This pin is AC coupled and matched to 50 Ohms from 8.5 to 13.5 GHz. |  |

Evaluation PCB

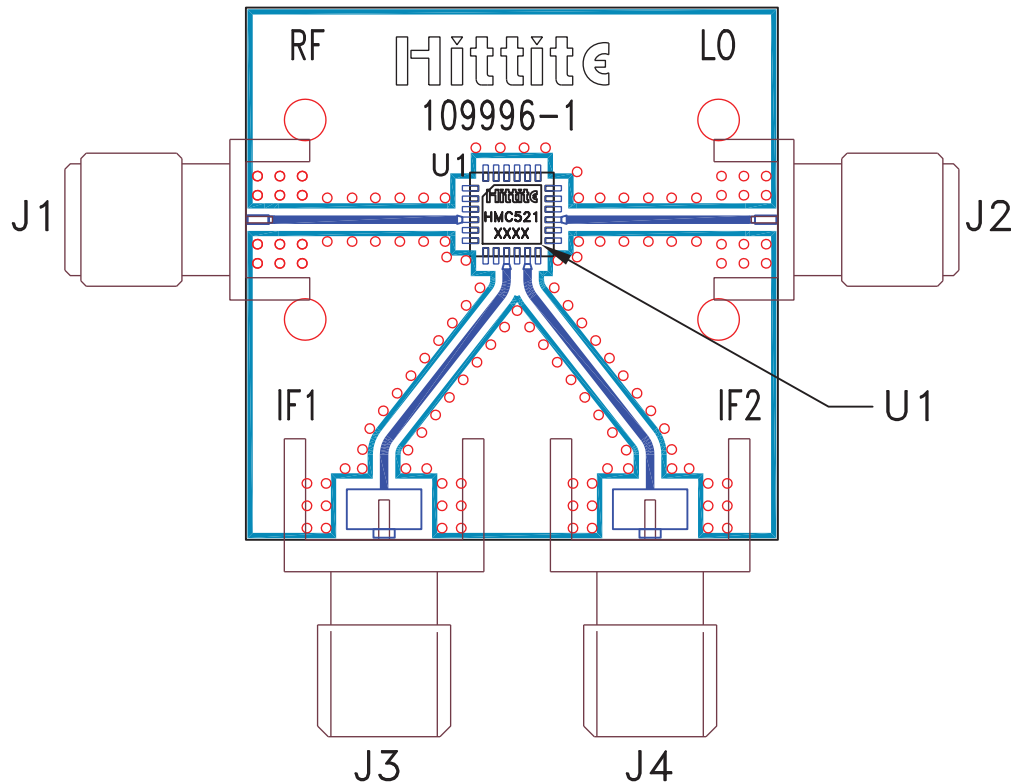

List of Materials for Evaluation PCB 109998 [1]

| Item | Description |
|---------|----------------------------------|
| J1 - J2 | PCB Mount SMA RF Connector, SRI |
| J3 - J4 | PCB Mount SMA Connector, Johnson |
| U1 | HMC521LC4 |
| PCB [2] | 109996 Evaluation Board |

[1] Reference this number when ordering complete evaluation PCB

[2] Circuit Board Material: Rogers 4350

The circuit board used in the final application should use RF circuit design techniques. Signal lines should have 50 ohm impedance while the package ground leads and exposed paddle should be connected directly to the ground plane similar to that shown. A sufficient number of via holes should be used to connect the top and bottom ground planes. The evaluation circuit board shown is available from Hittite upon request.