

REPETITIVE AVALANCHE AND dv/dt RATED HEXFET® TRANSISTOR

IRHN7130 IRHN8130 N-CHANNEL MEGA RAD HARD

100 Volt, 0.18Ω, MEGA RAD HARD HEXFET

International Rectifier's MEGA RAD HARD technology HEXFETs demonstrate excellent threshold voltage stability and breakdown voltage stability at total radiation doses as high as 1×10^6 Rads (Si). Under **identical** pre- and post-radiation test conditions, International Rectifier's RAD HARD HEXFETs retain **identical** electrical specifications up to 1×10^5 Rads (Si) total dose. At 1×10^6 Rads (Si) total dose, under the same pre-dose conditions, only minor shifts in the electrical specifications are observed and are so specified in table 1. No compensation in gate drive circuitry is required. In addition, these devices are capable of surviving transient ionization pulses as high as 1×10^{12} Rads (Si)/Sec, and return to normal operation within a few microseconds. Single Event Effect (SEE) testing of International Rectifier RAD HARD HEXFETs has demonstrated virtual immunity to SEE failure. Since the MEGA RAD HARD process utilizes International Rectifier's patented HEXFET technology, the user can expect the highest quality and reliability in the industry.

RAD HARD HEXFET transistors also feature all of the well-established advantages of MOSFETs, such as voltage control, very fast switching, ease of paralleling and temperature stability of the electrical parameters.

They are well-suited for applications such as switching power supplies, motor controls, inverters, choppers, audio amplifiers and high-energy pulse circuits in space and weapons environments.

Product Summary

Part Number	BV _{DSS}	R _{DS(on)}	Id
IRHN7130	100V	0.18Ω	14
IRHN8130	100V	0.18Ω	14

Features:

- Radiation Hardened up to 1×10^6 Rads (Si)
- Single Event Burnout (SEB) Hardened
- Single Event Gate Rupture (SEGR) Hardened
- Gamma Dot (Flash X-Ray) Hardened
- Neutron Tolerant
- Identical Pre- and Post-Electrical Test Conditions
- Repetitive Avalanche Rating
- Dynamic dv/dt Rating
- Simple Drive Requirements
- Ease of Paralleling
- Hermetically Sealed
- Surface Mount
- Light-weight

Absolute Maximum Ratings

Pre-Radiation

	Parameter	IRHN7130, IRHN8130	Units
Id @ VGS = 12V, TC = 25°C	Continuous Drain Current	14	A
Id @ VGS = 12V, TC = 100°C	Continuous Drain Current	9.0	
IdM	Pulsed Drain Current ①	56	
PD @ TC = 25°C	Max. Power Dissipation	75	W
	Linear Derating Factor	0.60	W/K ⑤
VGS	Gate-to-Source Voltage	±20	V
EAS	Single Pulse Avalanche Energy ②	160 (see fig. 29)	mJ
IAR	Avalanche Current ①	14	A
EAR	Repetitive Avalanche Energy ①	7.5	mJ
dv/dt	Peak Diode Recovery dv/dt ③	5.5 (see fig. 30)	V/ns
TJ	Operating Junction	-55 to 150	°C
TSTG	Storage Temperature Range		
	Package Mounting Surface Temperature	300 (for 5 sec.)	
	Weight	2.6 (typical)	g

Electrical Characteristics @ T_j = 25°C (Unless Otherwise Specified)

	Parameter	Min.	Typ.	Max.	Units	Test Conditions
BV _{DSS}	Drain-to-Source Breakdown Voltage	100	—	—	V	V _{GS} = 0V, I _D = 1.0 mA
ΔBV _{DSS} /ΔT _J	Temperature Coefficient of Breakdown Voltage	—	0.12	—	V/°C	Reference to 25°C, I _D = 1.0 mA
RDS(on)	Static Drain-to-Source	—	—	0.18	Ω	V _{GS} = 12V, I _D = 9A
	On-State Resistance	—	—	0.20		V _{GS} = 12V, I _D = 14A ④
VGS(th)	Gate Threshold Voltage	2.0	—	4.0	V	V _{DS} = V _{GS} , I _D = 1.0 mA
gfs	Forward Transconductance	3.3	—	—	S (r)	V _{DS} > 15V, I _{DS} = 9A ④
IDSS	Zero Gate Voltage Drain Current	—	—	25	μA	V _{DS} = 0.8 x Max Rating, V _{GS} = 0V
		—	—	250		V _{DS} = 0.8 x Max Rating V _{GS} = 0V, T _J = 125°C
IGSS	Gate-to-Source Leakage Forward	—	—	100	nA	V _{GS} = 20V
IGSS	Gate-to-Source Leakage Reverse	—	—	-100	nA	V _{GS} = -20V
Qg	Total Gate Charge	—	—	45	nC	V _{GS} = 12V, I _D = 14A
Qgs	Gate-to-Source Charge	—	—	11		V _{DS} = Max. Rating x 0.5 (see figure 23 and 31)
Qgd	Gate-to-Drain ('Miller') Charge	—	—	17		
td(on)	Turn-On Delay Time	—	—	30	ns	V _{DD} = 50V, I _D = 14A, R _G = 7.5Ω (see figure 28)
tr	Rise Time	—	—	120		
td(off)	Turn-Off Delay Time	—	—	49		
tf	Fall Time	—	—	64		
LD	Internal Drain Inductance	—	2.0	—	nH	Measured from the drain lead, 6mm (0.25 in.) from package to center of die.
LS	Internal Source Inductance	—	4.1	—		Measured from the source lead, 6mm (0.25 in.) from package to source bonding pad.
Ciss	Input Capacitance	—	1100	—	pF	V _{GS} = 0V, V _{DS} = 25V f = 1.0 MHz (see figure 22)
Coss	Output Capacitance	—	310	—		
Crss	Reverse Transfer Capacitance	—	55	—		

Source-Drain Diode Ratings and Characteristics

	Parameter	Min.	Typ.	Max.	Units	Test Conditions
I _S	Continuous Source Current (Body Diode)	—	—	14	A	Modified MOSFET symbol showing the integral reverse p-n junction rectifier.
I _{SM}	Pulse Source Current (Body Diode) ①	—	—	56		
V _{SD}	Diode Forward Voltage	—	—	1.8	V	T _j = 25°C, I _S = 14A, V _{GS} = 0V ④
t _{rr}	Reverse Recovery Time	—	—	370	ns	T _j = 25°C, I _F = 14A, di/dt ≤ 100A/μs V _{DD} ≤ 50V ④
QRR	Reverse Recovery Charge	—	—	3.5	μC	
t _{on}	Forward Turn-On Time	Intrinsic turn-on time is negligible. Turn-on speed is substantially controlled by L _S + L _D .				

Thermal Resistance

	Parameter	Min.	Typ.	Max.	Units	Test Conditions
R _{thJC}	Junction-to-Case	—	—	1.67	K/W [®]	soldered to a copper-clad PC board
R _{thJ-PCB}	Junction-to-PC board	—	TBD	—		

IRHN7130, IRHN8130 Devices

Radiation Characteristics

Radiation Performance of Mega Rad Hard HEXFETs

International Rectifier Radiation Hardened HEX-FETs are tested to verify their hardness capability. The hardness assurance program at International Rectifier uses two radiation environments.

Every manufacturing lot is tested in a low dose rate (total dose) environment per MIL-STD-750, test method 1019. International Rectifier has imposed a standard gate voltage of 12 volts per note 6 and figure 8a and a V_{DSS} bias condition equal to 80% of the device rated voltage per note 7 and figure 8b. Pre- and post-radiation limits of the devices irradiated to 1×10^5 Rads (Si) are identical and are presented in Table 1, column 1, IRHN7130. Device performance limits at a post radiation level of 1×10^6 Rads (Si) are presented in Table 1, column 2, IRHN8130. The values in Table 1 will be met for either of the two low dose rate test circuits that are used. Typical delta curves showing radiation response appear in figures 1 through 5. Typical post-radiation curves appear in figures 10 through 17.

Both pre- and post-radiation performance are tested and specified using the same drive circuitry and test conditions in order to provide a direct comparison. It should be noted that at a radiation level of 1×10^5 Rads (Si), no change in limits are specified in DC parameters. At a radiation level of 1×10^6 Rads (Si), leakage remains low and the device is usable with no change in drive circuitry required.

High dose rate testing may be done on a special request basis, using a dose rate up to 1×10^{12} Rads (Si)/Sec. Photocurrent and transient voltage waveforms are shown in figure 7, and the recommended test circuit to be used is shown in figure 9.

International Rectifier radiation hardened HEXFETs have been characterized in neutron and heavy ion Single Event Effects (SEE) environments. The effects on bulk silicon of the type used by International Rectifier on RAD HARD HEXFETs are shown in figure 6. Single Event Effects characterization is shown in Table 3.

Table 1. Low Dose Rate ⑥ ⑦

Parameter	IRHN7130		IRHN8130		Units	Test Conditions ⑩
	100K Rads (Si) min.	max.	1000K Rads (Si) min.	max.		
BV_{DSS} Drain-to-Source Breakdown Voltage	100	—	100	—	V	$V_{GS} = 0V, I_D = 1.0 \text{ mA}$
$V_{GS(th)}$ Gate Threshold Voltage ④	2.0	4.0	1.25	4.5		$V_{GS} = V_{DS}, I_D = 1.0 \text{ mA}$
I_{GSS} Gate-to-Source Leakage Forward	—	100	—	100	nA	$V_{GS} = +20V$
I_{GSS} Gate-to-Source Leakage Reverse	—	-100	—	-100		$V_{GS} = -20V$
I_{DSS} Zero Gate Voltage Drain Current	—	25	—	25	μA	$V_{DS} = 0.8 \times \text{Max Rating}, V_{GS} = 0$
$R_{DS(on)1}$ Static Drain-to-Source ④ On-State Resistance One	—	0.18	—	0.24	Ω	$V_{GS} = 12V, I_D = 9A$
V_{SD} Diode Forward Voltage ④	—	1.8	—	1.8	V	$T_C = 25^\circ C, I_S = 14A, V_{GS} = 0V$

Table 2. High Dose Rate ⑧

Parameter	10 ¹¹ Rads (Si)/sec			10 ¹² Rads (Si)/sec			Units	Test Conditions
	Min.	Typ.	Max.	Min.	Typ.	Max.		
V_{DSS} Drain-to-Source Voltage	—	—	80	—	—	80	V	Applied drain-to-source voltage during gamma-dot
I_{pp}	—	100	—	—	100	—	A	Peak radiation induced photo-current
di/dt	—	—	1000	—	—	200	A/ μ sec	Rate of rise of photo-current
L1	0.1	—	—	0.5	—	—	μH	Circuit inductance required to limit di/dt

Table 3. Single Event Effects ⑨

Parameter	Typ.	Units	Ion	LET (Si) (MeV/mg/cm ²)	Fluence (ions/cm ²)	Range (μm)	V_{DS} Bias (V)	V_{GS} Bias (V)
BV_{DSS}	100	V	Ni	28	1×10^6	~41	100	-5

IRHN7130, IRHN8130 Devices

Post-Radiation

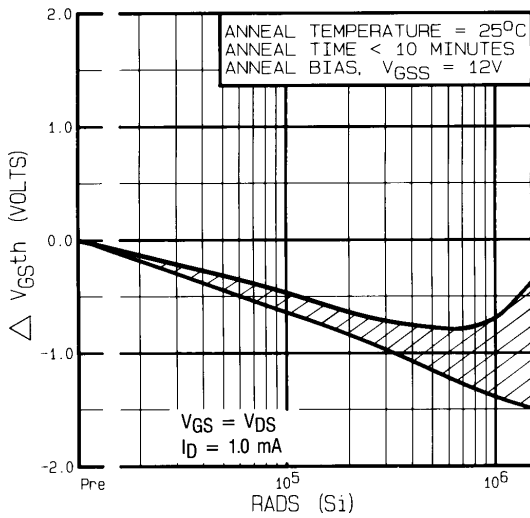

Figure 1. – Typical Response of Gate Threshold Voltage Vs. Total Dose Exposure.

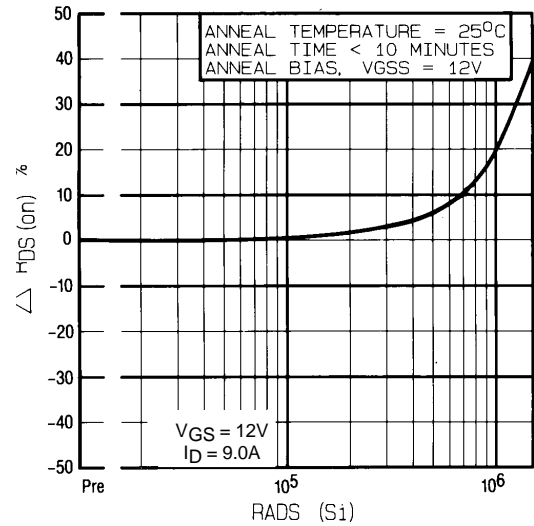

Figure 2. – Typical Response of On-State Resistance Vs. Total Dose Exposure.

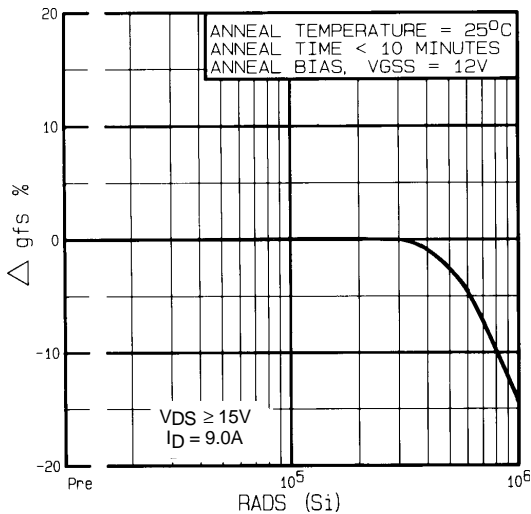

Figure 3. – Typical Response of Transconductance Vs. Total Dose Exposure.

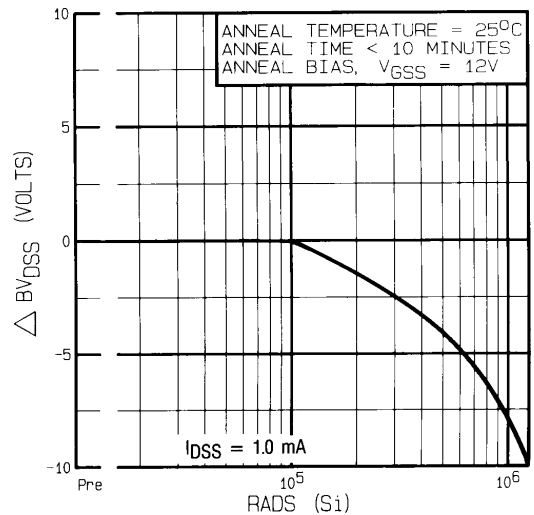

Figure 4. – Typical Response of Drain-to-Source Breakdown Vs. Total Dose Exposure.

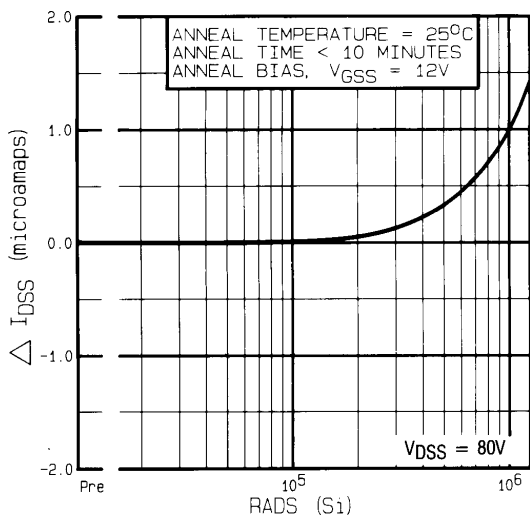

Figure 5. – Typical Zero Gate Voltage Drain Current Vs. Total Dose Exposure.

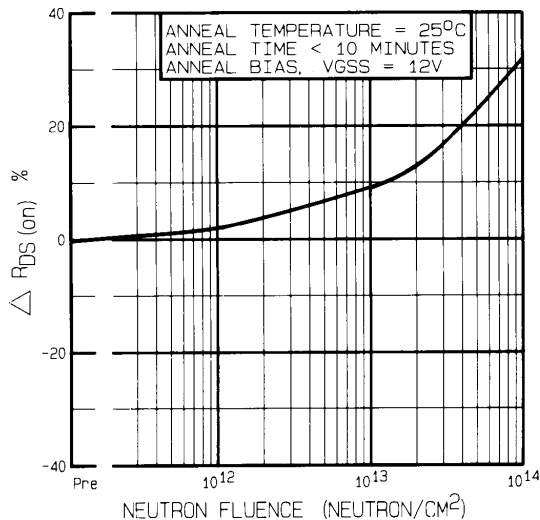

Figure 6. – Typical On-State Resistance Vs. Neutron Fluence Level

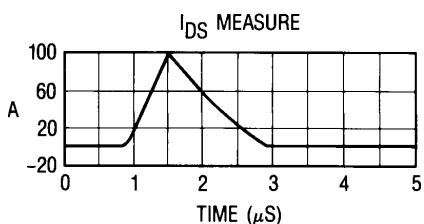
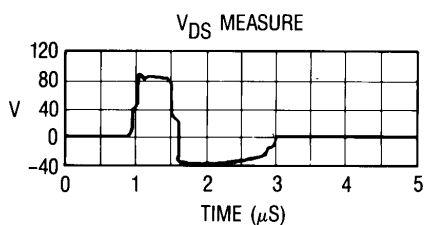

Figure 7. – Typical Transient Response of Rad Hard HEXFET During 1×10^{12} Rad (Si)/Sec Exposure.

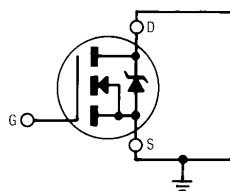

Figure 8a – Gate Stress of VGSS Equals 12 Volts During Radiation.

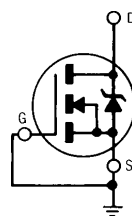

Figure 8b – V_{DSS} Stress Equals 80% of BV_{DSS} During Radiation.

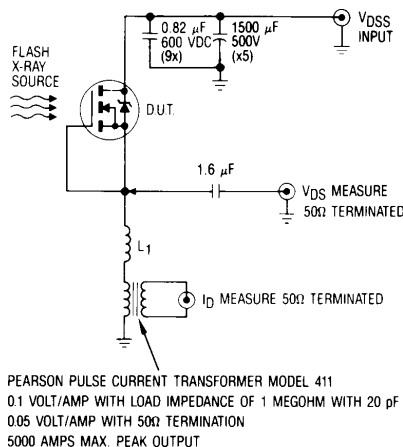

Figure 9. – High Dose Rate (Gamma Dot) Test Circuit

IRHN7130, IRHN8130 Devices

Radiation Characteristics

Note: Bias Conditions during radiation; $V_{GS} = 12\text{ V}_{dc}$, $V_{DS} = 0\text{ V}_{dc}$

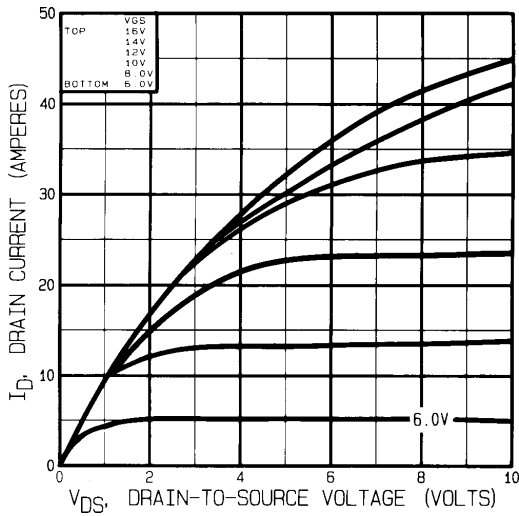

Figure 10. – Typical Output Characteristics Pre-Radiation.

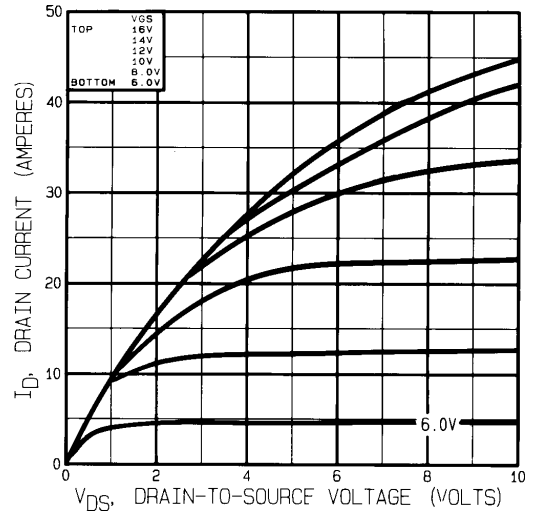

Figure 11. – Typical Output Characteristics, Post Radiation 100K Rads (Si).

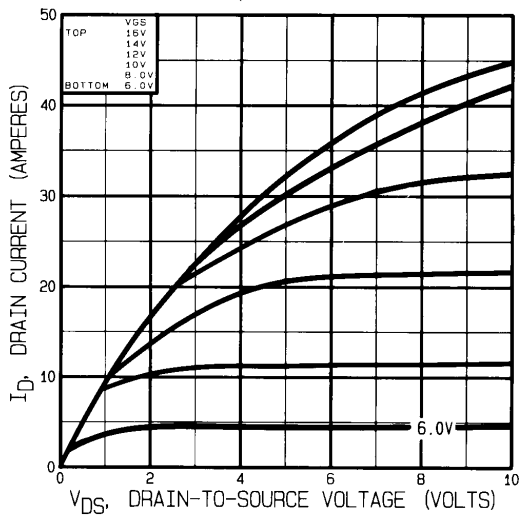

Figure 12. – Typical Output Characteristics Post-Radiation 300K Rads (Si).

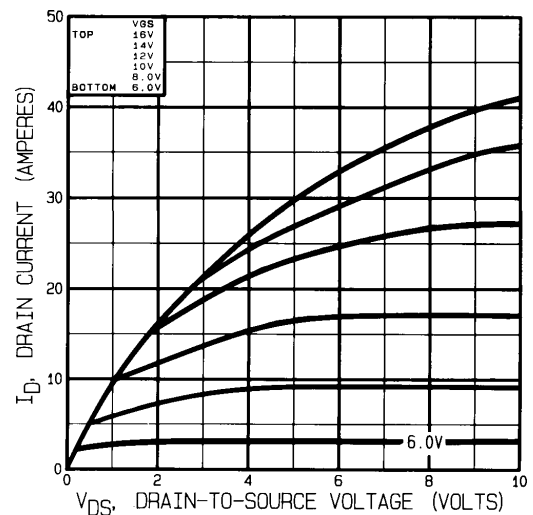

Figure 13. – Typical Output Characteristics Post-Radiation 1 Mega Rads (Si)

IRHN7130, IRHN8130 Devices

Radiation Characteristics

Note: Bias Conditions during radiation; $V_{GS} = 12\text{ V}_{dc}$, $V_{DS} = 0\text{ V}_{dc}$

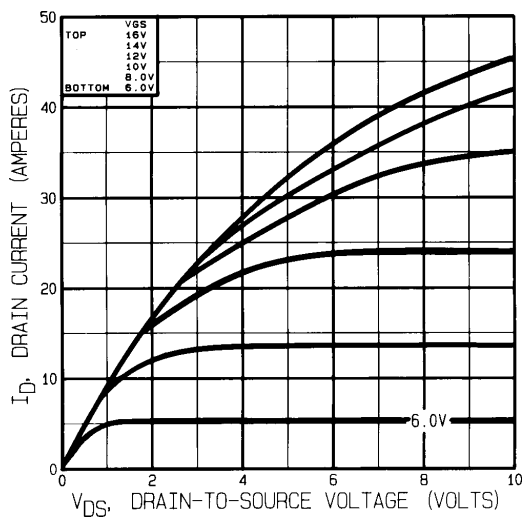

Figure 14. – Typical Output Characteristics Pre-Radiation.

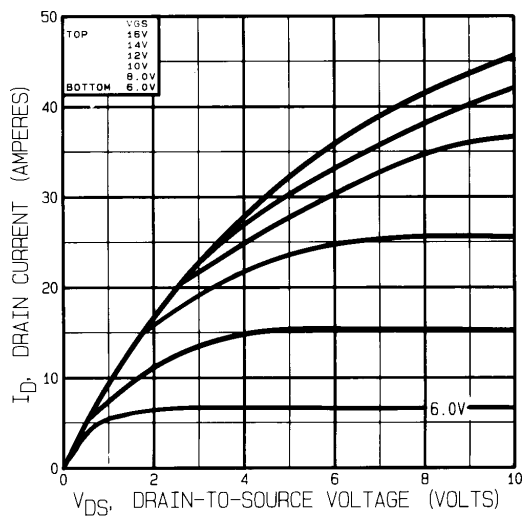

Figure 15. – Typical Output Characteristics, Post-Radiation 100K Rads (Si).

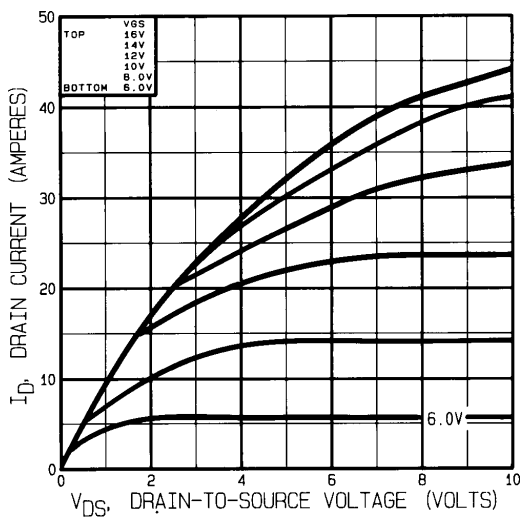

Figure 16. – Typical Output Characteristics, Post-Radiation 300K Rads (Si).

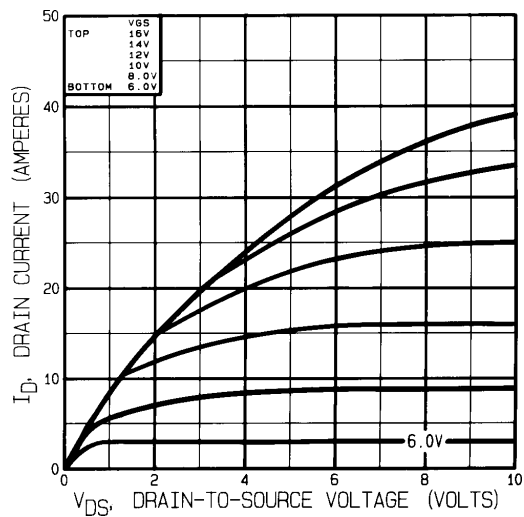

Figure 17. – Typical Output Characteristics, Post-Radiation 1 Mega Rads (Si).

IRHN7130, IRHN8130 Devices

Pre-Radiation

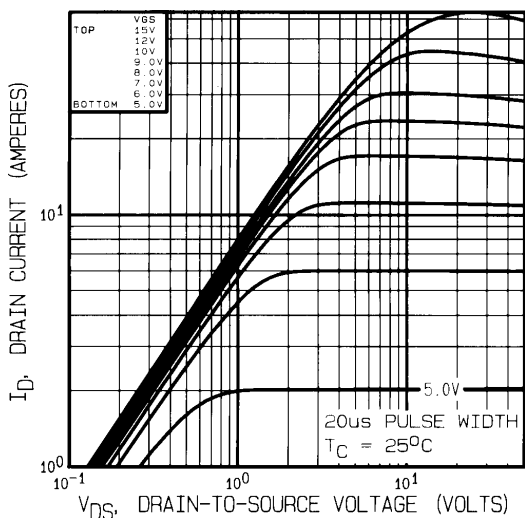

Figure 18. – Typical Output Characteristics, $T_C = 25^\circ\text{C}$

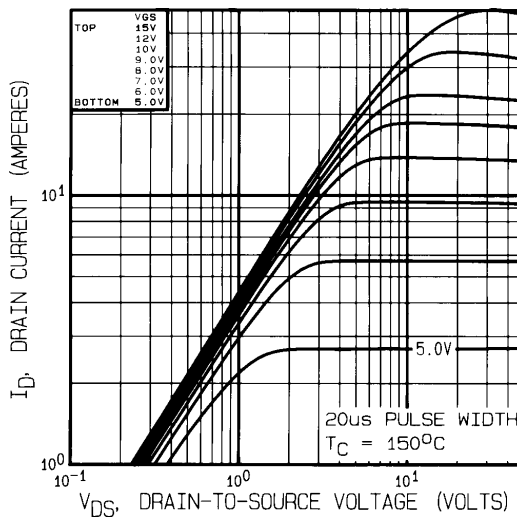

Figure 19. – Typical Output Characteristics, $T_C = 150^\circ\text{C}$

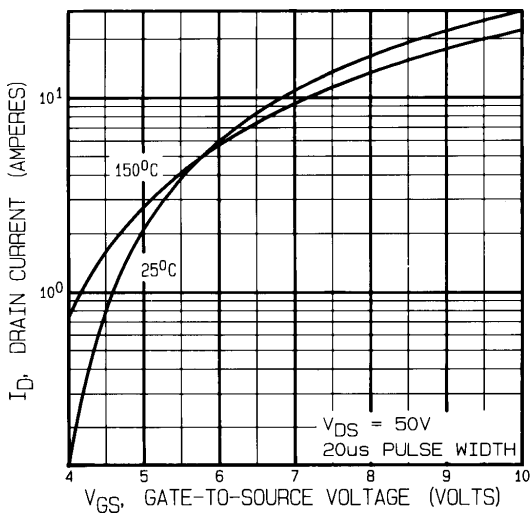

Figure 20. – Typical Transfer Characteristics

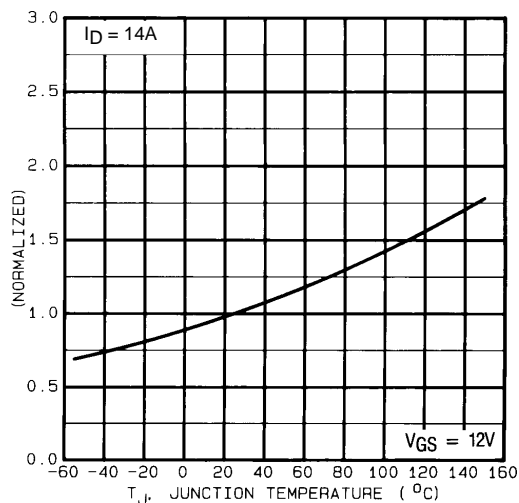

Figure 21. – Normalized On-Resistance Vs. Temperature

IRHN7130, IRHN8130 Devices

Pre-Radiation

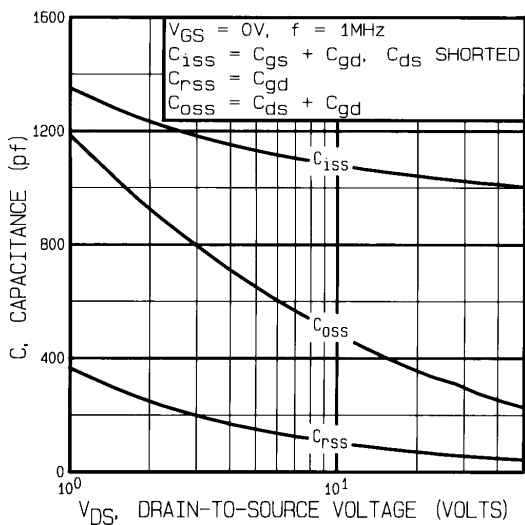

Figure 22. – Typical Capacitance Vs. Drain-to-Source Voltage.

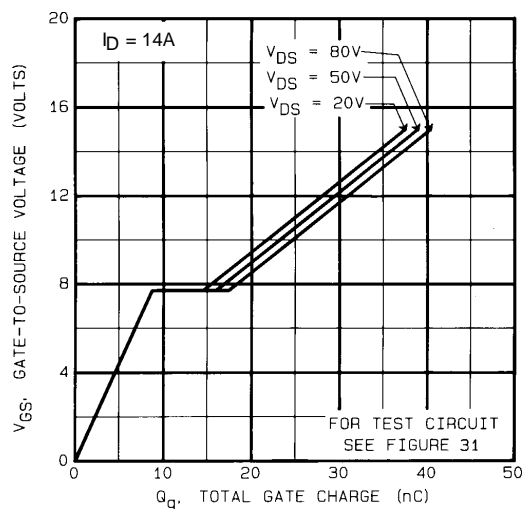

Figure 23. – Typical Gate Charge Vs. Gate-to-Source Voltage.

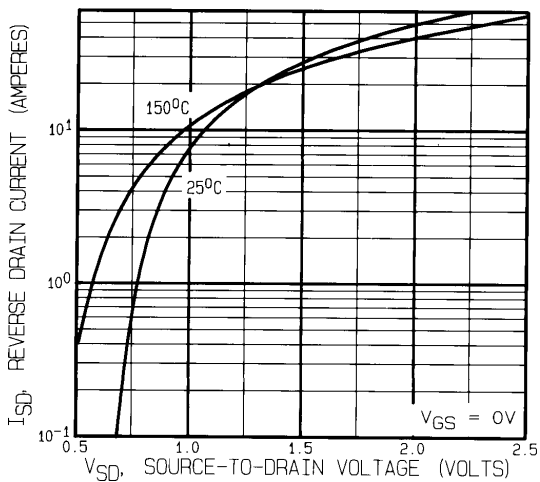

Figure 24. – Typical Source-Drain Diode Forward Voltage

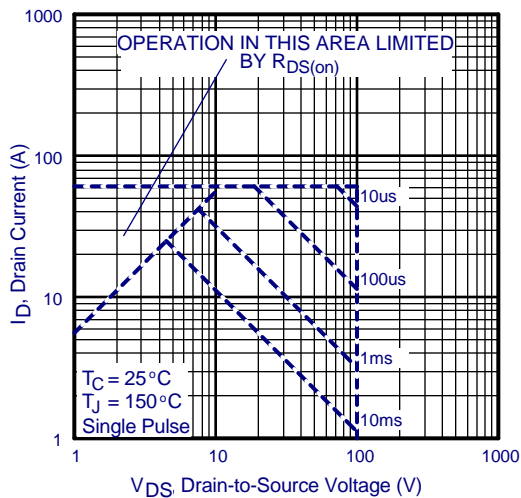

Figure 25. – Maximum Safe Operating Area

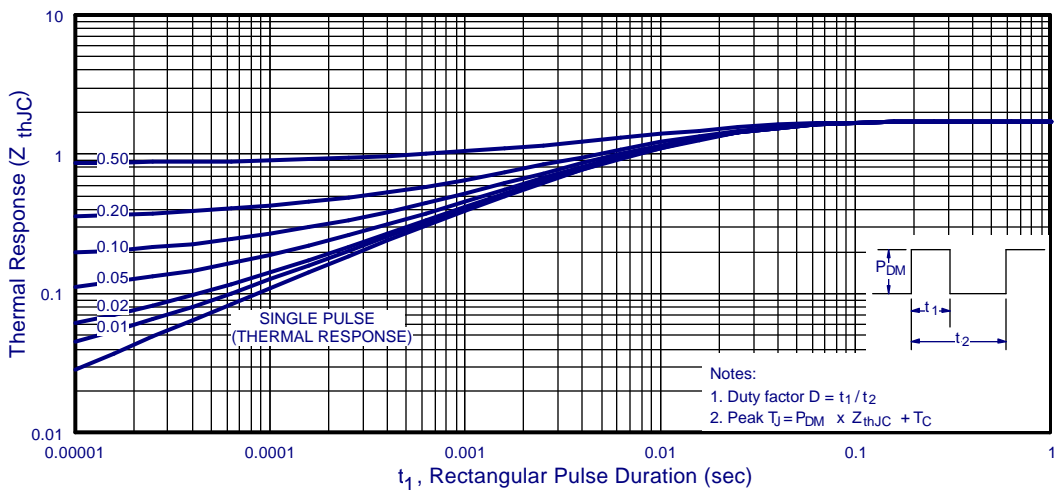

Figure 26. – Maximum Effective Transient Thermal Impedance, Junction-to-Case Vs. Pulse Duration

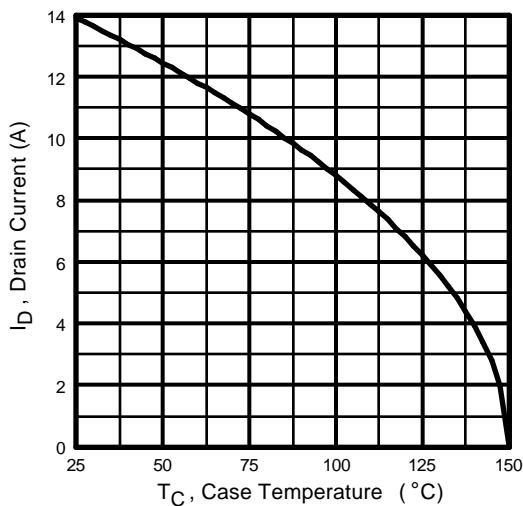

Figure 27. – Maximum Drain Current Vs. Case Temperature.

IRHN7130, IRHN8130 Devices

Pre-Radiation

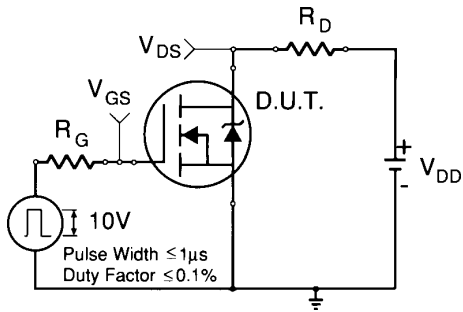

Figure 28a – Switching Time Test Circuit

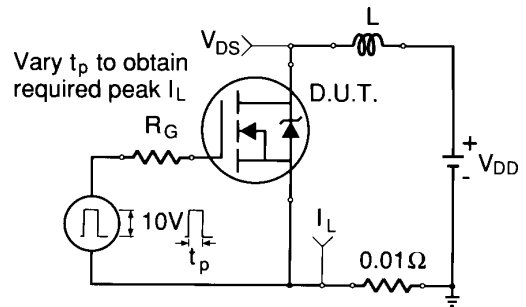

Figure 29a – Unclamped Inductive Test Circuit

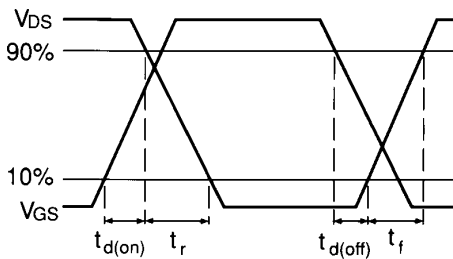

Figure 28b – Switching Time Waveforms

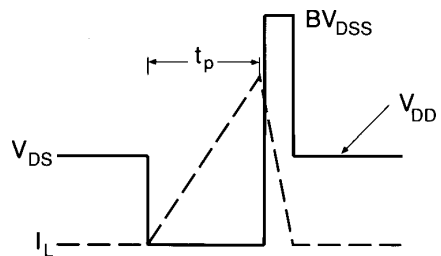

Figure 29b – Unclamped Inductive Waveforms

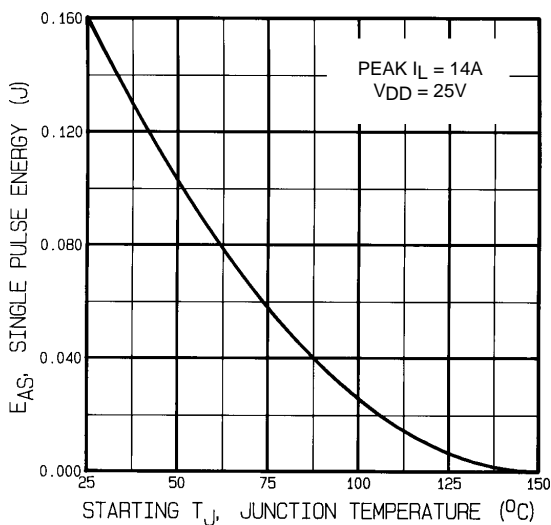

Figure 29c – Maximum Avalanche Energy Vs. Starting Junction Temperature.

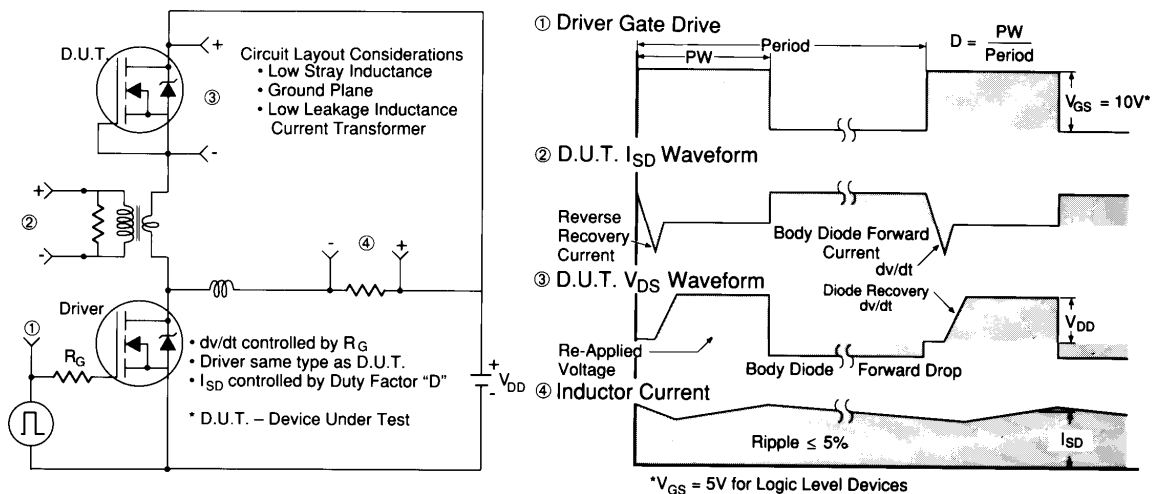

Figure 30 – Peak Diode Recovery dv/dt Test Circuit

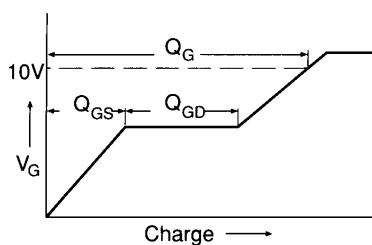

Figure 31a – Basic Gate Waveform

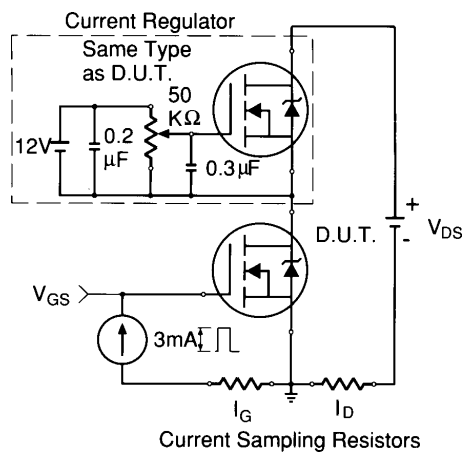

Figure 31b – Gate Charge Test Circuit

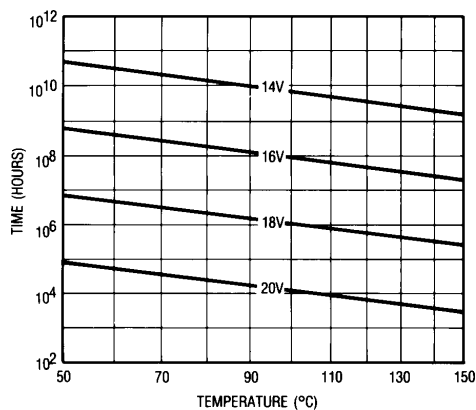

Figure 32. – Typical Time to Accumulated 1% Failure

IRHN7130, IRHN8130 Devices

Radiation Characteristics

- ① Repetitive Rating; Pulse width limited by maximum junction temperature. (figure 26)
Refer to current HEXFET reliability report.
- ② @ $V_{DD} = 25V$, Starting $T_J = 25^\circ C$, Peak $I_L = 14A$,
 $E_{AS} = [0.5 * L * (I_L^2) * [BV_{DSS}/(BV_{DSS}-V_{DD})]]$
 $V_{GS} = 12V$, $25 \leq R_G \leq 200\Omega$
- ③ $I_{SD} \leq 14A$, $di/dt \leq 140 A/\mu s$,
 $V_{DD} \leq BV_{DSS}$, $T_J \leq 150^\circ C$
Suggested $R_G = 7.5\Omega$
- ④ Pulse width $\leq 300 \mu s$; Duty Cycle $\leq 2\%$
- ⑤ $K/W = ^\circ C/W$
 $W/K = W/^\circ C$
- ⑥ **Total Dose Irradiation with V_{GS} Bias.**
12 volt V_{GS} applied and $V_{DS} = 0$ during irradiation per MIL-STD-750, method 1019. (figure 8a)
- ⑦ **Total Dose Irradiation with V_{DS} Bias.**
 $V_{DS} = 0.8 \times$ rated BV_{DSS} (pre-radiation) applied and $V_{GS} = 0$ during irradiation per MIL-STD-750, method 1019. (figure 8b)
- ⑧ This test is performed using a flash x-ray source operated in the e-beam mode (energy ~ 2.5 MeV), 30 nsec pulse. (figure 9)
- ⑨ Study sponsored by NASA. Evaluation performed at Brookhaven National Labs.
- ⑩ All Pre-Radiation and Post-Radiation test conditions are **identical** to facilitate direct comparison for circuit applications.

Case Outline and Dimensions – SMD-1

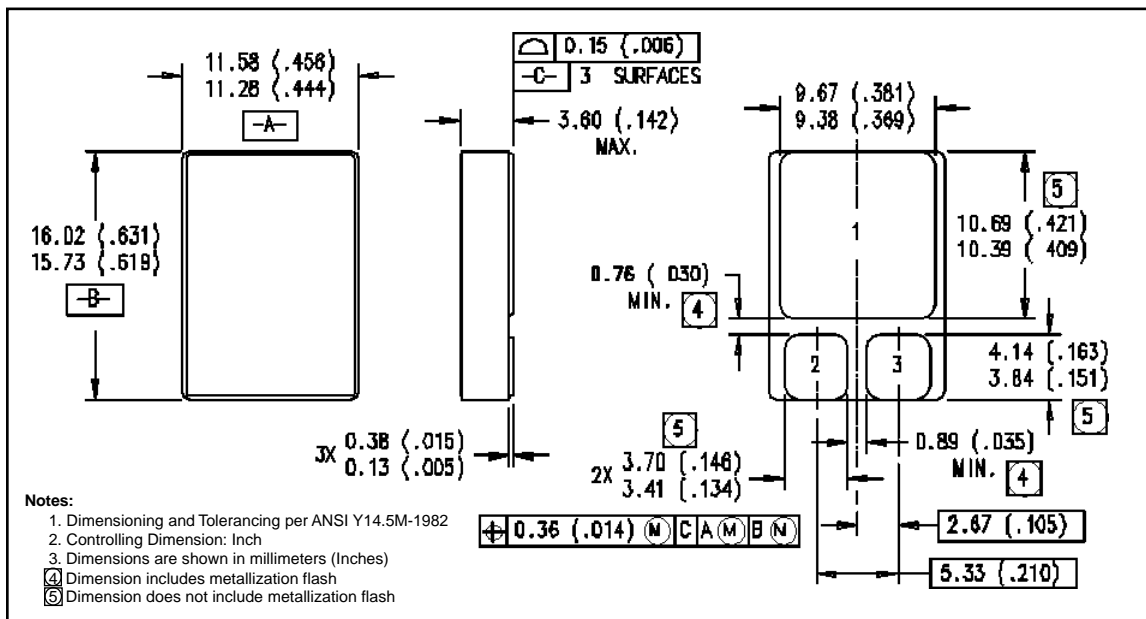

International
IOR Rectifier

WORLD HEADQUARTERS: 233 Kansas St., El Segundo, California 90245, Tel: (310) 322 3331

EUROPEAN HEADQUARTERS: Hurst Green, Oxted, Surrey RH8 9BB, UK Tel: ++ 44 1883 732020

IR CANADA: 7321 Victoria Park Ave., Suite 201, Markham, Ontario L3R 2Z8, Tel: (905) 475 1897

IR GERMANY: Saalburgstrasse 157, 61350 Bad Homburg Tel: ++ 49 6172 96590

IR ITALY: Via Liguria 49, 10071 Borgaro, Torino Tel: ++ 39 11 451 0111

IR FAR EAST: K&H Bldg., 2F, 3-30-4 Nishi-Ikeburo 3-Chome, Toshima-Ki, Tokyo Japan 171 Tel: 81 3 3983 0086

IR SOUTHEAST ASIA: 315 Outram Road, #10-02 Tan Boon Liat Building, Singapore 0316 Tel: 65 221 8371

<http://www.irf.com/>

Data and specifications subject to change without notice.

9/96