

SHINDENGEN

Schottky Rectifiers (SBD)

Dual

SF30JC10

100V 30A

OUTLINE DIMENSIONS

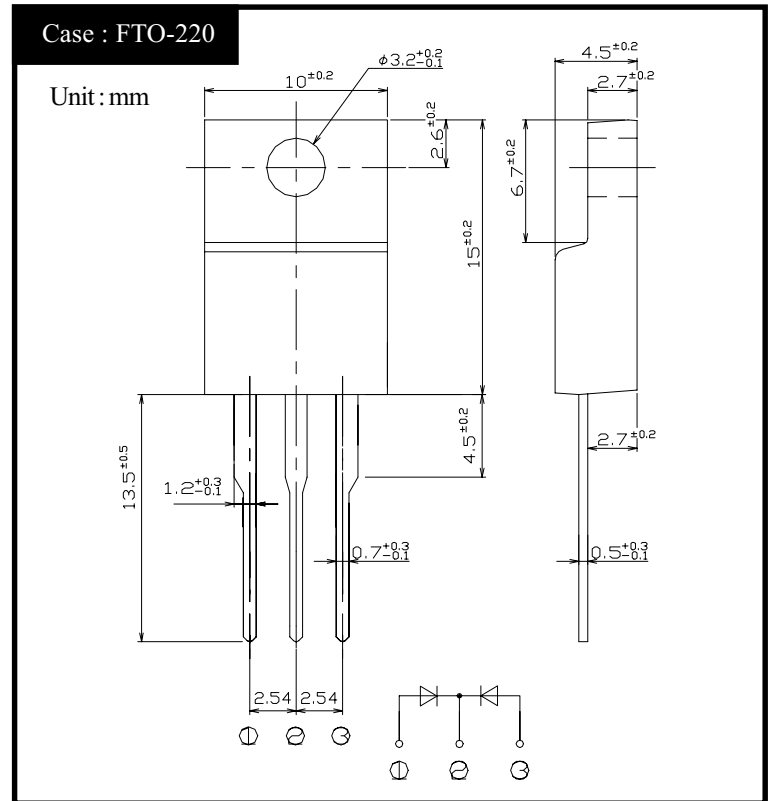

RATINGS

● Absolute Maximum Ratings (If not specified, Tc=25°C)

Item	Symbol	Conditions	Ratings	Unit
Storage Temperature	Tstg		-55~150	°C
Operating Junction Temperature	Tj		150	°C
Maximum Reverse Voltage	V _{RM}		100	V
Average Rectified Forward Current	I _O	50Hz sine wave, R-load, Rating for each diode I _O /2, Tc=97°C	30	A
Peak Surge Forward Current	I _{FSM}	50Hz sine wave, Non-repetitive 1 cycle peak value, Tj=25°C	300	A
Dielectric Strength	V _{dis}	Terminals to case, AC 1 minute	2.0	kV
Mounting Torque	TOR	(Recommended torque : 0.3N·m)	0.5	N·m

● Electrical Characteristics (If not specified, Tc=25°C)

Item	Symbol	Conditions	Ratings	Unit
Forward Voltage	V _F	I _F =15A, Pulse measurement, Rating of per diode	Max 0.86	V
Reverse Current	I _R	V _R =V _{RM} , Pulse measurement, Rating of per diode	Max 1.0	mA
Junction Capacitance	C _j	f=1MHz, V _R =10V, Rating of per diode	Typ 390	pF
Thermal Resistance	θ _{jc}	junction to case	Max 2.0	°C/W

SF30JC10 Forward Voltage

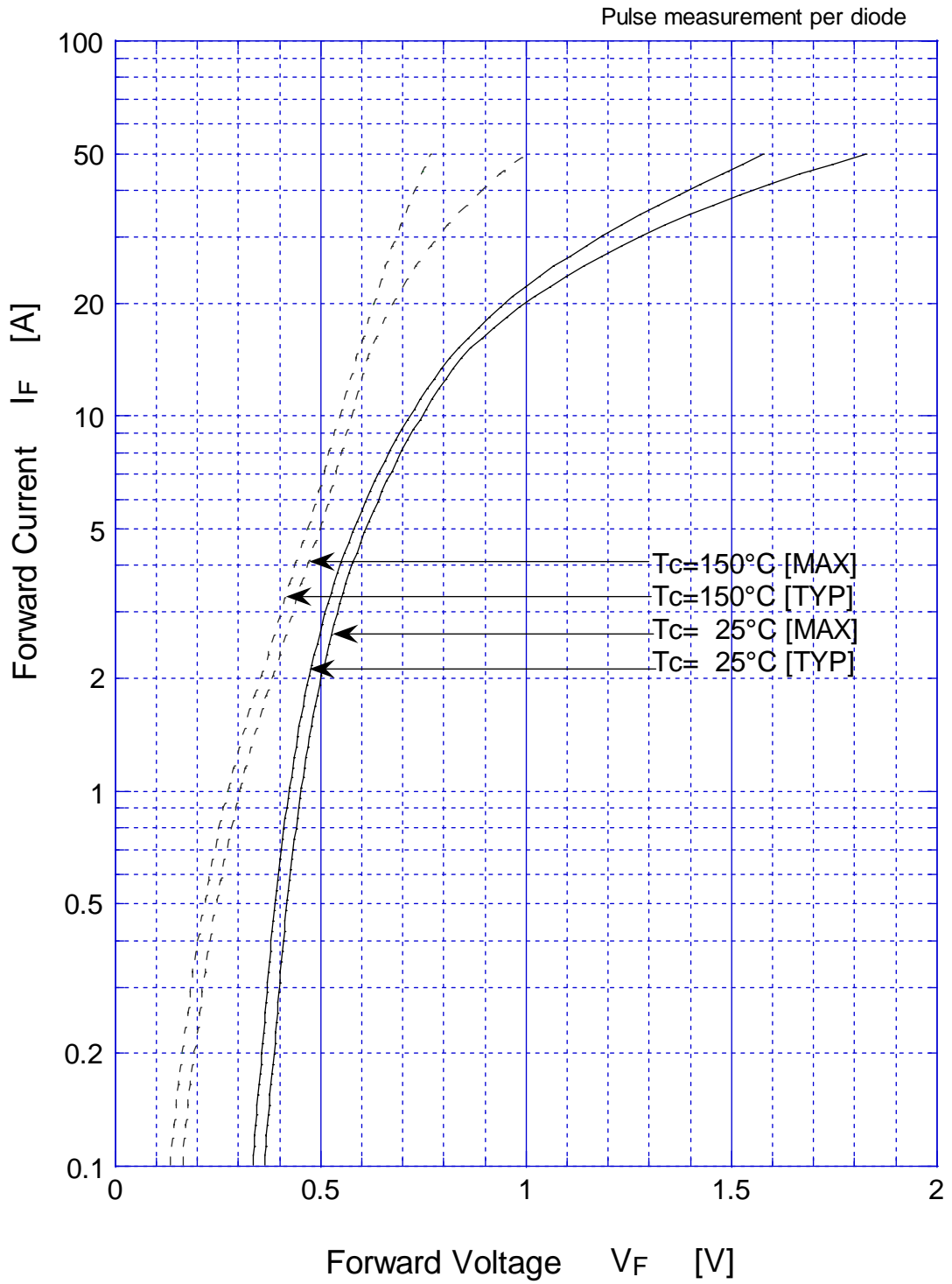

SF30JC10 Reverse Current

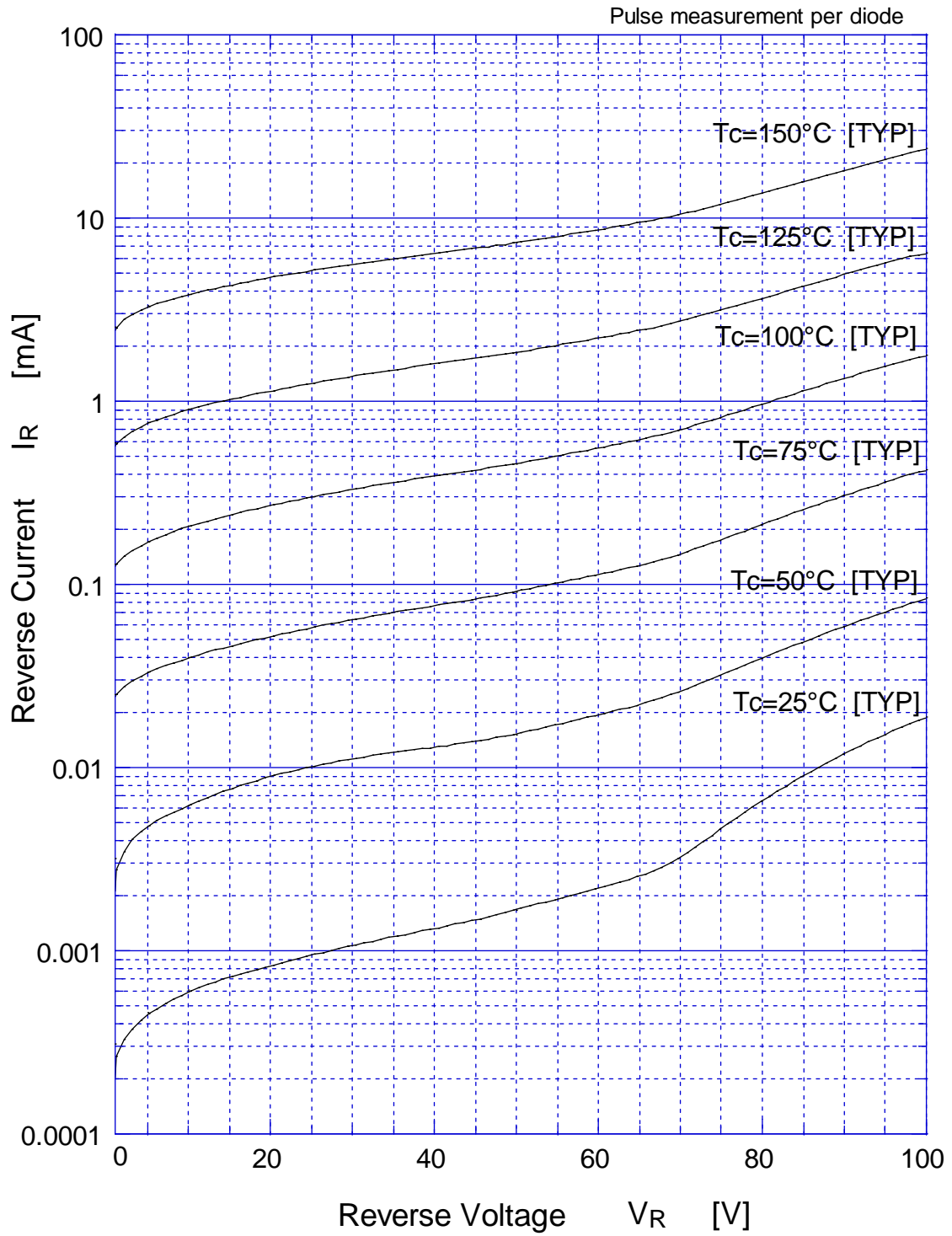

SF30JC10 Forward Power Dissipation

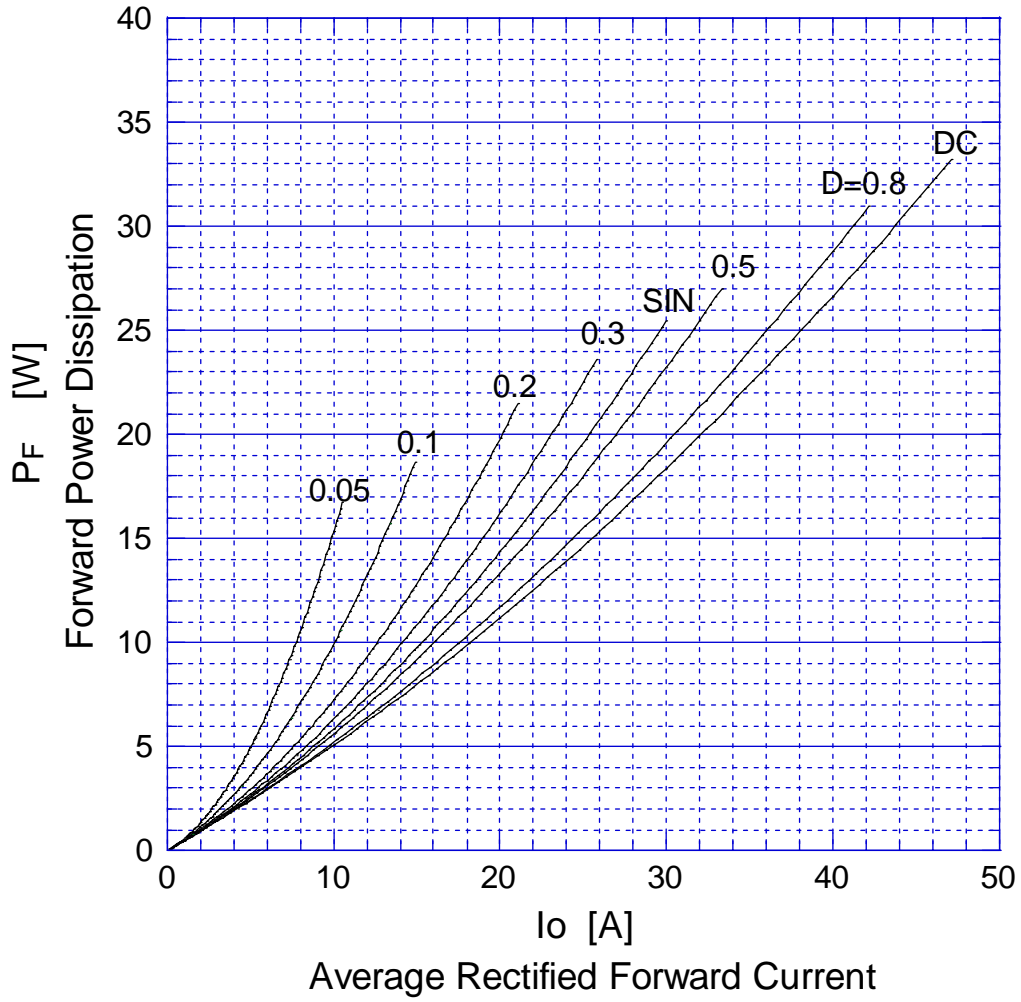

$T_j = 150^\circ\text{C}$

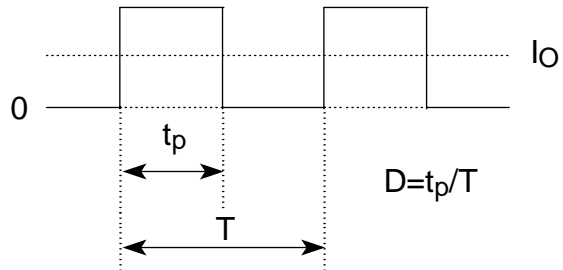

SF30JC10 Reverse Power Dissipation

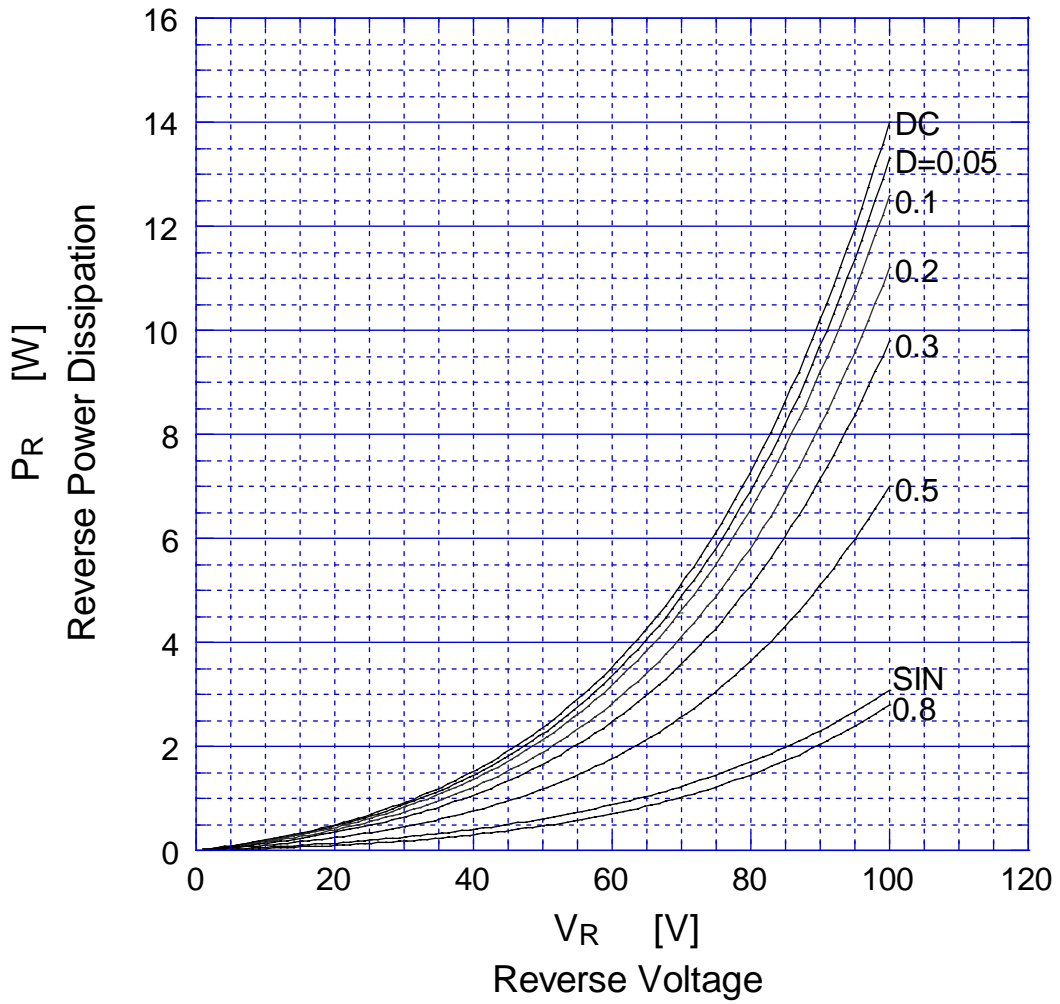

$T_j = 150^\circ\text{C}$

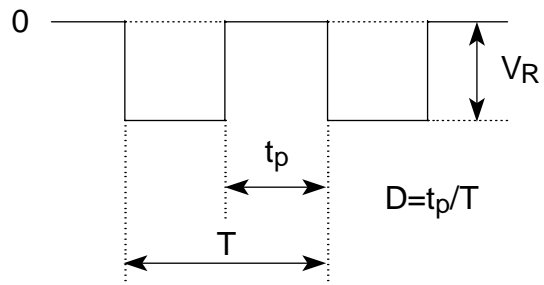

SF30JC10

Derating Curve

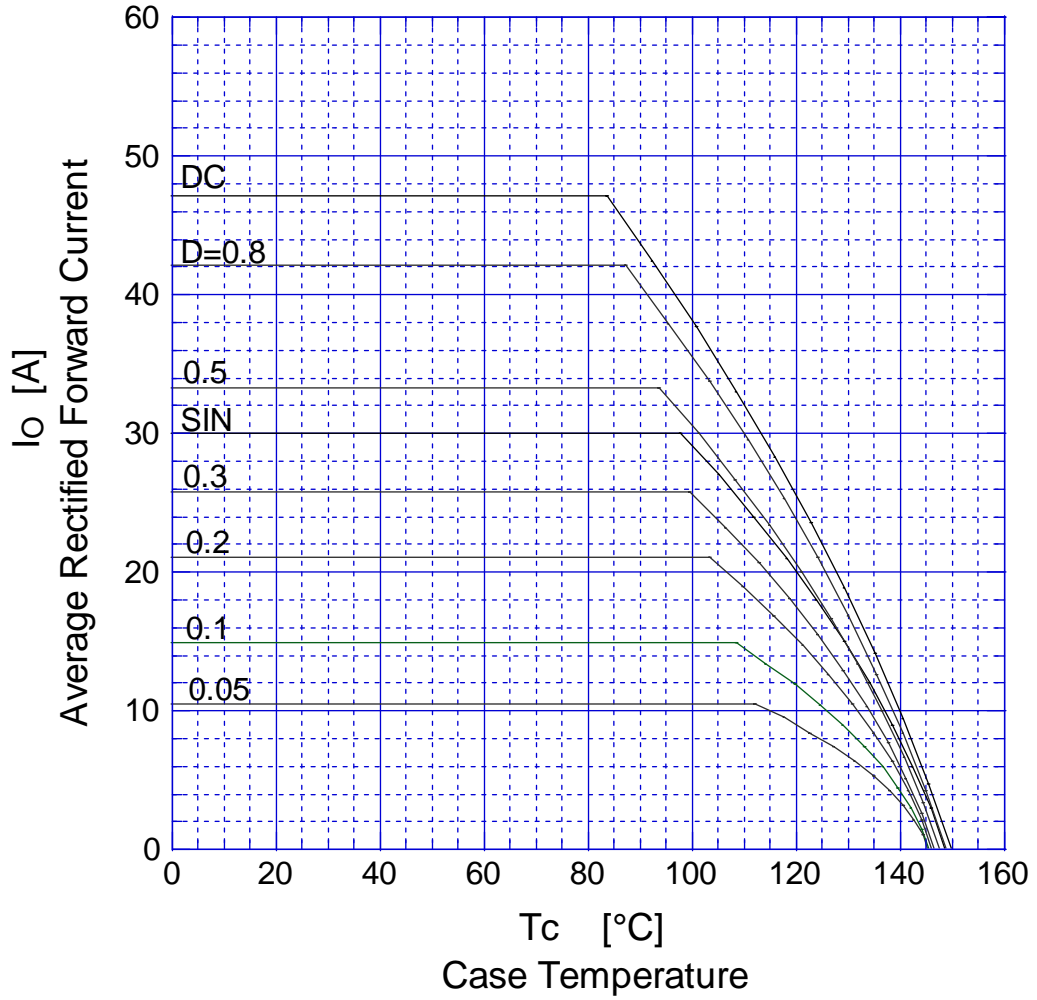

$V_R = 50V$

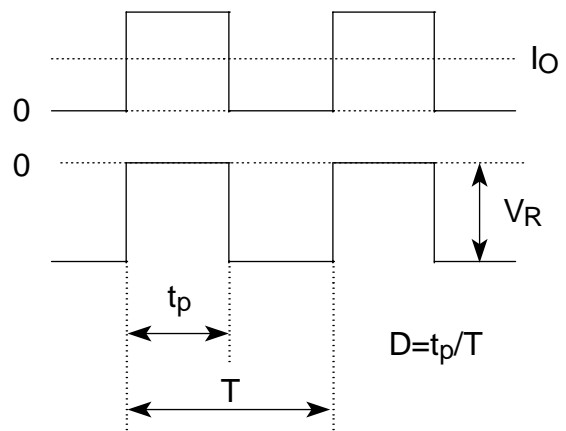

SF30JC10 Peak Surge Forward Capability

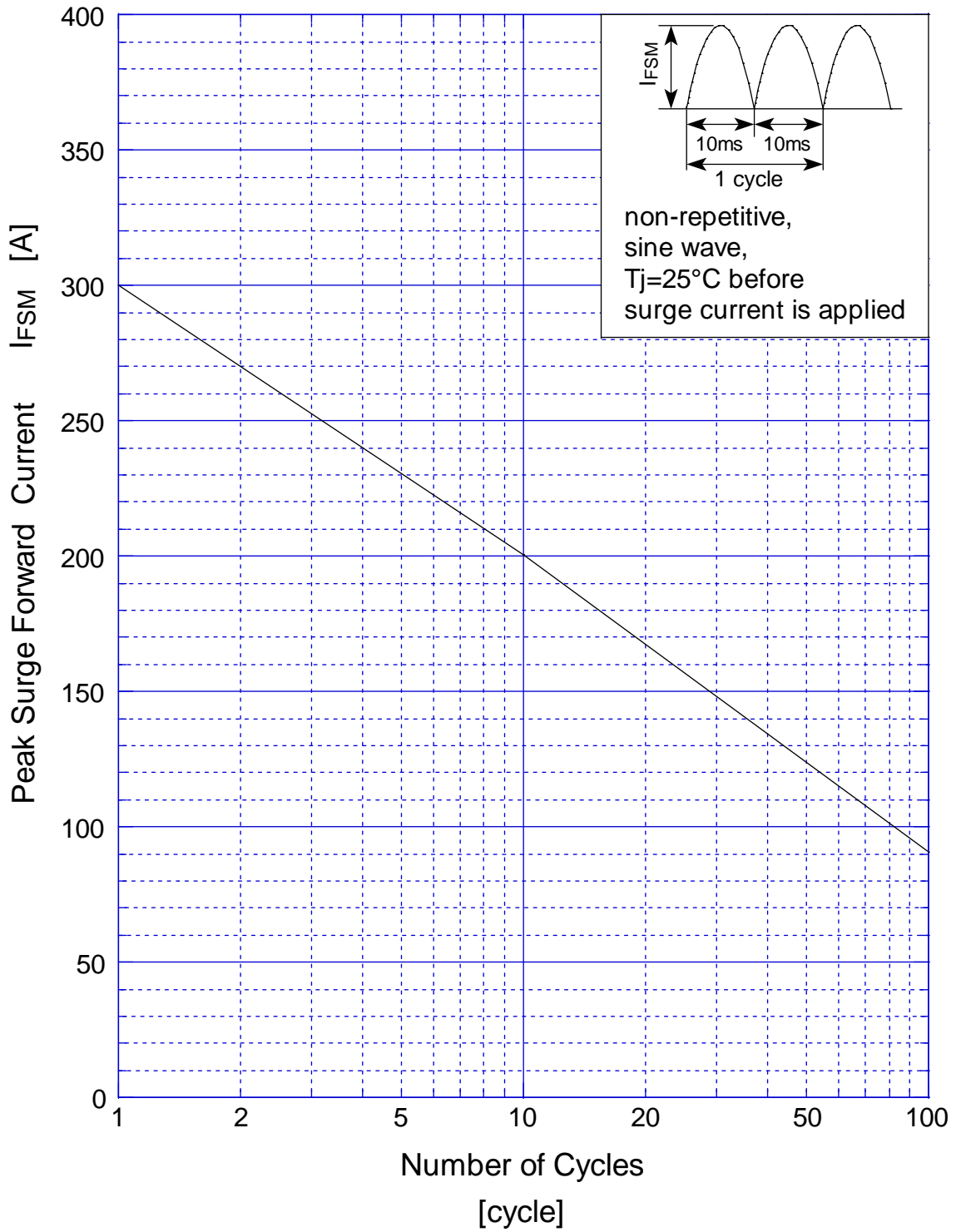

SF30JC10 Junction Capacitance

