

## I<sup>2</sup>C BUS CONTROLLED R/G/B VIDEO AMPLIFIER

The KA2506 is a very high frequency video amplifier system with I<sup>2</sup>C Bus controlled used in Monitor with high resolution up to 1280 × 1024.

It contains 3 matched R/G/B video Amplifiers with OSD interface and provides a flexible interfacing to I<sup>2</sup>C Bus controlled adjustment system.

### FUNCTIONS

- R/G/B Video Amplifier
- OSD Interface
- I<sup>2</sup>C BUS Control
- Contrast/OSD Contrast
- Brightness Control
- Cut-Off Brightness Control
- R/G/B SUB Contrast/Cut-Off Control
- Blank/Clamp Gate
- Half tone (2 OSD Raster/8 Colors)
- OSD Intensity

### FEATURES

- 3-Channel R/G/B Video Amplifier, 175MHz @f-3dB
- I<sup>2</sup>C Bus Control Items
  - Contrast Control
  - SUB Contrast Control For Each Channel
  - Brightness Control
  - OSD Contrast Control
  - Cut-off Brightness Control
  - Cut-off Control For Each Channel
  - Switch Registers for SBLK and Video Half Tone and Cut-Off INT/EXT and BPS (Blank Gate Polarity Selection)
- SUB Contrast Control Range: -11dB
- Capable of 7.0Vpp Output Swing Range
- Video/OSD High Speed Switch
- Clamp Gate With Anti OSD Sagging
- OSD Intensity
- Video Input Clamp, BRT Clamp
- Video & OSD Half Tone Function on OSD Picture (2 OSD Raster Selection by HR1, HG1, HB1, HR2, HG2, HB2: 8 colors)
- OSD Interface, OSD BLK
- ABL
- TTL R/G/B OSD Inputs, 80MHz bandwidth
- Contrast Control Range: -38dB
- OSD Contrast Control Range: -38dB

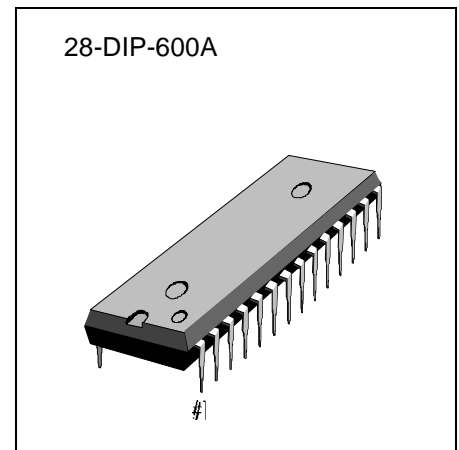

### ORDERING INFORMATION

Device	Package	Operating Temperature
KA2506	28-DIP-600A	-20 °C ~ +70 °C

BLOCK DIAGRAM

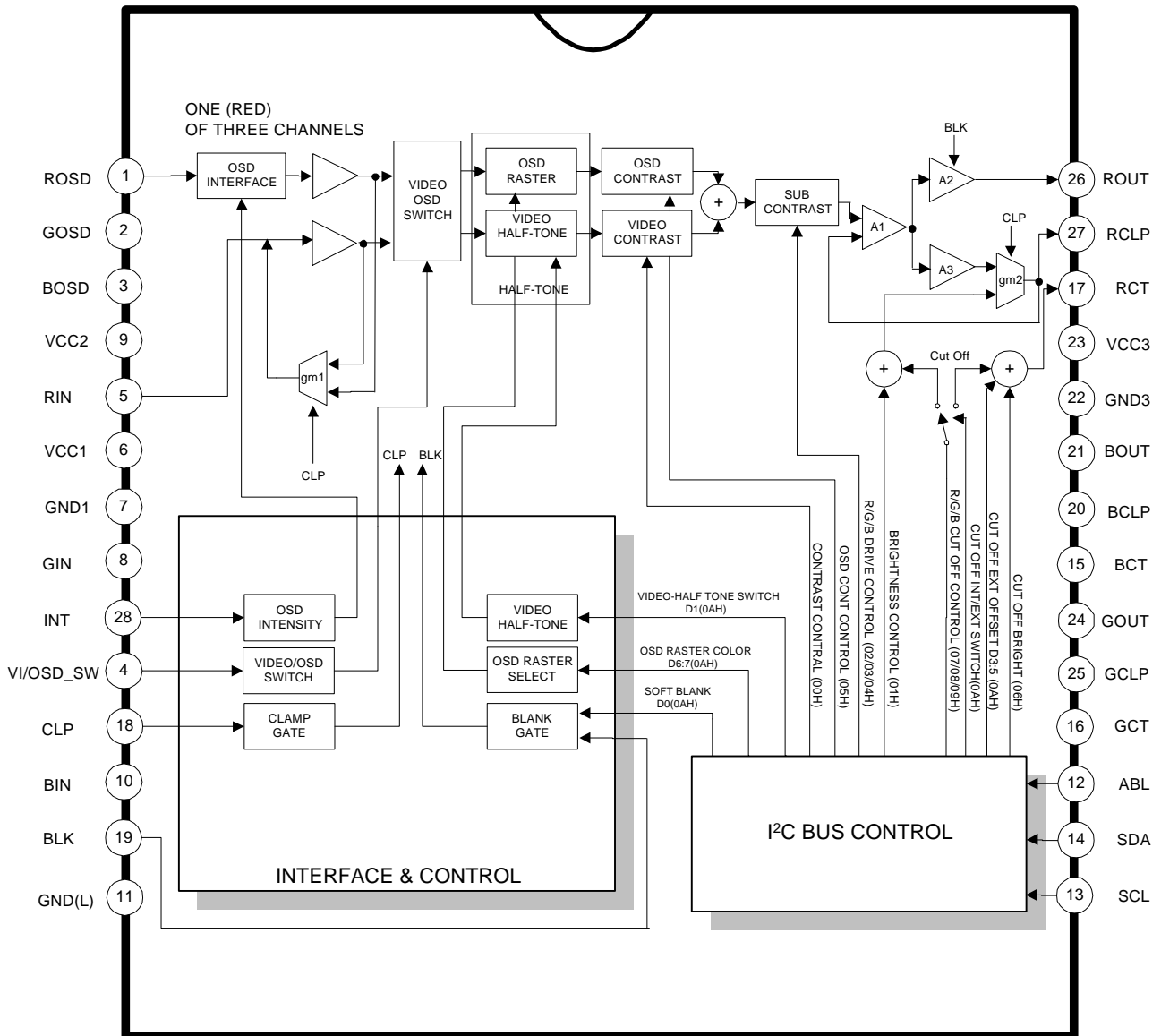

## PIN CONFIGURATIONS

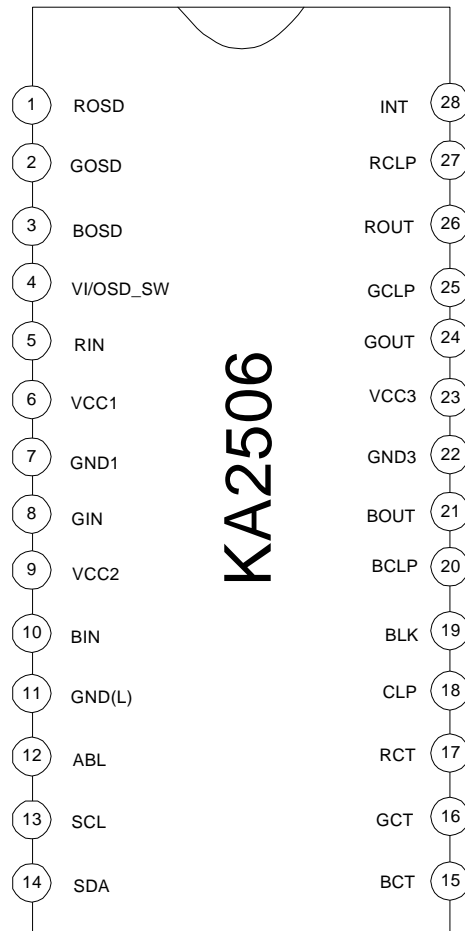

Table 1. Pin Configurations

Pin No	Symbol	I/O	Configurations
1	ROSD	I	Red OSD Input
2	GOSD	I	Green OSD Input
3	BOSD	I	Blue OSD Input
4	VI/OSD_SW	I	Video or OSD Switch
5	RIN	I	Red Video Input
6	V <sub>CC1</sub>	-	V <sub>CC</sub> (normal)
7	GND1	-	Ground1 (normal)
8	GIN	I	Green Video Input
9	V <sub>CC2</sub>	-	V <sub>CC</sub> (normal)

Table 1. Pin Configurations

Pin No	Symbol	I/O	Configurations
10	BIN	I	Blue Video Input
11	GND (L)	-	Ground2 (logic)
12	ABL	-	Automatic Beam Limit
13	SCL	I/O	Serial Clock
14	SDA	I/O	Serial Data
15	BCT	I	Blue Cut Off Control
16	GCT	I	Green Cut Off Control
17	RCT	I	Red Cut Off Control
18	CLP	I	Clamp Gate Signal Input
19	BLK	I	Blank Gate Signal Input
20	BCLP	-	Blue Clamp Cap
21	BOUT	O	Blue Video Output
22	GND3	-	Ground3 (drive part)
23	V <sub>CC3</sub>	-	V <sub>CC</sub> (drive part)
24	GOUT	O	Green Video Output
25	GCLP	-	Green Clamp Cap
26	ROUT	O	Red Video Output
27	RCLP	-	Red Clamp Cap
28	INT	I	OSD Intensity

**PIN DESCRIPTION**

**Table 2. Pin Description**

Pin No	Pin Name	Schematic	Description
1 2 3	Red OSD Input (ROSD) Green OSD Input (GOSD) Blue OSD Input (BOSD)		OSD input signals are in TTL level and will be connected to ground when switching to video input
4	Video/OSD Switch (VI/OSD_SW)		Video/OSD switch signal is TTL level OSD input = "High" Video input = "Low"
5 8 10	Red Video Input (RIN) Green Video Input (GIN) Blue Video Input (BIN)		MAX input video signal is 0.7 Vpp
6	V <sub>CC1</sub>	-	Supply voltage (except drive part)
9	V <sub>CC2</sub>	-	Supply voltage (except drive part)

Table 2. Pin Description (Continued)

Pin No	Pin Name	Schematic	Description
7	GND1	-	Ground (analogue)
11	GND2 (GND (L) )	-	Ground (logic)
15 16 17	Blue Cut-Off (BCT) Green Cut-Off (GCT) Red Cut-Off (RCT)		Cut-Off Control Output
18	Clamp Gate Input (CLP)		Video amp activates when clamp gate signal is in low TTL level. Clamp gate Min. duty f: 50kHz duty: 0.2us
19	Blank Gate Input (BLK)		Video amp blanks video signal when blank gate signal is in low TTL level.

Table 2. Pin Description (Continued)

Pin No	Pin Name	Schematic	Description
26 24 21	Red Video Output (ROUT) Green Video Output (GOUT) Blue Video Output (BOUT)		Video signal output
20 25 27	Blue Clamp Cap (BCLP) Green Clamp Cap (GCLP) Red Clamp Cap (RCLP)		Brightness controlling actives by charging and discharging of the external cap. (0.1μF) (during low clamp gate)
22	GND3	-	Ground (drive part)
23	V <sub>CC3</sub>	-	Supply voltage (drive part)
13 14	SCL SDA		Serial clock input port of I <sup>2</sup> C BUS Serial data input port of I <sup>2</sup> C BUS

Table 2. Pin Description (Continued)

Pin No	Pin Name	Schematic	Description
28	OSD Intensity Input (INT)		OSD Intensity Input
12	ABL Input (ABL)		Automatic beam limitation input (control range: 0.5 ~ 4.5V)



**ABSOLUTE MAXIMUM RATING (TA = 25 °C)<sup>(1)</sup>****Table 3. Absolute Maximum Rating**

No	Item	Symbol	Value			Unit
			Min	Typ	Max	
1	Maximum Supply Voltage	$V_{CC1/2/3}/V_{DD}$	-	-	13.2	V
2	Operating Temperature <sup>(2)</sup>	T <sub>opr</sub>	-20	-	70	°C
3	Storage Temperature	T <sub>stg</sub>	-65	-	150	°C
4	Operating Supply Voltage	V <sub>ccop</sub>	11.4	12.0	12.6	V <sup>(3)</sup>
5	Power Dissipation	P <sub>D</sub>	-	-	2.0	W

**THERMAL & ESD PARAMETER****Table 4. Thermal & ESD Parameter**

No	Item	Symbol	Value			Unit
			Min	Typ	Max	
1	Thermal Resistance (Junction-ambient)	θ <sub>ja</sub>	-	45	-	°C/W
2	Junction Temperature	T <sub>j</sub>	-	150	-	°C
3	Human Body Mode (C = 100p, R = 1.5k)	HBM	2	-	-	KV
4	Machine Model (C = 200p, R = 0)	MM	300	-	-	V
5	Charge Device Model	CDM	800	-	-	V

**ELECTRICAL CHARACTERISTICS****DC Electrical Characteristics**

T<sub>a</sub> = 25 °C, V<sub>CC1</sub> = V<sub>CC2</sub> = V<sub>CC3</sub> = 12V; V<sub>4</sub> = 0V; unless otherwise stated

**Table 5. DC Electrical Characteristics**

Parameter	Symbol	Min	Typ	Max	Unit
Supply Current	I <sub>CC</sub> <sup>(4)</sup>	85	110	135	mA
Clamp Gate Low Input Voltage	V <sub>15l</sub>	0.8	1.5	3.0	V
Clamp Gate High Input Voltage	V <sub>15h</sub>	0.8	1.5	2.0	V

Table 5. DC Electrical Characteristics(Continued)

Parameter	Symbol	Min	Typ	Max	Unit
Clamp Gate Low Input Current	$I_{15l}$	-5.0	-2.0	-	$\mu\text{A}$
Clamp Gate High Input Current	$I_{15h}$	-	0.01	1.0	$\mu\text{A}$
Blank Gate Low Input Voltage	$V_{16l}$	0.8	1.5	3.0	V
Blank Gate High Input Voltage	$V_{16h}$	0.8	1.5	2.0	V
Blank Gate Low Input Current	$I_{16l}$	-5.0	-2.0	-	$\mu\text{A}$
Blank Gate High Input Current	$I_{16h}$	-	0.01	1.0	$\mu\text{A}$
Video Input bias Voltage	$V_{\text{bias}}$	1.6	1.9	2.2	V
Output Clamp Cap Charge Current	$I_{\text{clamp+}}$	0.45	0.75	1.10	mA
Output Clamp Cap Discharge Current	$I_{\text{clamp-}}$	-1.10	-0.75	-0.45	mA
Video Output Low Voltage	$V_{\text{OL}}$	-	100	200	mV
Video Output High Voltage	$V_{\text{OH}}$	6.2	7.5	9.0	V
Video Black Level Output Voltage	$V_{\text{OBL}}$	0.9	1.2	1.5	V
Video $\Delta$ Black Level Output Voltage	$\Delta V_{\text{OBL}}^{(5)}$	-0.3	-	0.3	V
Video Output Blanked Voltage	$V_{\text{OB}}$	-	0.1	0.2	V
Contrast/Drive Control Input Current	$I_{\text{osd}}, I_{\text{drive}}$ $I_{\text{con}}$	-	0.25	1	$\mu\text{A}$
Spot Killer Voltage	$V_{\text{spot}}$	9.2	10.4	11.2	V

**AC Electrical Characteristics**

T<sub>a</sub> = 25 °C, V<sub>CC1</sub> = V<sub>CC2</sub> = V<sub>CC3</sub> = 12V; V<sub>4</sub> = 0V.

V<sub>in</sub> = 0.56V<sub>pp</sub> Manually adjust Video Output pins 21, 24 and 26 to 4V DC for the AC test <sup>(11)</sup> unless otherwise stated <sup>(12)</sup>

**Table 6. AC Electrical Characteristics**

Parameter	Symbol	Min	Typ	Max	Unit
Video Amplifier Gain	A <sub>V</sub> max	15.5	17.5	19.5	dB
Contrast Attenuation 1	A <sub>vc1</sub>	-4.5	-6.0	-7.5	dB
Contrast Attenuation 2	A <sub>vc2</sub>	-	-38	-35	dB
Drive Attenuation1	A <sub>vd1</sub>	-3	-4	-5	dB
Drive Attenuation 2	A <sub>vd2</sub>	-11	-8	-5	dB
Absolute Gain Match	A <sub>V</sub> match <sup>(6)</sup>	-1	-	1	dB
Gain Change between Amplifiers	A <sub>V</sub> track <sup>(7)</sup>	-1	-	1	dB
Video Amplifier Distortion	THD	-	1	5	%
Video Amp Bandwidth <sup>(7,8)</sup>	f (-3dB)	150	175	-	MHz
Video Output Rise Time <sup>(7)</sup>	t <sub>r</sub> (Video)	-	2.0	2.3	ns
Video Output Fall Time <sup>(7)</sup>	t <sub>f</sub> (Video)	-	2.5	2.8	ns
Video Amplifier 10kHz Isolation	Viso_10K <sup>(9)</sup>	-	-65	-45	dB
Video Amplifier 10MHz Isolation	Viso_10M <sup>(7,9)</sup>	-	-50	-35	dB
Blank Output Rise Time <sup>(7)</sup>	t <sub>r</sub> (Blank)	-	6	15	ns
Blank Output Fall Time <sup>(7)</sup>	t <sub>f</sub> (Blank)	-	10	30	ns
End of Blanking Propagation Delay	t <sub>r-prop</sub> (Blank)	-	23	50	ns
Start of Blanking Propagation Delay	t <sub>f-prop</sub> (Blank)	-	20	45	ns

**OSD Electrical Characteristics**

T<sub>a</sub> = 25 °C, V<sub>CC1</sub> = V<sub>CC2</sub> = V<sub>CC3</sub> = 12V; V<sub>19</sub> = 4V; V<sub>12</sub> = V<sub>28</sub> = 0V;

V<sub>1</sub> = V<sub>2</sub> = V<sub>3</sub> = 4V; V<sub>4</sub> = 4V; unless otherwise stated

**Table 7. OSD Electrical Characteristics**

Parameter	Symbol	Min	Typ	Max	Unit
OSD Input Low Input Voltage	V <sub>OSDI</sub>	0.4	1.3	3.0	V

Table 7. OSD Electrical Characteristics(Continued)

Parameter	Symbol	Min	Typ	Max	Unit
OSD Input High Input Voltage	$V_{OSDh}$	0.4	0.8	1.2	V
OSD Select Low Input Voltage	$V_{4l}$	0.8	1.6	3.0	V
OSD Select High Input Voltage	$V_{4h}$	0.8	1.6	2.0	V
OSD Select Low Input Current	$I_{4l}$	-10	-5	-	$\mu$ A
OSD Select High Input Current	$I_{4h}$	70	100	130	$\mu$ A
OSD Output Black Level	$V_{BLV-OSD}$	-	0.1	0.2	V
OSD Output Voltage	$V_{OSD}$	2.6	3.6	4.6	$V_{PP}$
OSD Output Vpp Attenuation	$V_{OSD\_ATT}$	30	50	70	%
OSD Intensity Attenuation	$V_{INT\_ATT}$	30	50	70	%
Output Match between Channels	$V_{OSD}$	-7	-	7	%
Video to OSD Switch Time <sup>(7)</sup>	$t_r$ (OSD S)	-	4	10	ns
OSD to Video Switch Time <sup>(7)</sup>	$t_f$ (OSD S)	-	11	20	ns
Video to OSD Propagation Delay	$t_{r-pr}$ (OSD S)	-	11	25	ns
OSD to Video Propagation Delay	$t_{f-pr}$ (OSD S)	-	12	25	ns
OSD Rising Time	$t_r$ (OSD)	-	4	8	ns
OSD Falling Time	$t_f$ (OSD)	-	5	10	ns
OSD Rising Propagation Delay	$t_{r-pr}$ (OSD)	-	7	15	ns
OSD Falling Propagation Delay	$t_{f-pr}$ (OSD)	-	9	20	ns
Video/OSD 10kHz Isolation	liso10K (OSD)	-	-60	-40	dB
Video/OSD 10MHz Isolation	liso10M (OSD)	-	-50	-35	dB

I<sup>2</sup>C BUS Recommended Operating ConditionsTable 8. I<sup>2</sup>C BUS Recommended Operating Conditions

Parameter	Symbol	Min	Typ	Max	Unit
Input High Level Voltage	V <sub>inH</sub>	3.0	-	-	V
Input Low Level Voltage	V <sub>inL</sub>	-	-	1.5	V
SCL Clock Frequency	f <sub>SCL</sub>	-	-	200	kHz
Hold Time Before a new transmission can start	t <sub>BUF</sub>	1.3	-	-	μs
Hold Time for Start Condition	t <sub>HDS</sub>	0.6	-	-	μs
Set-up Time for Stop Conditions	t <sub>SUP</sub>	0.6	-	-	μs
The Low Period of SCL	t <sub>LOW</sub>	1.3	-	-	μs
The High Period of SCL	t <sub>HIGH</sub>	0.6	-	-	μs
Hold Time Data	t <sub>HDATA</sub>	0.3	-	-	μs
Set-up Time Data	t <sub>SUPDAT</sub>	0.25	-	-	μs
Rise Time of SCL	t <sub>R</sub>	-	-	1.0	μs
Fall Time of SCL	t <sub>F</sub>	-	-	3.0	μs

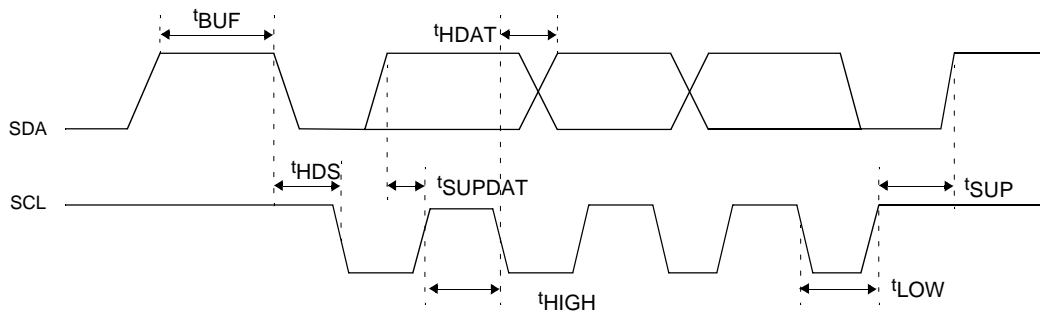
I<sup>2</sup>C BUS Timing Requirement

**NOTES;**

1. Absolute Maximum Rating Indicates limit beyond which damage to the device may occur.
2. Operating Ratings indicate conditions for which the device is functional but do not guarantee specific performance limits. For guaranteed specifications and test conditions, See the Electrical Characteristics. The guaranteed specifications apply only for the test conditions listed. Some performance characteristics may degrade when the device is not operated under the listed test conditions.
3. V<sub>CC</sub> supply pins 6, 9, and 23 must be externally wired to gether to prevent internal damage during V<sub>CC</sub> power on/off cycles.
4. The supply current specified is the quiescent current for V<sub>CC1</sub>/V<sub>CC2</sub> and V<sub>CC3</sub> with R<sub>L</sub> = ∞ , The supply current for V<sub>CC3</sub> (pin 23) also depends on the output load.
5. Output voltage is dependent on load resistor. Test circuit uses R<sub>L</sub> = 39Ω
6. Measure gain difference between any two amplifiers V<sub>in</sub> = 560mVpp.
7. When measuring video amplifier bandwidth or pulse rise and fall times, a double sided full ground plane printed circuit board without socket is recommended. Video amplifier 10MHz isolation test also requires this printed circuit board. The reason for a double sided full ground plane PCB is that large measurement variations occur in single sided PCBs.
8. Adjust input frequency from 10MHz (AV max reference level) to the -3dB frequency (f<sub>-3dB</sub>).
9. Measure output levels of the other two undriven amplifiers relative to the driven amplifier to determine channel separation. Terminate the undriven amplifier inputs to simulate generator loading. Repeat test at f<sub>in</sub> = 10MHz for Iso\_10MHz.
10. A minimum pulse width of 200 ns is guaranteed for a horizontal line of 15kHz. This limit is guaranteed by design. if a lower line rate is used a longer clamp pulse may be required.
11. During the AC test the 4V DC level is the center voltage of the AC output signal. For example. if the output is 4Vpp the signal will swing between 2V DC and 6V DC.
12. These parameters are not tested on each product which is controlled by an internal qualification procedure.

## FUNCTIONAL DESCRIPTION

### Contrast (OSD Contrast Adjustment) (8-bits)

The contrast adjustment is made by controlling simultaneously the gain of three internal variable gain amplifiers through the I<sup>2</sup>C bus interface.

The contrast adjustment allows to cover a typical range of 38dB.

### Brightness Adjustment (8-bits)

The brightness adjustment controls to add the same black level (pedestal) to the 3-channel/R/G/B signals after contrast amplifier by I<sup>2</sup>C BUS.

### Cut-Off Brightness Adjustments (8-bits)

The Cut-Off Brightness adjustment is made by controlling simultaneously external cut-off current.

### Cut-Off(SUB Contrast) Adjustment (8-bits` 3)

These adjustments are used to adjust the white balance, and the gain of each channel is controlled by I<sup>2</sup>C BUS. The SUB contrast adjustment allows to cover a typical range of 11dB.

### OSD Inputs

The KA2506 includes all the circuitry necessary to mix OSD signals into the R/G/B video signal. In order to this function needs 4 pins. (R/G/B OSD, OSD blanking)

### Serial Interface

The 2-wires serial interface is an I<sup>2</sup>C BUS interface.

The slave address of the KA2506 is DC (in hexadecimal)

Bit8	Bit7	Bit6	Bit5	Bit4	Bit3	Bit2	Bit1
1	1	0	1	1	1	0	0 (W)

### Data Transfer

All bytes are sent MSB (Most Significant Bit) bit first and the write data transfer is closed by a stop.

The MCU can write data into the KA2506 registers. To do that, after a start, the MCU must send:

- The I<sup>2</sup>C address slave byte with a low level for R/W bit (bit1)
- The byte of the internal register address where the MCU wants to write data (SUB Address)
- The data
- Stop

### I<sup>2</sup>C BUS Write Operation

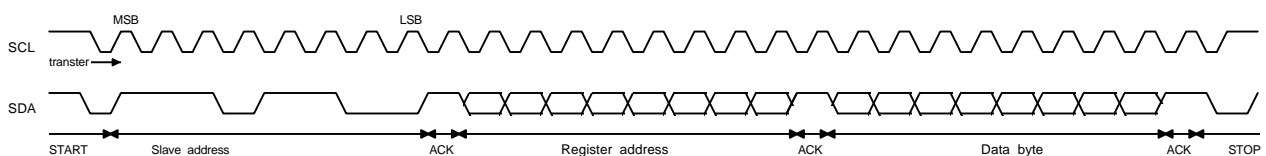

## Register Description

Register Sub Address (Slave address: DCH)

Sub Address (Hex)	Function								Int. value (Hex)	DAC bits
	D7	D6	D5	D4	D3	D2	D1	D0		
00	Contrast control								80	8 bit
01	Brightness control (3-ch)								40	8 bit
02	SUB Contrast control (R)								80	8 bit
03	SUB Contrast control (G)								80	8 bit
04	SUB Contrast control (B)								80	8 bit
05	OSD Contrast control								80	8 bit
06	Cut-off Brightness control								80	8 bit
07	Cut-off control (R)								80	8 bit
08	Cut-off control (G)								80	8 bit
09	Cut-off control (B)								80	8 bit
0A	-	HT	HR2	HG2	HB2	HR1	HG1	HB1	00	-
0B	-	-	CS3	CS2	CS1	CT	BPS	SBLK	00	-

HT: Video Half Tone ctrl switch (1: ON, 0: OFF)

HR/HG/HB: OSD Raster Color Switch for Video&OSD Half Tone

OSD Raster1			Half Tone	OSD Raster2			Half Tone
HR1	HG1	HB1		HR2	HG2	HB2	
0	0	0	Black (Int.)	0	0	0	Black (Int.)
0	0	1	Blue	0	0	1	Blue
0	1	0	Green	0	1	0	Green
0	1	1	Cyan	0	1	1	Cyan
1	0	0	Red	1	0	0	Red
1	0	1	Magenta	1	0	1	Magenta
1	1	0	Yellow	1	1	0	Yellow
1	1	1	White	1	1	1	White

CT: Cut-off Control INT/EXT (0: INT/1: EXT) select switch (DC/AC mode)

CS1/CS2/CS3/: 80/160/320uA Cut-Off ctrl EXT offset current switch (CT = 1)

SBLK: Soft Blanking switch (1: ON, 0: OFF)

BPS: Blanking Input Polarity Selection(1: Pos, 0: Neg)



**Contrast Register (SUB ADRS: 00H) (Vin = 0.56Vpp, bright: 40H, subcont: FFH)**

Hex	B7	B6	B5	B4	B3	B2	B1	B0	Contrast (Vpp)	Gain (dB)	Int. value (Hex)
00	0	0	0	0	0	0	0	0	0	-30.0	
80	1	0	0	0	0	0	0	0	1.12	11.5	0
FF	1	1	1	1	1	1	1	1	4.2	17.5	
Increment/bit									0.0164		

**Brightness Register (3-ch) (SUB ADRS: 01H) (cont: 40H, subcont: FFH)**

Hex	B7	B6	B5	B4	B3	B2	B1	B0	Brightness	Int. value (Hex)
00	0	0	0	0	0	0	0	0	0	
40	0	1	0	0	0	0	0	0	1	0
FF	1	1	1	1	1	1	1	1	4	
Increment/bit									0.0156	

**SUB Contrast Register (R/G/B-ch) (SUB ADRS: 02/03/04H)**

(Vin=0.56Vpp, bright: 40H, cont: FFH)

Hex	B7	B6	B5	B4	B3	B2	B1	B0	SUB Contrast (Vpp)	Gain (dB)	Int. value (Hex)
00	0	0	0	0	0	0	0	0	1.33	7.5	
80	1	0	0	0	0	0	0	0	2.65	13.5	0
FF	1	1	1	1	1	1	1	1	4.2	17.5	
Increment/bit									0.0123		

**OSD Contrast Register (SUB ADRS: 05H) (VOSD = TTL, bright: 40H, subcont: FFH)**

Hex	B7	B6	B5	B4	B3	B2	B1	B0	OSD Contrast (Vpp)	Gain (dB)	Int. value (Hex)
00	0	0	0	0	0	0	0	0	0	-	
80	1	0	0	0	0	0	0	0	3.7	-	0
FF	1	1	1	1	1	1	1	1	3.5	-	
Increment/bit									0.0289		

**Cut-Off Brightness Register (3-ch) (SUB ADRS: 06H)**

Hex	B7	B6	B5	B4	B3	B2	B1	B0	Cut-Off Brightness (uA)	Int. value (Hex)
00	0	0	0	0	0	0	0	0	0	
80	1	0	0	0	0	0	0	0	75	0
FF	1	1	1	1	1	1	1	1	150	
Increment/bit									0.588u	

**Cut-Off Register (R/G/B-ch) (SUB ADRS: 07/08/09H)****(cont = 80H, subcont: FFH, INT: CT=0, EXT: CT=1)**

Hex	B7	B6	B5	B4	B3	B2	B1	B0	Cut-Off INT (V)	Cut-Off EXT(mA)	Int. value (Hex)
00	0	0	0	0	0	0	0	0	-0.5	0	
80	1	0	0	0	0	0	0	0	0	250	0
FF	1	1	1	1	1	1	1	1	0.5	500	
Increment/bit									3.9m	1.96u	

APPLICATION BOARD CIRCUIT

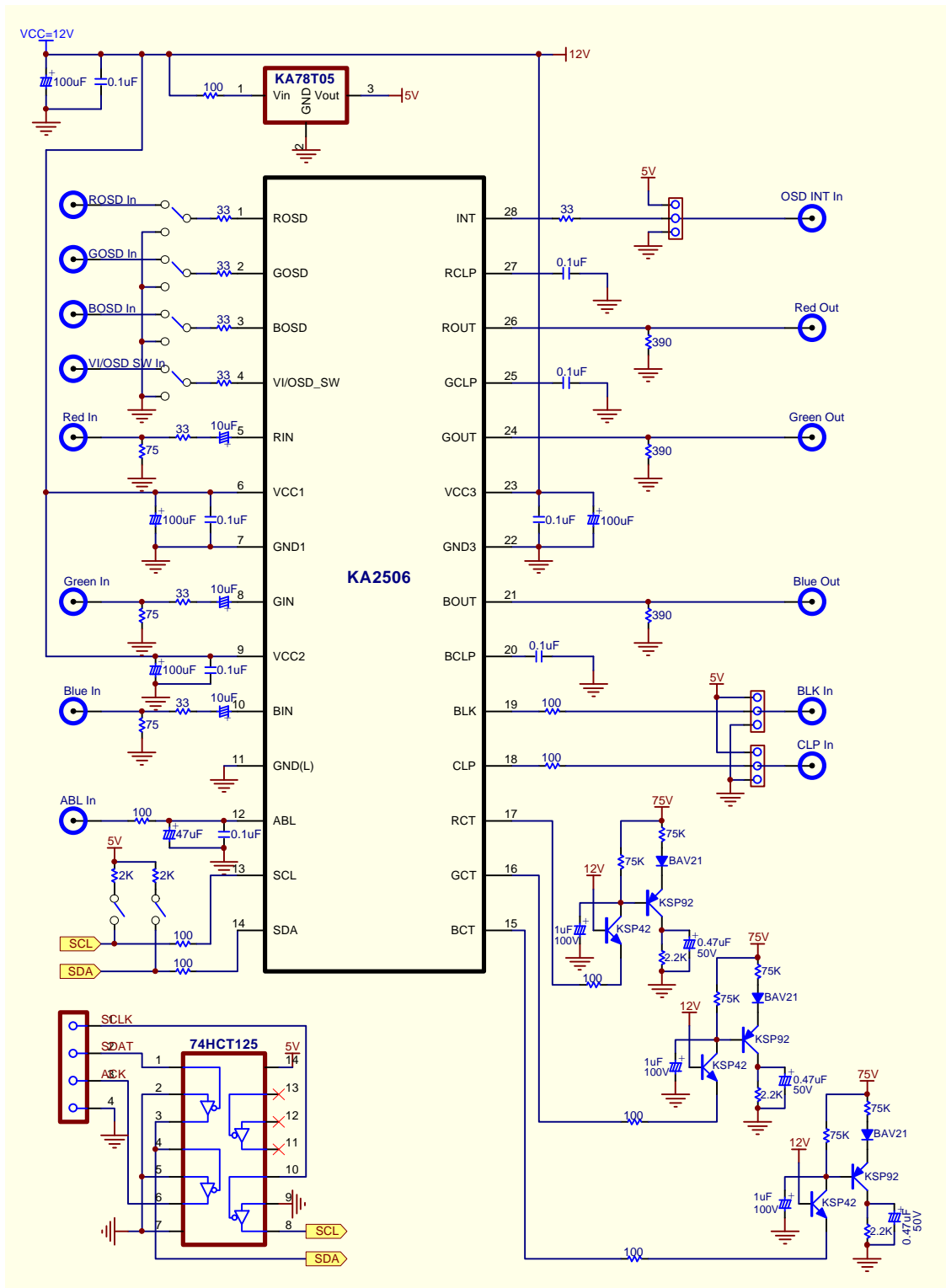

APPLICATION CIRCUIT

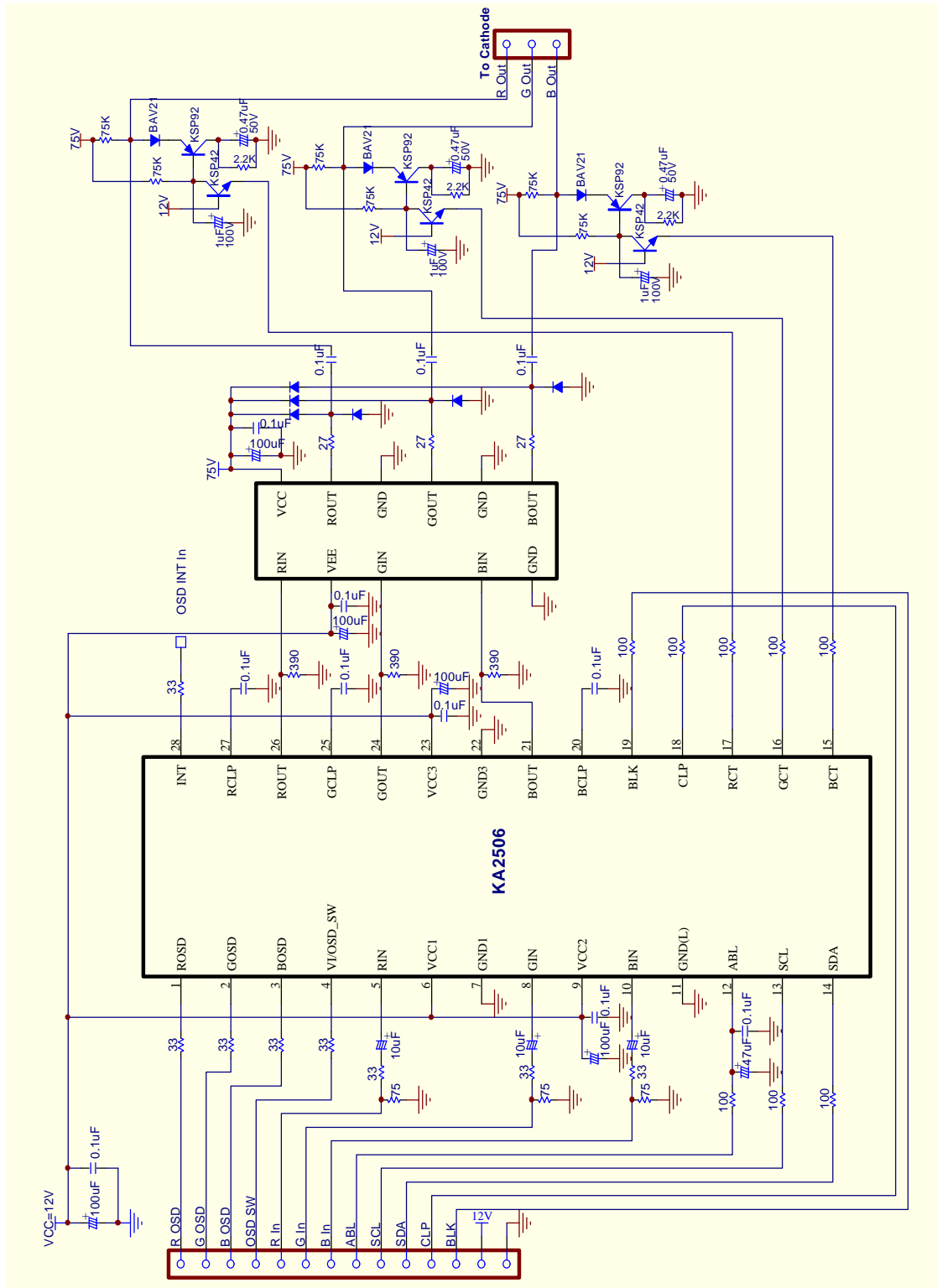

CHARACTERISTICS CURVE

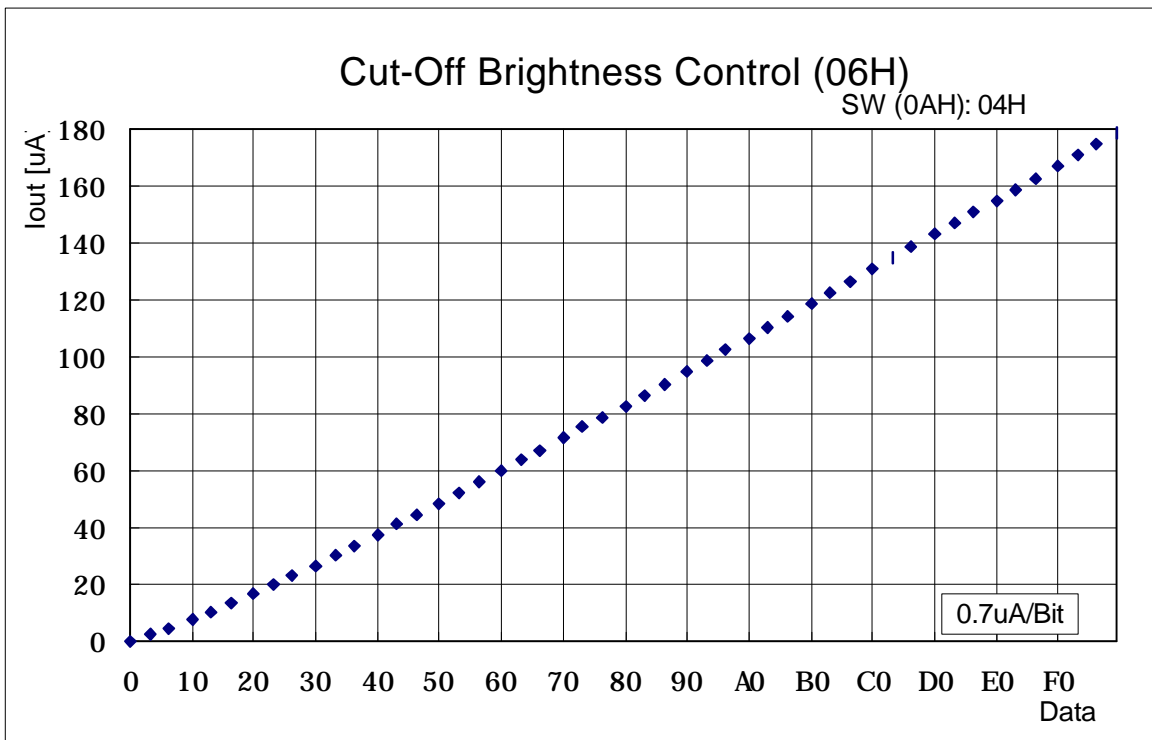
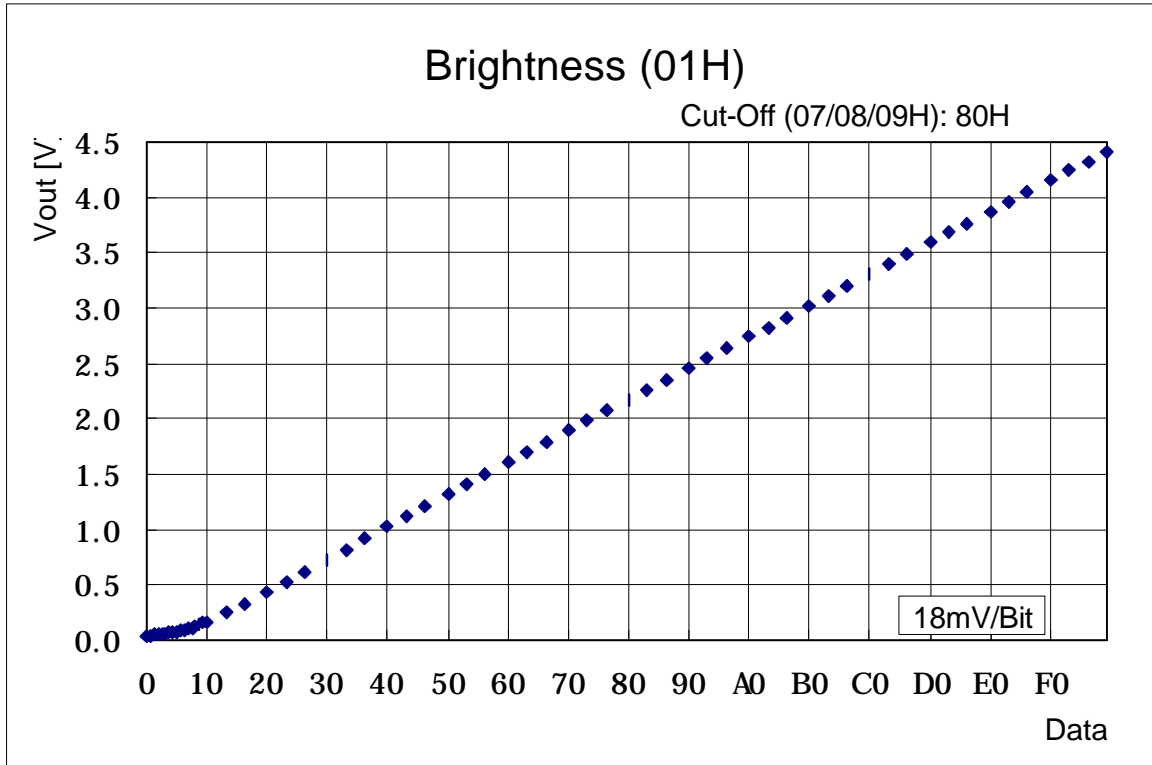

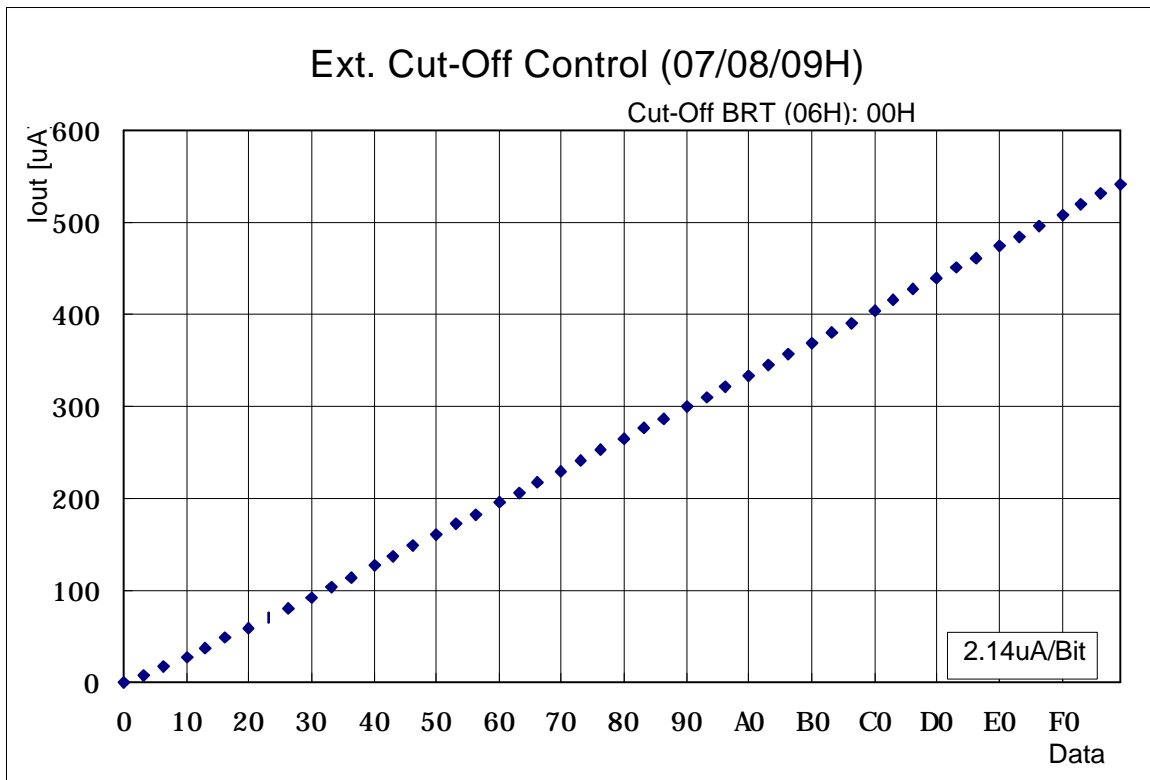
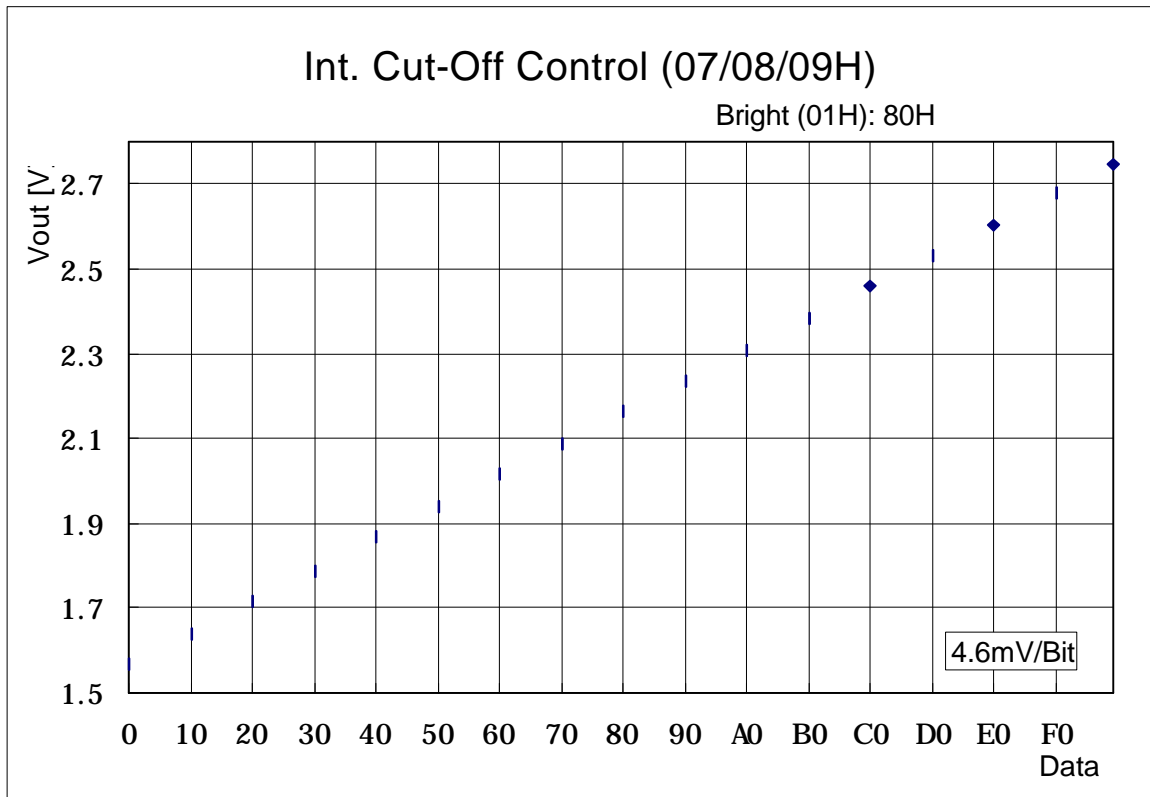

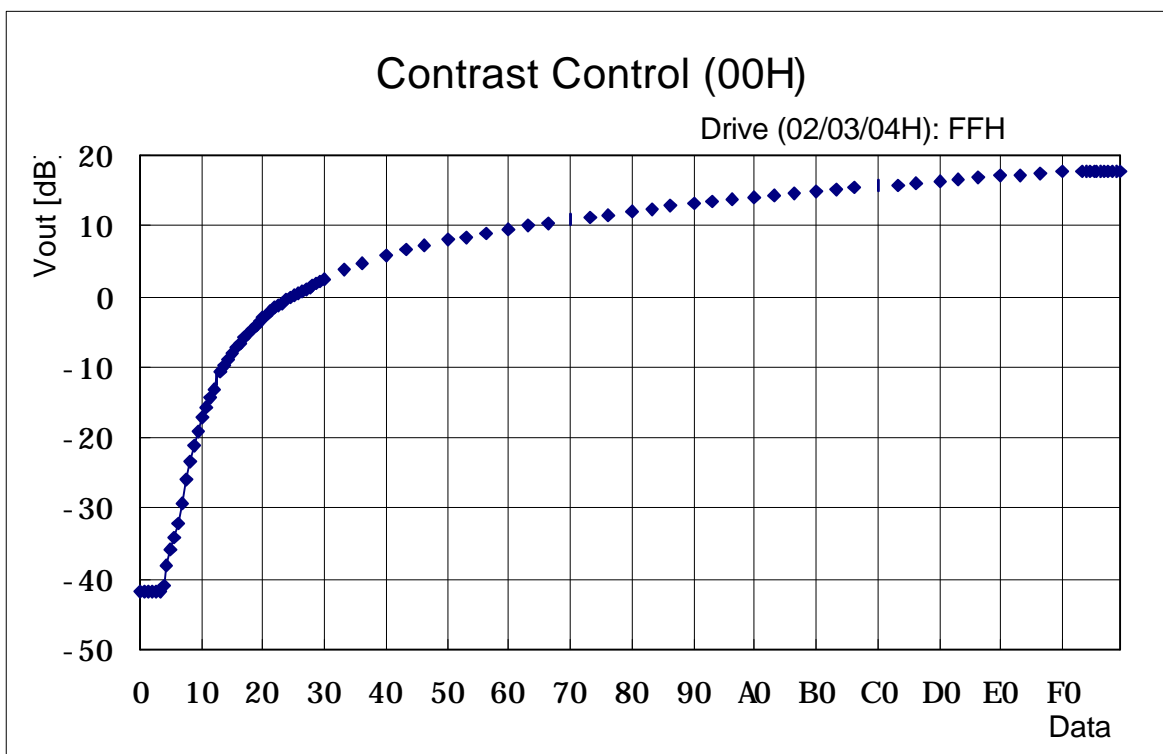
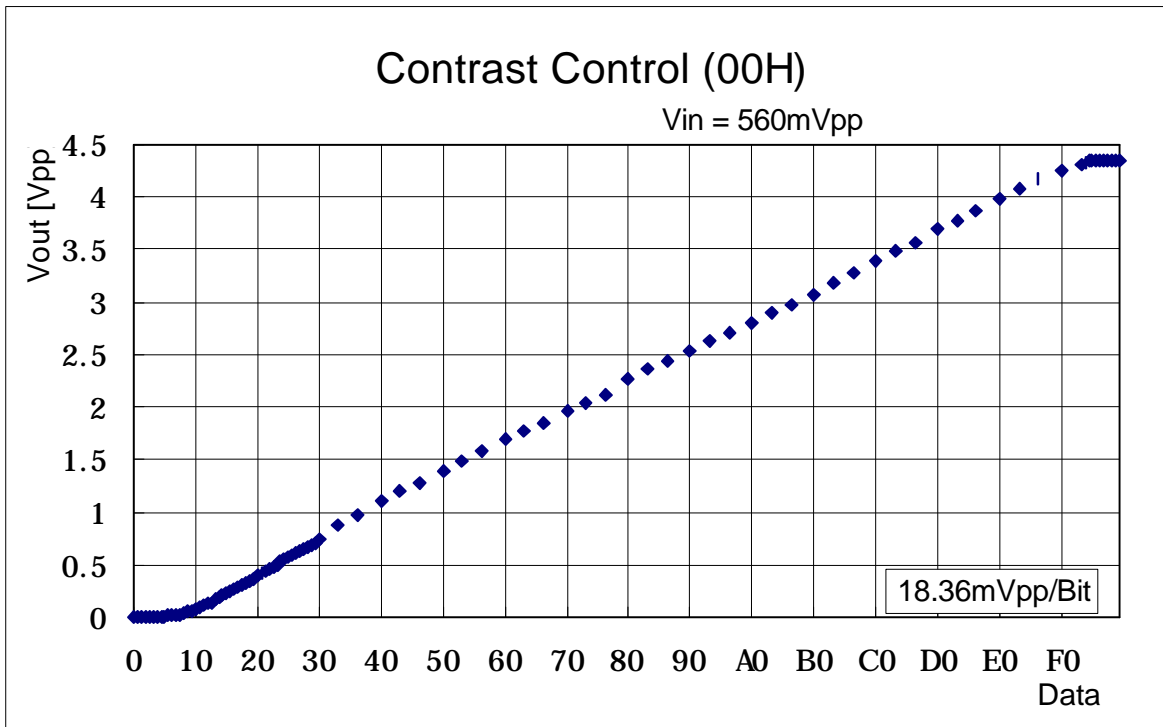

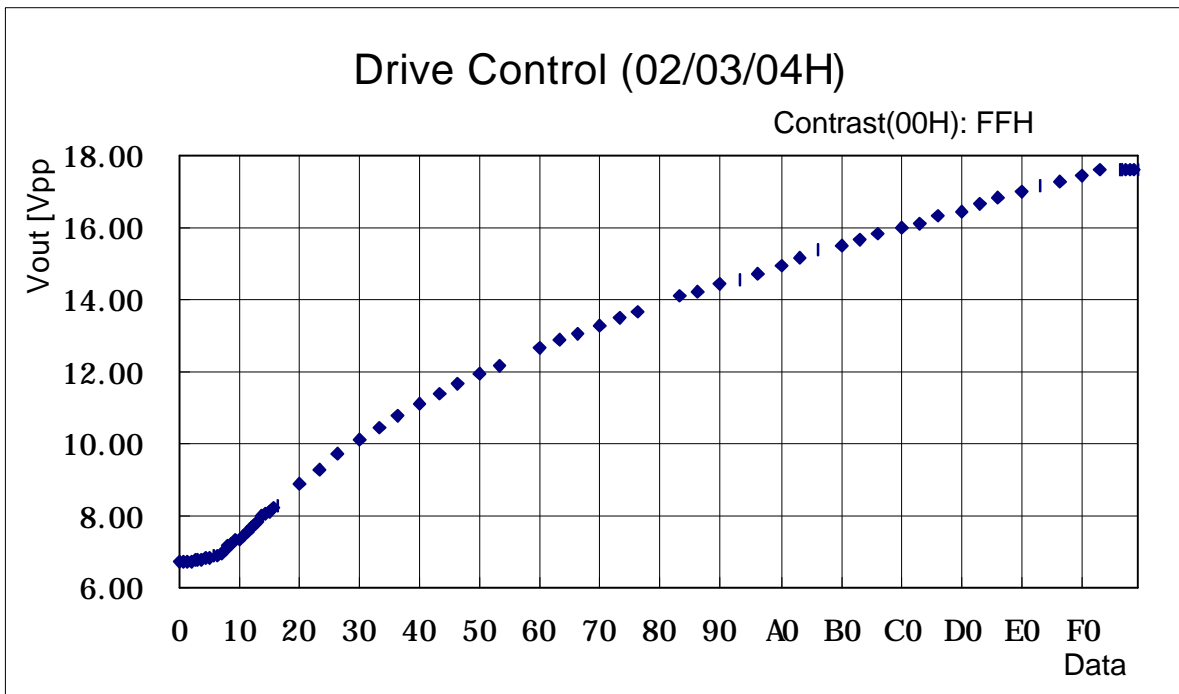
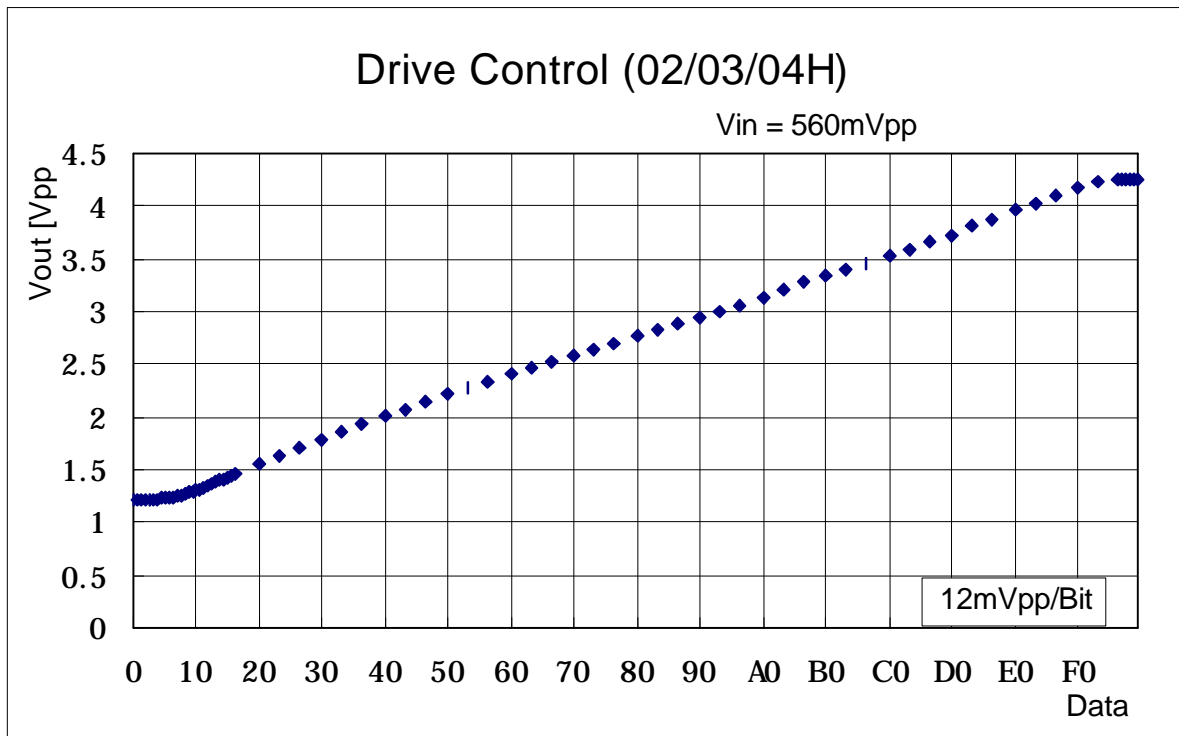



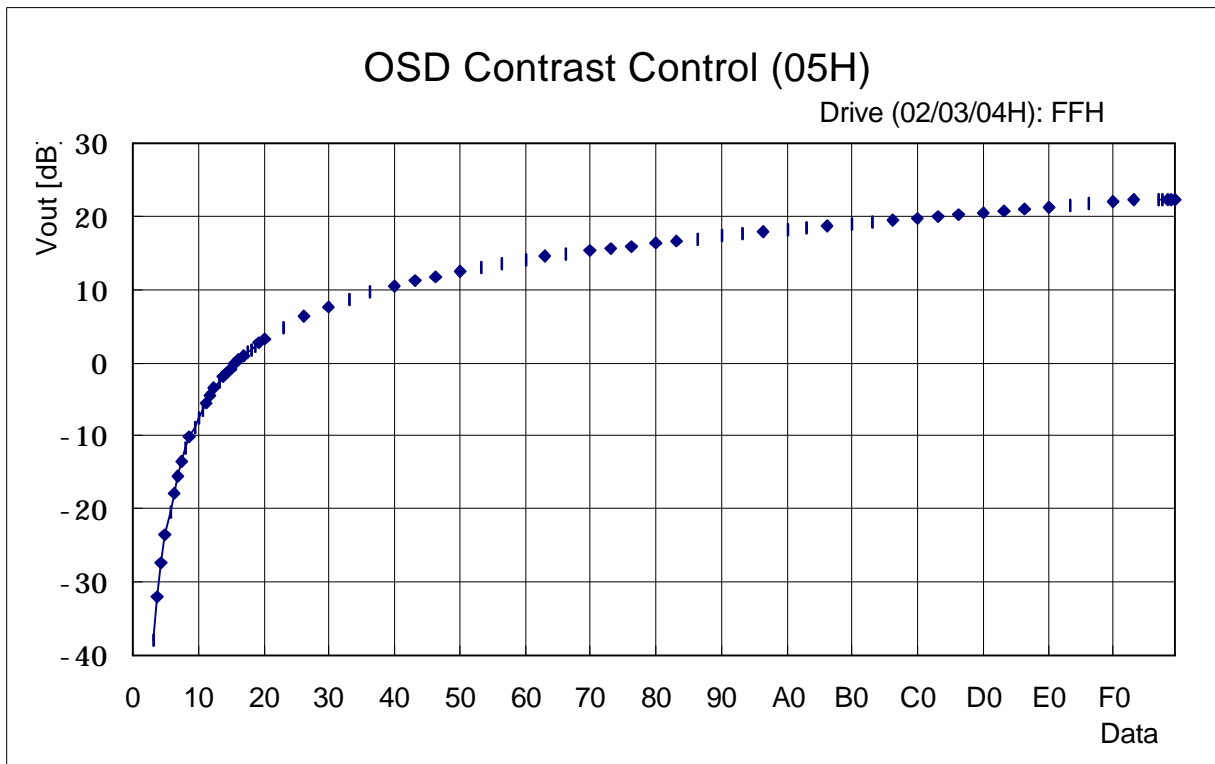
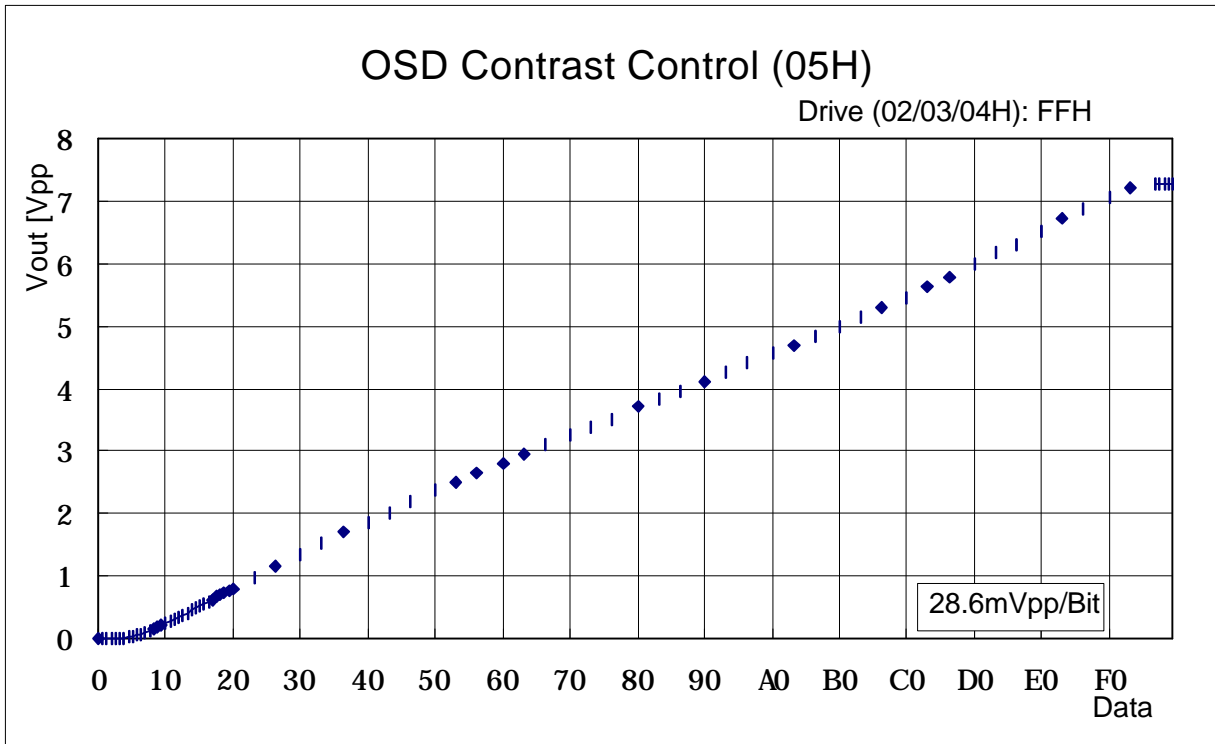

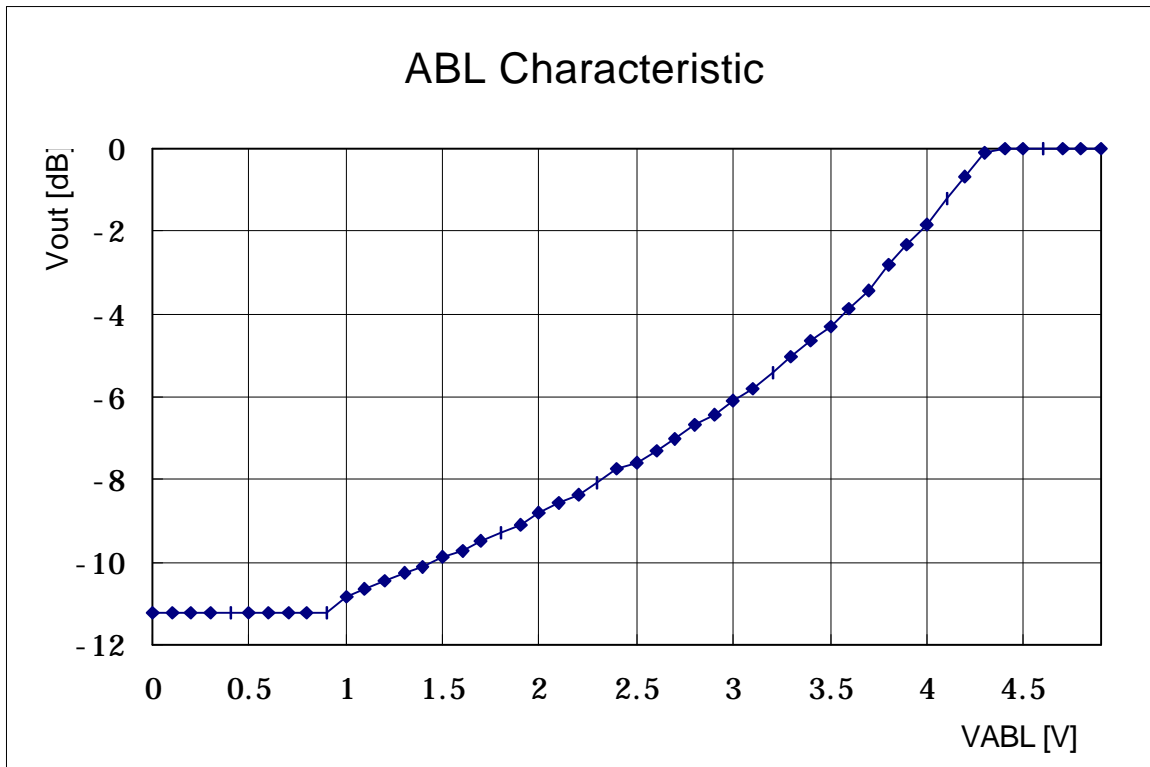

# 28-DIP-600A

Dimensions in Millimeters/inches

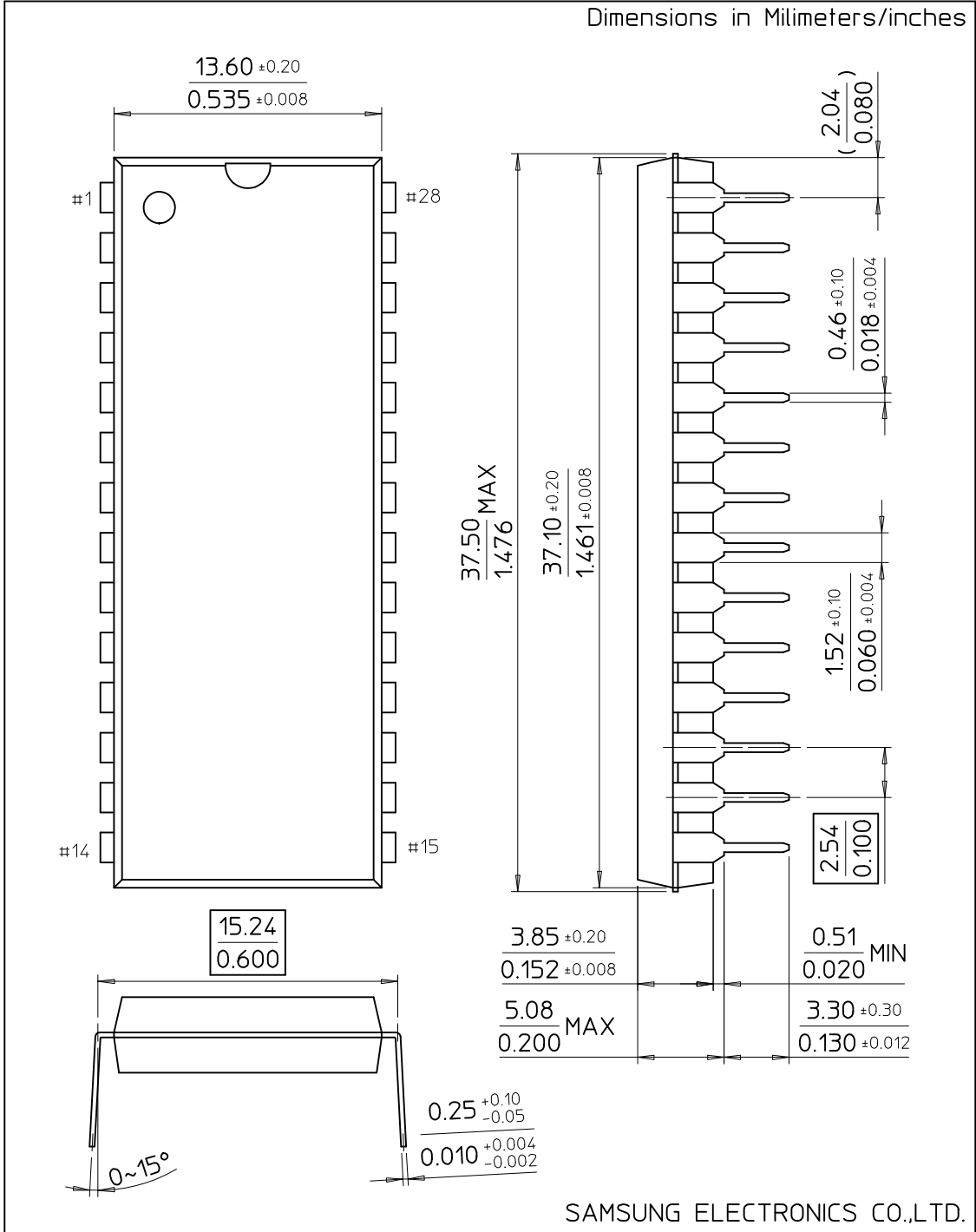

SAMSUNG ELECTRONICS CO.,LTD.