

STANDARD RECOVERY DIODES

Hockey Puk Version

Features

- Wide current range
- High voltage ratings up to 3200V
- High surge current capabilities
- Diffused junction
- Hockey Puk version
- Case style DO-200AA

Typical Applications

- Converters
- Power supplies
- Machine tool controls
- High power drives
- Medium traction applications

650A

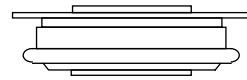

case style DO-200AA

Major Ratings and Characteristics

Parameters	SD300C..C		Units
	04 to 20	25 to 32	
$I_{F(AV)}$	650	540	A
@ T_{hs}	55	55	°C
$I_{F(RMS)}$	1150	995	A
@ T_{hs}	25	25	°C
I_{FSM}	@ 50Hz	6050	A
	@ 60Hz	6335	A
I^2t	@ 50Hz	183	KA ² s
	@ 60Hz	167	KA ² s
V_{RRM} range	400 to 2000	2500 to 3200	V
T_J	- 40 to 180	- 40 to 150	°C

SD300C..C Series

Bulletin I2083 rev. C 04/00

International
IRF Rectifier

ELECTRICAL SPECIFICATIONS

Voltage Ratings

Type number	Voltage Code	V_{RRM} , maximum repetitive peak reverse voltage V	V_{RSM} , maximum non-repetitive peak rev. voltage V	I_{RRM} max. @ $T_J = T_J$ max. mA
SD300C..C	04	400	500	15
	08	800	900	
	12	1200	1300	
	16	1600	1700	
	20	2000	2100	
	25	2500	2600	
	28	2800	2900	
	32	3200	3300	

Forward Conduction

Parameter	SD300C..C		Units	Conditions		
	04 to 20	25 to 32				
$I_{F(AV)}$ Max. average forward current @ Heatsink temperature	650(380)	540(250)	A	180° conduction, half sine wave		
	55(65)	55(85)	°C	Double side (single side) cooled		
$I_{F(RMS)}$ Max. RMS forward current	1150	995	A	@ 25°C heatsink temperature double side cooled		
I_{FSM} Max. peak, one-cycle forward, non-repetitive surge current	6050	6050	A	t = 10ms	No voltage	Sinusoidal halfwave, Initial $T_J = T_J$ max.
	6335	6335		t = 8.3ms	reapplied	
	5090	5090		t = 10ms	100% V_{RRM}	
	5330	5330		t = 8.3ms	reapplied	
I^2t Maximum I^2t for fusing	183	183	KA ² s	t = 10ms	No voltage	
	167	167		t = 8.3ms	reapplied	
	129	129		t = 10ms	100% V_{RRM}	
	118	118		t = 8.3ms	reapplied	
$I^2\sqrt{t}$ Maximum $I^2\sqrt{t}$ for fusing	1830	1830	KA ² √s	t = 0.1 to 10ms, no voltage reapplied		
$V_{F(TO)1}$ Low level value of threshold voltage	0.95	0.95	V	$(16.7\% \times \pi \times I_{F(AV)} < I < \pi \times I_{F(AV)})$, $T_J = T_J$ max.		
$V_{F(TO)2}$ High level value of threshold voltage	1.00	1.00		$(I > \pi \times I_{F(AV)})$, $T_J = T_J$ max.		
r_{f1} Low level value of forward slope resistance	0.75	0.75	mΩ	$(16.7\% \times \pi \times I_{F(AV)} < I < \pi \times I_{F(AV)})$, $T_J = T_J$ max.		
r_{f2} High level value of forward slope resistance	0.72	0.72		$(I > \pi \times I_{F(AV)})$, $T_J = T_J$ max.		
V_{FM} Max. forward voltage drop	2.08	2.08	V	$I_{pk} = 1500A$, $T_J = T_J$ max, $t_p = 10ms$ sinusoidal wave		

Thermal and Mechanical Specifications

Parameter	SD300C..C		Units	Conditions
	04 to 20	25 to 32		
T _J Max. junction operating temperature range	-40 to 180	-40 to 150	°C	
T _{stg} Max. storage temperature range	-55 to 200	-55 to 200		
R _{thJ-hs} Max. thermal resistance, junction to heatsink	0.163 0.073		K/W	DC operation single side cooled DC operation double side cooled
F Mounting force, ± 10%	4900 (500)		N (Kg)	
wt Approximate weight	70		g	
Case style	DO-200AA			See Outline Table

ΔR_{thJ-hs} Conduction

(The following table shows the increment of thermal resistance R_{thJ-hs} when devices operate at different conduction angles than DC)

Conduction angle	Sinusoidal conduction		Rectangular conduction		Units	Conditions
	Single Side	Double Side	Single Side	Double Side		
180°	0.017	0.017	0.011	0.012	K/W	T _J = T _J max.
120°	0.020	0.020	0.020	0.020		
90°	0.025	0.025	0.027	0.027		
60°	0.036	0.036	0.038	0.038		
30°	0.064	0.062	0.065	0.062		

Ordering Information Table

Device Code

SD	30	0	C	32	C
①	②	③	④	⑤	⑥

- 1** - Diode
- 2** - Essential part number
- 3** - 0 = Standard recovery
- 4** - C = Ceramic Puk
- 5** - Voltage code: Code x 100 = V_{RRM} (See Voltage Ratings table)
- 6** - C = Puk Case DO-200AA

SD300C..C Series

Bulletin I2083 rev. C 04/00

Outline Table

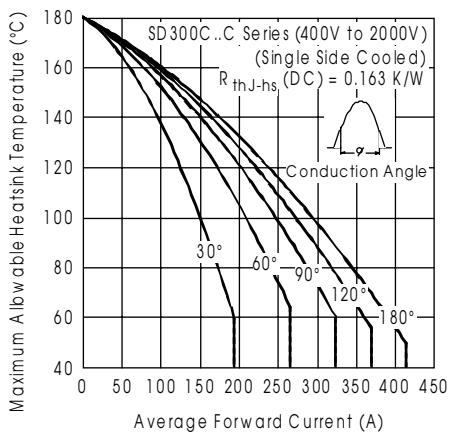
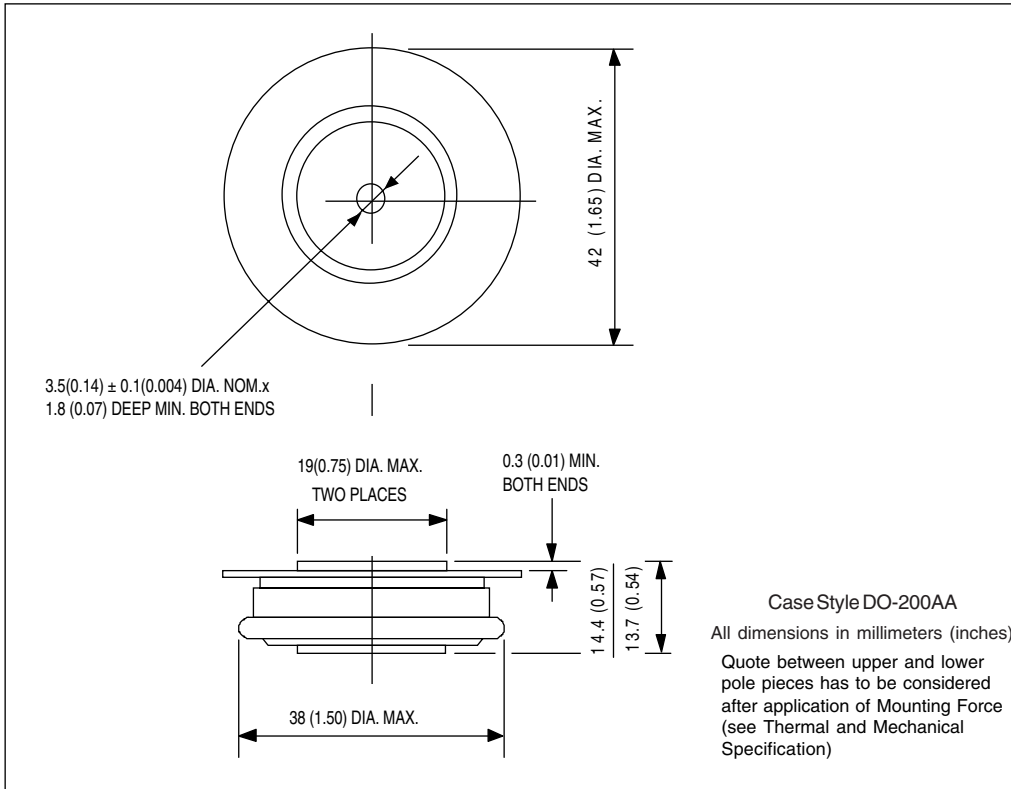

Fig. 1 - Current Ratings Characteristics

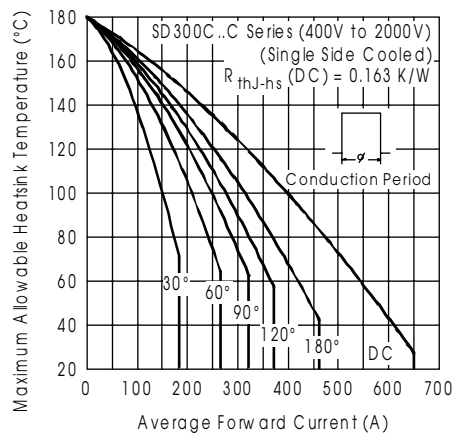

Fig. 2 - Current Ratings Characteristics

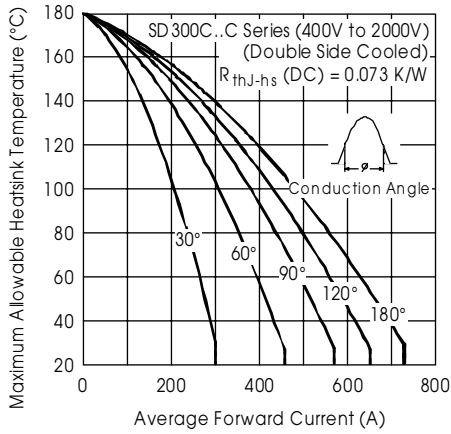

Fig. 3 - Current Ratings Characteristics

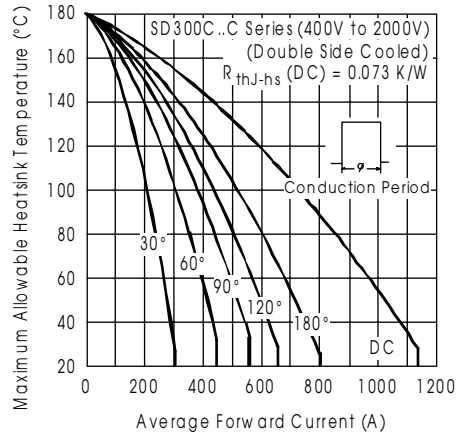

Fig. 4 - Current Ratings Characteristics

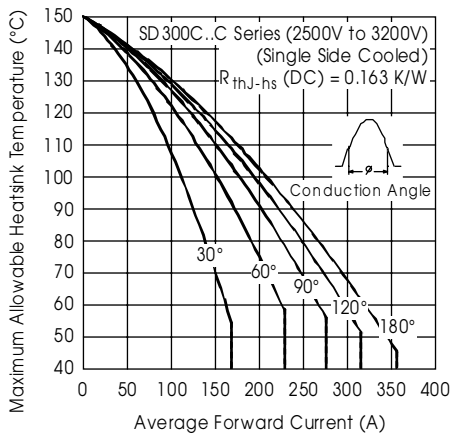

Fig. 5 - Current Ratings Characteristics

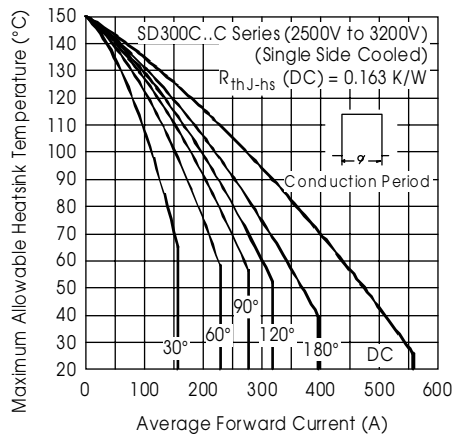

Fig. 6 - Current Ratings Characteristics

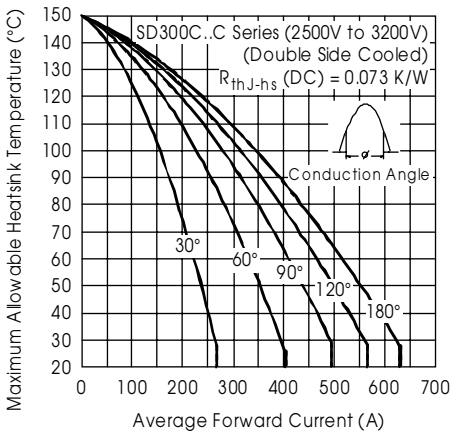

Fig. 7 - Current Ratings Characteristics

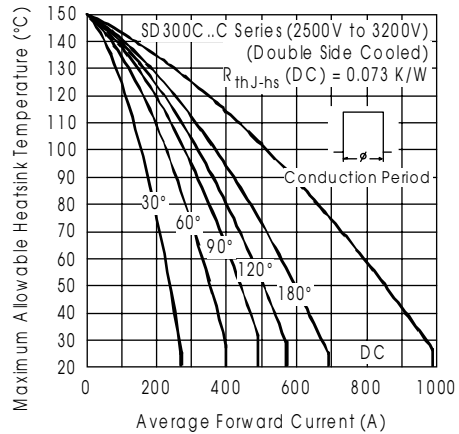

Fig. 8 - Current Ratings Characteristics

SD300C..C Series

Bulletin I2083 rev. C 04/00

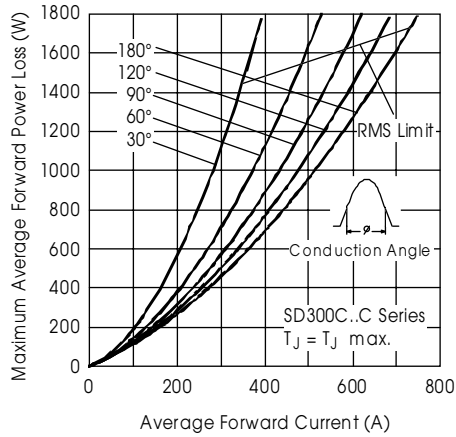

Fig. 9 - Forward Power Loss Characteristics

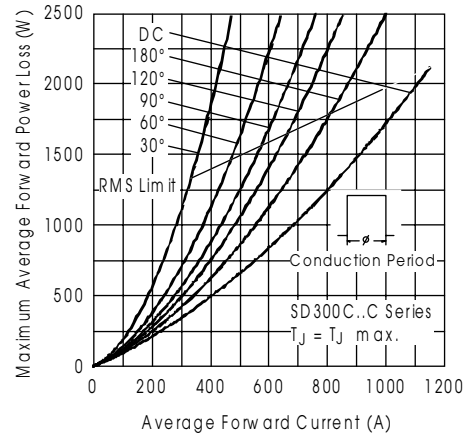

Fig. 10 - Forward Power Loss Characteristics

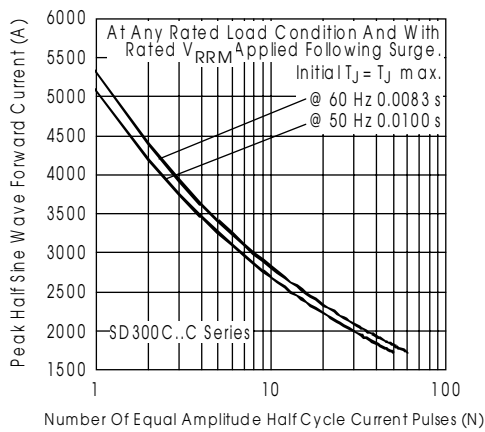

Fig. 11 - Maximum Non-Repetitive Surge Current Single and Double Side Cooled

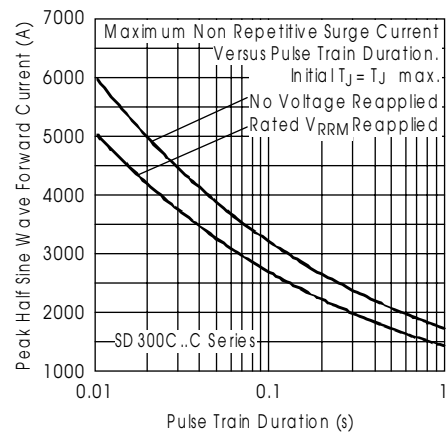

Fig. 12 - Maximum Non-Repetitive Surge Current Single and Double Side Cooled

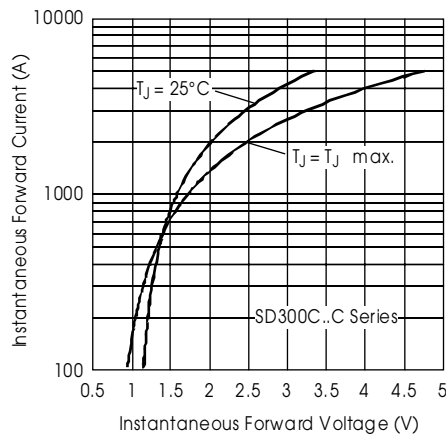

Fig. 13 - Forward Voltage Drop Characteristics

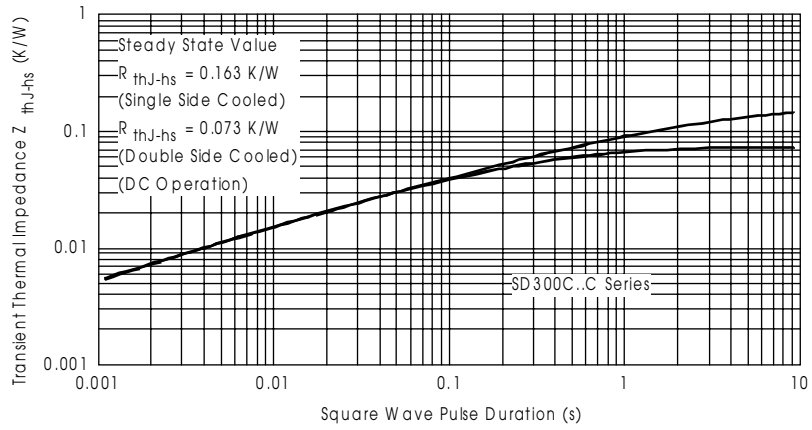

Fig. 14 - Thermal Impedance Z_{thJC} Characteristics